

# TPS76715-Q1, TPS76718-Q1, TPS76725-Q1, TPS76727-Q1 TPS76728-Q1, TPS76730-Q1, TPS76733-Q1, TPS76750-Q1, TPS76701-Q1 FAST-TRANSIENT-RESPONSE 1-A LOW-DROPOUT VOLTAGE REGULATORS

SGLS009A – MARCH 2003 – REVISED AUGUST 2007

- Qualification in Accordance With AEC-Q100†
- Qualified for Automotive Applications
- Customer-Specific Configuration Control Can Be Supported Along With Major-Change Approval
- ESD Protection Exceeds 2000 V Per MIL-STD-883, Method 3015; Exceeds 200 V Using Machine Model (C = 200 pF, R = 0)
- 1-A Low-Dropout (LDO) Voltage Regulator
- Available in 1.5-V, 1.8-V, 2.5-V, 2.7-V, 2.8-V, 3-V, 3.3-V, 5-V Fixed-Output and Adjustable Versions
- Dropout Voltage Down to 230 mV at 1 A (TPS76750)
- Ultralow 85- $\mu$ A Typical Quiescent Current
- Fast Transient Response
- 2% Tolerance Over Specified Conditions for Fixed-Output Versions
- Open Drain Power-On Reset With 200-ms Delay (See TPS768xx for PG Option)
- 20-Pin TSSOP PowerPAD™ (PWP) Package
- Thermal Shutdown Protection

† Contact factory for details. Q100 qualification data available on request.

PWP PACKAGE  
(TOP VIEW)

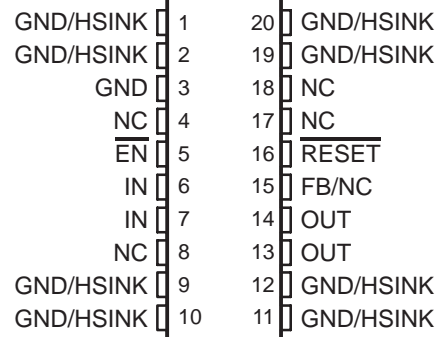

NC – No internal connection

## description

These devices are designed to have a fast transient response and be stable with 10- $\mu$ F low ESR capacitors. This combination provides high performance at a reasonable cost.

Because the PMOS device behaves as a low-value resistor, the dropout voltage is very low (typically 230 mV at an output current of 1 A for the TPS76750) and is directly proportional to the output current. Additionally, since the PMOS pass element is a voltage-driven device, the quiescent current is very low and independent of output loading (typically 85  $\mu$ A over the full range of output current, 0 mA to 1 A). These two key specifications yield a significant improvement in operating life for battery-powered systems. This low-dropout (LDO) family also features a sleep mode; applying a TTL high signal to the enable ( $\overline{\text{EN}}$ ) input shuts down the regulator, reducing the quiescent current to 1  $\mu$ A at  $T_J = 25^\circ\text{C}$ .

The  $\overline{\text{RESET}}$  output of the TPS767xx initiates a reset in microcomputer and microprocessor systems in the event of an undervoltage condition. An internal comparator in the TPS767xx monitors the output voltage of the regulator to detect an undervoltage condition on the regulated output voltage.

The TPS767xx is offered in 1.5-V, 1.8-V, 2.5-V, 2.7-V, 2.8-V, 3-V, 3.3-V, and 5-V fixed-voltage versions and in an adjustable version (programmable over the range of 1.5 V to 5.5 V). Output voltage tolerance is specified as a maximum of 2% over line, load, and temperature ranges. The TPS767xx family is available in a 20-pin PWP package.



Please be aware that an important notice concerning availability, standard warranty, and use in critical applications of Texas Instruments semiconductor products and disclaimers thereto appears at the end of this data sheet.

PowerPAD is a trademark of Texas Instruments.

PRODUCTION DATA information is current as of publication date. Products conform to specifications per the terms of Texas Instruments standard warranty. Production processing does not necessarily include testing of all parameters.



POST OFFICE BOX 655303 • DALLAS, TEXAS 75265

Copyright © 2007, Texas Instruments Incorporated

**TPS76715-Q1, TPS76718-Q1, TPS76725-Q1, TPS76727-Q1  
 TPS76728-Q1, TPS76730-Q1, TPS76733-Q1, TPS76750-Q1, TPS76701-Q1  
 FAST-TRANSIENT-RESPONSE 1-A LOW-DROPOUT VOLTAGE REGULATORS**

SGLS009A – MARCH 2003 – REVISED AUGUST 2007

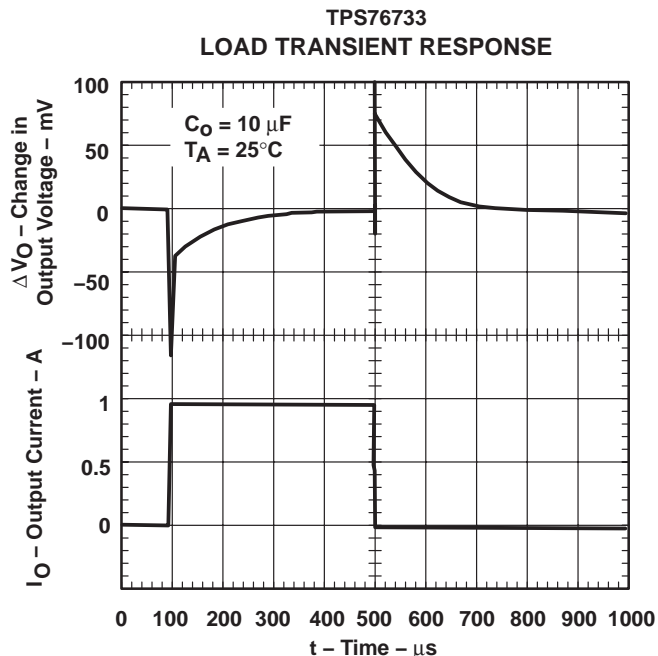
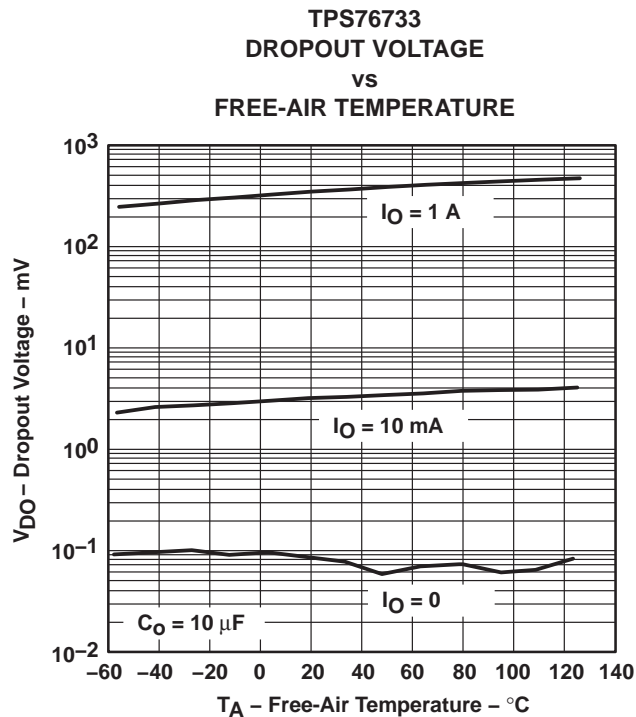

**AVAILABLE OPTIONS†**

T <sub>J</sub>	OUTPUT VOLTAGE (V)	TSSOP (PWP)‡
	TYP	
-40°C to 125°C	5	TPS76750QPWPRQ1
	3.3	TPS76733QPWPRQ1
	3	TPS76730QPWPRQ1§
	2.8	TPS76728QPWPRQ1§
	2.7	TPS76727QPWPRQ1§
	2.5	TPS76725QPWPRQ1
	1.8	TPS76718QPWPRQ1
	1.5	TPS76715QPWPRQ1
	Adjustable 1.5 V to 5.5 V	TPS76701QPWPRQ1

† For the most current package and ordering information, see the Package Option Addendum at the end of this document, or see the TI web site at [www.ti.com](http://www.ti.com).

‡ Available taped and reeled in quantities of 2000 per reel

§ This devices is product preview.

**TPS76715-Q1, TPS76718-Q1, TPS76725-Q1, TPS76727-Q1  
 TPS76728-Q1, TPS76730-Q1, TPS76733-Q1, TPS76750-Q1, TPS76701-Q1  
 FAST-TRANSIENT-RESPONSE 1-A LOW-DROPOUT VOLTAGE REGULATORS**

SGLS009A – MARCH 2003 – REVISED AUGUST 2007

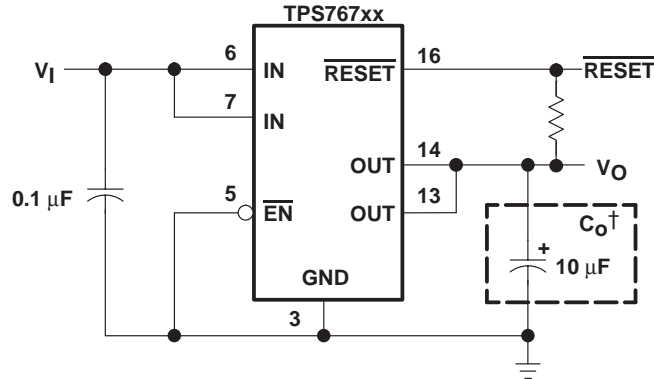

† See application information section for capacitor selection details.

**Figure 1. Typical Application Configuration (for Fixed Output Options)**

**functional block diagram—adjustable version**

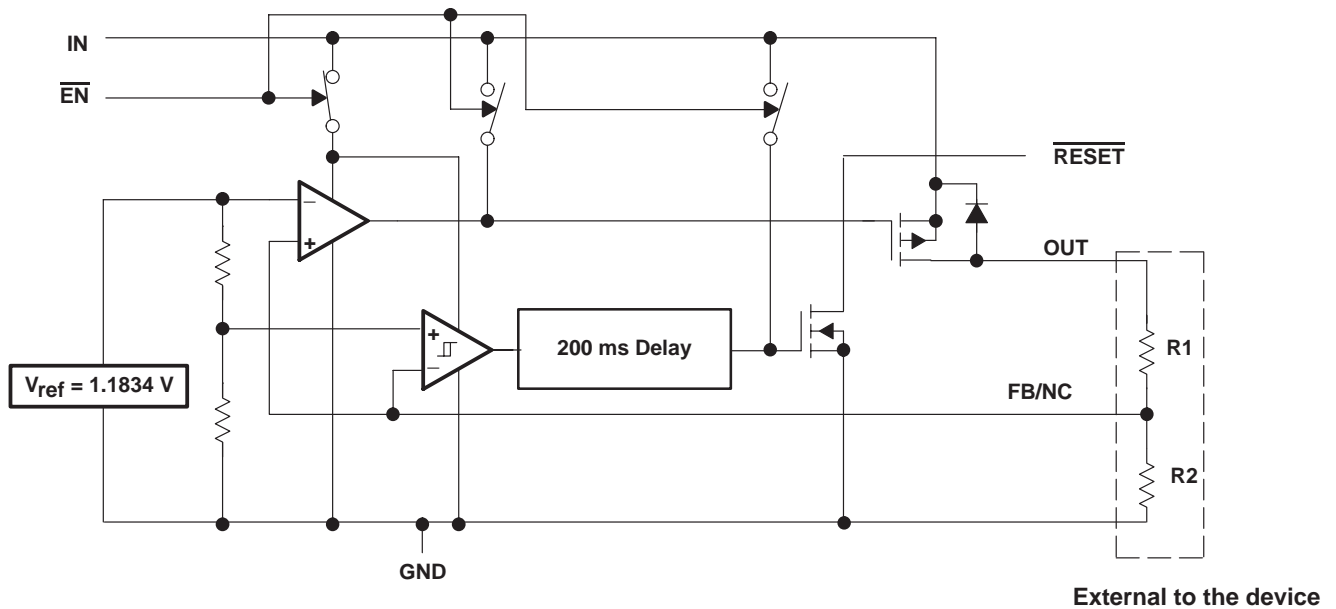

**TPS76715-Q1, TPS76718-Q1, TPS76725-Q1, TPS76727-Q1  
 TPS76728-Q1, TPS76730-Q1, TPS76733-Q1, TPS76750-Q1, TPS76701-Q1  
 FAST-TRANSIENT-RESPONSE 1-A LOW-DROPOUT VOLTAGE REGULATORS**

SGLS009A – MARCH 2003 – REVISED AUGUST 2007

**functional block diagram—fixed-voltage version**

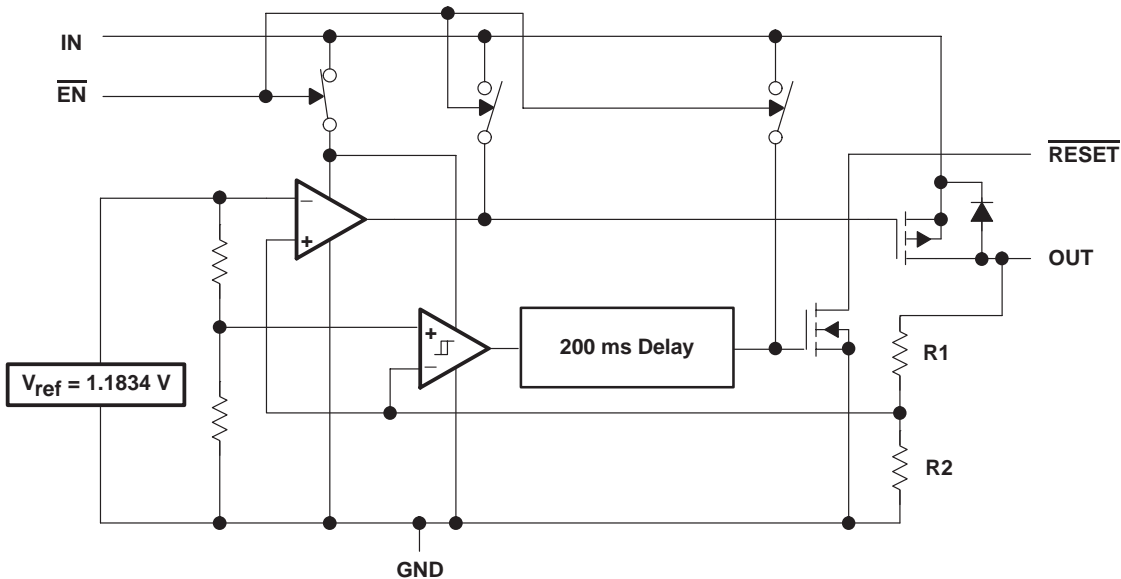

**Terminal Functions**

TERMINAL NAME	NO.	I/O	DESCRIPTION
EN	5	I	Enable
FB/NC	15	I	Feedback voltage for adjustable device (no connect for fixed options)
GND	3		Regulator ground
GND/HSINK	1, 2, 9, 10, 11, 12, 19, 20		Ground/heatsink
IN	6, 7	I	Input voltage
NC	4, 8, 17, 18		No connect
OUT	13, 14	O	Regulated output voltage
RESET	16	O	Reset



**TPS76715-Q1, TPS76718-Q1, TPS76725-Q1, TPS76727-Q1  
 TPS76728-Q1, TPS76730-Q1, TPS76733-Q1, TPS76750-Q1, TPS76701-Q1  
 FAST-TRANSIENT-RESPONSE 1-A LOW-DROPOUT VOLTAGE REGULATORS**

SGLS009A – MARCH 2003 – REVISED AUGUST 2007

**timing diagram**

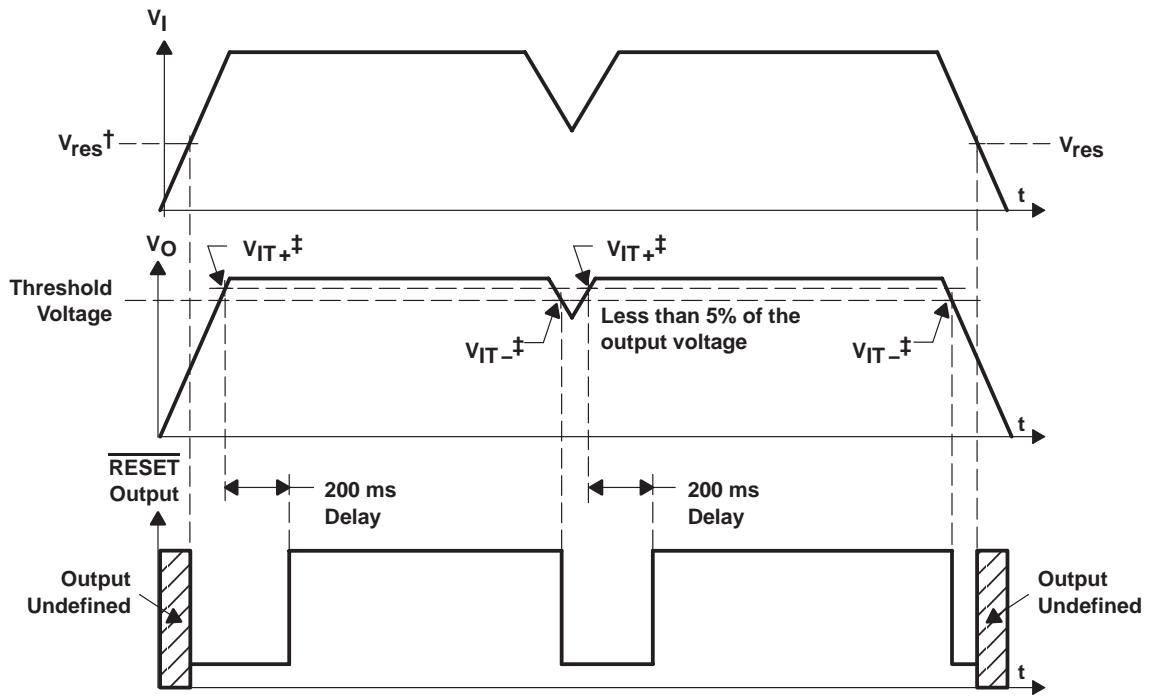

$^\dagger V_{res}$  is the minimum input voltage for a valid  $\overline{\text{RESET}}$ . The symbol  $V_{res}$  is not currently listed within EIA or JEDEC standards for semiconductor symbology.

$^\ddagger V_{IT-}$  – Trip voltage is typically 5% lower than the output voltage ( $95\%V_O$ )  $V_{IT-}$  to  $V_{IT+}$  is the hysteresis voltage.

**TPS76715-Q1, TPS76718-Q1, TPS76725-Q1, TPS76727-Q1  
 TPS76728-Q1, TPS76730-Q1, TPS76733-Q1, TPS76750-Q1, TPS76701-Q1  
 FAST-TRANSIENT-RESPONSE 1-A LOW-DROPOUT VOLTAGE REGULATORS**

SGLS009A – MARCH 2003 – REVISED AUGUST 2007

**absolute maximum ratings over operating free-air temperature range (unless otherwise noted)†**

Input voltage range‡, $V_I$ .....	-0.3 V to 13.5 V
Voltage range at EN .....	-0.3 V to $V_I + 0.3$ V
Maximum RESET voltage .....	16.5 V
Peak output current .....	Internally limited
Output voltage, $V_O$ (OUT, FB) .....	7 V
Continuous total power dissipation .....	See dissipation rating tables
Operating virtual junction temperature range, $T_J$ .....	-40°C to 125°C
Storage temperature range, $T_{stg}$ .....	-65°C to 150°C
ESD rating, Human-Body Model (HBM) .....	2 kV

† Stresses beyond those listed under “absolute maximum ratings” may cause permanent damage to the device. These are stress ratings only, and functional operation of the device at these or any other conditions beyond those indicated under “recommended operating conditions” is not implied. Exposure to absolute-maximum-rated conditions for extended periods may affect device reliability.

‡ All voltage values are with respect to network terminal ground.

**DISSIPATION RATING TABLE – FREE-AIR TEMPERATURES**

PACKAGE	AIR FLOW (CFM)	$T_A < 25^\circ\text{C}$ POWER RATING	DERATING FACTOR ABOVE $T_A = 25^\circ\text{C}$	$T_A = 70^\circ\text{C}$ POWER RATING	$T_A = 85^\circ\text{C}$ POWER RATING
PWP§	0	2.9 W	23.5 mW/°C	1.9 W	1.5 W
	300	4.3 W	34.6 mW/°C	2.8 W	2.2 W
PWP¶	0	3 W	23.8 mW/°C	1.9 W	1.5 W
	300	7.2 W	57.9 mW/°C	4.6 W	3.8 W

§ This parameter is measured with the recommended copper heat-sink pattern on a 1-layer PCB, 5-in × 5-in PCB, 1-oz copper, 2-in × 2-in coverage (4 in<sup>2</sup>).

¶ This parameter is measured with the recommended copper heat sink pattern on a 8-layer PCB, 1.5-in × 2-in PCB, 1-oz copper with layers 1, 2, 4, 5, 7, and 8 at 5% coverage (0.9 in<sup>2</sup>) and layers 3 and 6 at 100% coverage (6 in<sup>2</sup>). For more information, refer to TI technical brief SLMA002.

**recommended operating conditions**

	MIN	MAX	UNIT
Input voltage, $V_I$ #	2.7	10	V
Output voltage range, $V_O$	1.5	5.5	V
Output current, $I_O$ (see Note 1)	0	1.0	A
Operating virtual junction temperature, $T_J$ (see Note 1)	-40	125	°C

# To calculate the minimum input voltage for your maximum output current, use the following equation:  $V_{I(\min)} = V_{O(\max)} + V_{DO(\max \text{ load})}$ .  
 NOTE 1: Continuous current and operating junction temperature are limited by internal protection circuitry, but it is not recommended that the device operate under conditions beyond those specified in this table for extended periods of time.



**TPS76715-Q1, TPS76718-Q1, TPS76725-Q1, TPS76727-Q1  
TPS76728-Q1, TPS76730-Q1, TPS76733-Q1, TPS76750-Q1, TPS76701-Q1  
FAST-TRANSIENT-RESPONSE 1-A LOW-DROPOUT VOLTAGE REGULATORS**

SGLS009A – MARCH 2003 – REVISED AUGUST 2007

**electrical characteristics over recommended operating free-air temperature range,  
 $V_I = V_{O(\text{typ})} + 1 \text{ V}$ ,  $I_O = 1 \text{ mA}$ ,  $\overline{EN} = 0 \text{ V}$ ,  $C_O = 10 \mu\text{F}$  (unless otherwise noted)**

PARAMETER		TEST CONDITIONS	MIN	TYP	MAX	UNIT
Output voltage (10 $\mu\text{A}$ to 1 A load) (see Note 2)	TPS76701	$1.5 \text{ V} \leq V_O \leq 5.5 \text{ V}$ , $T_J = 25^\circ\text{C}$		$V_O$		V
		$1.5 \text{ V} \leq V_O \leq 5.5 \text{ V}$ , $T_J = -40^\circ\text{C}$ to $125^\circ\text{C}$	$0.98V_O$		$1.02V_O$	
	TPS76715	$T_J = 25^\circ\text{C}$ , $2.7 \text{ V} < V_{IN} < 10 \text{ V}$		1.5		
		$T_J = -40^\circ\text{C}$ to $125^\circ\text{C}$ , $2.7 \text{ V} < V_{IN} < 10 \text{ V}$	1.470		1.530	
	TPS76718	$T_J = 25^\circ\text{C}$ , $2.8 \text{ V} < V_{IN} < 10 \text{ V}$		1.8		
		$T_J = -40^\circ\text{C}$ to $125^\circ\text{C}$ , $2.8 \text{ V} < V_{IN} < 10 \text{ V}$	1.764		1.836	
	TPS76725	$T_J = 25^\circ\text{C}$ , $3.5 \text{ V} < V_{IN} < 10 \text{ V}$		2.5		
		$T_J = -40^\circ\text{C}$ to $125^\circ\text{C}$ , $3.5 \text{ V} < V_{IN} < 10 \text{ V}$	2.450		2.550	
	TPS76727	$T_J = 25^\circ\text{C}$ , $3.7 \text{ V} < V_{IN} < 10 \text{ V}$		2.7		
		$T_J = -40^\circ\text{C}$ to $125^\circ\text{C}$ , $3.7 \text{ V} < V_{IN} < 10 \text{ V}$	2.646		2.754	
	TPS76728	$T_J = 25^\circ\text{C}$ , $3.8 \text{ V} < V_{IN} < 10 \text{ V}$		2.8		
		$T_J = -40^\circ\text{C}$ to $125^\circ\text{C}$ , $3.8 \text{ V} < V_{IN} < 10 \text{ V}$	2.744		2.856	
	TPS76730	$T_J = 25^\circ\text{C}$ , $4.0 \text{ V} < V_{IN} < 10 \text{ V}$		3.0		
		$T_J = -40^\circ\text{C}$ to $125^\circ\text{C}$ , $4.0 \text{ V} < V_{IN} < 10 \text{ V}$	2.940		3.060	
	TPS76733	$T_J = 25^\circ\text{C}$ , $4.3 \text{ V} < V_{IN} < 10 \text{ V}$		3.3		
		$T_J = -40^\circ\text{C}$ to $125^\circ\text{C}$ , $4.3 \text{ V} < V_{IN} < 10 \text{ V}$	3.234		3.366	
	TPS76750	$T_J = 25^\circ\text{C}$ , $6.0 \text{ V} < V_{IN} < 10 \text{ V}$		5.0		
		$T_J = -40^\circ\text{C}$ to $125^\circ\text{C}$ , $6.0 \text{ V} < V_{IN} < 10 \text{ V}$	4.900		5.100	
Quiescent current (GND current) $\overline{EN} = 0 \text{ V}$ , (see Note 2)		$10 \mu\text{A} < I_O < 1 \text{ A}$ , $T_J = 25^\circ\text{C}$		85		$\mu\text{A}$
		$I_O = 1 \text{ A}$ , $T_J = -40^\circ\text{C}$ to $125^\circ\text{C}$			125	
Output voltage line regulation ( $\Delta V_O/V_O$ ) (see Notes 2 and 3)		$V_O + 1 \text{ V} < V_I \leq 10 \text{ V}$ , $T_J = 25^\circ\text{C}$		0.01		%/V
Load regulation				3		mV
Output noise voltage (TPS76718)		$BW = 200 \text{ Hz}$ to $100 \text{ kHz}$ , $I_C = 1 \text{ A}$ , $C_O = 10 \mu\text{F}$ , $T_J = 25^\circ\text{C}$		55		$\mu\text{V}_{\text{rms}}$
Output current limit		$V_O = 0 \text{ V}$		1.7	2	A
Thermal shutdown junction temperature				150		$^\circ\text{C}$
Standby current		$\overline{EN} = V_I$ , $T_J = 25^\circ\text{C}$ , $2.7 \text{ V} < V_I < 10 \text{ V}$		1		$\mu\text{A}$
		$\overline{EN} = V_I$ , $T_J = -40^\circ\text{C}$ to $125^\circ\text{C}$ , $2.7 \text{ V} < V_I < 10 \text{ V}$			10	
FB input current	TPS76701	$FB = 1.5 \text{ V}$		2		nA
High-level enable input voltage				1.7		V
Low-level enable input voltage					0.9	V
Power-supply ripple rejection (see Note 2)		$f = 1 \text{ KHz}$ , $C_O = 10 \mu\text{F}$ , $T_J = 25^\circ\text{C}$		60		dB

NOTES: 2. Minimum IN operating voltage is 2.7 V or  $V_{O(\text{typ})} + 1 \text{ V}$ , whichever is greater. Maximum IN voltage 10 V.

3. If  $V_O \leq 1.8 \text{ V}$  then  $V_{I\text{max}} = 10 \text{ V}$ ,  $V_{I\text{min}} = 2.7 \text{ V}$ :

$$\text{Line Regulation (mV)} = (\%/V) \times \frac{V_O(V_{I\text{max}} - 2.7 \text{ V})}{100} \times 1000$$

If  $V_O \geq 2.5 \text{ V}$  then  $V_{I\text{max}} = 10 \text{ V}$ ,  $V_{I\text{min}} = V_O + 1 \text{ V}$ :

$$\text{Line Regulation (mV)} = (\%/V) \times \frac{V_O(V_{I\text{max}} - (V_O + 1 \text{ V}))}{100} \times 1000$$



**TPS76715-Q1, TPS76718-Q1, TPS76725-Q1, TPS76727-Q1  
 TPS76728-Q1, TPS76730-Q1, TPS76733-Q1, TPS76750-Q1, TPS76701-Q1  
 FAST-TRANSIENT-RESPONSE 1-A LOW-DROPOUT VOLTAGE REGULATORS**

SGLS009A – MARCH 2003 – REVISED AUGUST 2007

electrical characteristics over recommended operating free-air temperature range,  $V_I = V_O(\text{typ}) + 1 \text{ V}$ ,  $I_O = 1 \text{ mA}$ ,  $\overline{\text{EN}} = 0 \text{ V}$ ,  $C_O = 10 \mu\text{F}$  (unless otherwise noted) (continued)

PARAMETER		TEST CONDITIONS	MIN	TYP	MAX	UNIT
Reset	Minimum input voltage for valid $\overline{\text{RESET}}$	$I_O(\text{RESET}) = 300 \mu\text{A}$		1.1		V
	Trip threshold voltage	$V_O$ decreasing	92		98	% $V_O$
	Hysteresis voltage	Measured at $V_O$		0.5		% $V_O$
	Output low voltage	$V_I = 2.7 \text{ V}$ , $I_O(\text{RESET}) = 1 \text{ mA}$		0.15	0.4	V
	Leakage current	$V(\text{RESET}) = 5 \text{ V}$			1	$\mu\text{A}$
	RESET time-out delay			200		ms
Input current ( $\overline{\text{EN}}$ )		$\overline{\text{EN}} = 0 \text{ V}$	-1	0	1	$\mu\text{A}$
		$\overline{\text{EN}} = V_I$	-1		1	
Dropout voltage (see Note 4)		TPS76728	$I_O = 1 \text{ A}$ , $T_J = 25^\circ\text{C}$	500		mV
			$I_O = 1 \text{ A}$ , $T_J = -40^\circ\text{C}$ to $125^\circ\text{C}$	825		
		TPS76730	$I_O = 1 \text{ A}$ , $T_J = 25^\circ\text{C}$	450		
			$I_O = 1 \text{ A}$ , $T_J = -40^\circ\text{C}$ to $125^\circ\text{C}$	675		
		TPS76733	$I_O = 1 \text{ A}$ , $T_J = 25^\circ\text{C}$	350		
			$I_O = 1 \text{ A}$ , $T_J = -40^\circ\text{C}$ to $125^\circ\text{C}$	575		
		TPS76750	$I_O = 1 \text{ A}$ , $T_J = 25^\circ\text{C}$	230		
			$I_O = 1 \text{ A}$ , $T_J = -40^\circ\text{C}$ to $125^\circ\text{C}$	380		

NOTE 4:  $I_N$  voltage equals  $V_O(\text{typ}) - 100 \text{ mV}$ ; TPS76701 output voltage set to 3.3 V nominal with external resistor divider. TPS76715, TPS76718, TPS76725, and TPS76727 dropout voltage limited by input voltage range limitations (i.e., TPS76730 input voltage needs to drop to 2.9 V for purpose of this test).

**TYPICAL CHARACTERISTICS**

**Table of Graphs**

			FIGURE
$V_O$	Output voltage	vs Output current	2, 3, 4
		vs Free-air temperature	5, 6, 7
	Ground current	vs Free-air temperature	8, 9
	Power-supply ripple rejection	vs Frequency	10
	Output spectral noise density	vs Frequency	11
	Input voltage (min)	vs Output voltage	12
$Z_O$	Output impedance	vs Frequency	13
$V_{DO}$	Dropout voltage	vs Free-air temperature	14
	Line transient response		15, 17
	Load transient response		16, 18
$V_O$	Output voltage	vs Time	19
		Dropout voltage	vs Input voltage
	Equivalent series resistance (ESR)	vs Output current	22–25





**TPS76715-Q1, TPS76718-Q1, TPS76725-Q1, TPS76727-Q1  
 TPS76728-Q1, TPS76730-Q1, TPS76733-Q1, TPS76750-Q1, TPS76701-Q1  
 FAST-TRANSIENT-RESPONSE 1-A LOW-DROPOUT VOLTAGE REGULATORS**

SGLS009A – MARCH 2003 – REVISED AUGUST 2007

**TYPICAL CHARACTERISTICS**

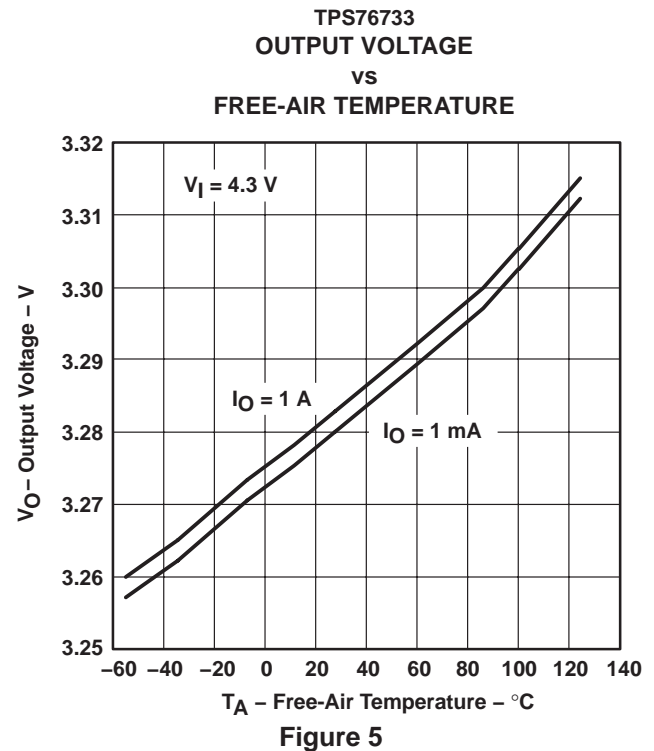
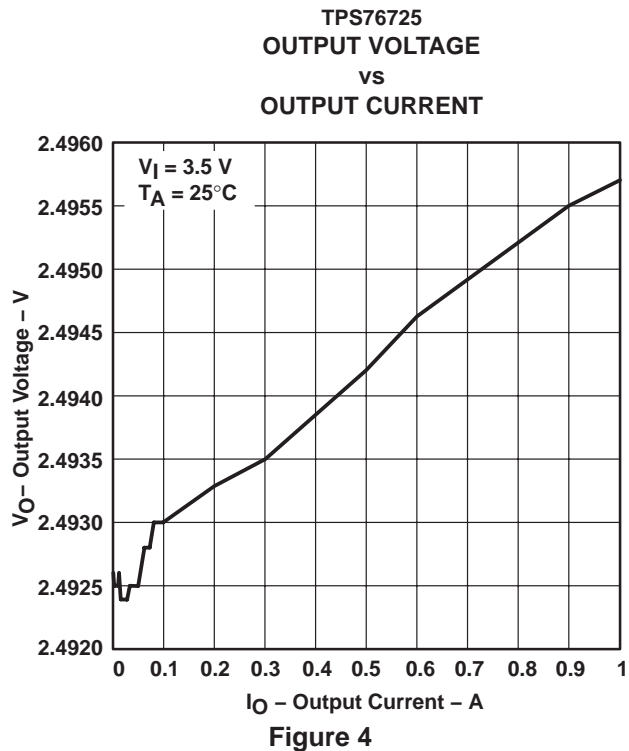
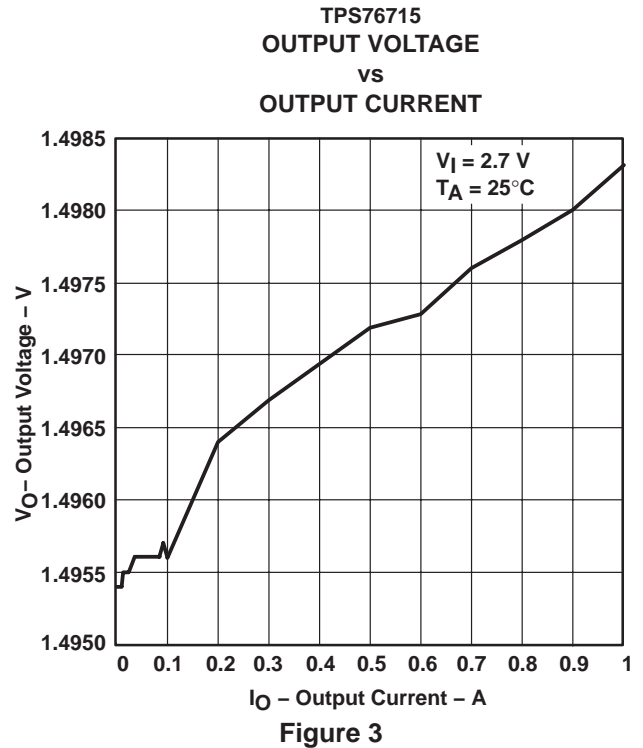
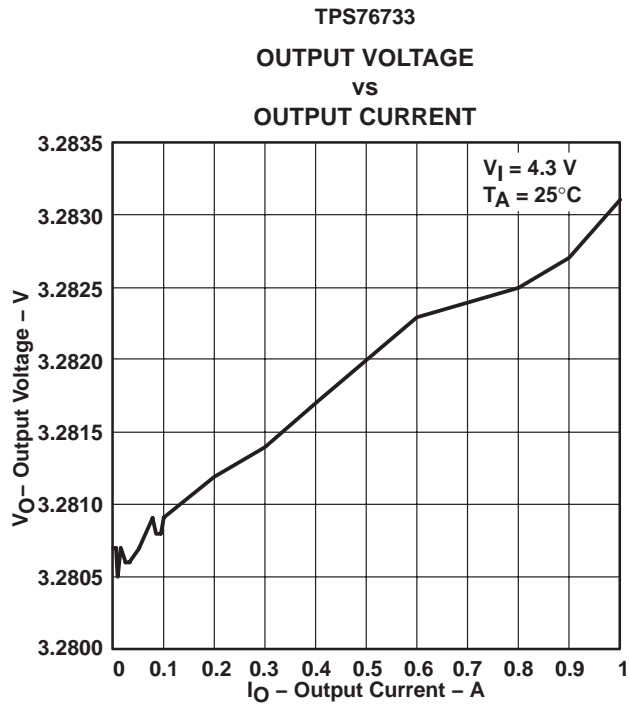

**TPS76715-Q1, TPS76718-Q1, TPS76725-Q1, TPS76727-Q1  
 TPS76728-Q1, TPS76730-Q1, TPS76733-Q1, TPS76750-Q1, TPS76701-Q1  
 FAST-TRANSIENT-RESPONSE 1-A LOW-DROPOUT VOLTAGE REGULATORS**

SGLS009A – MARCH 2003 – REVISED AUGUST 2007

**TYPICAL CHARACTERISTICS**

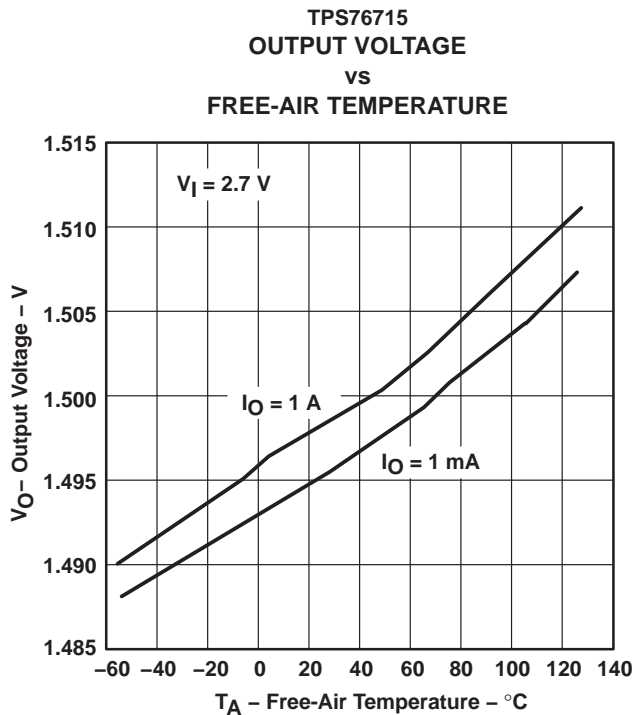

Figure 6

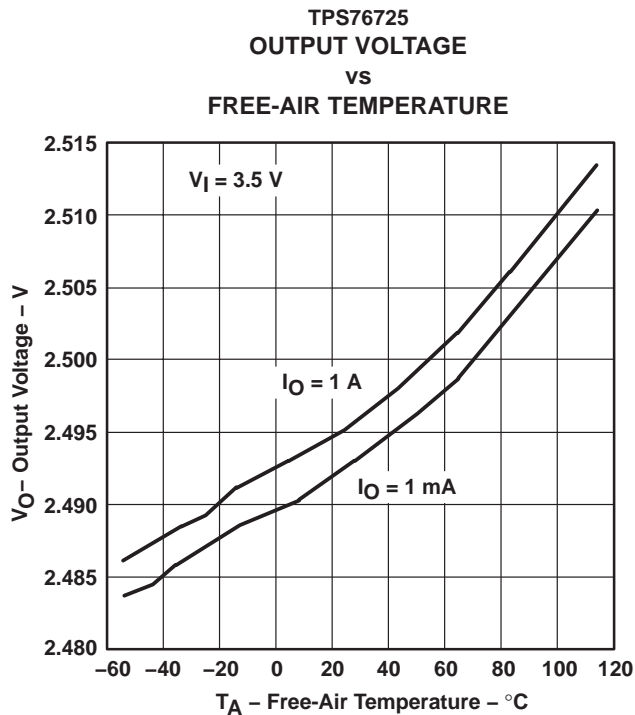

Figure 7

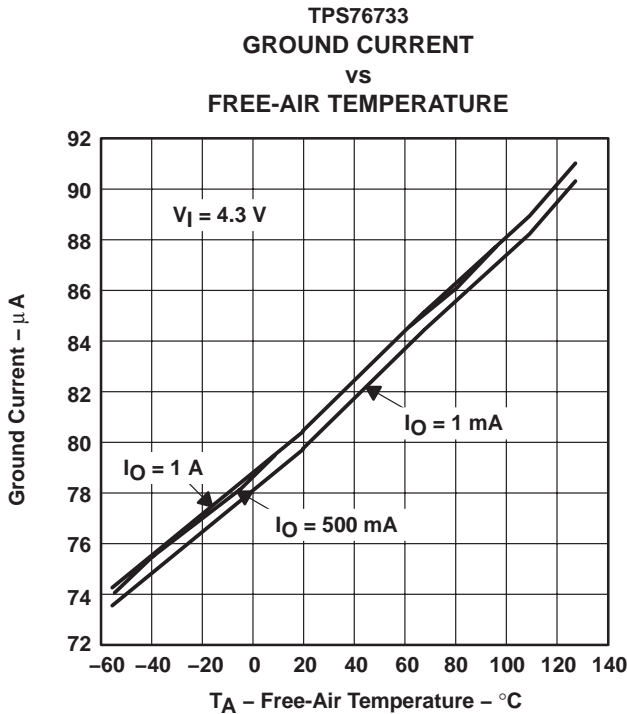

Figure 8



**TPS76715-Q1, TPS76718-Q1, TPS76725-Q1, TPS76727-Q1  
 TPS76728-Q1, TPS76730-Q1, TPS76733-Q1, TPS76750-Q1, TPS76701-Q1  
 FAST-TRANSIENT-RESPONSE 1-A LOW-DROPOUT VOLTAGE REGULATORS**

SGLS009A – MARCH 2003 – REVISED AUGUST 2007

**TYPICAL CHARACTERISTICS**

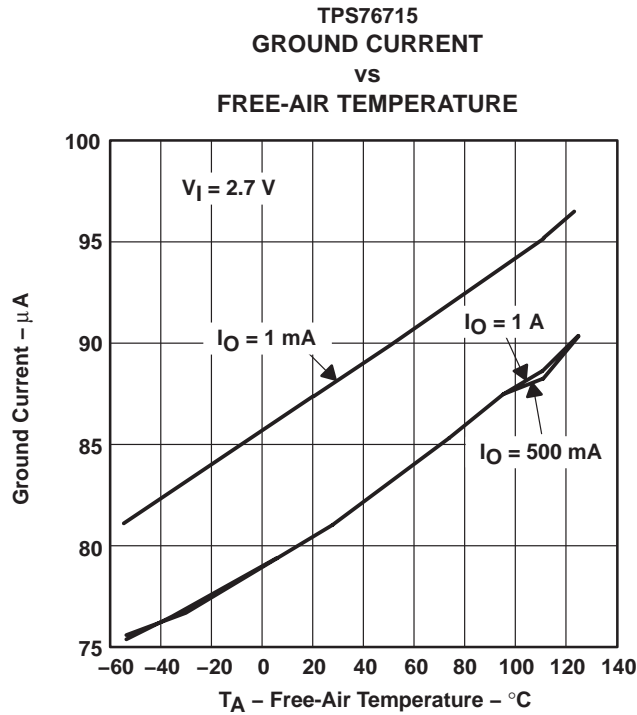

**Figure 9**

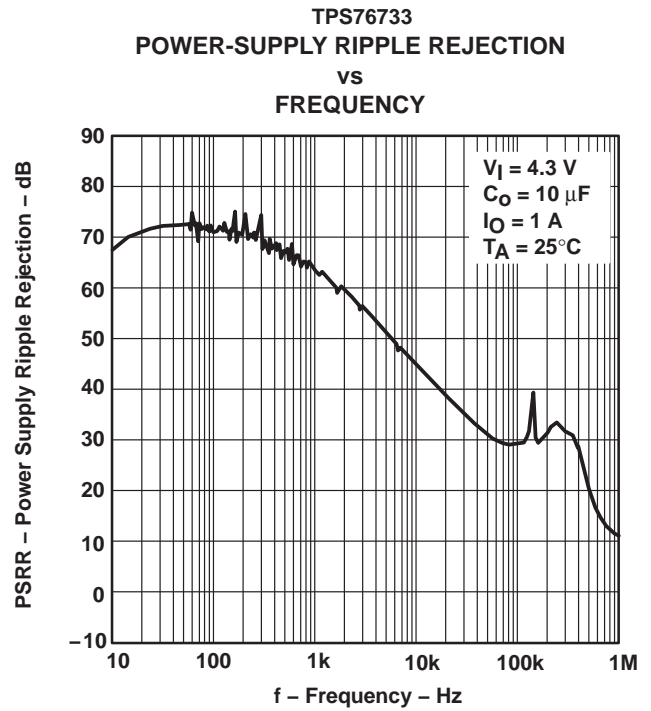

**Figure 10**

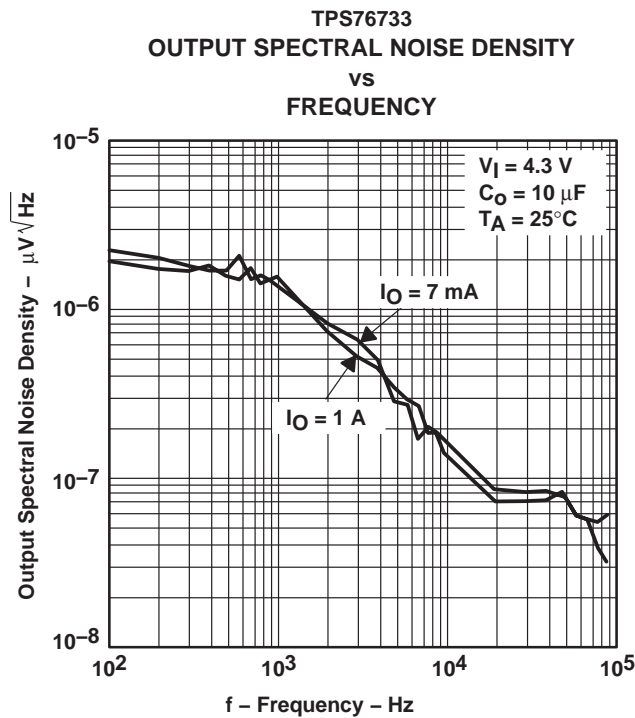

**Figure 11**



**TPS76715-Q1, TPS76718-Q1, TPS76725-Q1, TPS76727-Q1  
 TPS76728-Q1, TPS76730-Q1, TPS76733-Q1, TPS76750-Q1, TPS76701-Q1  
 FAST-TRANSIENT-RESPONSE 1-A LOW-DROPOUT VOLTAGE REGULATORS**

SGLS009A – MARCH 2003 – REVISED AUGUST 2007

**TYPICAL CHARACTERISTICS**

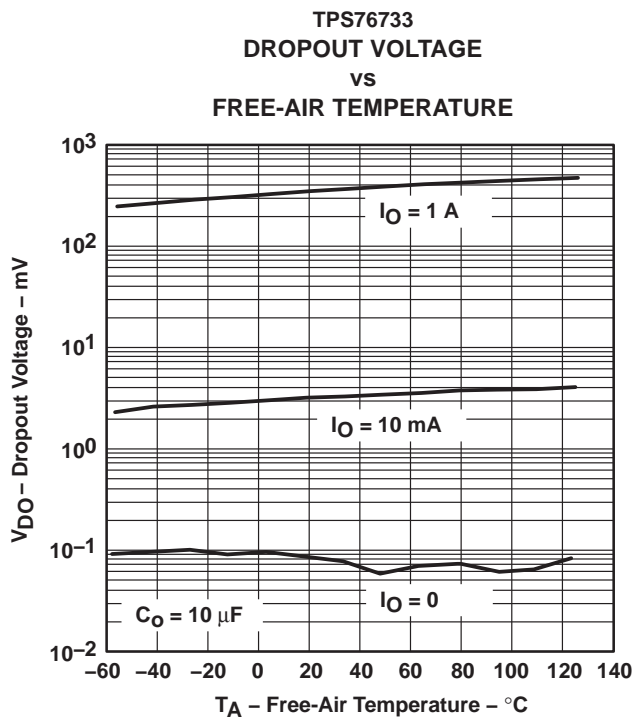
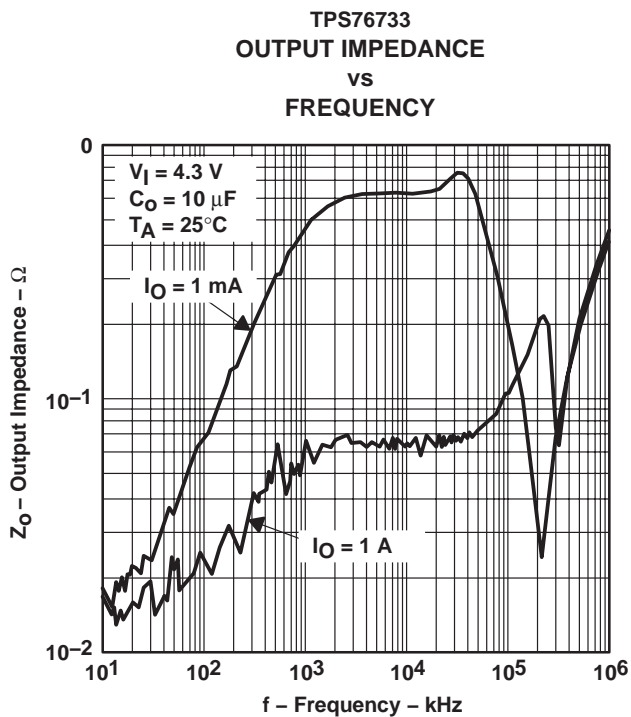
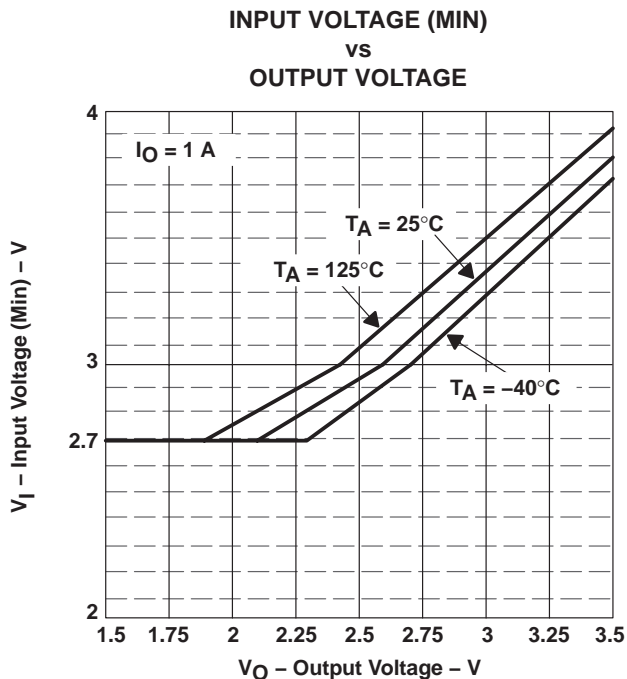

**TPS76715-Q1, TPS76718-Q1, TPS76725-Q1, TPS76727-Q1  
 TPS76728-Q1, TPS76730-Q1, TPS76733-Q1, TPS76750-Q1, TPS76701-Q1  
 FAST-TRANSIENT-RESPONSE 1-A LOW-DROPOUT VOLTAGE REGULATORS**

SGLS009A – MARCH 2003 – REVISED AUGUST 2007

**TYPICAL CHARACTERISTICS**

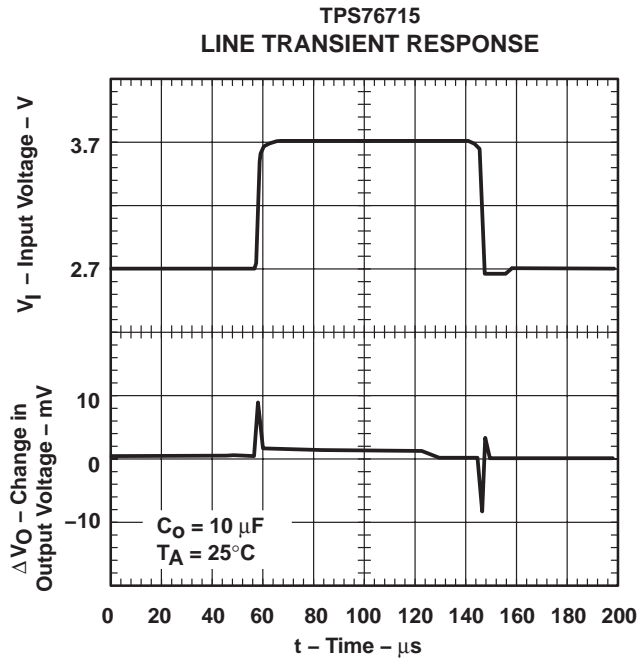

**Figure 15**

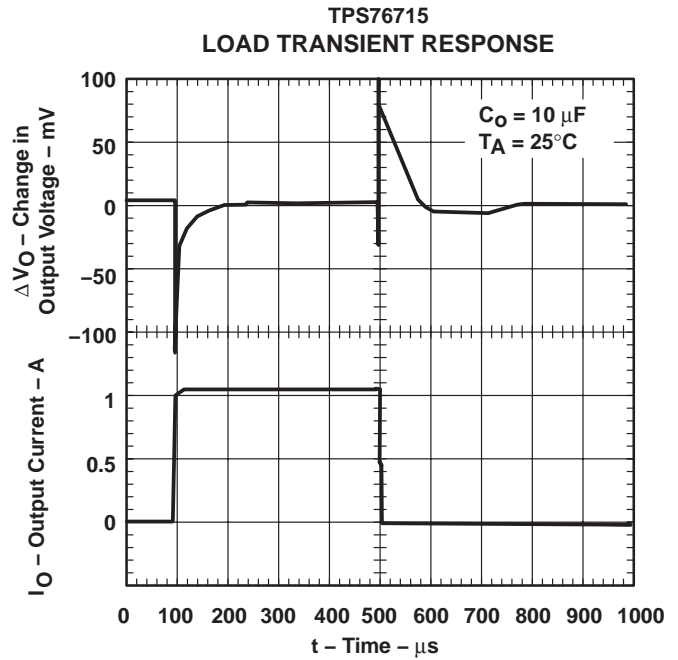

**Figure 16**

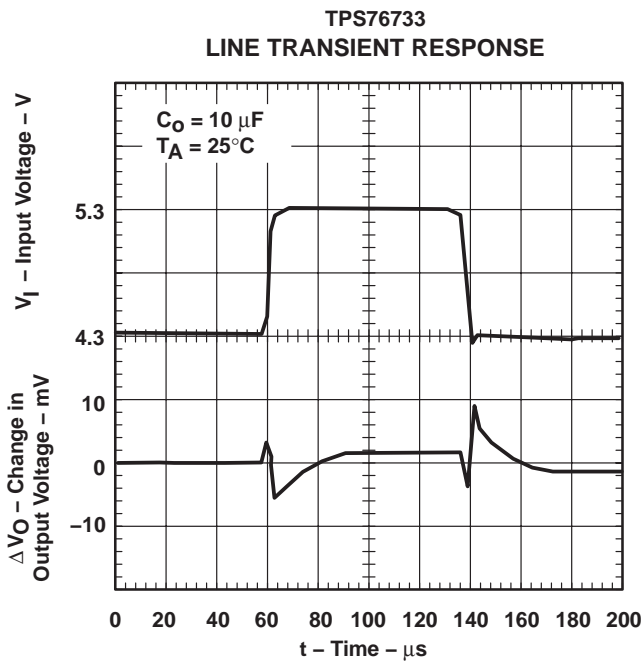

**Figure 17**

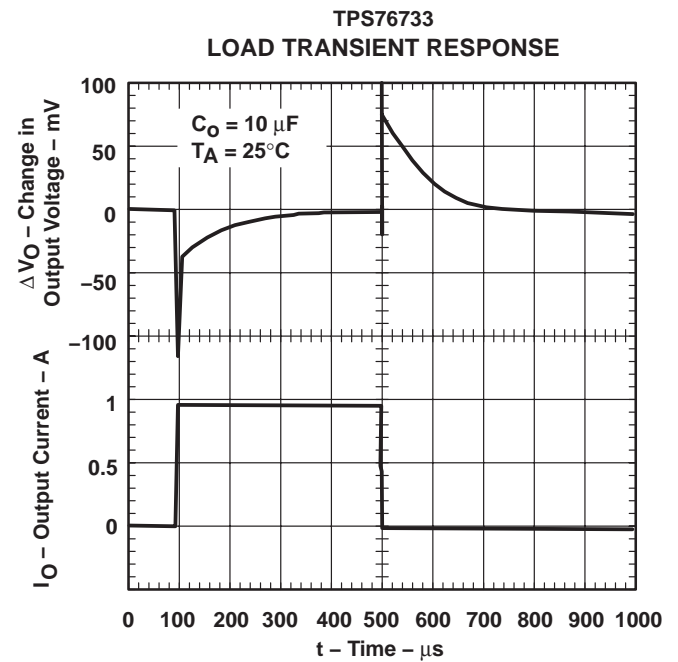

**Figure 18**

TYPICAL CHARACTERISTICS

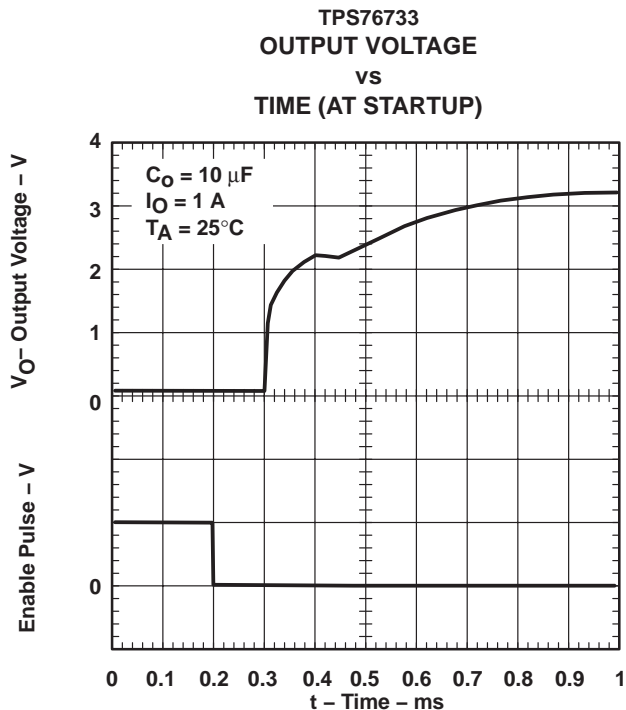

Figure 19

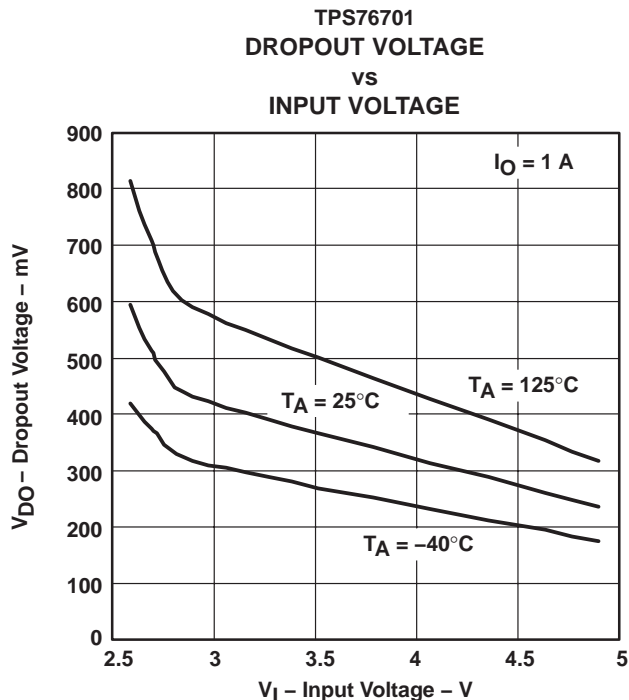

Figure 20

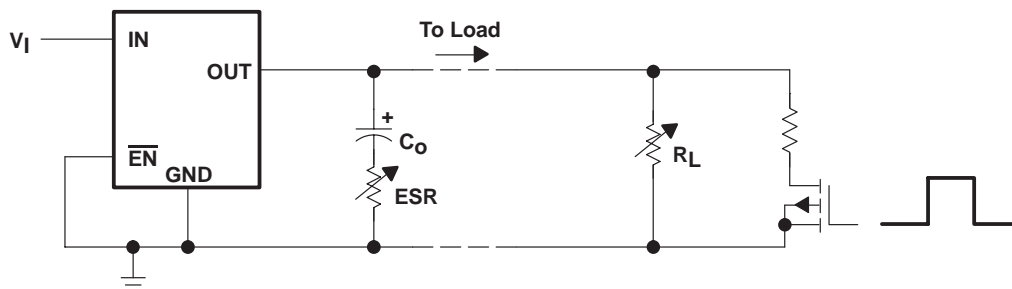

Figure 21. Test Circuit for Typical Regions of Stability (Figures 22 Through 25) (Fixed-Output Options)

TYPICAL CHARACTERISTICS

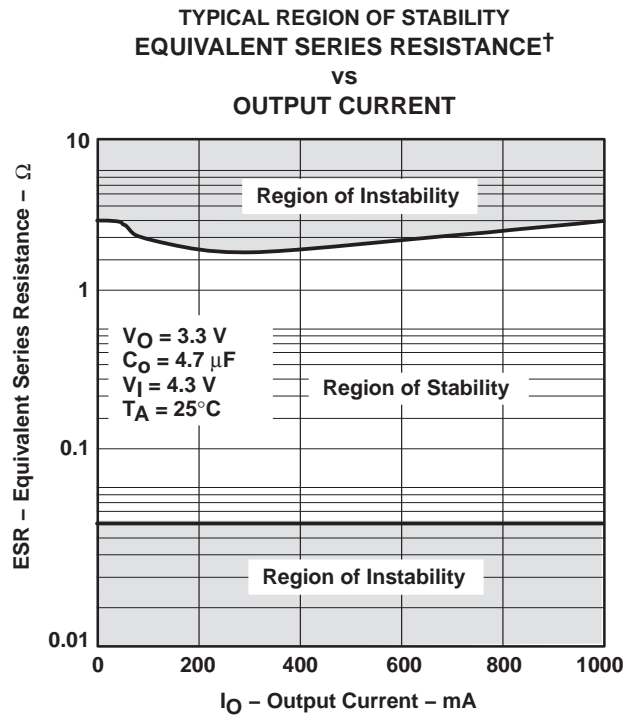

Figure 22

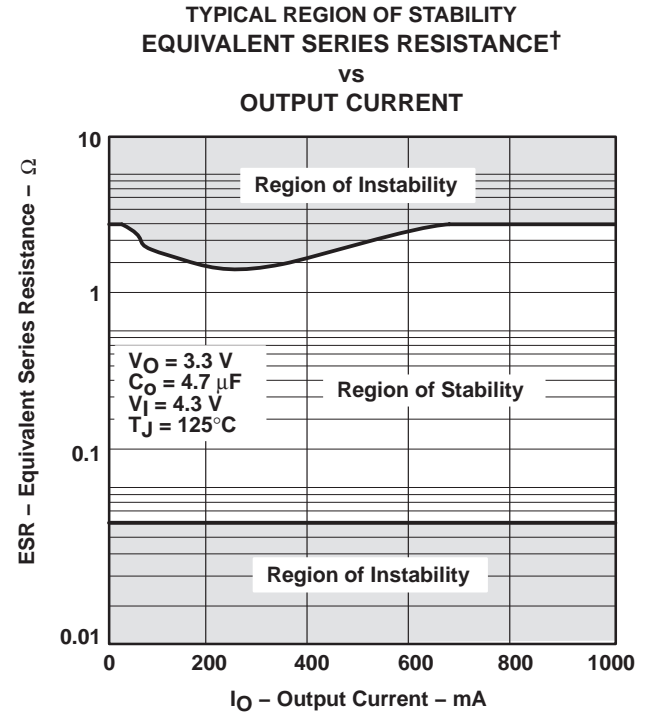

Figure 23

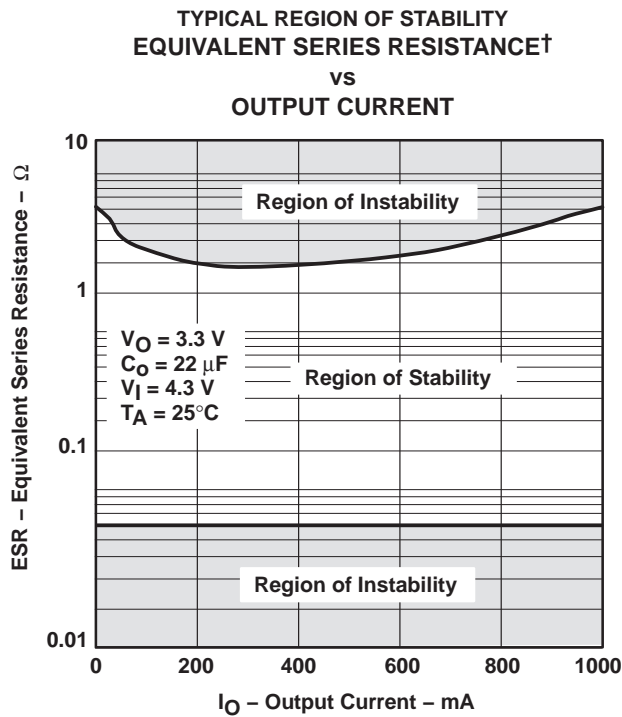

Figure 24

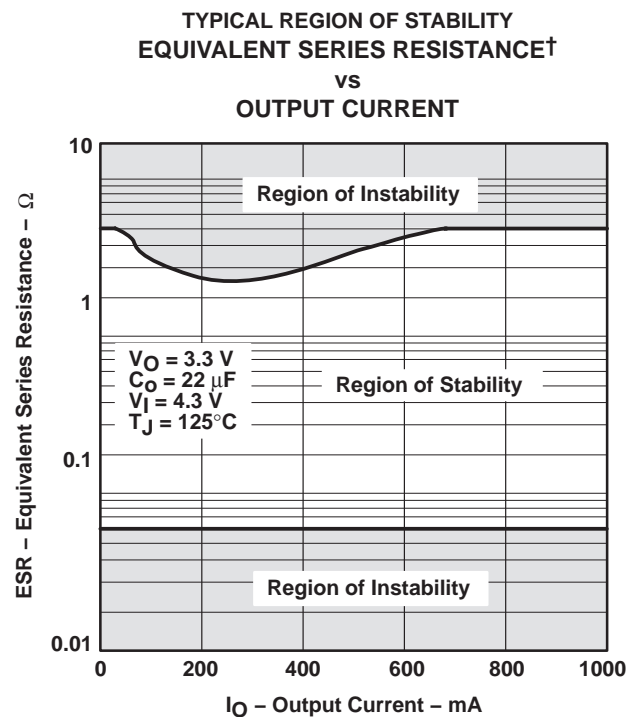

Figure 25

† Equivalent series resistance (ESR) refers to the total series resistance, including the ESR of the capacitor, any series resistance added externally, and PWB trace resistance to  $C_O$ .

# TPS76715-Q1, TPS76718-Q1, TPS76725-Q1, TPS76727-Q1 TPS76728-Q1, TPS76730-Q1, TPS76733-Q1, TPS76750-Q1, TPS76701-Q1 FAST-TRANSIENT-RESPONSE 1-A LOW-DROPOUT VOLTAGE REGULATORS

SGLS009A – MARCH 2003 – REVISED AUGUST 2007

---

## APPLICATION INFORMATION

The TPS767xx family includes eight fixed-output voltage regulators (1.5 V, 1.8 V, 2.5 V, 2.7 V, 2.8 V, 3 V, 3.3 V, and 5 V), and an adjustable regulator, the TPS76701 (adjustable from 1.5 V to 5.5 V).

### device operation

The TPS767xx features very low quiescent current, which remains virtually constant even with varying loads. Conventional LDO regulators use a pnp pass element, the base current of which is directly proportional to the load current through the regulator ( $I_B = I_C/\beta$ ). The TPS767xx uses a PMOS transistor to pass current; because the gate of the PMOS is voltage driven, operating current is low and invariable over the full load range.

Another pitfall associated with the pnp-pass element is its tendency to saturate when the device goes into dropout. The resulting drop in  $\beta$  forces an increase in  $I_B$  to maintain the load. During power up, this translates to large start-up currents. Systems with limited supply current may fail to start up. In battery-powered systems, it means rapid battery discharge when the voltage decays below the minimum required for regulation. The TPS767xx quiescent current remains low even when the regulator drops out, eliminating both problems.

The TPS767xx family also features a shutdown mode that places the output in the high-impedance state (essentially equal to the feedback-divider resistance) and reduces quiescent current to 2  $\mu$ A. If the shutdown feature is not used,  $\overline{EN}$  should be tied to ground.

### minimum load requirements

The TPS767xx family is stable even at zero load; no minimum load is required for operation.

### FB—pin connection (adjustable version only)

The FB pin is an input pin to sense the output voltage and close the loop for the adjustable option. The output voltage is sensed through a resistor divider network to close the loop as shown in Figure 27. Normally, this connection should be as short as possible; however, the connection can be made near a critical circuit to improve performance at that point. Internally, FB connects to a high-impedance wide-bandwidth amplifier and noise pickup feeds through to the regulator output. Routing the FB connection to minimize/avoid noise pickup is essential.

### external capacitor requirements

An input capacitor is not usually required; however, a ceramic bypass capacitor (0.047  $\mu$ F or larger) improves load transient response and noise rejection if the TPS767xx is located more than a few inches from the power supply. A higher-capacitance electrolytic capacitor may be necessary if large (hundreds of milliamps) load transients with fast rise times are anticipated.

Like all low dropout regulators, the TPS767xx requires an output capacitor connected between OUT and GND to stabilize the internal control loop. The minimum recommended capacitance value is 10  $\mu$ F and the equivalent series resistance (ESR) must be between 50 m $\Omega$  and 1.5  $\Omega$ . Capacitor values 10  $\mu$ F or larger are acceptable, provided the ESR is less than 1.5  $\Omega$ . Solid tantalum electrolytic, aluminum electrolytic, and multilayer ceramic capacitors are all suitable, provided they meet the requirements described above. Most of the commercially available 10- $\mu$ F surface-mount ceramic capacitors, including devices from Sprague and Kemet, meet the ESR requirements stated above.



POST OFFICE BOX 655303 • DALLAS, TEXAS 75265



**APPLICATION INFORMATION**

**external capacitor requirements (continued)**

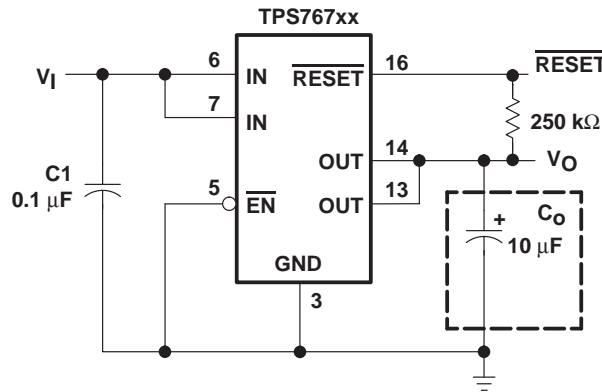

**Figure 26. Typical Application Circuit (Fixed Versions)**

**programming the TPS76701 adjustable LDO regulator**

The output voltage of the TPS76701 adjustable regulator is programmed using an external resistor divider as shown in Figure 27. The output voltage is calculated using:

$$V_O = V_{ref} \times \left( 1 + \frac{R1}{R2} \right) \tag{1}$$

Where:

$$V_{ref} = 1.1834 \text{ V typ (the internal reference voltage)}$$

Resistors R1 and R2 should be chosen for approximately 50-μA divider current. Lower value resistors can be used but offer no inherent advantage and waste more power. Higher values should be avoided as leakage currents at FB increase the output voltage error. The recommended design procedure is to choose R2 = 30.1 kΩ to set the divider current at 50 μA and then calculate R1 using:

$$R1 = \left( \frac{V_O}{V_{ref}} - 1 \right) \times R2 \tag{2}$$

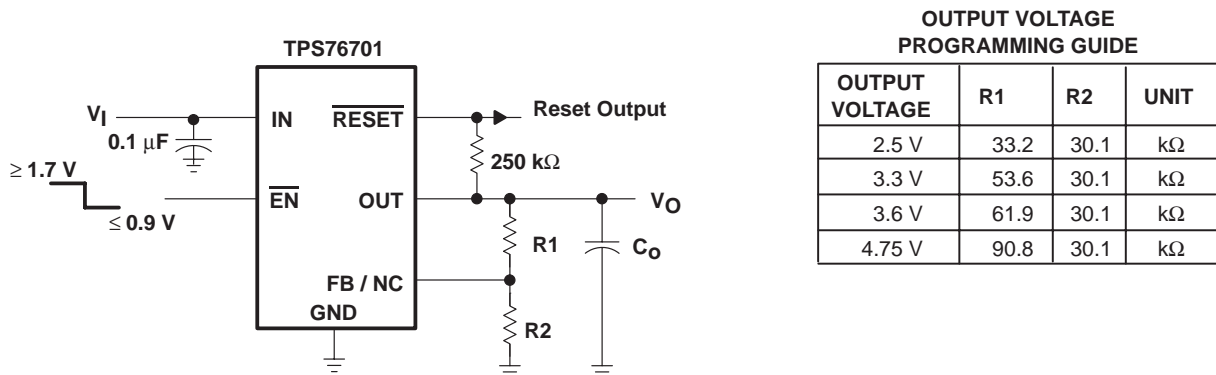

**Figure 27. TPS76701 Adjustable LDO Regulator Programming**

# TPS76715-Q1, TPS76718-Q1, TPS76725-Q1, TPS76727-Q1 TPS76728-Q1, TPS76730-Q1, TPS76733-Q1, TPS76750-Q1, TPS76701-Q1 FAST-TRANSIENT-RESPONSE 1-A LOW-DROPOUT VOLTAGE REGULATORS

SGLS009A – MARCH 2003 – REVISED AUGUST 2007

## APPLICATION INFORMATION

### reset indicator

The TPS767xx features a  $\overline{\text{RESET}}$  output that can be used to monitor the status of the regulator. The internal comparator monitors the output voltage: when the output drops to between 92% and 98% of its nominal regulated value, the  $\overline{\text{RESET}}$  output transistor turns on, taking the signal low. The open-drain output requires a pullup resistor. If not used, it can be left floating.  $\overline{\text{RESET}}$  can be used to drive power-on reset circuitry or as a low-battery indicator.  $\overline{\text{RESET}}$  does not assert itself when the regulated output voltage falls outside the specified 2% tolerance, but instead reports an output voltage low relative to its nominal regulated value (refer to timing diagram for start-up sequence).

### regulator protection

The TPS767xx PMOS pass transistor has a built-in back diode that conducts reverse currents when the input voltage drops below the output voltage (e.g., during power down). Current is conducted from the output to the input and is not internally limited. When extended reverse voltage is anticipated, external limiting may be appropriate.

The TPS767xx also features internal current limiting and thermal protection. During normal operation, the TPS767xx limits output current to approximately 1.7 A. When current limiting engages, the output voltage scales back linearly until the overcurrent condition ends. While current limiting is designed to prevent gross device failure, care should be taken not to exceed the power dissipation ratings of the package. If the temperature of the device exceeds 150°C (typ), thermal-protection circuitry shuts it down. Once the device has cooled below 130°C (typ), regulator operation resumes.

### power dissipation and junction temperature

Specified regulator operation is assured to a junction temperature of 125°C; the maximum junction temperature should be restricted to 125°C under normal operating conditions. This restriction limits the power dissipation the regulator can handle in any given application. To ensure the junction temperature is within acceptable limits, calculate the maximum allowable dissipation,  $P_{D(\text{max})}$ , and the actual dissipation,  $P_D$ , which must be less than or equal to  $P_{D(\text{max})}$ .

The maximum power dissipation limit is determined using the following equation:

$$P_{D(\text{max})} = \frac{T_{J\text{max}} - T_A}{R_{\theta\text{JA}}}$$

Where:

$T_{J\text{max}}$  is the maximum allowable junction temperature.

$R_{\theta\text{JA}}$  is the thermal resistance junction-to-ambient for the package, i.e., 172°C/W for the 8-terminal SOIC and 32.6°C/W for the 20-terminal PWP with no airflow.

$T_A$  is the ambient temperature.

The regulator dissipation is calculated using:

$$P_D = (V_I - V_O) \times I_O$$

Power dissipation resulting from quiescent current is negligible. Excessive power dissipation triggers the thermal protection circuit.



**PACKAGING INFORMATION**

Orderable Device	Status <sup>(1)</sup>	Package Type	Package Drawing	Pins	Package Qty	Eco Plan <sup>(2)</sup>	Lead/Ball Finish	MSL Peak Temp <sup>(3)</sup>
TPS76701QPWPRQ1	ACTIVE	HTSSOP	PWP	20	2000	TBD	CU NIPDAU	Level-1-220C-UNLIM
TPS76715QPWPRQ1	ACTIVE	HTSSOP	PWP	20	2000	TBD	CU NIPDAU	Level-1-220C-UNLIM
TPS76718QPWPRQ1	ACTIVE	HTSSOP	PWP	20	2000	TBD	CU NIPDAU	Level-1-220C-UNLIM
TPS76725QPWPRQ1	ACTIVE	HTSSOP	PWP	20	2000	TBD	CU NIPDAU	Level-1-220C-UNLIM
TPS76733QPWPRQ1	ACTIVE	HTSSOP	PWP	20	2000	TBD	CU NIPDAU	Level-1-220C-UNLIM
TPS76750QPWPRQ1	ACTIVE	HTSSOP	PWP	20	2000	TBD	CU NIPDAU	Level-1-220C-UNLIM

<sup>(1)</sup> The marketing status values are defined as follows:

**ACTIVE:** Product device recommended for new designs.

**LIFEBUY:** TI has announced that the device will be discontinued, and a lifetime-buy period is in effect.

**NRND:** Not recommended for new designs. Device is in production to support existing customers, but TI does not recommend using this part in a new design.

**PREVIEW:** Device has been announced but is not in production. Samples may or may not be available.

**OBsolete:** TI has discontinued the production of the device.

<sup>(2)</sup> Eco Plan - The planned eco-friendly classification: Pb-Free (RoHS), Pb-Free (RoHS Exempt), or Green (RoHS & no Sb/Br) - please check <http://www.ti.com/productcontent> for the latest availability information and additional product content details.

**TBD:** The Pb-Free/Green conversion plan has not been defined.

**Pb-Free (RoHS):** TI's terms "Lead-Free" or "Pb-Free" mean semiconductor products that are compatible with the current RoHS requirements for all 6 substances, including the requirement that lead not exceed 0.1% by weight in homogeneous materials. Where designed to be soldered at high temperatures, TI Pb-Free products are suitable for use in specified lead-free processes.

**Pb-Free (RoHS Exempt):** This component has a RoHS exemption for either 1) lead-based flip-chip solder bumps used between the die and package, or 2) lead-based die adhesive used between the die and leadframe. The component is otherwise considered Pb-Free (RoHS compatible) as defined above.

**Green (RoHS & no Sb/Br):** TI defines "Green" to mean Pb-Free (RoHS compatible), and free of Bromine (Br) and Antimony (Sb) based flame retardants (Br or Sb do not exceed 0.1% by weight in homogeneous material)

<sup>(3)</sup> MSL, Peak Temp. -- The Moisture Sensitivity Level rating according to the JEDEC industry standard classifications, and peak solder temperature.

**Important Information and Disclaimer:**The information provided on this page represents TI's knowledge and belief as of the date that it is provided. TI bases its knowledge and belief on information provided by third parties, and makes no representation or warranty as to the accuracy of such information. Efforts are underway to better integrate information from third parties. TI has taken and continues to take reasonable steps to provide representative and accurate information but may not have conducted destructive testing or chemical analysis on incoming materials and chemicals. TI and TI suppliers consider certain information to be proprietary, and thus CAS numbers and other limited information may not be available for release.

In no event shall TI's liability arising out of such information exceed the total purchase price of the TI part(s) at issue in this document sold by TI to Customer on an annual basis.

PWP (R-PDSO-G\*\*) 20 PIN SHOWN

PowerPAD™ PLASTIC SMALL-OUTLINE PACKAGE

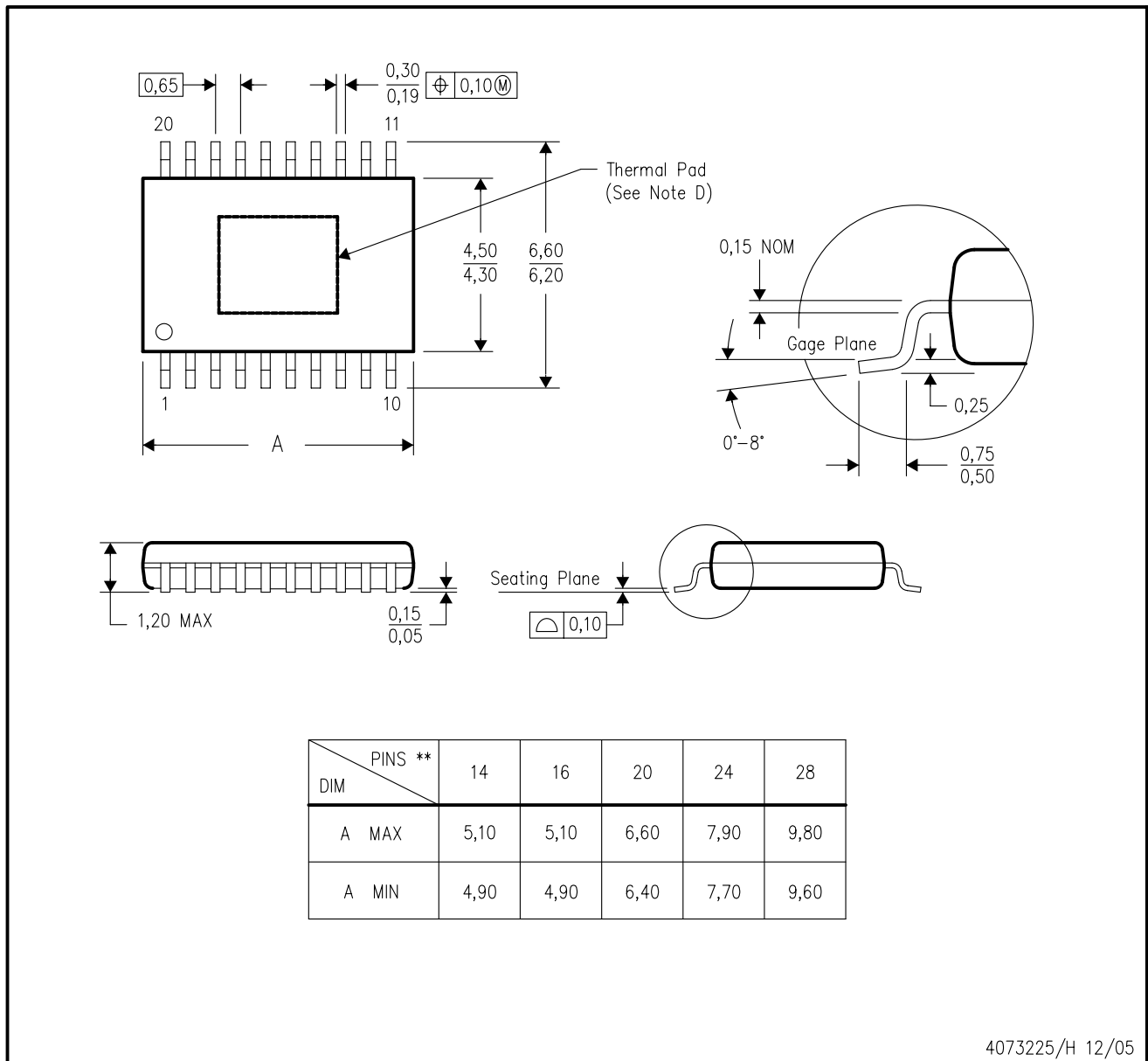

4073225/H 12/05

- NOTES:
- A. All linear dimensions are in millimeters.
  - B. This drawing is subject to change without notice.
  - C. Body dimensions do not include mold flash or protrusions. Mold flash and protrusion shall not exceed 0.15 per side.
  - D. This package is designed to be soldered to a thermal pad on the board. Refer to Technical Brief, PowerPad Thermally Enhanced Package, Texas Instruments Literature No. SLMA002 for information regarding recommended board layout. This document is available at [www.ti.com](http://www.ti.com) <<http://www.ti.com>>.
  - E. Falls within JEDEC MO-153

PowerPAD is a trademark of Texas Instruments.

THERMAL INFORMATION

This PowerPAD™ package incorporates an exposed thermal pad that is designed to be attached directly to an external heatsink. The thermal pad must be soldered directly to the printed circuit board (PCB). After soldering, the PCB can be used as a heatsink. In addition, through the use of thermal vias, the thermal pad can be attached directly to the appropriate copper plane shown in the electrical schematic for the device, or alternatively, can be attached to a special heatsink structure designed into the PCB. This design optimizes the heat transfer from the integrated circuit (IC).

For additional information on the PowerPAD package and how to take advantage of its heat dissipating abilities, refer to Technical Brief, PowerPAD Thermally Enhanced Package, Texas Instruments Literature No. SLMA002 and Application Brief, PowerPAD Made Easy, Texas Instruments Literature No. SLMA004. Both documents are available at [www.ti.com](http://www.ti.com).

The exposed thermal pad dimensions for this package are shown in the following illustration.

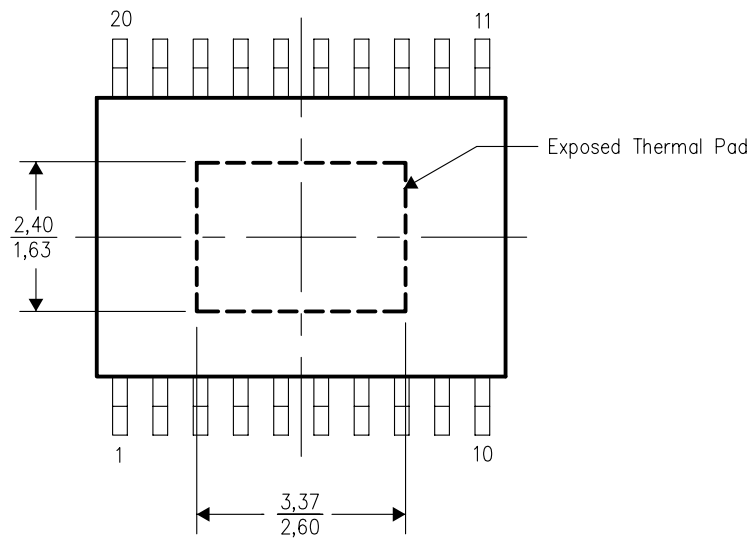

Top View

NOTE: All linear dimensions are in millimeters

Exposed Thermal Pad Dimensions

PWP (R-PDSO-G20) PowerPAD™

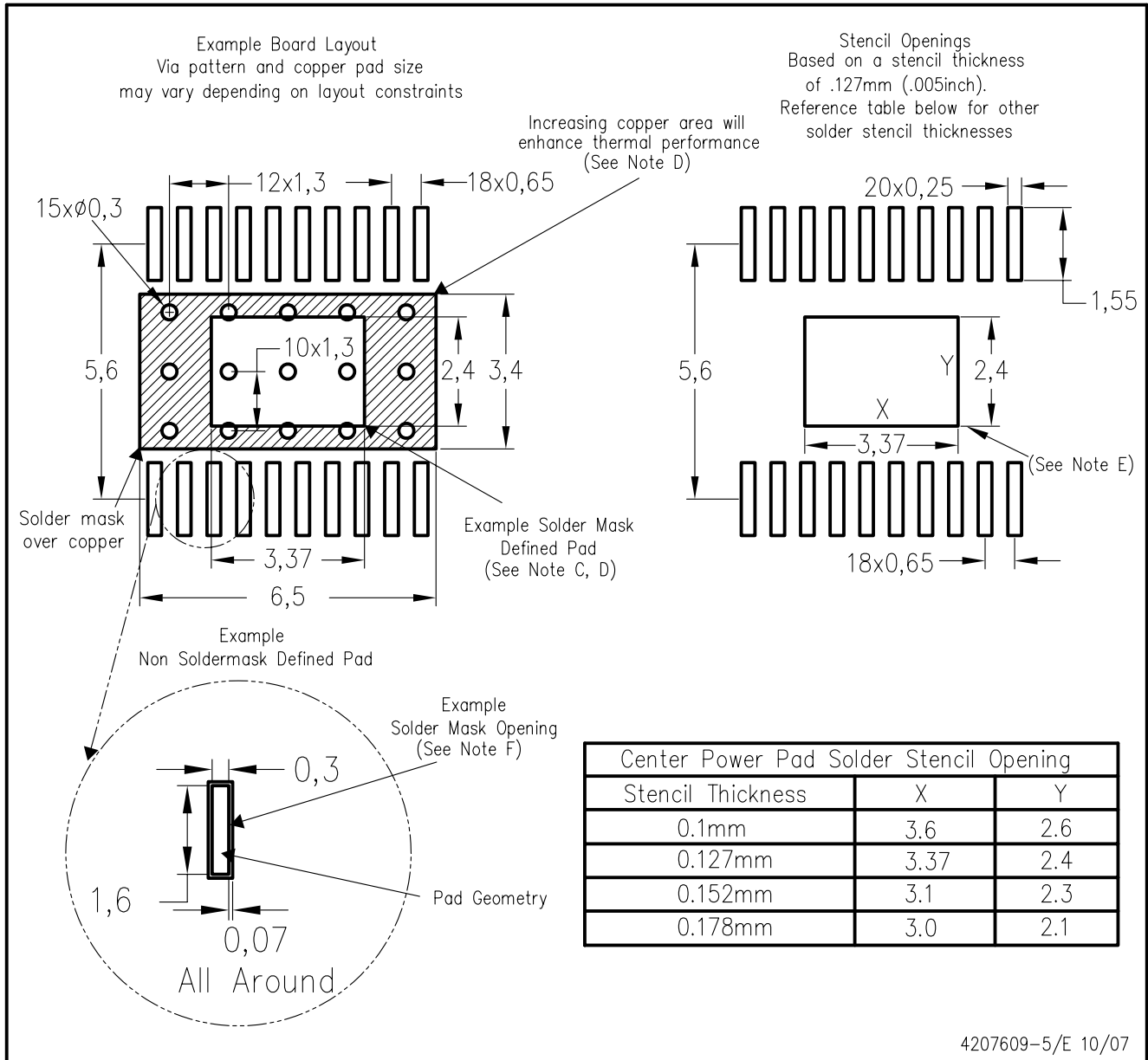

- NOTES:
- A. All linear dimensions are in millimeters.
  - B. This drawing is subject to change without notice.
  - C. Customers should place a note on the circuit board fabrication drawing not to alter the center solder mask defined pad.
  - D. This package is designed to be soldered to a thermal pad on the board. Refer to Technical Brief, PowerPad Thermally Enhanced Package, Texas Instruments Literature No. SLMA002, SLMA004, and also the Product Data Sheets for specific thermal information, via requirements, and recommended board layout. These documents are available at [www.ti.com](http://www.ti.com) <<http://www.ti.com>>. Publication IPC-7351 is recommended for alternate designs.
  - E. Laser cutting apertures with trapezoidal walls and also rounding corners will offer better paste release. Customers should contact their board assembly site for stencil design recommendations. Example stencil design based on a 50% volumetric metal load solder paste. Refer to IPC-7525 for other stencil recommendations.
  - F. Customers should contact their board fabrication site for solder mask tolerances between and around signal pads.

PowerPAD is a trademark of Texas Instruments.

## IMPORTANT NOTICE

Texas Instruments Incorporated and its subsidiaries (TI) reserve the right to make corrections, modifications, enhancements, improvements, and other changes to its products and services at any time and to discontinue any product or service without notice. Customers should obtain the latest relevant information before placing orders and should verify that such information is current and complete. All products are sold subject to TI's terms and conditions of sale supplied at the time of order acknowledgment.

TI warrants performance of its hardware products to the specifications applicable at the time of sale in accordance with TI's standard warranty. Testing and other quality control techniques are used to the extent TI deems necessary to support this warranty. Except where mandated by government requirements, testing of all parameters of each product is not necessarily performed.

TI assumes no liability for applications assistance or customer product design. Customers are responsible for their products and applications using TI components. To minimize the risks associated with customer products and applications, customers should provide adequate design and operating safeguards.

TI does not warrant or represent that any license, either express or implied, is granted under any TI patent right, copyright, mask work right, or other TI intellectual property right relating to any combination, machine, or process in which TI products or services are used. Information published by TI regarding third-party products or services does not constitute a license from TI to use such products or services or a warranty or endorsement thereof. Use of such information may require a license from a third party under the patents or other intellectual property of the third party, or a license from TI under the patents or other intellectual property of TI.

Reproduction of TI information in TI data books or data sheets is permissible only if reproduction is without alteration and is accompanied by all associated warranties, conditions, limitations, and notices. Reproduction of this information with alteration is an unfair and deceptive business practice. TI is not responsible or liable for such altered documentation. Information of third parties may be subject to additional restrictions.

Resale of TI products or services with statements different from or beyond the parameters stated by TI for that product or service voids all express and any implied warranties for the associated TI product or service and is an unfair and deceptive business practice. TI is not responsible or liable for any such statements.

TI products are not authorized for use in safety-critical applications (such as life support) where a failure of the TI product would reasonably be expected to cause severe personal injury or death, unless officers of the parties have executed an agreement specifically governing such use. Buyers represent that they have all necessary expertise in the safety and regulatory ramifications of their applications, and acknowledge and agree that they are solely responsible for all legal, regulatory and safety-related requirements concerning their products and any use of TI products in such safety-critical applications, notwithstanding any applications-related information or support that may be provided by TI. Further, Buyers must fully indemnify TI and its representatives against any damages arising out of the use of TI products in such safety-critical applications.

TI products are neither designed nor intended for use in military/aerospace applications or environments unless the TI products are specifically designated by TI as military-grade or "enhanced plastic." Only products designated by TI as military-grade meet military specifications. Buyers acknowledge and agree that any such use of TI products which TI has not designated as military-grade is solely at the Buyer's risk, and that they are solely responsible for compliance with all legal and regulatory requirements in connection with such use.

TI products are neither designed nor intended for use in automotive applications or environments unless the specific TI products are designated by TI as compliant with ISO/TS 16949 requirements. Buyers acknowledge and agree that, if they use any non-designated products in automotive applications, TI will not be responsible for any failure to meet such requirements.

Following are URLs where you can obtain information on other Texas Instruments products and application solutions:

<b>Products</b>		<b>Applications</b>	
Amplifiers	<a href="http://amplifier.ti.com">amplifier.ti.com</a>	Audio	<a href="http://www.ti.com/audio">www.ti.com/audio</a>
Data Converters	<a href="http://dataconverter.ti.com">dataconverter.ti.com</a>	Automotive	<a href="http://www.ti.com/automotive">www.ti.com/automotive</a>
DSP	<a href="http://dsp.ti.com">dsp.ti.com</a>	Broadband	<a href="http://www.ti.com/broadband">www.ti.com/broadband</a>
Interface	<a href="http://interface.ti.com">interface.ti.com</a>	Digital Control	<a href="http://www.ti.com/digitalcontrol">www.ti.com/digitalcontrol</a>
Logic	<a href="http://logic.ti.com">logic.ti.com</a>	Military	<a href="http://www.ti.com/military">www.ti.com/military</a>
Power Mgmt	<a href="http://power.ti.com">power.ti.com</a>	Optical Networking	<a href="http://www.ti.com/opticalnetwork">www.ti.com/opticalnetwork</a>
Microcontrollers	<a href="http://microcontroller.ti.com">microcontroller.ti.com</a>	Security	<a href="http://www.ti.com/security">www.ti.com/security</a>
RFID	<a href="http://www.ti-rfid.com">www.ti-rfid.com</a>	Telephony	<a href="http://www.ti.com/telephony">www.ti.com/telephony</a>
Low Power Wireless	<a href="http://www.ti.com/lpw">www.ti.com/lpw</a>	Video & Imaging	<a href="http://www.ti.com/video">www.ti.com/video</a>
		Wireless	<a href="http://www.ti.com/wireless">www.ti.com/wireless</a>

Mailing Address: Texas Instruments, Post Office Box 655303, Dallas, Texas 75265  
Copyright © 2007, Texas Instruments Incorporated