

SHINDENGEN

Super Fast Recovery Rectifiers

Single

D4L20U

200V 4A

FEATURES

- Low noise
- trr35ns
- Fully Isolated Molding

APPLICATION

- Switching power supply
- Free Wheel
- Home Appliances, Office Equipment
- Telecommunication, Factory Automation

OUTLINE DIMENSIONS

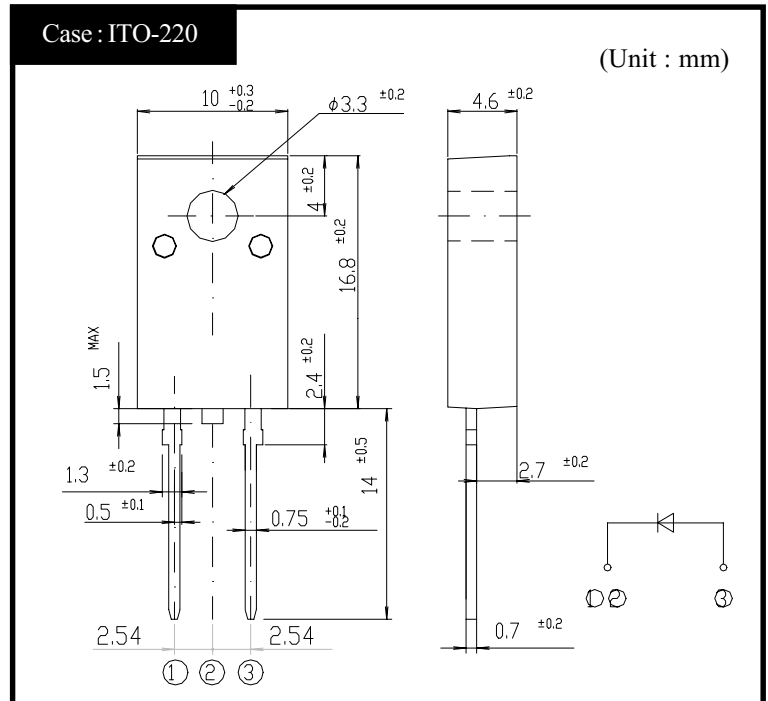

RATINGS

● Absolute Maximum Ratings (If not specified Tc=25°C)

Item	Symbol	Conditions	Ratings	Unit
Storage Temperature	T _{stg}		-40~150	°C
Operating Junction Temperature	T _j		150	°C
Maximum Reverse Voltage	V _{RM}		200	V
Average Rectified Forward Current	I _O	50Hz sine wave, R-load, T _c =130°C	4	A
Peak Surge Forward Current	I _{FSM}	50Hz sine wave, Non-repetitive 1 cycle peak value, T _j =25°C	60	A
Dielectric Strength	V _{dis}	Terminals to case, AC 1 minute	1.5	kV
Mounting Torque	TOR	(Recommended torque: 0.3N·m)	0.5	N·m

● Electrical Characteristics (If not specified Tc=25°C)

Item	Symbol	Conditions	Ratings	Unit
Forward Voltage	V _F	I _F =4A, Pulse measurement	Max 0.98	V
Reverse Current	I _R	V _R =V _{RM} , Pulse measurement	Max 10	μA
Reverse Recovery Time	trr	I _F =0.5A, I _R =1A	Max 35	ns
Thermal Resistance	θ _{jc}	junction to case	Max 4.5	°C/W
	θ _{jf}	junction to heatsink (Reference value)	Max 6.0	

D4L20U

Forward Voltage

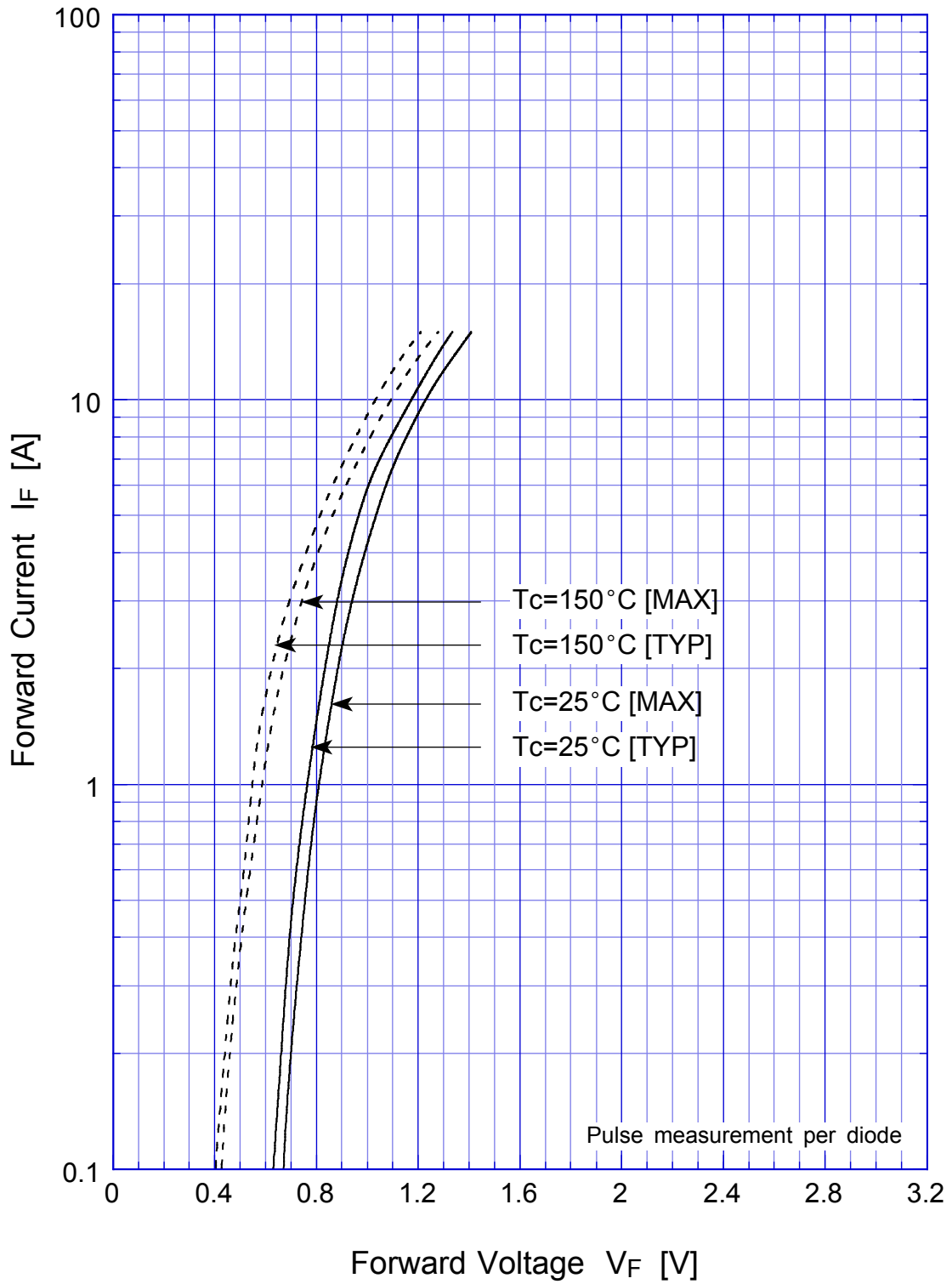

D4L20U

Forward Power Dissipation

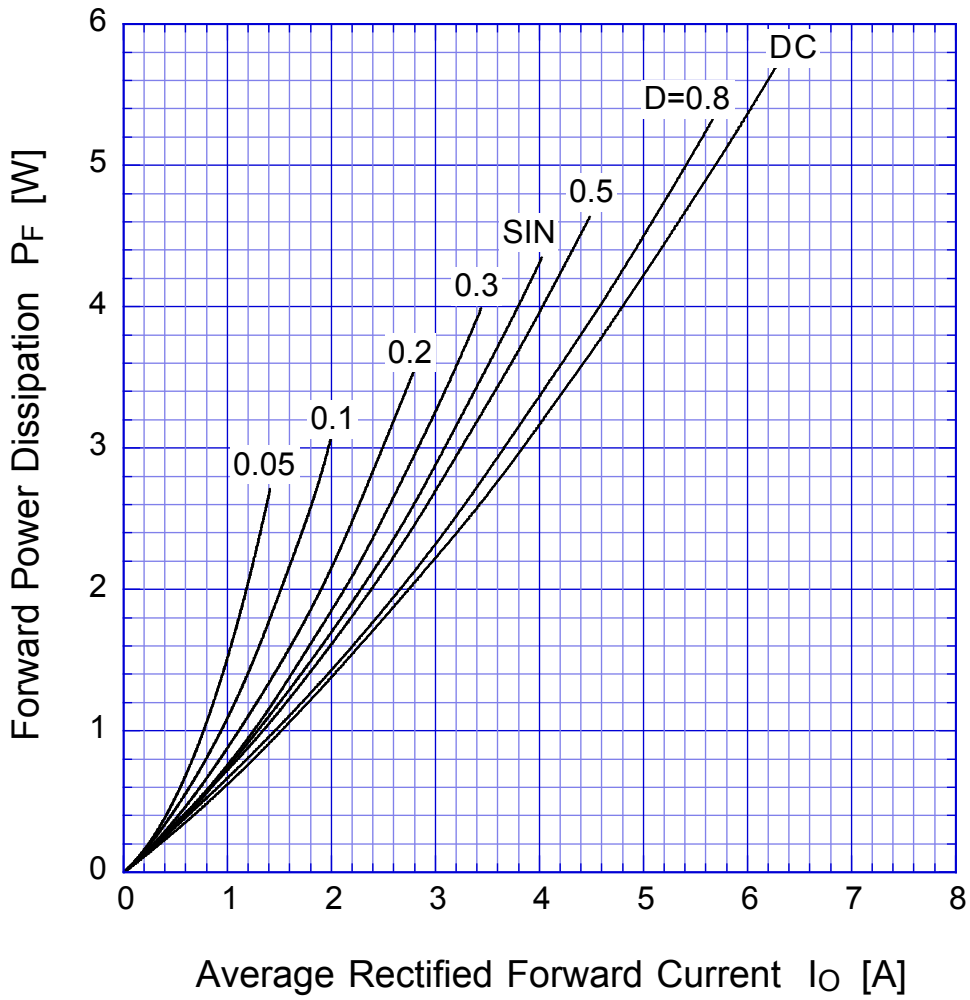

$T_j = T_{jmax}$

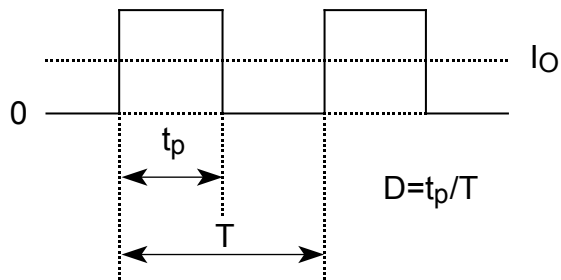

D4L20U

Derating Curve

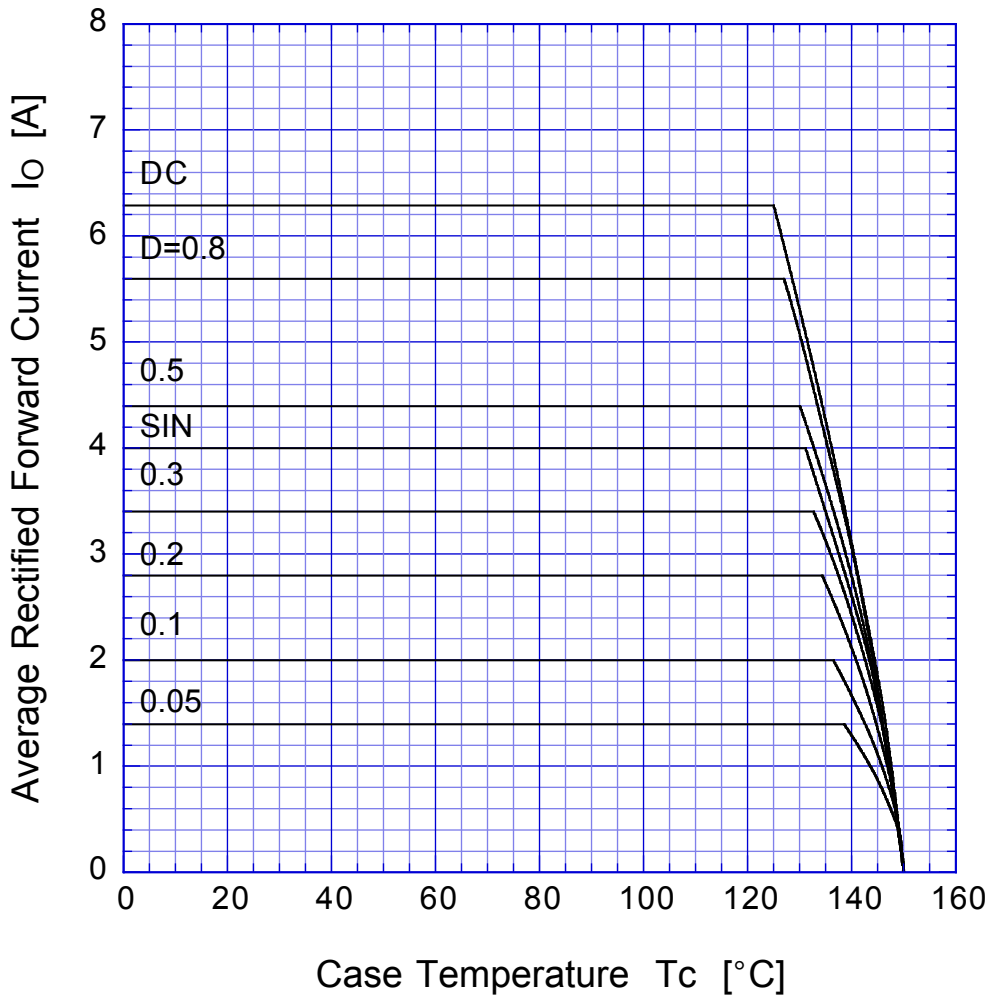

$$V_R = V_{RM}$$



D4L20U

Peak Surge Forward Capability

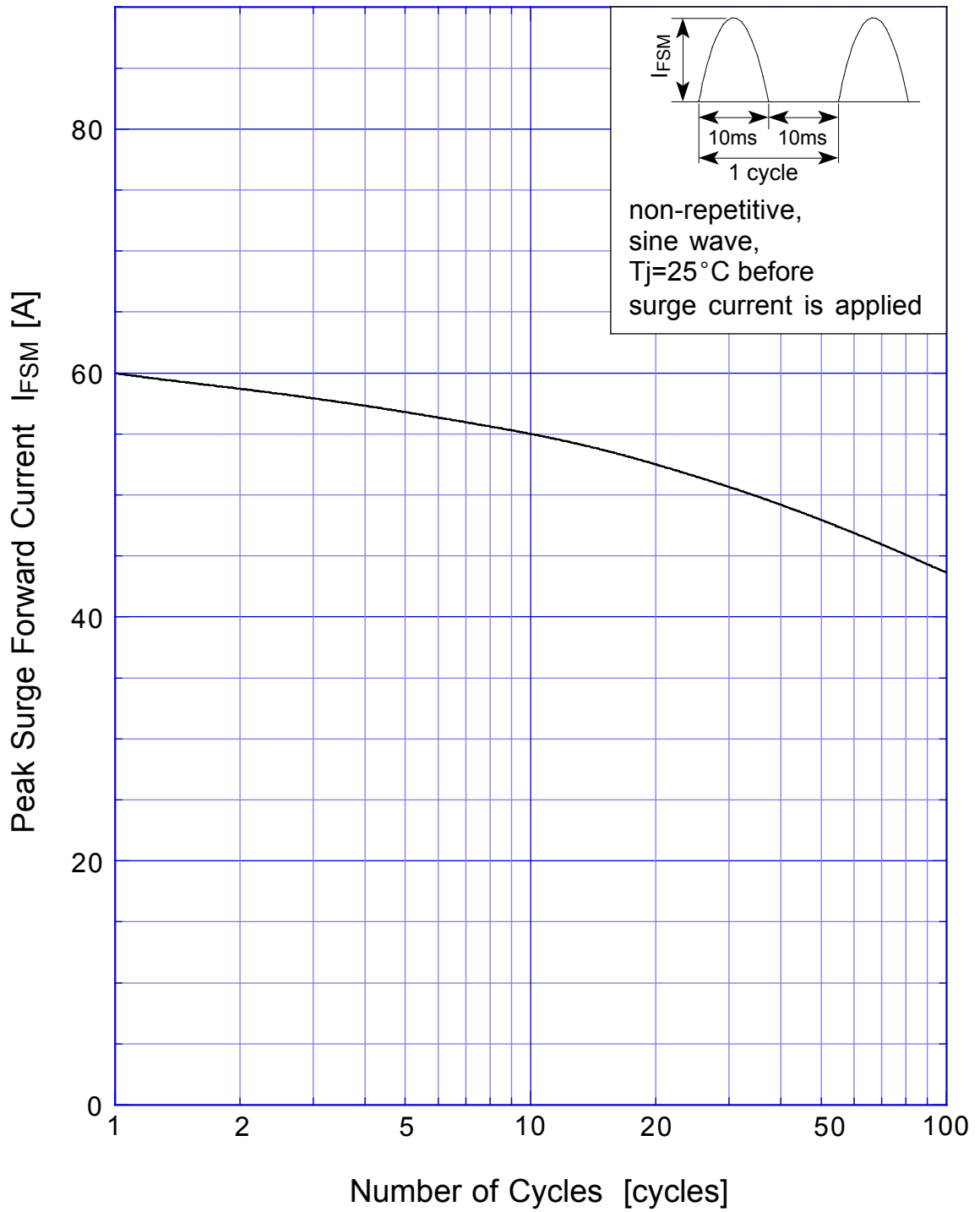

D4L20U Junction Capacitance

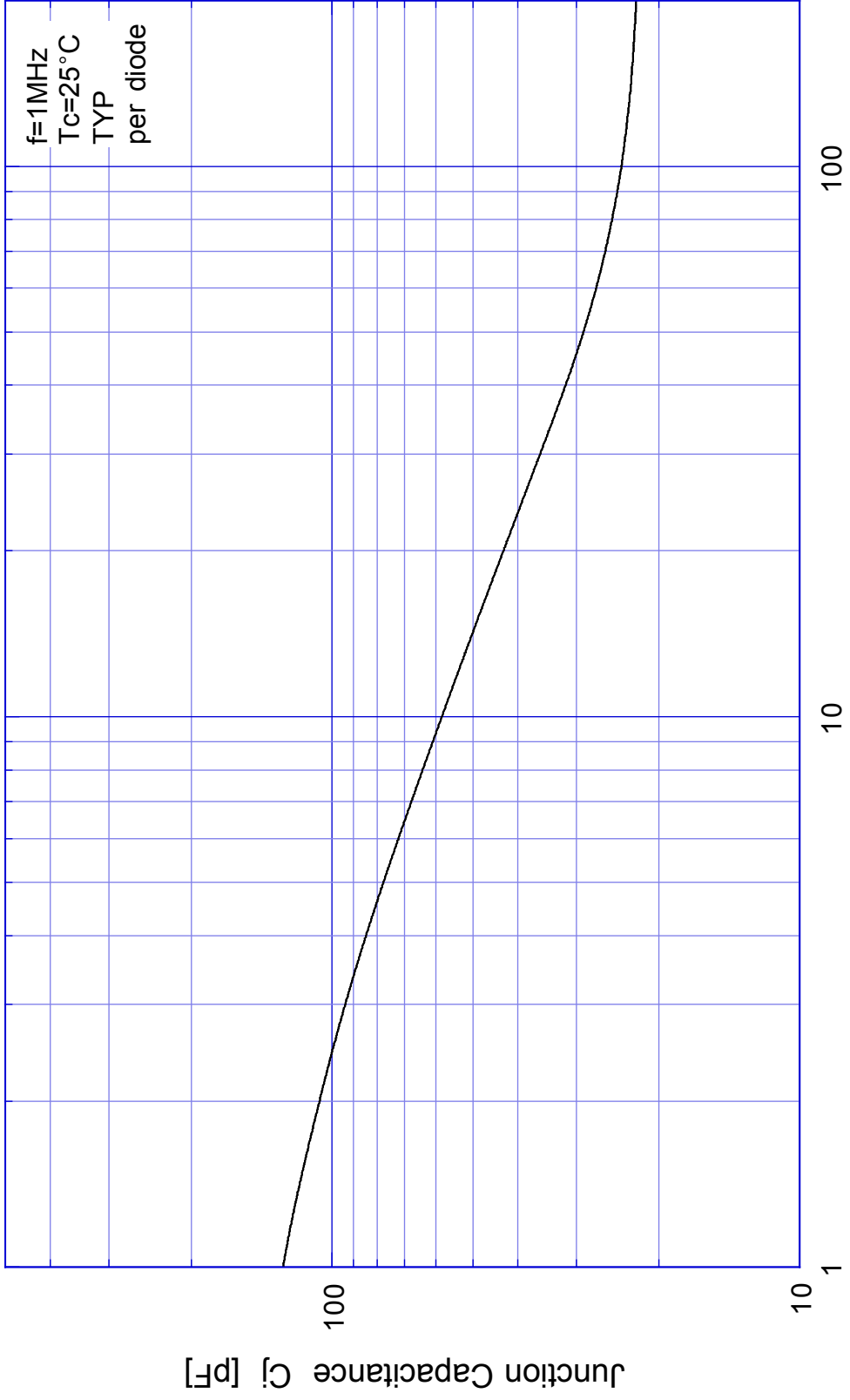

Reverse Voltage V_R [V]

Junction Capacitance C_j [pF]