

DATA SHEET

APD Series: Silicon PIN Diodes, Packaged and Bondable Chips

Applications

- Switches
- Attenuators

Features

- Established Skyworks PIN diode process
- Low capacitance designs to 0.05 pF
- Voltage ratings to 200 V
- Chip size < 15 mils square
- Tight control of I layer base width
- Mesa and planar chip designs



NEW Skyworks Green™ products are RoHS (Restriction of Hazardous Substances)-compliant, conform to the EIA/EICTA/JEITA Joint Industry Guide (JIG) Level A guidelines, are halogen free according to IEC-61249-2-21, and contain <1,000 ppm antimony trioxide in polymeric materials.

Description

Skyworks APD series of silicon PIN diodes are designed for use as switch and attenuator devices in high-performance RF and microwave circuits. The PIN diode designs are useful over a wide range of frequencies from below 100 MHz to beyond 30 GHz. These devices use Skyworks well-established silicon technology resulting in PIN diodes with tightly controlled I-region characteristics.

Devices APD0505-000 through APD0810-000 are designed for fast speed through moderate speed switch applications. They have low resistance and capacitance at zero and reverse bias. The thick I-region APD2220-000 is designed for low-distortion attenuator applications.

The absolute maximum ratings of the APD diode series are provided in Table 1. Electrical specifications are specified in Table 2. Typical performance characteristics are provided in Figures 1 and 2. Table 3 identifies the die part numbers with their corresponding top contact diameters and die outline drawings. Table 4 identifies the hermetic part numbers together with their thermal resistance specifications and hermetic outline drawings.

Table 1. APD Series Absolute Maximum Ratings

Parameter	Symbol	Minimum	Typical	Maximum	Units
Power dissipation	P _{DIS}			$\frac{\text{Maximum } T_J - \text{Case Temp}}{\text{Thermal Resistance}_{\text{junction-to-case}}}$	W
Reverse voltage	V _R			See Voltage Rating column in Table 2	V
Forward current	I _F			200	mA
Operating temperature	T _{OP}	-65		+175	°C
Storage temperature	T _{STG}	-65		+200	°C

Note: Exposure to maximum rating conditions for extended periods may reduce device reliability. There is no damage to device with only one parameter set at the limit and all other parameters set at or below their nominal value. Exceeding any of the limits listed here may result in permanent damage to the device.

CAUTION: Although this device is designed to be as robust as possible, Electrostatic Discharge (ESD) can damage this device. This device must be protected at all times from ESD. Static charges may easily produce potentials of several kilovolts on the human body or equipment, which can discharge without detection. Industry-standard ESD precautions should be used at all times.

Table 2. APD Series Electrical Specifications (Note 1)

(T_{OP} = +25 °C, Unless Otherwise Noted)

Parameter	Junction Capacitance (C _J) V _R = 50 V, 1 MHz (pF)	Junction Capacitance (C _J) V _R = 0 V, 1 MHz (pF)	Series Resistance (R _S), I = 10 mA, 500 MHz (Ω)	Minority Carrier Lifetime (T _L) I = 10 mA (ns)	Voltage Rating (Note 2) (V)	I-Region Thickness (μm)	Thermal Resistance (θ _{JC}) (°C/W)
	Maximum	Typical	Maximum	Typical		Nominal	Maximum
Switching Applications							
APD0505-000	0.05	0.10	2.0	20	50	5	100
APD0510-000	0.10	0.20	1.5	40	50	5	80
APD0520-000	0.20	0.25	1.0	50	50	5	80
APD0805-000	0.05	0.10	2.0	100	100	8	80
APD0810-000	0.10	0.15	1.5	160	100	8	60
APD1510-000	0.10	0.20	2.0	300	200	15	60
APD1520-000	0.20	0.25	1.2	900	200	15	30
Attenuator Applications							
APD2220-000	0.20	0.35	4.0	700	100	50	80

Note 1: Performance is guaranteed only under the conditions listed in this Table.

Note 2: Reverse current is specified at 10 μA maximum at the voltage rating noted. Do not exceed this voltage.

Table 3. APD Series Parts

Part Number	Top Contact Diameter (±0.5 mils)	Die Drawing
Switching Applications		
APD0505-000	1.5	150-806
APD0510-000	2.5	150-801
APD0520-000	3.5	150-801
APD0805-000	2.0	150-801
APD0810-000	3.0	150-801
APD1510-000	3.0	150-813
APD1520-000	4.0	150-802
Attenuator Applications		
APD2220-000	8.5	149-815

Table 4. Hermetic Packages

Hermetic Stripline Drawing	Typical Thermal Resistance (θ _{Jc}) (°C/W)	Hermetic Pill Drawing	Typical Thermal Resistance (θ _{Jc}) (°C/W)	Hermetic Pill Drawing	Typical Thermal Resistance (θ _{Jc}) (°C/W)	Hermetic Pill Drawing	Typical Thermal Resistance (θ _{Jc}) (°C/W)
APD0505-240	190	APD0505-203	130	APD0505-210	120	APD0505-219	190
APD0510-240	180	APD0510-203	110	APD0510-210	100	APD0510-219	180
APD0520-240	180	APD0520-203	110	APD0520-210	100	APD0520-219	180
APD0805-240	180	APD0805-203	110	APD0805-210	100	APD0805-219	180
APD0810-240	160	APD0810-203	90	APD0810-210	80	APD0810-219	160
APD1510-240	160	APD1510-203	90	APD1510-210	80	APD1510-219	160
APD1520-240	130	APD1520-203	60	APD1520-210	50	APD1520-219	130
APD2220-240	110	APD2220-203	100	APD2220-210	100	APD2220-219	110

Typical Performance Characteristics at 25 °C

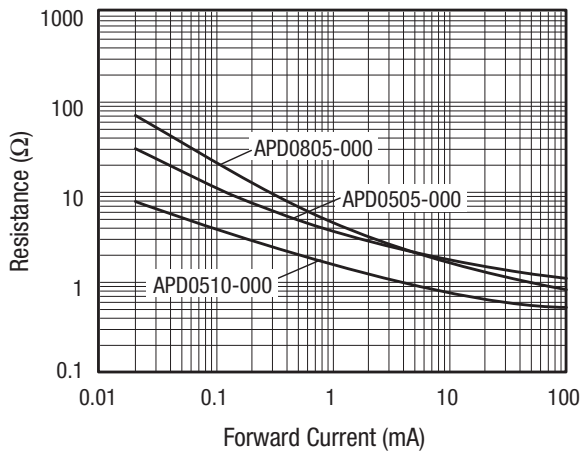

Figure 1. Resistance vs Forward Current @ 1 GHz

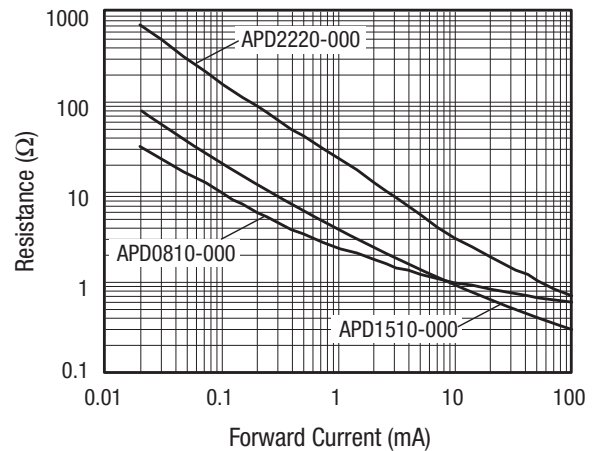

Figure 2. Resistance vs Forward Current @ 1 GHz

Package Outline Drawings

Package outline die drawings for the APD diode series are shown in Figures 3 and 4. Hermetic package outlines are shown in Figures 5 through 8.

Die Packages

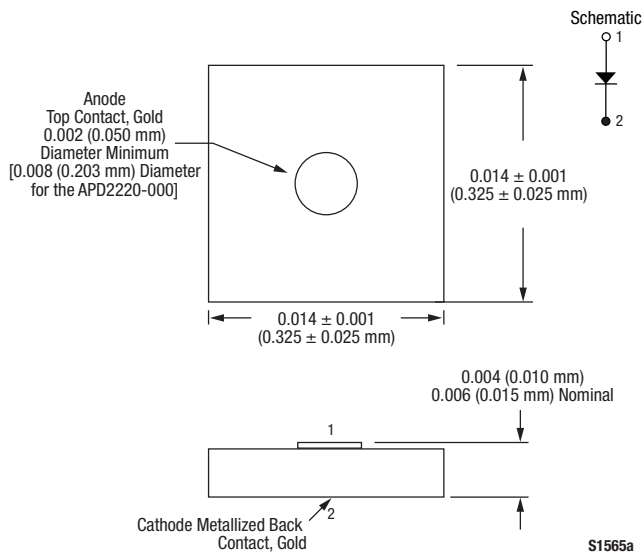

Figure 3. 149-815 Package

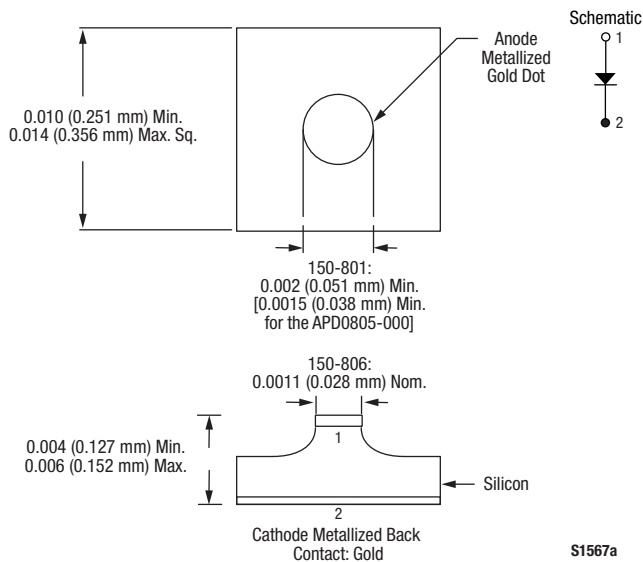

Figure 4. 150 Series Package

Hermetic Packages

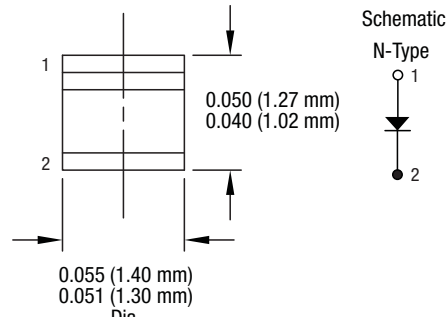

Figure 5. -203 Package

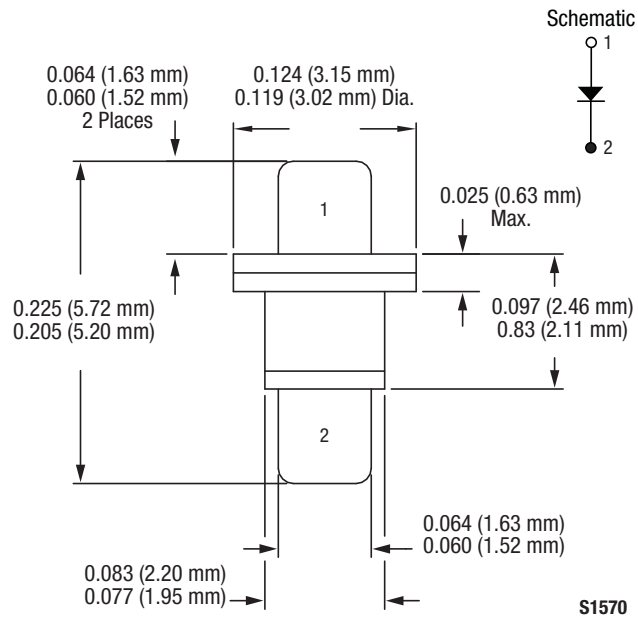

Figure 6. -210 Package

Hermetic Packages (Continued)

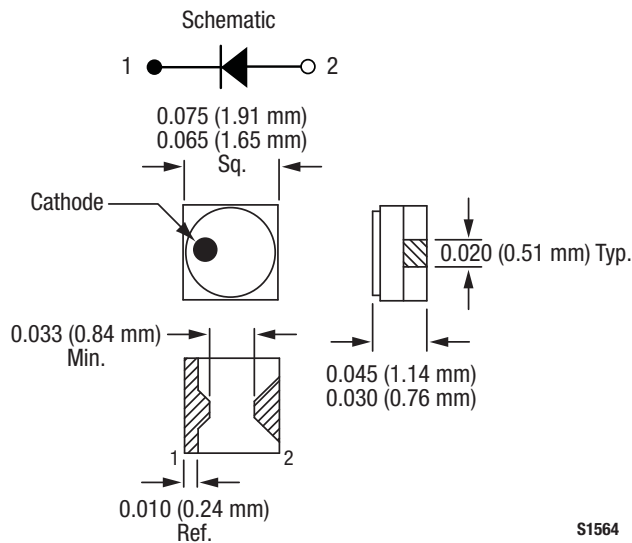

Figure 7. -219 Package

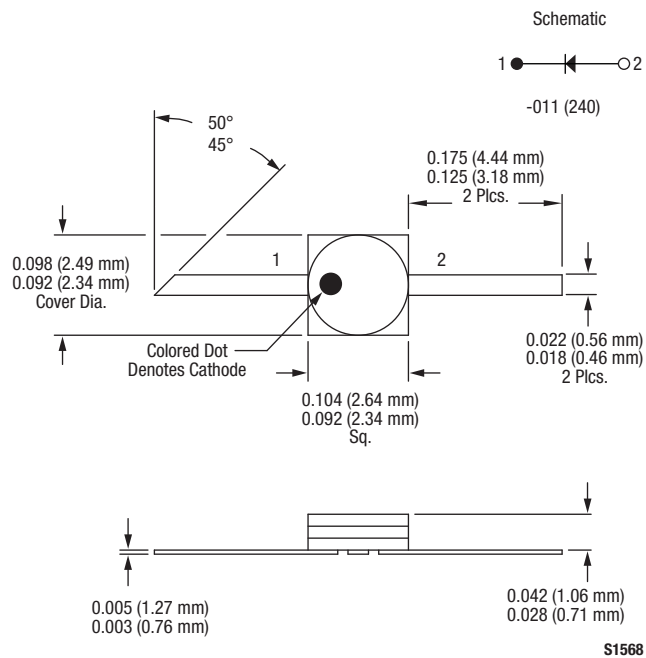

Figure 8. -240 Package

Copyright © 2002-2010 Skyworks Solutions, Inc. All Rights Reserved.

Information in this document is provided in connection with Skyworks Solutions, Inc. ("Skyworks") products or services. These materials, including the information contained herein, are provided by Skyworks as a service to its customers and may be used for informational purposes only by the customer. Skyworks assumes no responsibility for errors or omissions in these materials or the information contained herein. Skyworks may change its documentation, products, services, specifications or product descriptions at any time, without notice. Skyworks makes no commitment to update the materials or information and shall have no responsibility whatsoever for conflicts, incompatibilities, or other difficulties arising from any future changes.

No license, whether express, implied, by estoppel or otherwise, is granted to any intellectual property rights by this document. Skyworks assumes no liability for any materials, products or information provided hereunder, including the sale, distribution, reproduction or use of Skyworks products, information or materials, except as may be provided in Skyworks Terms and Conditions of Sale.

THE MATERIALS, PRODUCTS AND INFORMATION ARE PROVIDED "AS IS" WITHOUT WARRANTY OF ANY KIND, WHETHER EXPRESS, IMPLIED, STATUTORY, OR OTHERWISE, INCLUDING FITNESS FOR A PARTICULAR PURPOSE OR USE, MERCHANTABILITY, PERFORMANCE, QUALITY OR NON-INFRINGEMENT OF ANY INTELLECTUAL PROPERTY RIGHT; ALL SUCH WARRANTIES ARE HEREBY EXPRESSLY DISCLAIMED. SKYWORKS DOES NOT WARRANT THE ACCURACY OR COMPLETENESS OF THE INFORMATION, TEXT, GRAPHICS OR OTHER ITEMS CONTAINED WITHIN THESE MATERIALS. SKYWORKS SHALL NOT BE LIABLE FOR ANY DAMAGES, INCLUDING BUT NOT LIMITED TO ANY SPECIAL, INDIRECT, INCIDENTAL, STATUTORY, OR CONSEQUENTIAL DAMAGES, INCLUDING WITHOUT LIMITATION, LOST REVENUES OR LOST PROFITS THAT MAY RESULT FROM THE USE OF THE MATERIALS OR INFORMATION, WHETHER OR NOT THE RECIPIENT OF MATERIALS HAS BEEN ADVISED OF THE POSSIBILITY OF SUCH DAMAGE.

Skyworks products are not intended for use in medical, lifesaving or life-sustaining applications, or other equipment in which the failure of the Skyworks products could lead to personal injury, death, physical or environmental damage. Skyworks customers using or selling Skyworks products for use in such applications do so at their own risk and agree to fully indemnify Skyworks for any damages resulting from such improper use or sale.

Customers are responsible for their products and applications using Skyworks products, which may deviate from published specifications as a result of design defects, errors, or operation of products outside of published parameters or design specifications. Customers should include design and operating safeguards to minimize these and other risks. Skyworks assumes no liability for applications assistance, customer product design, or damage to any equipment resulting from the use of Skyworks products outside of stated published specifications or parameters.

Skyworks, the Skyworks symbol, and "Breakthrough Simplicity" are trademarks or registered trademarks of Skyworks Solutions, Inc., in the United States and other countries. Third-party brands and names are for identification purposes only, and are the property of their respective owners. Additional information, including relevant terms and conditions, posted at www.skyworksinc.com, are incorporated by reference.