

### FEATURES

- Plastic package has Underwriters Laboratory flammability Classification 94V-0.
- Glass passivated chip junction.
- High surge overload rating : 50A peak.
- Ideal for printed circuit boards.
- High temperature soldering guaranteed : 260 /10 seconds, at 2.3kg tension.

### MAXIMUM RATING (Ta=25 )

CHARACTERISTIC	SYMBOL	RATING	UNIT
Repetitive peak reverse voltage	$V_{RRM}$	600	V
RMS voltage	$V_{RMS}$	420	V
DC blocking voltage	$V_{DC}$	600	V
Average forward output rectified current at Ta=40	$I_{AV}$	1	A
Peak forward surge current 8.3ms single half sine-wave superimposed on rated load $T_L=110$	$I_{FSM}$	5	A
Rating for fusing (t<8.3ms)	$I_t$	10	A sec
Operating Junction and Storage Temperature Range	$T_j, T_{stg}$	-5 ~ 100	°C

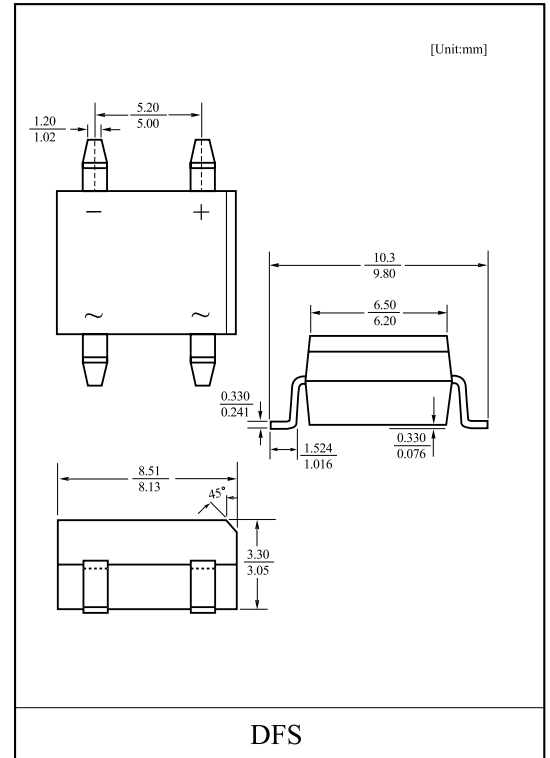

Marking

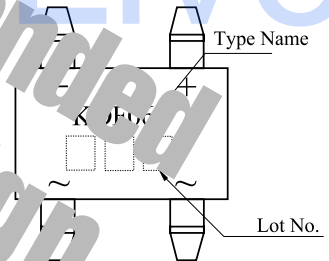

### ELECTRICAL CHARACTERISTICS (Ta=25 )

CHARACTERISTIC	SYMBOL	CONDITION	MIN	TYP	MAX	UNIT
Forward voltage	$V_F$	$I_F=1A$	-	-	1.1	V
Leakage current	$I_R$	$V_R=600V$	-	-	5	$\mu A$
			-	-	500	
Junction capacitance	$C_J$	$V_R=4.0V, f=1MHz$	-	25	-	pF
Thermal resistance	$R_{th}(A)$ (Note1)	Junction to ambient	-	-	40	/W
	$R_{th}(L)$ (Note1)	Junction to lead	-	-	15	

Note 1) Thermal resistance from junction to ambient and from junction to lead mounted on P.C.B with (13 × 13mm) copper pads.

Fig.1 Derating Curve Output Rectified Current

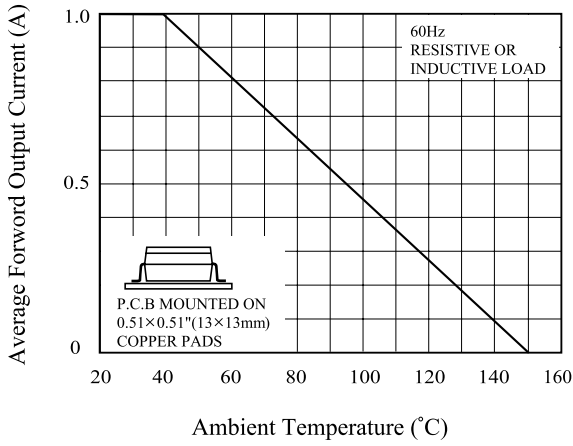

Fig.2 Maximum Non-Repetitive Peak Forward Surge Current Per Leg

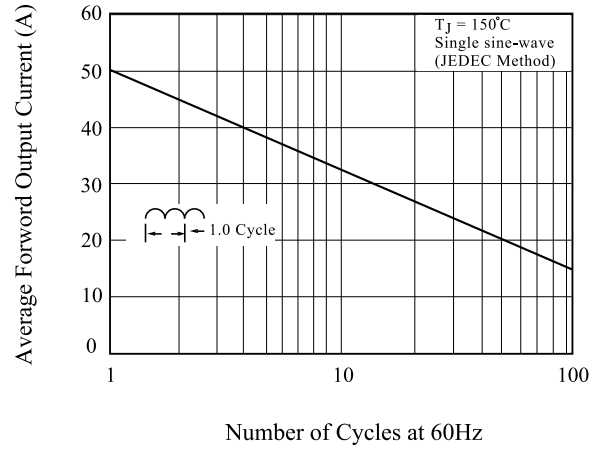

Fig.3 Typical Forward Characteristics Per Leg

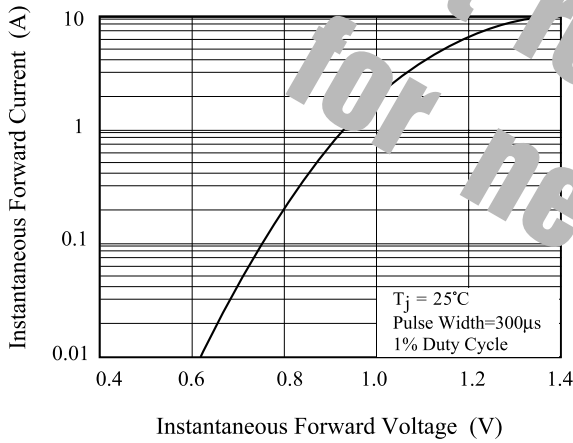

Fig.4 Typical Reverse Leakage Characteristics Per Leg

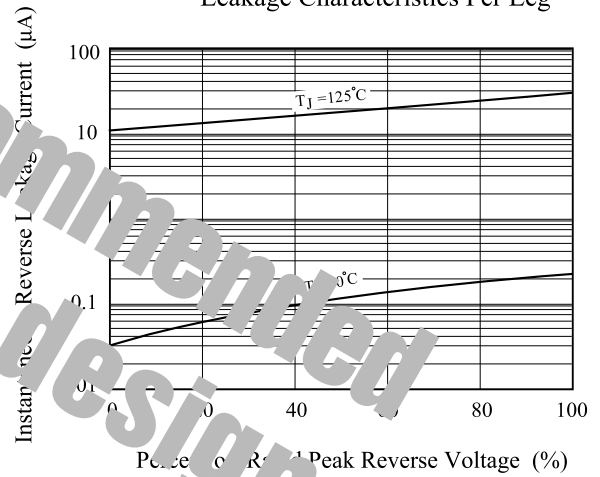

Fig.5 Typical Junction Capacitance Per Leg

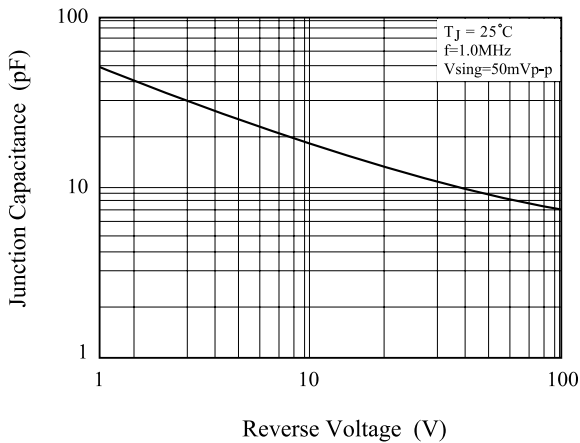

Fig.6 Typical Transient Thermal Impedance

