

# INTERNATIONAL RECTIFIER

## 1N2054, 1N3735 SERIES 250 Amp Avg Power Silicon Rectifier Diodes

### Major Ratings and Characteristics

	1N2054	1N3735	Units
$I_{F(AV)}$	250*	250*	A
@ Max. $T_C$	135*	130*	$^{\circ}C$
$I_{FSM}$ @ 50 Hz	4300	4300	A
@ 60 Hz	4500*	4500*	
$I^2t$ @ 50 Hz	92500	92500	$A^2s$
@ 60 Hz	84500	84500	
$I^2\sqrt{t}$	1300000	1300000	$A^2\sqrt{s}$
$V_{RRM}$ Range	50*-1000*	100*-1200*	V

\*JEDEC registered values.

### Description and Features

- Popular DO-9 package
- Voltage ratings from 50 to 1200 volts

### CASE STYLE AND DIMENSIONS

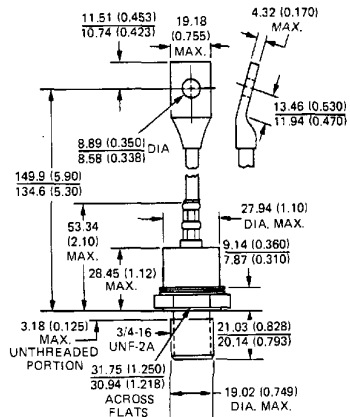
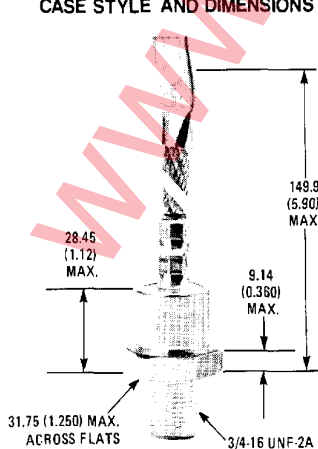

Conforms to JEDEC outline DO-205AB (DO-9) (IR B-13)

Dimensions in Millimeters and (Inches)

Refer to page B-78 for additional case style.

**VOLTAGE RATINGS**

Part Number		$V_{RRM}$ - Max. Repetitive Peak Reverse Voltage (V)	$V_{RSM}$ - Max. Non-repetitive Peak Reverse Voltage $t_p \leq 5$ ms (V)	$V_R$ - Max. Direct Reverse Voltage (V)	$I_{R(AV)}$ Max. Average Reverse Current @ Max. Rated $I_F(AV)$ and $V_{RRM}$ 1 Phase Operation (mA)
Cathode-to-Stud	Anode-to-Stud				
		$T_C = -65$ to $200^\circ\text{C}$		$T_C = -65$ to $200^\circ\text{C}$	$T_C = 135^\circ\text{C}$
1N2054	1N2054R	50*	—	40*	25*
1N2055	1N2055R	100*	—	80*	25*
1N2057	1N2057R	200*	—	160*	17*
1N2059	1N2059R	300*	—	240*	17*
1N2061	1N2061R	400*	—	320*	17*
1N2064	1N2064R	600*	—	480*	17*
1N2066	1N2066R	800*	—	640*	16*
1N2067	1N2067R	900*	—	720*	14*
1N2068	1N2068R	1000*	—	800*	12*
		$T_C = -40$ to $200^\circ\text{C}$	$T_C = 25$ to $200^\circ\text{C}$	$T_C = -40$ to $200^\circ\text{C}$	$T_C = 130^\circ\text{C}$
1N3735	1N3735R	100*	200*	100*	16*
1N3736	1N3736R	200*	300*	200*	16*
1N3737	1N3737R	300*	400*	300*	16*
1N3738	1N3738R	400*	525*	400*	16*
1N3739	1N3739R	500*	650*	500*	13*
1N3740	1N3740R	600*	800*	600*	12*
1N3741	1N3741R	800*	1050*	800*	9*
1N3742	1N3742R	1000*	1300*	1000*	7*
1N3743 ①	1N3743R ①	1200*	1600*	1200*	7*

**ELECTRICAL SPECIFICATIONS**

	1N2054	1N3735	Units	Conditions
$I_F(AV)$ Max. average forward current	250*	250*	A	1 phase operation, $180^\circ$ conduction 1N2050 series: max. $T_C = 135^\circ\text{C}$ 1N3735 series: max. $T_C = 130^\circ\text{C}$
$I_{FSM}$ Max. peak one-cycle non-repetitive surge current	4300	4300	A	Half cycle 50 Hz sine wave or 6 ms rectangular pulse Following any rated load condition and with rated $V_{RRM}$ applied
	4500*	4500*		Half cycle 60 Hz sine wave or 5 ms rectangular pulse Following any rated load condition and with $V_{RRM}$ applied
	5100	5100		Half cycle 50 Hz sine wave or 6 ms rectangular pulse Following any rated load condition and with $V_{RRM}$ applied following surge = 0.
	5350	5350		Half cycle 60 Hz sine wave or 5 ms rectangular pulse Applied following surge = 0.
$I^2t$ Max. $I^2t$ for fusing	92,500	92,500	$A^2s$	$t = 10$ ms With rated $V_{RRM}$ applied following surge, initial $T_J = 200^\circ\text{C}$
	84,500	84,500		$t = 10$ ms With $V_{RRM} = 0$ following surge, initial $T_J = 200^\circ\text{C}$
	130,000	130,000		$t = 8.3$ ms
Max. $I^2t$ for individual device fusing	120,000	120,000		$t = 0.1$ to $10$ ms, $V_{RRM} = 0$ following surge.
$I^2 \sqrt{t}$ Max. $I^2 \sqrt{t}$ for individual device fusing ①	1,300,000	1,300,000	$A^2 \sqrt{s}$	
$V_{FM}$ Max. peak forward voltage	1.25*	—	V	$I_F(AV) = 250A$ (785A peak), $T_C = 135^\circ\text{C}$ *
	—	1.3*	V	$I_F(AV) = 250A$ (785A peak), $T_C = 130^\circ\text{C}$ *

**THERMAL-MECHANICAL SPECIFICATIONS**

$T_C$ Max. operating case temperature range	$-65^\circ$ to $200^\circ$	$-40^\circ$ to $200^\circ$	$^\circ\text{C}$	
$T_{stg}$ Max. storage temperature range	$-65^\circ$ to $200^\circ$	$-40^\circ$ to $200^\circ$	$^\circ\text{C}$	
$R_{thJC}$ Max. internal thermal resistance, junction-to-case	0.18*	0.18*	deg C/W	DC operation.
	—	0.24*		One- and three-phase operation.
	—	0.30*		Six-phase operation.
$R_{thCS}$ Thermal resistance, case-to-sink	0.08	0.08	deg C/W	Mounting surface flat, smooth and greased.
$T$ Mounting torque	31.1–36.7 (275–325)		N•m (lbf•in.)	
wt Approximate weight	213 (7.5)		g (oz)	
Case Style	DO-205AB (DO-8) (IR B-13) ①			JEDEC

\* JEDEC registered values.

① 1N3743,R may be furnished in DO-9 (IR B-6) package.

 ②  $I^2t$  for time  $t_x = I^2 \sqrt{t} \cdot \sqrt{t_x}$ .

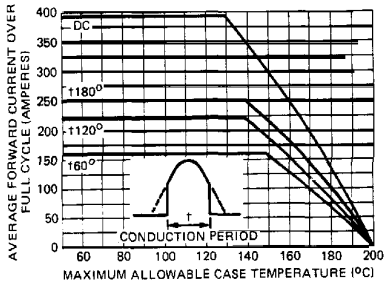

Fig. 1 – Average Forward Current Vs. Maximum Allowable Case Temperature (Sinusoidal Current Waveform)

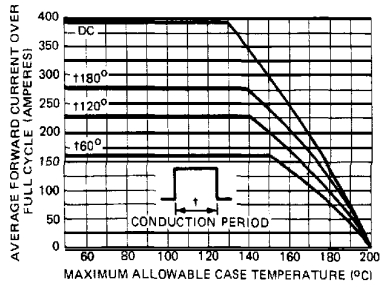

Fig. 2 – Average Forward Current Vs. Maximum Allowable Case Temperature (Rectangular Current Waveform)

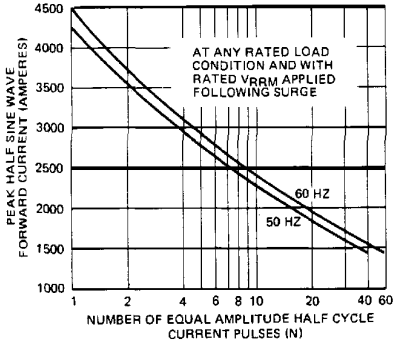

Fig. 3 – Maximum Non-Repetitive Surge Current Vs. Number of Current Pulses

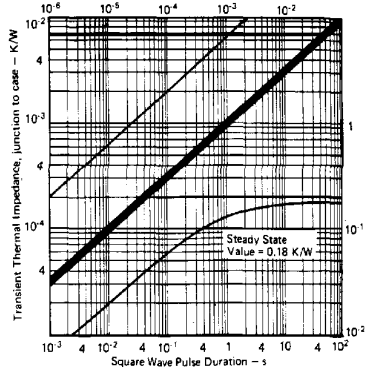

Fig. 4 – Maximum Transient Thermal Impedance, Junction-to-Case Vs. Pulse Duration

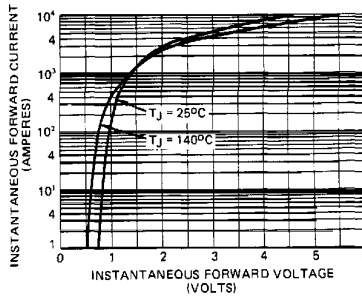

Fig. 5 – Maximum Forward Voltage Vs. Forward Current

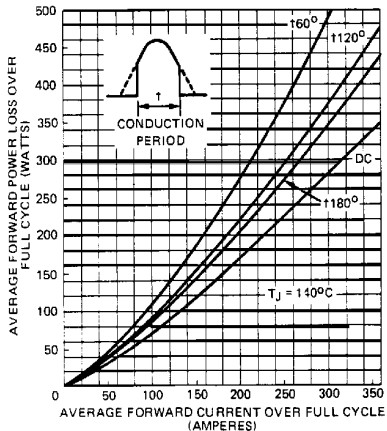

Fig. 6 – Maximum Low Level Forward Power Loss Vs. Average Forward Current (Sinusoidal Current Waveform)

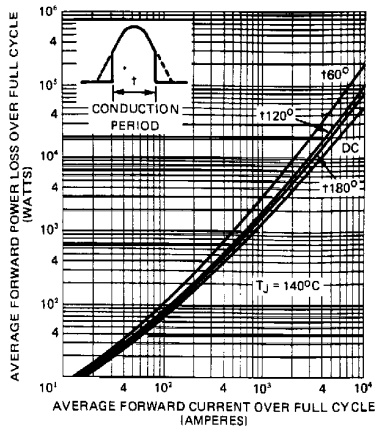

Fig. 7 – Maximum High Level Forward Power Loss Vs. Average Forward Current (Sinusoidal Current Waveform)

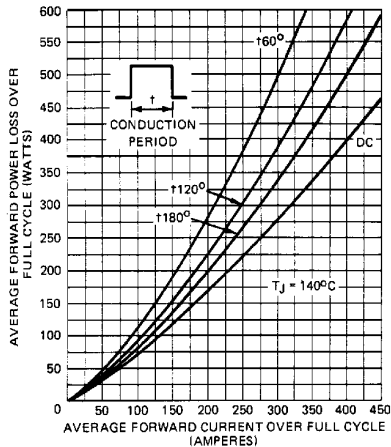

Fig. 8 – Maximum Low Level Forward Power Loss Vs. Average Forward Current (Rectangular Current Waveform)

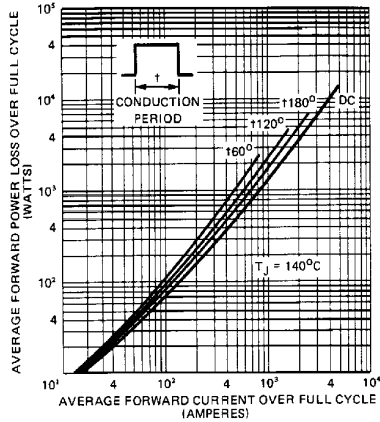
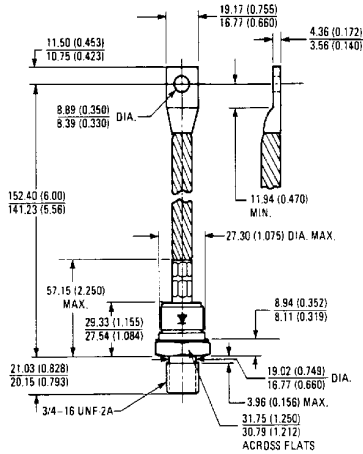

Fig. 9 – Maximum High Level Forward Power Loss Vs. Average Forward Current (Rectangular Current Waveform)



Conforms to JEDEC outline DO-205AB (DO-9) (IR B-6)  
 All Dimensions in Millimeters and (Inches)