

NPN Silicon Darlington Transistors

- For general AF applications
- High collector current
- High current gain
- Complementary types: BCV26, BCV46 (PNP)

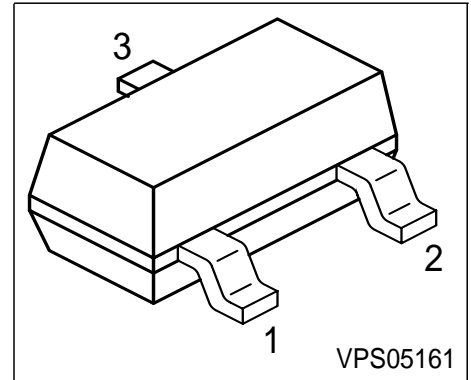

| Type | Marking | Pin Configuration | | | Package |
|-------|---------|-------------------|-------|-------|---------|
| BCV27 | FFs | 1 = B | 2 = E | 3 = C | SOT23 |
| BCV47 | FGs | 1 = B | 2 = E | 3 = C | SOT23 |

Maximum Ratings

| Parameter | Symbol | BCV27 | BCV47 | Unit |
|---|-----------|-------------|-------|------|
| Collector-emitter voltage | V_{CEO} | 30 | 60 | V |
| Collector-base voltage | V_{CBO} | 40 | 80 | |
| Emitter-base voltage | V_{EBO} | 10 | 10 | |
| DC collector current | I_C | 500 | | mA |
| Peak collector current | I_{CM} | 800 | | mA |
| Base current | I_B | 100 | | |
| Peak base current | I_{BM} | 200 | | |
| Total power dissipation, $T_S = 74\text{ °C}$ | P_{tot} | 360 | | mW |
| Junction temperature | T_j | 150 | | °C |
| Storage temperature | T_{stg} | -65 ... 150 | | |

Thermal Resistance

| | | | |
|--|------------|------|-----|
| Junction - soldering point ¹⁾ | R_{thJS} | ≤210 | K/W |
|--|------------|------|-----|

¹⁾For calculation of R_{thJA} please refer to Application Note Thermal Resistance

Electrical Characteristics at $T_A = 25^\circ\text{C}$, unless otherwise specified.

| Parameter | Symbol | Values | | | Unit |
|--|---------------|--------|------|------|---------------|
| | | min. | typ. | max. | |
| DC Characteristics | | | | | |
| Collector-emitter breakdown voltage $I_C = 10\text{ mA}, I_B = 0$ | $V_{(BR)CEO}$ | | | | V |
| BCV27 | | 30 | - | - | |
| BCV47 | | 60 | - | - | |
| Collector-base breakdown voltage $I_C = 100\text{ }\mu\text{A}, I_B = 0$ | $V_{(BR)CBO}$ | | | | |
| BCV27 | | 40 | - | - | |
| BCV47 | | 80 | - | - | |
| Emitter-base breakdown voltage $I_E = 10\text{ }\mu\text{A}, I_C = 0$ | $V_{(BR)EBO}$ | 10 | - | - | |
| Collector cutoff current $V_{CB} = 30\text{ V}, I_E = 0$ | I_{CBO} | | | | nA |
| BCV27 | | - | - | 100 | |
| $V_{CB} = 60\text{ V}, I_E = 0$ | BCV47 | | | 100 | |
| Collector cutoff current $V_{CB} = 30\text{ V}, I_E = 0, T_A = 150\text{ }^\circ\text{C}$ | I_{CBO} | | | | μA |
| BCV27 | | - | - | 10 | |
| $V_{CB} = 60\text{ V}, I_E = 0, T_A = 150\text{ }^\circ\text{C}$ | BCV47 | | | 10 | |
| Emitter cutoff current $V_{EB} = 4\text{ V}, I_C = 0$ | I_{EBO} | - | - | 100 | nA |
| DC current gain 1) $I_C = 100\text{ }\mu\text{A}, V_{CE} = 1\text{ V}$ | h_{FE} | | | | - |
| BCV27 | | 4000 | - | - | |
| BCV47 | | 2000 | - | - | |
| DC current gain 1) $I_C = 10\text{ mA}, V_{CE} = 5\text{ V}$ | h_{FE} | | | | |
| BCV27 | | 10000 | - | - | |
| BCV47 | | 4000 | - | - | |
| DC current gain 1) $I_C = 100\text{ mA}, V_{CE} = 5\text{ V}$ | h_{FE} | | | | |
| BCV27 | | 20000 | - | - | |
| BCV47 | | 10000 | - | - | |
| DC current gain 1) $I_C = 0.5\text{ A}, V_{CE} = 5\text{ V}$ | h_{FE} | | | | |
| BCV27 | | 4000 | - | - | |
| BCV47 | | 2000 | - | - | |

 1) Pulse test: $t \leq 300\mu\text{s}$, $D = 2\%$

Electrical Characteristics at $T_A = 25^\circ\text{C}$, unless otherwise specified.

| Parameter | Symbol | Values | | | Unit |
|--|-------------|--------|------|------|------|
| | | min. | typ. | max. | |
| DC Characteristics | | | | | |
| Collector-emitter saturation voltage ¹⁾ $I_C = 100\text{ mA}, I_B = 0.1\text{ mA}$ | V_{CEsat} | - | - | 1 | V |
| Base-emitter saturation voltage 1) $I_C = 100\text{ mA}, I_B = 0.1\text{ mA}$ | V_{BEsat} | - | - | 1.5 | |
| AC Characteristics | | | | | |
| Transition frequency $I_C = 50\text{ mA}, V_{CE} = 5\text{ V}, f = 100\text{ MHz}$ | f_T | - | 170 | - | MHz |
| Collector-base capacitance $V_{CB} = 10\text{ V}, f = 1\text{ MHz}$ | C_{cb} | - | 3.5 | - | pF |

1) Pulse test: $t \leq 300\mu\text{s}$, $D = 2\%$

Total power dissipation $P_{tot} = f(T_S)$

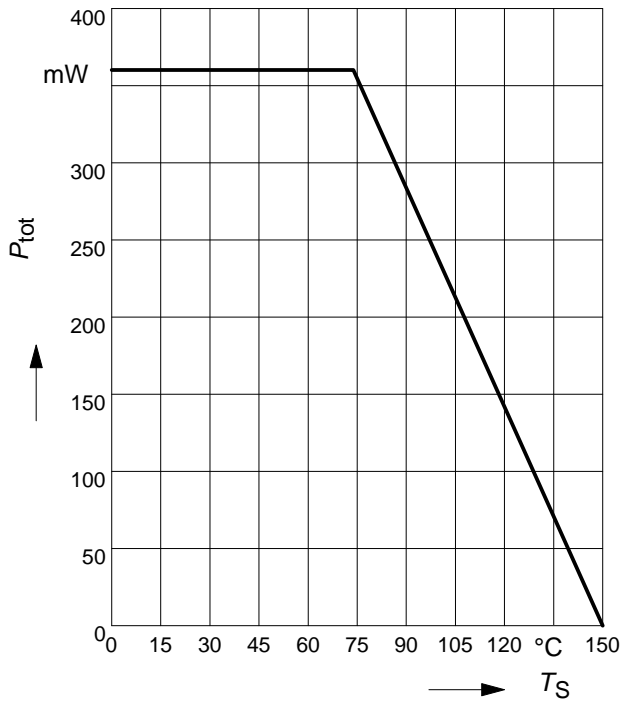

**Collector-base capacitance $C_{CB} = f(V_{CB0})$
Emitter-base capacitance $C_{EB} = f(V_{EB0})$**

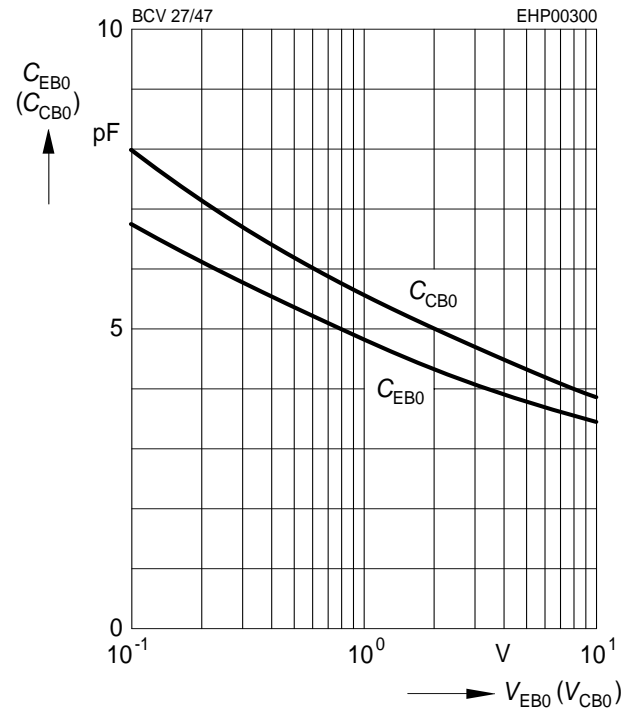

Permissible pulse load

$P_{totmax} / P_{totDC} = f(t_p)$

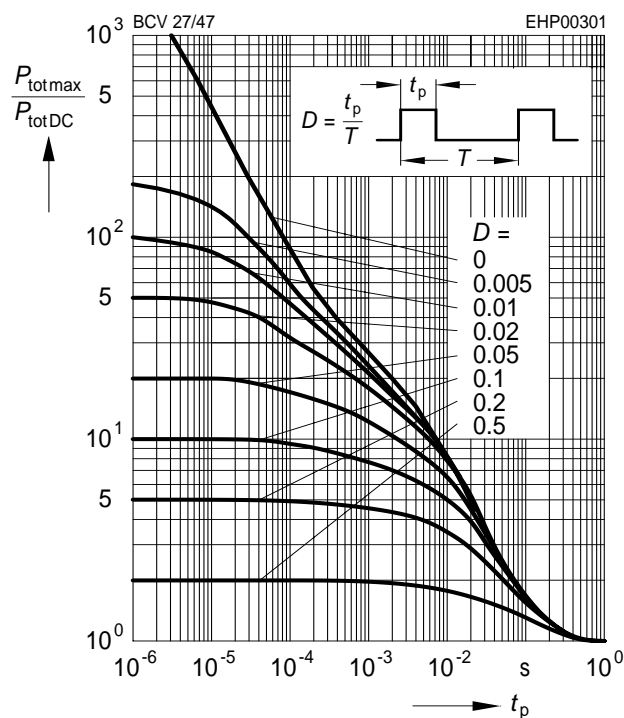

Transition frequency $f_T = f(I_C)$

$V_{CE} = 5V$

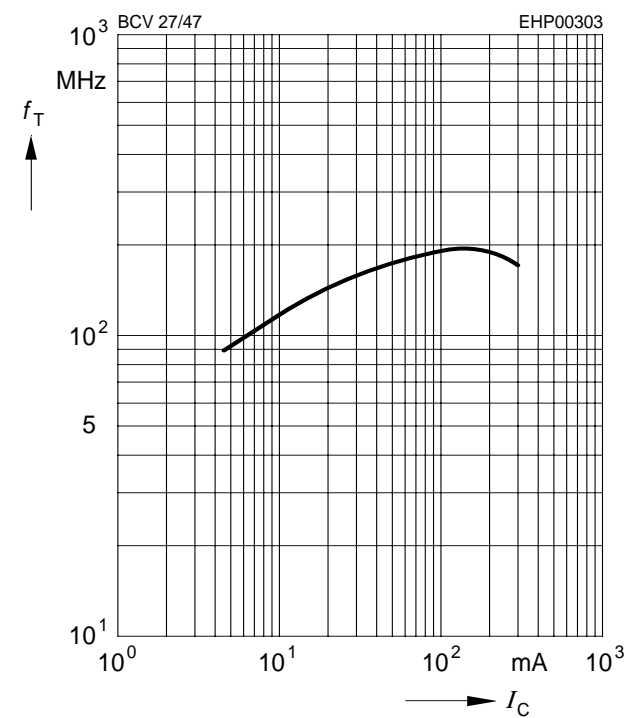

Base-emitter saturation voltage

$I_C = f(V_{BEsat}), h_{FE} = 1000$

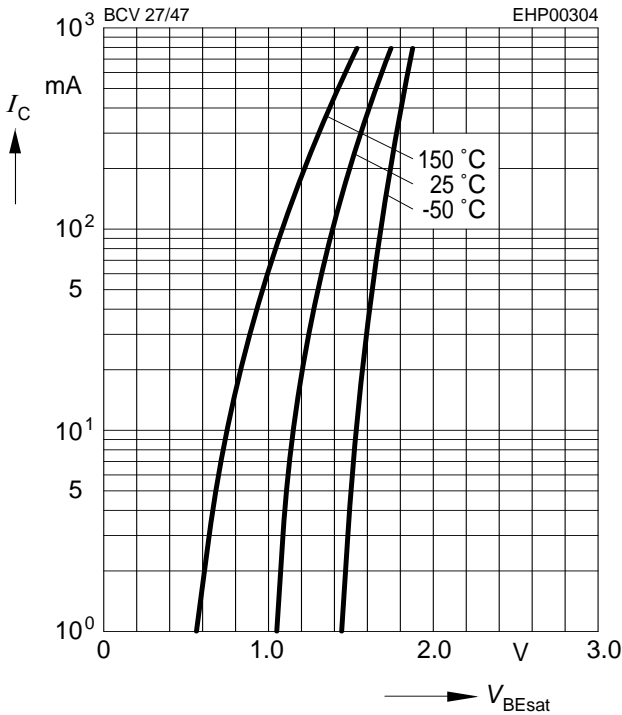

Collector-emitter saturation voltage

$I_C = f(V_{CEsat}), h_{FE} = 1000$

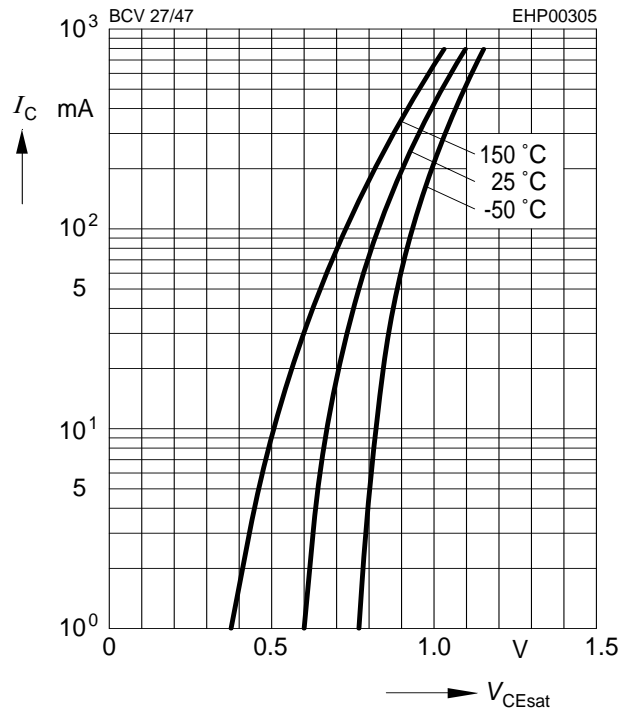

Collector cutoff current $I_{CBO} = f(T_A)$

$V_{CB} = V_{CEmax}$

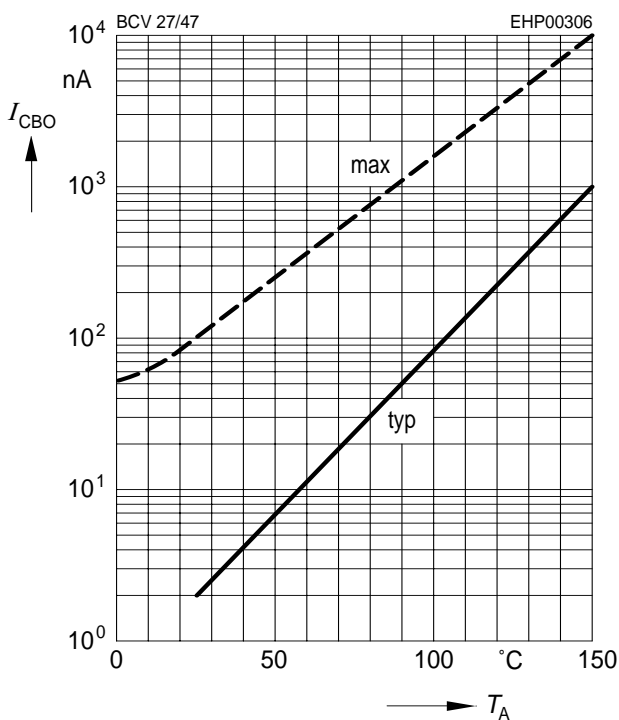

DC current gain $h_{FE} = f(I_C)$

$V_{CE} = 5V$

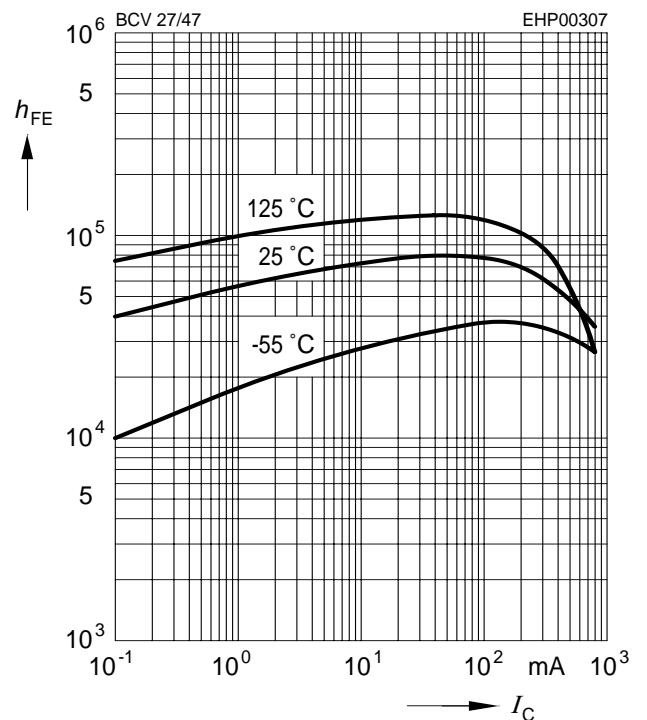

Package Outline

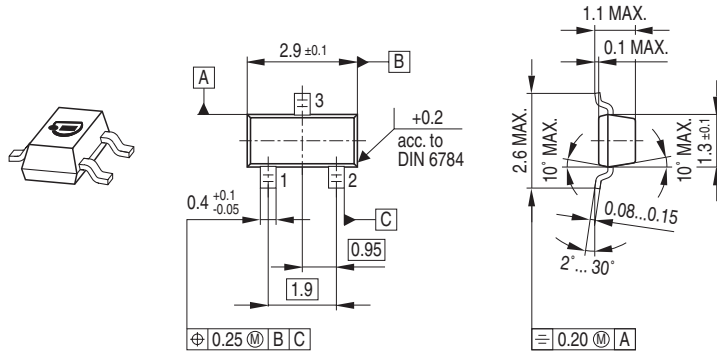

Foot Print

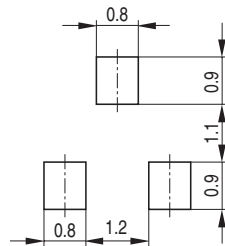

Marking Layout

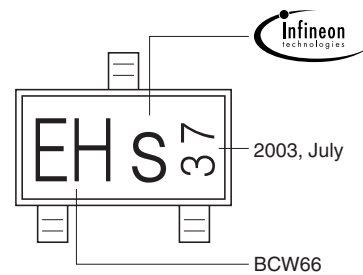
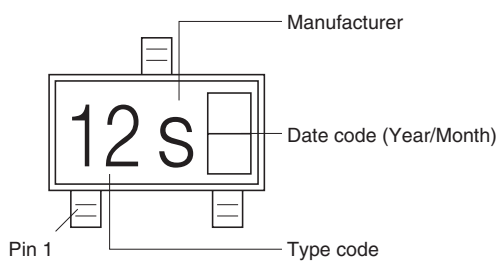

Example

Packing

Code E6327: Reel \varnothing 180 mm = 3.000 Pieces/Reel

Code E6433: Reel \varnothing 330 mm = 10.000 Pieces/Reel

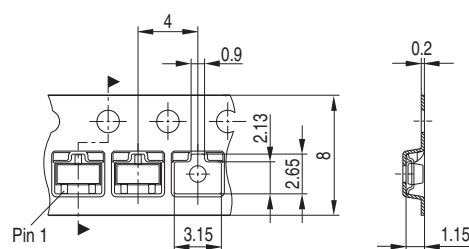

Published by Infineon Technologies AG,
St.-Martin-Strasse 53,
81669 München
© Infineon Technologies AG 2005.
All Rights Reserved.

Attention please!

The information herein is given to describe certain components and shall not be considered as a guarantee of characteristics.

Terms of delivery and rights to technical change reserved.

We hereby disclaim any and all warranties, including but not limited to warranties of non-infringement, regarding circuits, descriptions and charts stated herein.

Information

For further information on technology, delivery terms and conditions and prices please contact your nearest Infineon Technologies Office (www.infineon.com).

Warnings

Due to technical requirements components may contain dangerous substances. For information on the types in question please contact your nearest Infineon Technologies Office.

Infineon Technologies Components may only be used in life-support devices or systems with the express written approval of Infineon Technologies, if a failure of such components can reasonably be expected to cause the failure of that life-support device or system, or to affect the safety or effectiveness of that device or system. Life support devices or systems are intended to be implanted in the human body, or to support and/or maintain and sustain and/or protect human life. If they fail, it is reasonable to assume that the health of the user or other persons may be endangered.