

Features

- Glass Passivated Die Construction
- 3000W Peak Pulse Power Dissipation
- 5.0V – 170V Standoff Voltage
- Uni- and Bi-Directional Versions Available
- Excellent Clamping Capability
- Fast Response Time
- Plastic Case Material has UL Flammability Classification Rating 94V-O

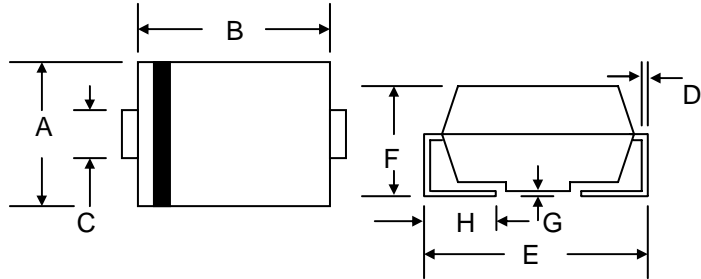

Mechanical Data

- Case: SMC/DO-214AB, Molded Plastic
- Terminals: Solder Plated, Solderable per MIL-STD-750, Method 2026
- Polarity: Cathode Band Except Bi-Directional
- Marking: Device Code
- Weight: 0.21 grams (approx.)
- **Lead Free: For RoHS / Lead Free Version, Add "-LF" Suffix to Part Number, See Page 6**

| SMC/DO-214AB | | |
|----------------------|-------|-------|
| Dim | Min | Max |
| A | 5.59 | 6.22 |
| B | 6.60 | 7.11 |
| C | 2.75 | 3.25 |
| D | 0.152 | 0.305 |
| E | 7.75 | 8.13 |
| F | 2.00 | 2.62 |
| G | 0.051 | 0.203 |
| H | 0.76 | 1.27 |
| All Dimensions in mm | | |

DatasheetLive

"C" Suffix Designates Bi-directional Devices
 "A" Suffix Designates 5% Tolerance Devices
 No Suffix Designates 10% Tolerance Devices

Maximum Ratings and Electrical Characteristics @ $T_A=25^\circ\text{C}$ unless otherwise specified

| Characteristic | Symbol | Value | Unit |
|--|-----------------|--------------|--------------------|
| Peak Pulse Power Dissipation 10/1000 μs Waveform (Note 1, 2) Figure 3 | PPPM | 3000 Minimum | W |
| Peak Pulse Current on 10/1000 μs Waveform (Note 1) Figure 4 | IPPM | See Table 1 | A |
| Peak Forward Surge Current 8.3ms Single Half Sine-Wave Superimposed on Rated Load (JEDEC Method) (Note 2, 3) | IFSM | 200 | A |
| Typical Thermal Resistance Junction to Ambient | $R_{\theta JA}$ | 25 | $^\circ\text{C/W}$ |
| Operating and Storage Temperature Range | T_j, T_{STG} | -55 to +150 | $^\circ\text{C}$ |

- Note: 1. Non-repetitive current pulse per Figure 4 and derated above $T_A = 25^\circ\text{C}$ per Figure 1.
 2. Mounted on 8.0mm² (0.013mm thick) copper pad to each terminal.
 3. Measured on 8.3ms single half sine-wave or equivalent square wave, duty cycle = 4 pulses per minutes maximum.

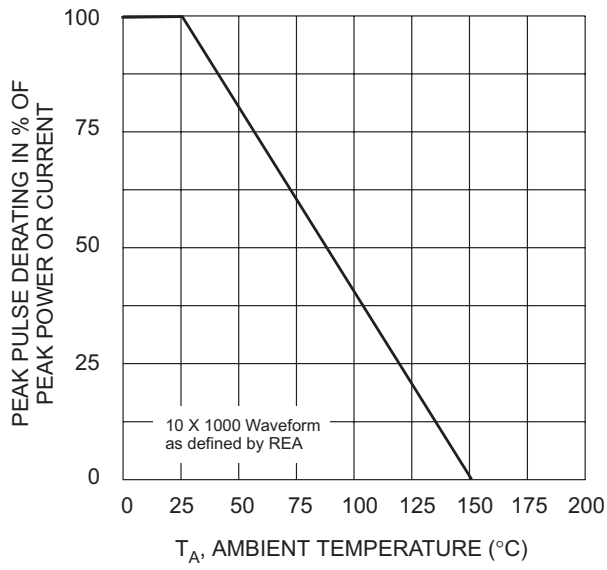

Fig. 1 Pulse Derating Curve

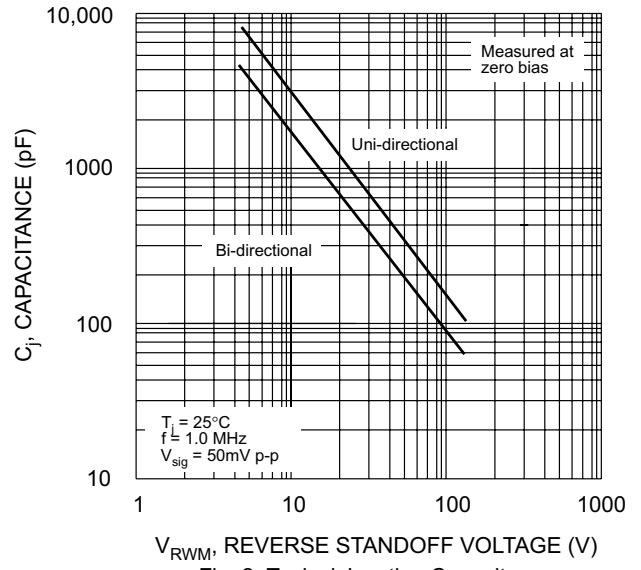

Fig. 2 Typical Junction Capacitance

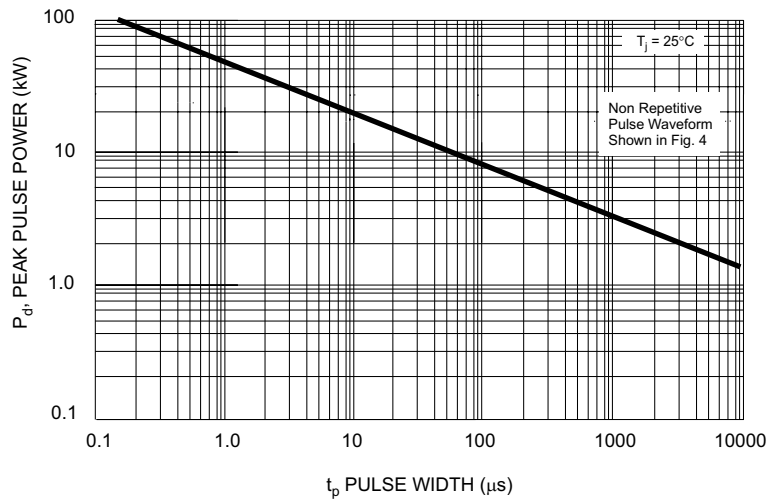

Fig. 3 Pulse Rating Curve

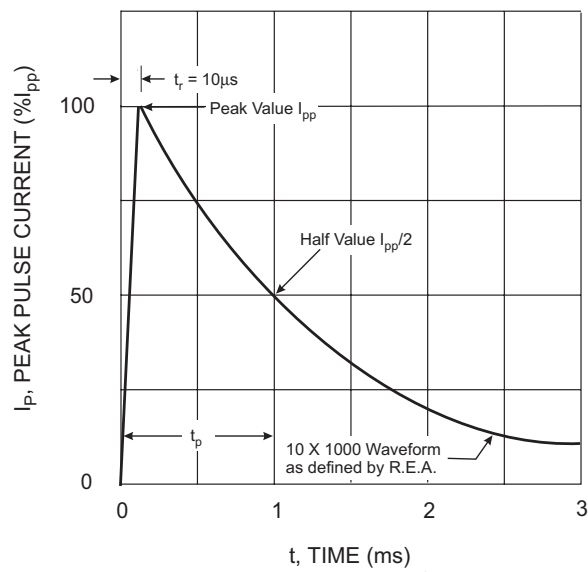

Fig. 4 Pulse Waveform

UNI-DIRECTIONAL 3000 WATT SURFACE MOUNT TVS

| UNI-DIRECTIONAL PART NO. | DEVICE MARKING CODE | REVERSE STAND-OFF VOLTAGE VRWM (V) | BREAKDOWN VOLTAGE VBR (V) MIN. @IT | BREAKDOWN VOLTAGE VBR (V) MAX. @IT | TEST CURRENT IT (mA) | MAXIMUM CLAMPING VOLTAGE @Ipp Vc (V) | PEAK PULSE CURRENT Ipp (A) | REVERSE LEAKAGE @VRWM IR (uA) |
|--------------------------|---------------------|------------------------------------|------------------------------------|------------------------------------|----------------------|--------------------------------------|----------------------------|-------------------------------|
| 3.0SMCJ5.0 | HDD | 5.00 | 6.40 | 7.30 | 10 | 9.6 | 312.5 | 1000 |
| 3.0SMCJ5.0A | HDE | 5.00 | 6.40 | 7.00 | 10 | 9.2 | 326.0 | 1000 |
| 3.0SMCJ6.0 | HDF | 6.00 | 6.67 | 8.15 | 10 | 11.4 | 263.2 | 1000 |
| 3.0SMCJ6.0A | HDG | 6.00 | 6.67 | 7.37 | 10 | 10.3 | 291.3 | 1000 |
| 3.0SMCJ6.5 | HDH | 6.50 | 7.22 | 8.82 | 10 | 12.3 | 243.9 | 500 |
| 3.0SMCJ6.5A | HDK | 6.50 | 7.22 | 7.98 | 10 | 11.2 | 267.9 | 500 |
| 3.0SMCJ7.0 | HDL | 7.00 | 7.78 | 9.51 | 10 | 13.3 | 225.6 | 200 |
| 3.0SMCJ7.0A | HDM | 7.00 | 7.78 | 8.60 | 10 | 12.0 | 250.0 | 200 |
| 3.0SMCJ7.5 | HDN | 7.50 | 8.33 | 10.20 | 1 | 14.3 | 209.8 | 100 |
| 3.0SMCJ7.5A | HDP | 7.50 | 8.33 | 9.21 | 1 | 12.9 | 232.6 | 100 |
| 3.0SMCJ8.0 | HDQ | 8.00 | 8.89 | 10.90 | 1 | 15.0 | 200.0 | 50 |
| 3.0SMCJ8.0A | HDR | 8.00 | 8.89 | 9.83 | 1 | 13.6 | 220.6 | 50 |
| 3.0SMCJ8.5 | HDS | 8.50 | 9.44 | 11.50 | 1 | 15.9 | 188.8 | 25 |
| 3.0SMCJ8.5A | HDT | 8.50 | 9.44 | 10.40 | 1 | 14.4 | 208.4 | 25 |
| 3.0SMCJ9.0 | HDU | 9.00 | 10.00 | 12.20 | 1 | 16.9 | 177.4 | 10 |
| 3.0SMCJ9.0A | HDV | 9.00 | 10.00 | 11.10 | 1 | 15.4 | 194.8 | 10 |
| 3.0SMCJ10 | HDW | 10.00 | 11.10 | 13.60 | 1 | 18.8 | 159.6 | 5 |
| 3.0SMCJ10A | HDX | 10.00 | 11.10 | 12.30 | 1 | 17.0 | 176.4 | 5 |
| 3.0SMCJ11 | HDY | 11.00 | 12.20 | 14.90 | 1 | 20.1 | 149.2 | 5 |
| 3.0SMCJ11A | HDZ | 11.00 | 12.20 | 13.50 | 1 | 18.2 | 184.8 | 5 |
| 3.0SMCJ12 | HED | 12.00 | 13.30 | 16.30 | 1 | 22.0 | 136.4 | 5 |
| 3.0SMCJ12A | HEE | 12.00 | 13.30 | 14.70 | 1 | 19.9 | 150.6 | 5 |
| 3.0SMCJ13 | HEF | 13.00 | 14.40 | 17.60 | 1 | 23.8 | 126.0 | 5 |
| 3.0SMCJ13A | HEG | 13.00 | 14.40 | 15.90 | 1 | 21.5 | 139.4 | 5 |
| 3.0SMCJ14 | HEH | 14.00 | 15.60 | 19.10 | 1 | 25.8 | 116.2 | 5 |
| 3.0SMCJ14A | HEK | 14.00 | 15.60 | 17.20 | 1 | 23.2 | 129.4 | 5 |
| 3.0SMCJ15 | HEL | 15.00 | 16.70 | 20.40 | 1 | 26.9 | 111.6 | 5 |
| 3.0SMCJ15A | HEM | 15.00 | 16.70 | 18.50 | 1 | 24.4 | 123.0 | 5 |
| 3.0SMCJ16 | HEN | 16.00 | 17.80 | 21.80 | 1 | 28.8 | 104.2 | 5 |
| 3.0SMCJ16A | HEP | 16.00 | 17.80 | 19.70 | 1 | 26.0 | 115.4 | 5 |
| 3.0SMCJ17 | HEQ | 17.00 | 18.90 | 23.10 | 1 | 30.5 | 98.4 | 5 |
| 3.0SMCJ17A | HER | 17.00 | 18.90 | 20.90 | 1 | 27.6 | 106.6 | 5 |
| 3.0SMCJ18 | HES | 18.00 | 20.00 | 24.40 | 1 | 32.2 | 93.2 | 5 |
| 3.0SMCJ18A | HET | 18.00 | 20.00 | 22.10 | 1 | 29.2 | 102.8 | 5 |
| 3.0SMCJ20 | HEU | 20.00 | 22.20 | 27.10 | 1 | 35.8 | 83.8 | 5 |
| 3.0SMCJ20A | HEV | 20.00 | 22.20 | 24.50 | 1 | 32.4 | 92.6 | 5 |
| 3.0SMCJ22 | HEW | 22.00 | 24.40 | 29.80 | 1 | 39.4 | 76.2 | 5 |
| 3.0SMCJ22A | HEX | 22.00 | 24.40 | 26.90 | 1 | 35.5 | 84.4 | 5 |
| 3.0SMCJ24 | HEY | 24.00 | 26.70 | 32.60 | 1 | 43.0 | 69.8 | 5 |
| 3.0SMCJ24A | HEZ | 24.00 | 26.70 | 29.50 | 1 | 38.9 | 77.2 | 5 |
| 3.0SMCJ26 | HFD | 26.00 | 28.90 | 35.30 | 1 | 46.6 | 64.4 | 5 |
| 3.0SMCJ26A | HFE | 26.00 | 28.90 | 31.90 | 1 | 42.1 | 71.2 | 5 |
| 3.0SMCJ28 | HFF | 28.00 | 31.10 | 38.00 | 1 | 50.0 | 60.0 | 5 |
| 3.0SMCJ28A | HFG | 28.00 | 31.10 | 34.40 | 1 | 45.4 | 66.0 | 5 |
| 3.0SMCJ30 | HFH | 30.00 | 33.30 | 40.70 | 1 | 53.5 | 56.0 | 5 |
| 3.0SMCJ30A | HFJ | 30.00 | 33.30 | 36.80 | 1 | 48.4 | 62.0 | 5 |
| 3.0SMCJ33 | HFL | 33.00 | 36.70 | 44.90 | 1 | 59.0 | 50.4 | 5 |
| 3.0SMCJ33A | HFM | 33.00 | 36.70 | 40.60 | 1 | 53.3 | 56.2 | 5 |
| 3.0SMCJ36 | HFN | 36.00 | 40.00 | 48.90 | 1 | 64.3 | 46.6 | 5 |
| 3.0SMCJ36A | HFP | 36.00 | 40.00 | 44.20 | 1 | 58.1 | 51.6 | 5 |
| 3.0SMCJ40 | HFQ | 40.00 | 44.40 | 54.30 | 1 | 71.4 | 42.0 | 5 |
| 3.0SMCJ40A | HFR | 40.00 | 44.40 | 49.10 | 1 | 64.5 | 46.4 | 5 |
| 3.0SMCJ43 | HFS | 43.00 | 47.80 | 58.40 | 1 | 76.7 | 39.2 | 5 |
| 3.0SMCJ43A | HFT | 43.00 | 47.80 | 52.80 | 1 | 69.4 | 43.2 | 5 |
| 3.0SMCJ45 | HFU | 45.00 | 50.00 | 61.10 | 1 | 80.3 | 37.4 | 5 |
| 3.0SMCJ45A | HFV | 45.00 | 50.00 | 55.30 | 1 | 72.7 | 41.2 | 5 |
| 3.0SMCJ48 | HFW | 48.00 | 53.30 | 65.10 | 1 | 85.5 | 35.0 | 5 |
| 3.0SMCJ48A | HFY | 48.00 | 53.30 | 58.90 | 1 | 77.4 | 38.8 | 5 |
| 3.0SMCJ51 | HFZ | 51.00 | 56.70 | 69.30 | 1 | 91.1 | 37.0 | 5 |
| 3.0SMCJ51A | HFZ | 51.00 | 56.70 | 62.70 | 1 | 82.4 | 36.4 | 5 |
| 3.0SMCJ54 | HGD | 54.00 | 60.00 | 73.30 | 1 | 96.3 | 31.2 | 5 |
| 3.0SMCJ54A | HGE | 54.00 | 60.00 | 66.30 | 1 | 87.1 | 34.4 | 5 |
| 3.0SMCJ58 | HGF | 58.00 | 64.40 | 78.70 | 1 | 103.0 | 29.2 | 5 |
| 3.0SMCJ58A | HGG | 58.00 | 64.40 | 71.20 | 1 | 93.6 | 32.0 | 5 |
| 3.0SMCJ60 | HGH | 60.00 | 66.70 | 81.50 | 1 | 107.0 | 28.0 | 5 |
| 3.0SMCJ60A | HGK | 60.00 | 66.70 | 73.70 | 1 | 96.8 | 31.0 | 5 |
| 3.0SMCJ64 | HGL | 64.00 | 71.10 | 86.90 | 1 | 114.0 | 26.4 | 5 |
| 3.0SMCJ64A | HGM | 64.00 | 71.10 | 78.60 | 1 | 103.0 | 29.2 | 5 |
| 3.0SMCJ70 | HGN | 70.00 | 77.80 | 95.10 | 1 | 125.0 | 24.0 | 5 |
| 3.0SMCJ70A | HGP | 70.00 | 77.80 | 86.00 | 1 | 113.0 | 26.6 | 5 |
| 3.0SMCJ75 | HGQ | 75.00 | 83.30 | 102.00 | 1 | 134.0 | 22.4 | 5 |
| 3.0SMCJ75A | HGR | 75.00 | 83.30 | 92.10 | 1 | 121.0 | 24.8 | 5 |
| 3.0SMCJ78 | HGS | 78.00 | 86.70 | 106.00 | 1 | 139.0 | 21.6 | 5 |
| 3.0SMCJ78A | HGT | 78.00 | 86.70 | 95.80 | 1 | 126.0 | 22.8 | 5 |
| 3.0SMCJ85 | HGU | 85.00 | 94.40 | 115.00 | 1 | 151.0 | 19.8 | 5 |
| 3.0SMCJ85A | HGV | 85.00 | 94.40 | 104.00 | 1 | 137.0 | 20.8 | 5 |
| 3.0SMCJ90 | HGW | 90.00 | 100.00 | 122.00 | 1 | 160.0 | 18.8 | 5 |
| 3.0SMCJ90A | HGX | 90.00 | 100.00 | 111.00 | 1 | 146.0 | 20.6 | 5 |
| 3.0SMCJ100 | HGY | 100.00 | 111.00 | 136.00 | 1 | 179.0 | 16.6 | 5 |
| 3.0SMCJ100A | HGZ | 100.00 | 111.00 | 123.00 | 1 | 162.0 | 18.6 | 5 |
| 3.0SMCJ110 | HHD | 110.00 | 122.00 | 149.00 | 1 | 196.0 | 15.4 | 5 |
| 3.0SMCJ110A | HHE | 110.00 | 122.00 | 135.00 | 1 | 177.0 | 16.8 | 5 |
| 3.0SMCJ120 | HHF | 120.00 | 133.00 | 163.00 | 1 | 214.0 | 14.0 | 5 |
| 3.0SMCJ120A | HHG | 120.00 | 133.00 | 147.00 | 1 | 193.0 | 15.6 | 5 |
| 3.0SMCJ130 | HHH | 130.00 | 144.00 | 176.00 | 1 | 231.0 | 13.0 | 5 |
| 3.0SMCJ130A | HHK | 130.00 | 144.00 | 159.00 | 1 | 209.0 | 14.4 | 5 |
| 3.0SMCJ150 | HHL | 150.00 | 167.00 | 204.00 | 1 | 268.0 | 11.2 | 5 |
| 3.0SMCJ150A | HHM | 150.00 | 167.00 | 185.00 | 1 | 243.0 | 12.4 | 5 |
| 3.0SMCJ160 | HHN | 160.00 | 178.00 | 218.00 | 1 | 287.0 | 10.4 | 5 |
| 3.0SMCJ160A | HHP | 160.00 | 178.00 | 197.00 | 1 | 259.0 | 11.6 | 5 |
| 3.0SMCJ170 | HHQ | 170.00 | 189.00 | 231.00 | 1 | 304.0 | 9.8 | 5 |
| 3.0SMCJ170A | HHR | 170.00 | 189.00 | 209.00 | 1 | 275.0 | 11.0 | 5 |

BI-DIRECTIONAL 3000 WATT SURFACE MOUNT TVS

| BI-DIRECTIONAL PART NO. | DEVICE MARKING CODE | REVERSE STAND-OFF VOLTAGE VRWM (V) | BREAKDOWN VOLTAGE VBR (V) MIN. @IT | BREAKDOWN VOLTAGE VBR (V) MAX. @IT | TEST CURRENT IT (mA) | MAXIMUM CLAMPING VOLTAGE @Ipp Vc (V) | PEAK PULSE CURRENT Ipp (A) | REVERSE LEAKAGE @VRWM IR (uA) |
|-------------------------|---------------------|------------------------------------|------------------------------------|------------------------------------|----------------------|--------------------------------------|----------------------------|-------------------------------|
| 3.0SMCJ5.0C | IDD | 5.00 | 6.40 | 7.30 | 10 | 9.6 | 312.5 | 2000 |
| 3.0SMCJ5.0CA | IDE | 5.00 | 6.40 | 7.00 | 10 | 9.2 | 326.0 | 2000 |
| 3.0SMCJ6.0C | IDF | 6.00 | 6.67 | 8.15 | 10 | 11.4 | 263.2 | 2000 |
| 3.0SMCJ6.0CA | IDG | 6.00 | 6.67 | 7.37 | 10 | 10.3 | 291.3 | 2000 |
| 3.0SMCJ6.5C | IDH | 6.50 | 7.22 | 8.82 | 10 | 12.3 | 243.9 | 1000 |
| 3.0SMCJ6.5CA | IDK | 6.50 | 7.22 | 7.98 | 10 | 11.2 | 267.9 | 1000 |
| 3.0SMCJ7.0C | IDL | 7.00 | 7.78 | 9.51 | 10 | 13.3 | 225.6 | 400 |
| 3.0SMCJ7.0CA | IDM | 7.00 | 7.78 | 8.60 | 10 | 12.0 | 250.0 | 400 |
| 3.0SMCJ7.5C | IDN | 7.50 | 8.33 | 10.20 | 1 | 14.3 | 209.8 | 200 |
| 3.0SMCJ7.5CA | IDP | 7.50 | 8.33 | 9.21 | 1 | 12.9 | 232.6 | 200 |
| 3.0SMCJ8.0C | IDQ | 8.00 | 8.89 | 10.90 | 1 | 15.0 | 200.0 | 100 |
| 3.0SMCJ8.0CA | IDR | 8.00 | 8.89 | 9.83 | 1 | 13.6 | 220.6 | 100 |
| 3.0SMCJ8.5C | IDS | 8.50 | 9.44 | 11.50 | 1 | 15.9 | 188.8 | 50 |
| 3.0SMCJ8.5CA | IDT | 8.50 | 9.44 | 10.40 | 1 | 14.4 | 208.4 | 50 |
| 3.0SMCJ9.0C | IDU | 9.00 | 10.00 | 12.20 | 1 | 16.9 | 177.4 | 20 |
| 3.0SMCJ9.0CA | IDV | 9.00 | 10.00 | 11.10 | 1 | 15.4 | 194.8 | 20 |
| 3.0SMCJ10C | IDW | 10.00 | 11.10 | 13.60 | 1 | 18.8 | 159.6 | 5 |
| 3.0SMCJ10CA | IDX | 10.00 | 11.10 | 12.30 | 1 | 17.0 | 176.4 | 5 |
| 3.0SMCJ11C | IDY | 11.00 | 12.20 | 14.90 | 1 | 20.1 | 149.2 | 5 |
| 3.0SMCJ11CA | IDZ | 11.00 | 12.20 | 13.50 | 1 | 18.2 | 184.8 | 5 |
| 3.0SMCJ12C | IED | 12.00 | 13.30 | 16.30 | 1 | 22.0 | 136.4 | 5 |
| 3.0SMCJ12CA | IEE | 12.00 | 13.30 | 14.70 | 1 | 19.9 | 150.6 | 5 |
| 3.0SMCJ13C | IEF | 13.00 | 14.40 | 17.60 | 1 | 23.8 | 126.0 | 5 |
| 3.0SMCJ13CA | IEG | 13.00 | 14.40 | 15.90 | 1 | 21.5 | 139.4 | 5 |
| 3.0SMCJ14C | IEH | 14.00 | 15.60 | 19.10 | 1 | 25.8 | 116.2 | 5 |
| 3.0SMCJ14CA | IEK | 14.00 | 15.60 | 17.20 | 1 | 23.2 | 129.4 | 5 |
| 3.0SMCJ15C | IEL | 15.00 | 16.70 | 20.40 | 1 | 26.9 | 111.6 | 5 |
| 3.0SMCJ15CA | IEM | 15.00 | 16.70 | 18.50 | 1 | 24.4 | 123.0 | 5 |
| 3.0SMCJ16C | IEN | 16.00 | 17.80 | 21.80 | 1 | 28.8 | 104.2 | 5 |
| 3.0SMCJ16CA | IEP | 16.00 | 17.80 | 19.70 | 1 | 26.0 | 115.4 | 5 |
| 3.0SMCJ17C | IEQ | 17.00 | 18.90 | 23.10 | 1 | 30.5 | 98.4 | 5 |
| 3.0SMCJ17CA | IER | 17.00 | 18.90 | 20.90 | 1 | 27.6 | 106.6 | 5 |
| 3.0SMCJ18C | IES | 18.00 | 20.00 | 24.40 | 1 | 32.2 | 93.2 | 5 |
| 3.0SMCJ18CA | IET | 18.00 | 20.00 | 22.10 | 1 | 29.2 | 102.8 | 5 |
| 3.0SMCJ20C | IEU | 20.00 | 22.20 | 27.10 | 1 | 35.8 | 83.8 | 5 |
| 3.0SMCJ20CA | IEV | 20.00 | 22.20 | 24.50 | 1 | 32.4 | 92.6 | 5 |
| 3.0SMCJ22C | IEW | 22.00 | 24.40 | 29.80 | 1 | 39.4 | 76.2 | 5 |
| 3.0SMCJ22CA | IEX | 22.00 | 24.40 | 26.90 | 1 | 35.5 | 84.4 | 5 |
| 3.0SMCJ24C | IEY | 24.00 | 26.70 | 32.60 | 1 | 43.0 | 69.8 | 5 |
| 3.0SMCJ24CA | IEZ | 24.00 | 26.70 | 29.50 | 1 | 38.9 | 77.2 | 5 |
| 3.0SMCJ26C | IFD | 26.00 | 28.90 | 35.30 | 1 | 46.6 | 64.4 | 5 |
| 3.0SMCJ26CA | IFE | 26.00 | 28.90 | 31.90 | 1 | 42.1 | 71.2 | 5 |
| 3.0SMCJ28C | IFF | 28.00 | 31.10 | 38.00 | 1 | 50.0 | 60.0 | 5 |
| 3.0SMCJ28CA | IFG | 28.00 | 31.10 | 34.40 | 1 | 45.4 | 66.0 | 5 |
| 3.0SMCJ30C | IFH | 30.00 | 33.30 | 40.70 | 1 | 53.5 | 56.0 | 5 |
| 3.0SMCJ30CA | IFK | 30.00 | 33.30 | 36.80 | 1 | 48.4 | 62.0 | 5 |
| 3.0SMCJ33C | IFL | 33.00 | 36.70 | 44.90 | 1 | 59.0 | 50.4 | 5 |
| 3.0SMCJ33CA | IFM | 33.00 | 36.70 | 40.60 | 1 | 53.3 | 56.2 | 5 |
| 3.0SMCJ36C | IFN | 36.00 | 40.00 | 48.90 | 1 | 64.3 | 46.6 | 5 |
| 3.0SMCJ36CA | IFP | 36.00 | 40.00 | 44.20 | 1 | 58.1 | 51.6 | 5 |
| 3.0SMCJ40C | IFQ | 40.00 | 44.40 | 54.30 | 1 | 71.4 | 42.0 | 5 |
| 3.0SMCJ40CA | IFR | 40.00 | 44.40 | 49.10 | 1 | 64.5 | 46.4 | 5 |
| 3.0SMCJ43C | IFS | 43.00 | 47.80 | 58.40 | 1 | 76.7 | 39.2 | 5 |
| 3.0SMCJ43CA | IFT | 43.00 | 47.80 | 52.80 | 1 | 69.4 | 43.2 | 5 |
| 3.0SMCJ45C | IFU | 45.00 | 50.00 | 61.10 | 1 | 80.3 | 37.4 | 5 |
| 3.0SMCJ45CA | IFV | 45.00 | 50.00 | 55.30 | 1 | 72.7 | 41.2 | 5 |
| 3.0SMCJ48C | IFW | 48.00 | 53.30 | 65.10 | 1 | 85.5 | 35.0 | 5 |
| 3.0SMCJ48CA | IFX | 48.00 | 53.30 | 58.90 | 1 | 77.4 | 38.8 | 5 |
| 3.0SMCJ51C | IFY | 51.00 | 56.70 | 69.30 | 1 | 91.1 | 37.0 | 5 |
| 3.0SMCJ51CA | IFZ | 51.00 | 56.70 | 62.70 | 1 | 82.4 | 36.4 | 5 |
| 3.0SMCJ54C | IGD | 54.00 | 60.00 | 73.30 | 1 | 96.3 | 31.2 | 5 |
| 3.0SMCJ54CA | IGE | 54.00 | 60.00 | 66.30 | 1 | 87.1 | 34.4 | 5 |
| 3.0SMCJ58C | IGF | 58.00 | 64.40 | 78.70 | 1 | 103.0 | 29.2 | 5 |
| 3.0SMCJ58CA | IGG | 58.00 | 64.40 | 71.20 | 1 | 93.6 | 32.0 | 5 |
| 3.0SMCJ60C | IGH | 60.00 | 66.70 | 81.50 | 1 | 107.0 | 28.0 | 5 |
| 3.0SMCJ60CA | IGK | 60.00 | 66.70 | 73.70 | 1 | 96.8 | 31.0 | 5 |
| 3.0SMCJ64C | IGL | 64.00 | 71.10 | 86.90 | 1 | 114.0 | 26.4 | 5 |
| 3.0SMCJ64CA | IGM | 64.00 | 71.10 | 78.60 | 1 | 103.0 | 29.2 | 5 |
| 3.0SMCJ70C | IGN | 70.00 | 77.80 | 95.10 | 1 | 125.0 | 24.0 | 5 |
| 3.0SMCJ70CA | IGP | 70.00 | 77.80 | 86.00 | 1 | 113.0 | 26.6 | 5 |
| 3.0SMCJ75C | IGQ | 75.00 | 83.30 | 102.00 | 1 | 134.0 | 22.4 | 5 |
| 3.0SMCJ75CA | IGR | 75.00 | 83.30 | 92.10 | 1 | 121.0 | 24.8 | 5 |
| 3.0SMCJ78C | IGS | 78.00 | 86.70 | 106.00 | 1 | 139.0 | 21.6 | 5 |
| 3.0SMCJ78CA | IGT | 78.00 | 86.70 | 95.80 | 1 | 126.0 | 22.8 | 5 |
| 3.0SMCJ85C | IGU | 85.00 | 94.40 | 115.00 | 1 | 151.0 | 19.8 | 5 |
| 3.0SMCJ85CA | IGV | 85.00 | 94.40 | 104.00 | 1 | 137.0 | 20.8 | 5 |
| 3.0SMCJ90C | IGW | 90.00 | 100.00 | 122.00 | 1 | 160.0 | 18.8 | 5 |
| 3.0SMCJ90CA | IGX | 90.00 | 100.00 | 111.00 | 1 | 146.0 | 20.6 | 5 |
| 3.0SMCJ100C | IGY | 100.00 | 111.00 | 136.00 | 1 | 179.0 | 16.6 | 5 |
| 3.0SMCJ100CA | IGZ | 100.00 | 111.00 | 123.00 | 1 | 162.0 | 18.6 | 5 |
| 3.0SMCJ110C | IHD | 110.00 | 122.00 | 149.00 | 1 | 196.0 | 15.4 | 5 |
| 3.0SMCJ110CA | IHE | 110.00 | 122.00 | 135.00 | 1 | 177.0 | 16.8 | 5 |
| 3.0SMCJ120C | IHF | 120.00 | 133.00 | 163.00 | 1 | 214.0 | 14.0 | 5 |
| 3.0SMCJ120CA | IHG | 120.00 | 133.00 | 147.00 | 1 | 193.0 | 15.6 | 5 |
| 3.0SMCJ130C | IHH | 130.00 | 144.00 | 176.00 | 1 | 231.0 | 13.0 | 5 |
| 3.0SMCJ130CA | IHK | 130.00 | 144.00 | 159.00 | 1 | 209.0 | 14.4 | 5 |
| 3.0SMCJ150C | IHL | 150.00 | 167.00 | 204.00 | 1 | 268.0 | 11.2 | 5 |
| 3.0SMCJ150CA | IHM | 150.00 | 167.00 | 185.00 | 1 | 243.0 | 12.4 | 5 |
| 3.0SMCJ160C | IHN | 160.00 | 178.00 | 218.00 | 1 | 287.0 | 10.4 | 5 |
| 3.0SMCJ160CA | IHP | 160.00 | 178.00 | 197.00 | 1 | 259.0 | 11.6 | 5 |
| 3.0SMCJ170C | IHQ | 170.00 | 189.00 | 231.00 | 1 | 304.0 | 9.8 | 5 |
| 3.0SMCJ170CA | IHR | 170.00 | 189.00 | 209.00 | 1 | 275.0 | 11.0 | 5 |

MARKING INFORMATION



Cathode = Polarity Band Except Bi-Directional Types
 WTE = Manufacturer's Logo
 xxx = Device Code, See Page 3 & 4

RECOMMENDED FOOTPRINT

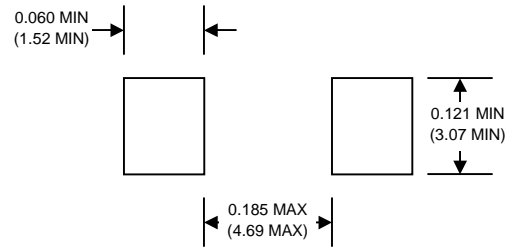

inches(mm)

PACKAGING INFORMATION

TAPE & REEL

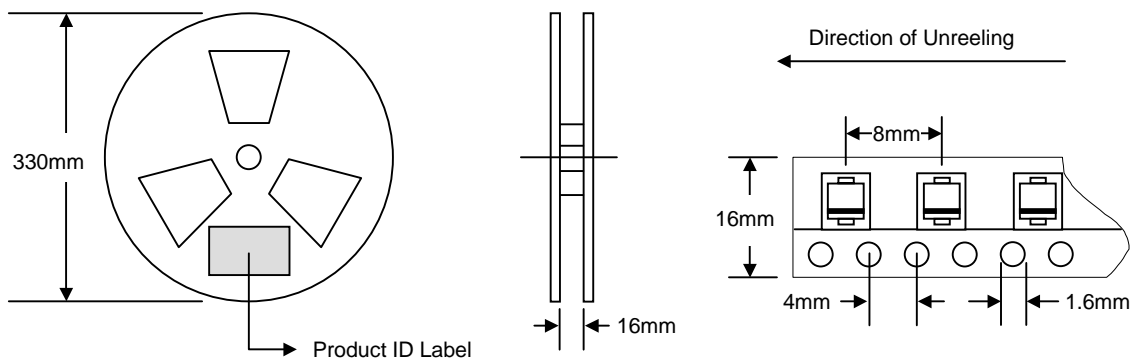

| Reel Diameter (mm) | Quantity (PCS) | Inner Box Size L x W x H (mm) | Quantity (PCS) | Carton Size L x W x H (mm) | Quantity (PCS) | Approx. Gross Weight (KG) |
|--------------------|----------------|-------------------------------|----------------|----------------------------|----------------|---------------------------|
| 330 | 3,000 | 340 x 337 x 45 | 6,000 | 370 x 370 x 420 | 48,000 | 19.0 |

Note: 1. Paper reel, white or gray color.
 2. Components are packed in accordance with EIA standard 481-1 and 481-2.

ORDERING INFORMATION

| Product No. | Package Type | Shipping Quantity |
|--------------|--------------|-------------------|
| 3.0SMCJxx-T3 | SMC | 3000/Tape & Reel |

1. Shipping quantity given is for minimum packing quantity only. For minimum order quantity, please consult the Sales Department.
2. **To order RoHS / Lead Free version, add "-LF" suffix to part number above. For example, 3.0SMCJ5.0-T3-LF.**

Won-Top Electronics Co., Ltd (WTE) has checked all information carefully and believes it to be correct and accurate. However, WTE cannot assume any responsibility for inaccuracies. Furthermore, this information does not give the purchaser of semiconductor devices any license under patent rights to manufacturer. WTE reserves the right to change any or all information herein without further notice.

WARNING: DO NOT USE IN LIFE SUPPORT EQUIPMENT. WTE power semiconductor products are not authorized for use as critical components in life support devices or systems without the express written approval.

Won-Top Electronics Co., Ltd.

No. 44 Yu Kang North 3rd Road, Chine Chen Dist., Kaohsiung, Taiwan

Phone: 886-7-822-5408 or 886-7-822-5410

Fax: 886-7-822-5417

Email: sales@wontop.com

Internet: <http://www.wontop.com>

We power your everyday.