LOW VOLTAGE DETECTOR WITH OUTPUT DELAY

NO. EA-087-120423

OUTLINE

The R3112x Series are CMOS-based voltage detector ICs with high detector threshold accuracy and ultra-low supply current, which can be operated at an extremely low voltage and is used for system reset as an example.

Each of these ICs consists of a voltage reference unit, a comparator, resistor net for detector threshold setting, an output driver, a hysteresis circuit, and an output delay circuit. The detector threshold is fixed with high accuracy internally and does not require any adjustment. Two output types, Nch open drain type and CMOS type are available.

Three types of packages, SOT-23-5, small SC-82AB, SC-88A and ultra-small SON1612-6 can be selected so that high density mounting on boards is possible.

FEATURES

- Built-in Output Delay Circuit..... Typ. 100ms with an external capacitor: 0.022 μ F
- Supply Current..... Typ. 0.5 μ A (R3112x27xA/C, V_{DD}=2.6V)
- Operating Voltage 0.7 to 6.0V (T_{opt}=25°C)
- Detector Threshold..... 0.9V to 5.0V (0.1V steps)
- Detector Threshold Accuracy..... \pm 2.0%
- Temperature-Drift Coefficient of Detector Threshold Typ. \pm 100ppm/°C
- Output Types..... Nch Open Drain and CMOS
- Packages SON1612-6, SC-82AB, SC-88A, SOT-23-5

APPLICATIONS

- CPU and Logic Circuit Reset
- Battery Checker
- Window Comparator
- Wave Shaping Circuit
- Battery Back-up Circuit
- Power Failure Detector

BLOCK DIAGRAMS

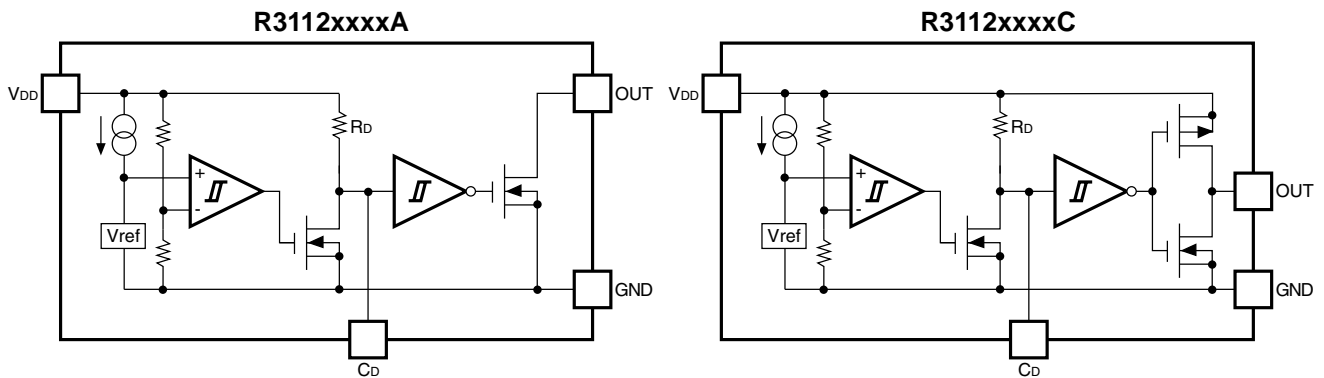

SELECTION GUIDE

The package type, the detector threshold, and the output type for the ICs can be selected at the users' request.

Product Name	Package	Quantity per Reel	Pb Free	Halogen Free
R3112Dxx1*-TR-FE	SON1612-6	4,000 pcs	Yes	Yes
R3112Qxx1*-TR-FE	SC-82AB	3,000 pcs	Yes	Yes
R3112Qxx2*-TR-FE	SC-88A	3,000 pcs	Yes	Yes
R3112Nxx1*-TR-FE	SOT-23-5	3,000 pcs	Yes	Yes

xx: The detector threshold can be designated in the range from 0.9V(09) to 5.0V(50) in 0.1V steps.

* : Designation of Output Type
 (A) Nch Open Drain
 (C) CMOS

PIN CONFIGURATION

● SON1612-6

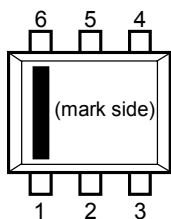

● SC-82AB

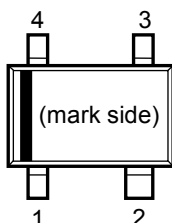

● SC-88A

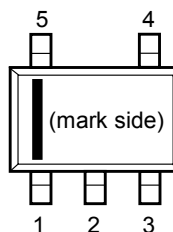

● SOT-23-5

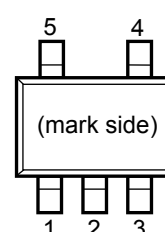

PIN DESCRIPTION

● SON1612-6

Pin No	Symbol	Pin Description
1	OUT	Output Pin (Output "L" at detection)
2	GND	Ground Pin
3	C _D	Pin for External Capacitor (for setting output delay)
4	NC	No Connection
5	GND	Ground Pin
6	V _{DD}	Voltage Supply Pin

● SC-82AB

Pin No	Symbol	Pin Description
1	V _{DD}	Voltage Supply Pin
2	GND	Ground Pin
3	C _D	Pin for External Capacitor (for setting output delay)
4	OUT	Output Pin (Output "L" at detection)

● SC-88A

Pin No	Symbol	Pin Description
1	V _{DD}	Voltage Supply Pin
2	NC	No Connection
3	GND	Ground Pin
4	C _D	Pin for External Capacitor (for setting output delay)
5	OUT	Output Pin (Output "L" at detection)

● SOT-23-5

Pin No	Symbol	Pin Description
1	OUT	Output Pin (Output "L" at detection)
2	V _{DD}	Voltage Supply Pin
3	GND	Ground Pin
4	NC	No Connection
5	C _D	Pin for External Capacitor (for setting output delay)

ABSOLUTE MAXIMUM RATINGS

Symbol	Item	Rating	Unit
V_{DD}	Supply Voltage	6.5	V
V_{OUT}	Output Voltage (CMOS)	$V_{SS}-0.3$ to $V_{DD}+0.3$	V
	Output Voltage (Nch)	$V_{SS}-0.3$ to 6.5	V
I_{OUT}	Output Current	20	mA
P_D	Power Dissipation (SON1612-6)*	500	mW
	Power Dissipation (SC-82AB)*	380	
	Power Dissipation (SC-88A)*	380	
	Power Dissipation (SOT-23-5)*	420	
T_{opt}	Operating Temperature Range	-40 to 85	°C
T_{stg}	Storage Temperature Range	-55 to 125	°C

*) For Power Dissipation, please refer to PACKAGE INFORMATION.

ABSOLUTE MAXIMUM RATINGS

Electronic and mechanical stress momentarily exceeded absolute maximum ratings may cause the permanent damages and may degrade the life time and safety for both device and system using the device in the field.

The functional operation at or over these absolute maximum ratings is not assured.

RECOMMENDED OPERATING CONDITIONS (ELECTRICAL CHARACTERISTICS)

All of electronic equipment should be designed that the mounted semiconductor devices operate within the recommended operating conditions. The semiconductor devices cannot operate normally over the recommended operating conditions, even if when they are used over such conditions by momentary electronic noise or surge. And the semiconductor devices may receive serious damage when they continue to operate over the recommended operating conditions.

ELECTRICAL CHARACTERISTICS

• R3112xxxxA/C

T_{opt}=25°C

Symbol	Item	Conditions		Min.	Typ.	Max.	Unit
-V _{DET}	Detector Threshold			-V _{DET} ×0.98		-V _{DET} ×1.02	V
V _{HYS}	Detector Threshold Hysteresis			-V _{DET} ×0.03	-V _{DET} ×0.05	-V _{DET} ×0.07	V
I _{SS}	Supply Current	-V _{DET} <1.1V	V _{DD} =-V _{DET} -0.1V		0.6	2.0	μA
			V _{DD} =-V _{DET} +1.0V		0.5	2.0	
		1.1V ≤ -V _{DET} <1.6V	V _{DD} =-V _{DET} -0.1V		0.7	2.5	
			V _{DD} =-V _{DET} +1.0V		0.5	2.0	
		1.6V ≤ -V _{DET} <3.1V	V _{DD} =-V _{DET} -0.1V		1.0	3.0	
			V _{DD} =-V _{DET} +1.0V		0.5	2.5	
		3.1V ≤ -V _{DET} <4.1V	V _{DD} =-V _{DET} -0.1V		1.2	3.0	
			V _{DD} =-V _{DET} +1.0V		0.6	2.5	
4.1V ≤ -V _{DET}	V _{DD} =-V _{DET} -0.1V		1.5	3.0			
	V _{DD} =-V _{DET} +1.0V		0.6	2.5			
V _{DDH}	Maximum Operating Voltage					6.0	V
V _{DDL}	Minimum Operating Voltage*	T _{opt} =25°C				0.7	V
		-40°C ≤ T _{opt} ≤ 85°C				0.8	
I _{OUT}	Output Current (Driver Output Pin)	Nch	V _{DS} =0.05V V _{DD} =0.7V		0.01	0.12	mA
			-V _{DET} <1.1V	V _{DS} =0.50V V _{DD} =0.85V	0.05	0.9	
			1.1V ≤ -V _{DET} <1.6V	V _{DS} =0.50V V _{DD} =1.00V	0.2	1.8	
		1.6V ≤ -V _{DET}	V _{DS} =0.50V V _{DD} =1.50V	1.0	3.0		
		Pch	-V _{DET} <4.0V	V _{DS} =-2.1V V _{DD} =4.50V	1.5	3.5	mA
			4.0V ≤ -V _{DET}	V _{DS} =-2.1V V _{DD} =6.00V	2.0	4.5	
V _{TCD}	C _D pin Threshold Voltage	V _{DD} =-V _{DET} ×1.1V		V _{DD} ×0.3	V _{DD} ×0.5	V _{DD} ×0.7	V
I _{CD}	C _D pin Output Current	V _{DS} =0.1V, V _{DD} =0.7V		20	70	μA	
		-V _{DET} <1.1V	V _{DS} =0.50V, V _{DD} =0.85V	10	400		
		1.1V ≤ -V _{DET} <1.6V	V _{DS} =0.50V, V _{DD} =1.00V	50	450		
		1.6V ≤ -V _{DET}	V _{DS} =0.50V, V _{DD} =1.50V	200	500		
R _D	Output Delay Resistance			3.25	6.5	13	MΩ
Δ-V _{DET} / ΔT _{opt}	Detector Threshold Temperature Coefficient	-40°C ≤ T _{opt} ≤ 85°C			±100		ppm/ °C

*) Minimum Operating Voltage means the value of input voltage when output voltage maintains 0.1V or less.
(In the case of Nch Open Drain Type, Output pin is pulled up with a resistance of 470kΩ to 5.0V.)

ELECTRICAL CHARACTERISTICS BY DETECTOR THRESHOLD

Product Code	Detector Threshold			Hysteresis Range			Supply Current 1			Supply Current 2			Output Current 1			Output Current 2			
	-VDET[V]			VHYS[V]			Iss1[μA]			Iss2[μA]			Iout1[mA]			Iout2[mA]			
	Min.	Typ.	Max.	Min.	Typ.	Max.	Conditions	Typ.	Max.	Conditions	Typ.	Max.	Conditions	Min.	Typ.	Conditions	Min.	Typ.	
R3112x09xA/C	0.882	0.900	0.918	0.027	0.045	0.063	VDD=-VDET -0.1V	0.6	2.0	VDD=-VDET +1.0V	0.5	2.0	VDS=0.05V VDD=0.7V	0.01	0.12	Nch	VDS=0.5V VDD=0.85V	0.05	0.9
R3112x10xA/C	0.980	1.000	1.020	0.030	0.050	0.070													
R3112x11xA/C	1.078	1.100	1.122	0.033	0.055	0.077													
R3112x12xA/C	1.176	1.200	1.224	0.036	0.060	0.084													
R3112x13xA/C	1.274	1.300	1.326	0.039	0.065	0.091													
R3112x14xA/C	1.372	1.400	1.428	0.042	0.070	0.098													
R3112x15xA/C	1.470	1.500	1.530	0.045	0.075	0.105													
R3112x16xA/C	1.568	1.600	1.632	0.048	0.080	0.112													
R3112x17xA/C	1.666	1.700	1.734	0.051	0.085	0.119													
R3112x18xA/C	1.764	1.800	1.836	0.054	0.090	0.126													
R3112x19xA/C	1.862	1.900	1.938	0.057	0.095	0.133													
R3112x20xA/C	1.960	2.000	2.040	0.060	0.100	0.140													
R3112x21xA/C	2.058	2.100	2.142	0.063	0.105	0.147													
R3112x22xA/C	2.156	2.200	2.244	0.066	0.110	0.154													
R3112x23xA/C	2.254	2.300	2.346	0.069	0.115	0.161													
R3112x24xA/C	2.352	2.400	2.448	0.072	0.120	0.168													
R3112x25xA/C	2.450	2.500	2.550	0.075	0.125	0.175													
R3112x26xA/C	2.548	2.600	2.652	0.078	0.130	0.182													
R3112x27xA/C	2.646	2.700	2.754	0.081	0.135	0.189													
R3112x28xA/C	2.744	2.800	2.856	0.084	0.140	0.196													
R3112x29xA/C	2.842	2.900	2.958	0.087	0.145	0.203													
R3112x30xA/C	2.940	3.000	3.060	0.090	0.150	0.210													
R3112x31xA/C	3.038	3.100	3.162	0.093	0.155	0.217													
R3112x32xA/C	3.136	3.200	3.264	0.096	0.160	0.224													
R3112x33xA/C	3.234	3.300	3.366	0.099	0.165	0.231													
R3112x34xA/C	3.332	3.400	3.468	0.102	0.170	0.238													
R3112x35xA/C	3.430	3.500	3.570	0.105	0.175	0.245													
R3112x36xA/C	3.528	3.600	3.672	0.108	0.180	0.252													
R3112x37xA/C	3.626	3.700	3.774	0.111	0.185	0.259													
R3112x38xA/C	3.724	3.800	3.876	0.114	0.190	0.266													
R3112x39xA/C	3.822	3.900	3.978	0.117	0.195	0.273													
R3112x40xA/C	3.920	4.000	4.080	0.120	0.200	0.280													
R3112x41xA/C	4.018	4.100	4.182	0.123	0.205	0.287													
R3112x42xA/C	4.116	4.200	4.284	0.126	0.210	0.294													
R3112x43xA/C	4.214	4.300	4.386	0.129	0.215	0.301													
R3112x44xA/C	4.312	4.400	4.488	0.132	0.220	0.308													
R3112x45xA/C	4.410	4.500	4.590	0.135	0.225	0.315													
R3112x46xA/C	4.508	4.600	4.692	0.138	0.230	0.322													
R3112x47xA/C	4.606	4.700	4.794	0.141	0.235	0.329													
R3112x48xA/C	4.704	4.800	4.896	0.144	0.240	0.336													
R3112x49xA/C	4.802	4.900	4.998	0.147	0.245	0.343													
R3112x50xA/C	4.900	5.000	5.100	0.150	0.250	0.350													

Output Current 3			Minimum Operating Voltage				Cd pin Threshold Voltage			Cd pin Output Current 1			Cd pin Output Current 2			Resistance for Output Delay			Detector Threshold Temperature		
I _{OUT3} [mA]			V _{DDL} [V]				V _{TCD} [V]			I _{CD1} [μA]			I _{CD2} [μA]			R _D [MΩ]			Δ-V _{DET} / ΔT _{opt} [ppm/°C]		
Condition	Min.	Typ.	Condition	Max.	Condition	Max.	Condition	Min.	Typ.	Max.	Condition	Min.	Typ.	Condition	Min.	Typ.	Min.	Typ.	Max.	Condition	Typ.
Pch	V _{DS} = -2.1V V _{DD} = 4.5V	1.5	3.5	0.7	-40°C ≧ T _{opt} ≦ 85°C	0.8	V _{DD} = (-V _{DET}) ×1.1V	0.297	0.495	0.693	V _{DS} = 0.1V V _{DD} = 0.7V	20	70	V _{DS} = 0.5V V _{DD} = 0.85V	10	400	3.25	6.5	13.0	-40°C ≧ T _{opt} ≦ 85°C	±100
								0.330	0.550	0.770											
								0.363	0.605	0.847				V _{DS} = 0.5V V _{DD} = 1.0V	50	450					
								0.396	0.660	0.924											
								0.429	0.715	1.001											
								0.462	0.770	1.078											
								0.495	0.825	1.155											
								0.528	0.880	1.232											
								0.561	0.935	1.309											
								0.594	0.990	1.386											
								0.627	1.045	1.463											
								0.660	1.100	1.540											
								0.693	1.155	1.617											
								0.726	1.210	1.694											
								0.759	1.265	1.771											
								0.792	1.320	1.848											
								0.825	1.375	1.925											
								0.858	1.430	2.002											
								0.891	1.485	2.079											
								0.924	1.540	2.156											
								0.957	1.595	2.233											
								0.990	1.650	2.310											
								1.023	1.705	2.387											
								1.056	1.760	2.464				V _{DS} = 0.5V V _{DD} = 1.5V	200	500					
								1.089	1.815	2.541											
								1.122	1.870	2.618											
								1.155	1.925	2.695											
								1.188	1.980	2.772											
								1.221	2.035	2.849											
								1.254	2.090	2.926											
								1.287	2.145	3.003											
								1.320	2.200	3.080											
								1.353	2.255	3.157											
								1.386	2.310	3.234											
								1.419	2.365	3.311											
								1.452	2.420	3.388											
								1.485	2.475	3.465											
								1.518	2.530	3.542											
								1.551	2.585	3.619											
								1.584	2.640	3.696											
								1.617	2.695	3.773											
								1.650	2.750	3.850											

OPERATION

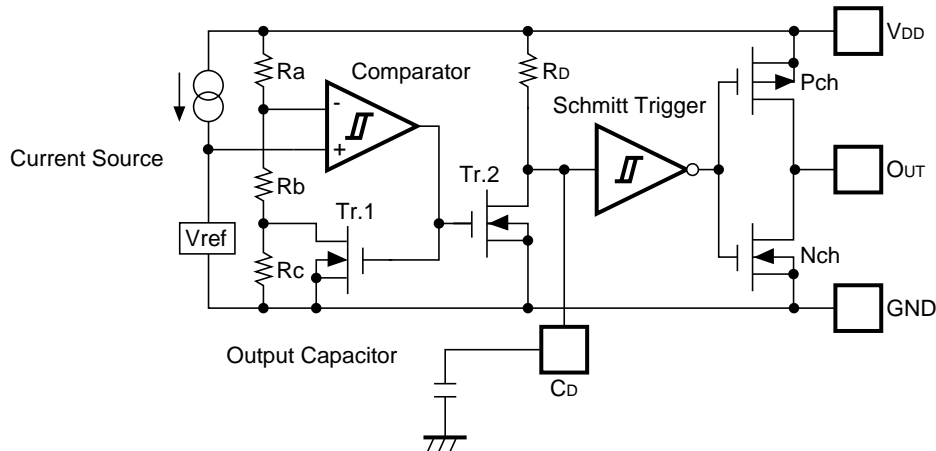

Fig. 1 Block Diagram with an external capacitor

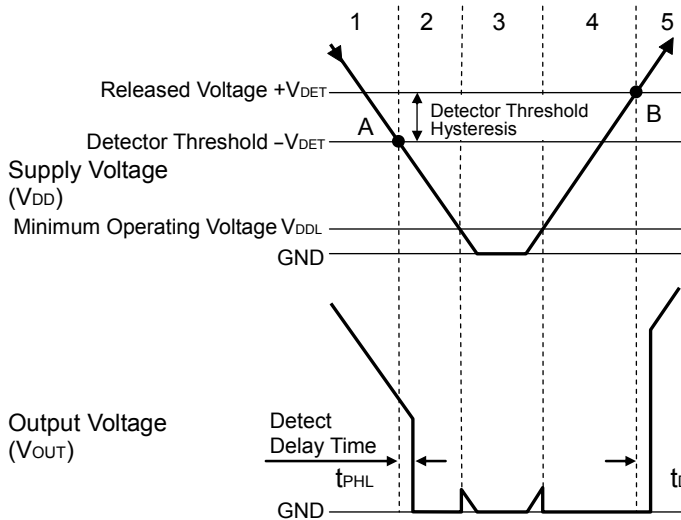

Fig. 2 Operation Diagram

Step	1	2	3	4	5
Comparator (-) Pin Input Voltage	I	II	II	II	I
Comparator Output	L	H	Indefinite	H	L
Tr.1,2	OFF	ON	Indefinite	ON	OFF
Output Tr.	Pch	ON	OFF	Indefinite	OFF
	Nch	OFF	ON	Indefinite	ON

$$I \quad \frac{Rb+Rc}{Ra+Rb+Rc} \times V_{DD}$$

$$II \quad \frac{Rb}{Ra+Rb} \times V_{DD}$$

1. Output voltage is equal to supply voltage. (As for Nch open drain type, equal to pull-up voltage.)
 2. When the supply voltage is down to the detector threshold voltage level(Point A), $V_{ref} \geq V_{DD} \times (Rb+Rc)/(Ra+Rb+Rc)$ is true, then output of the comparator is reversed from "L" to "H", therefore output voltage becomes GND level.
 3. When the supply voltage is lower than minimum operating voltage, the operation of output transistor is indefinite. In the case of Nch open drain type, output voltage is equal to pull-up voltage.
 4. Output Voltage becomes GND level.
 5. When the supply voltage is higher than released voltage (Point B), $V_{ref} \leq V_{DD} \times Rb/(Ra+Rb)$ is true, then output of the comparator reaches the threshold level, and Output of Shmitt Trigger is reversed from "H" to "L", then output voltage is equal to supply voltage. (As for Nch open drain type, equal to pull-up voltage.)
- *) The difference between released voltage and detector threshold voltage means hysteresis range voltage.

• Operation of Output Delay

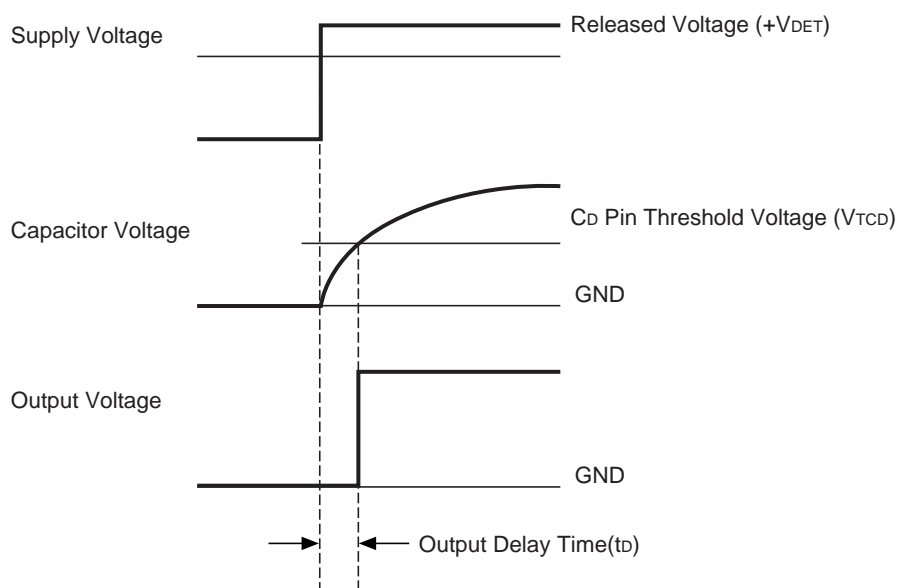

When the supply voltage which is higher than released voltage is forced to V_{DD} pin, charge to an external capacitor starts, then capacitor voltage increases. Until the capacitor voltage reaches to C_D pin threshold voltage, output voltage maintains "L". When the capacitor voltage becomes higher than C_D pin threshold voltage, output voltage is reversed from "L" to "H". Where, the time interval between the rising edge of supply voltage and output voltage reverse point means output delay time.

• Output Delay Time

Output Delay Time (t_D) can be calculated with the next formula.

$$t_D = 0.69 \times R_D \times C_D (\text{s})$$

R_D is internal resistor and set at $6.5\text{M}\Omega$ (Typ.) typically. C_D (F) describes the capacitance value of an external capacitor. Therefore,

$$t_D = 0.69 \times 6.5 \times 10^6 \times C_D (\text{s})$$

TEST CIRCUITS

*Pull-up circuit is not necessary for CMOS Output type, or R3112xxxxC.

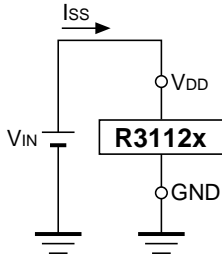

Supply Current Test Circuit

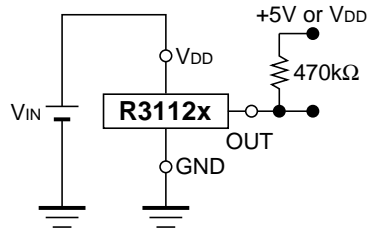

Detector Threshold Test Circuit

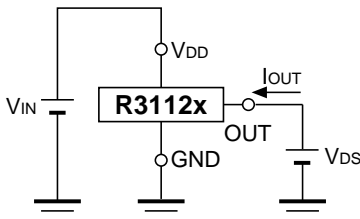

Nch Driver Output Current Test Circuit

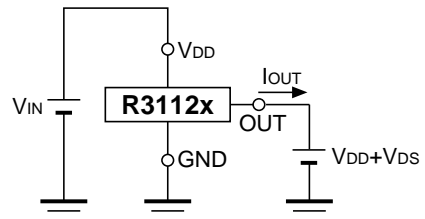

Pch Driver Output Current Test Circuit

*Apply only to CMOS

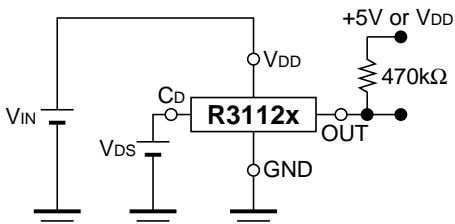

CD Pin Threshold Test Circuit

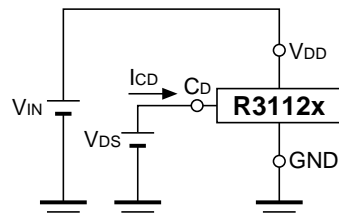

CD Pin Output Current Test Circuit

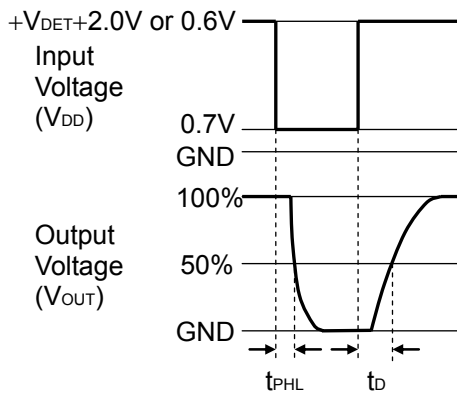

Output Delay Time Test Circuit

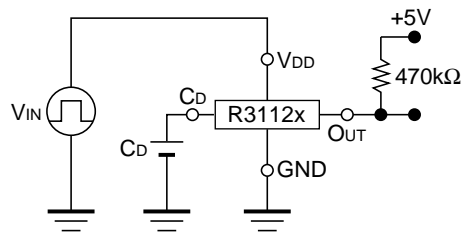

TYPICAL CHARACTERISTICS

1) Supply Current vs. Input Voltage

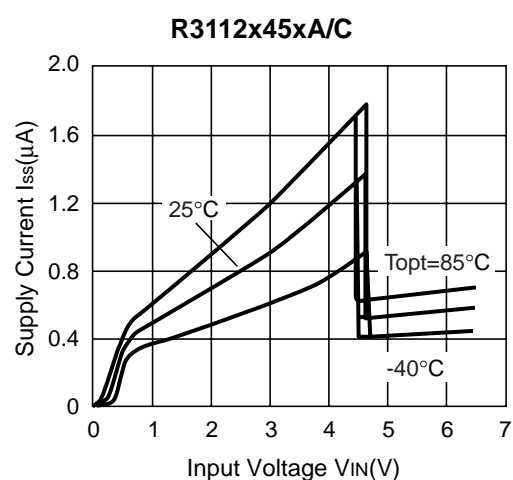
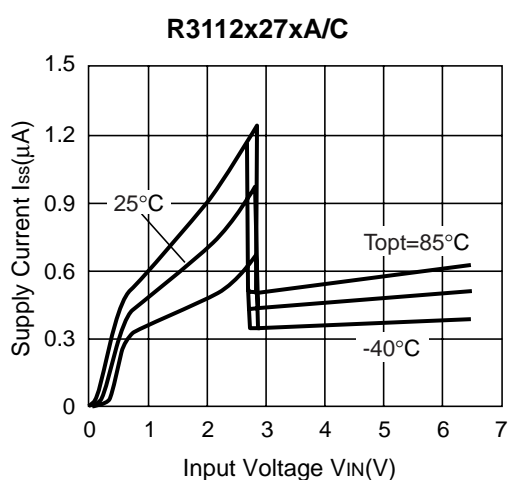
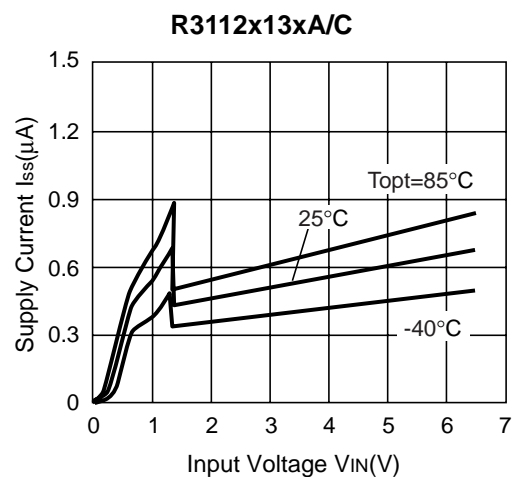
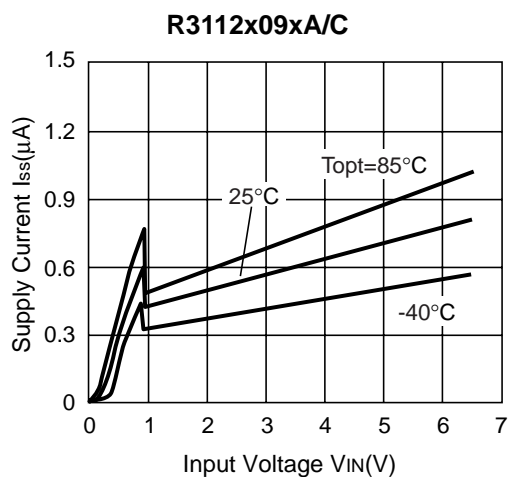

2) Detector Threshold vs. Temperature

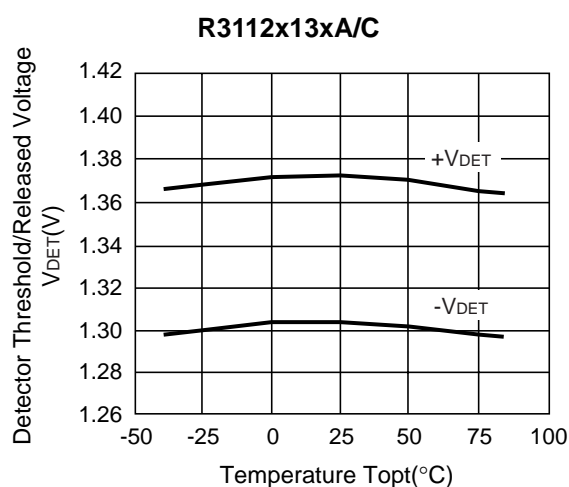
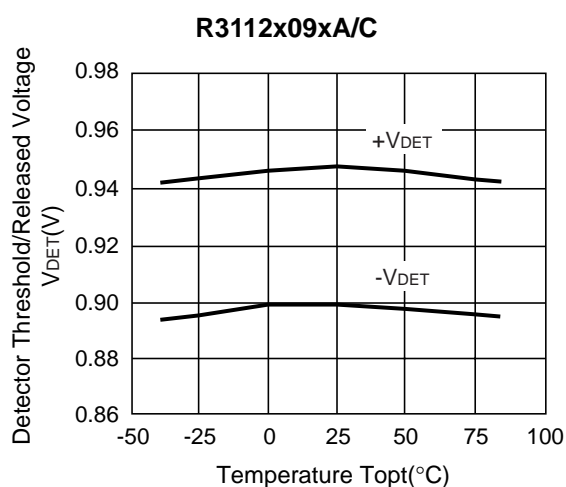

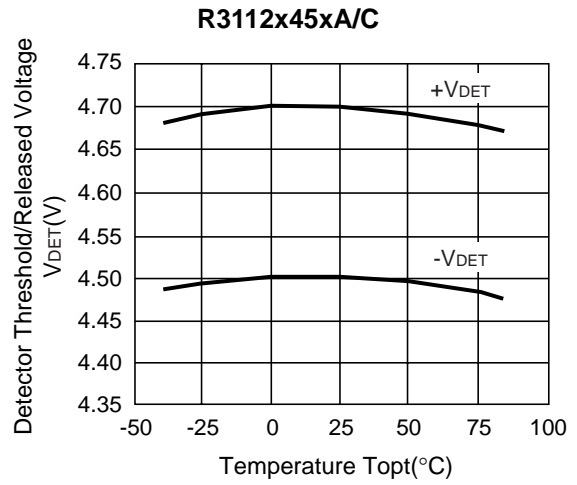
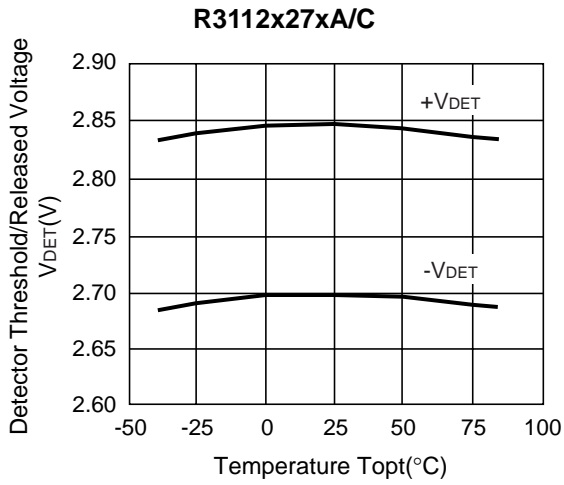

3) Output Voltage vs. Input Voltage

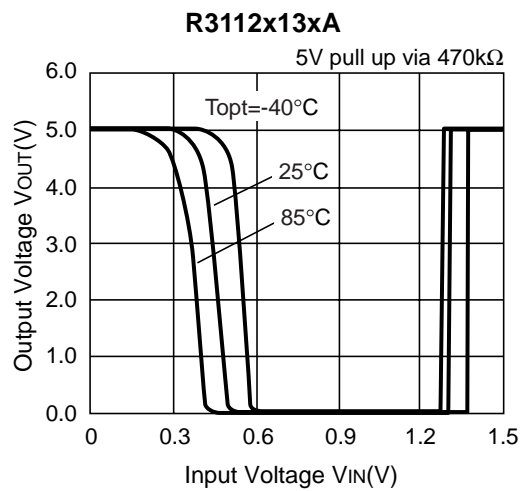
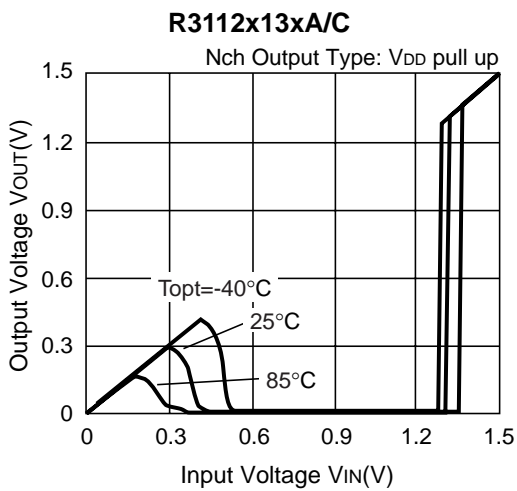
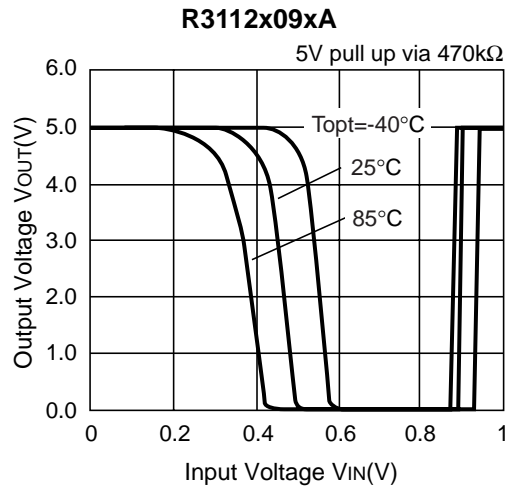
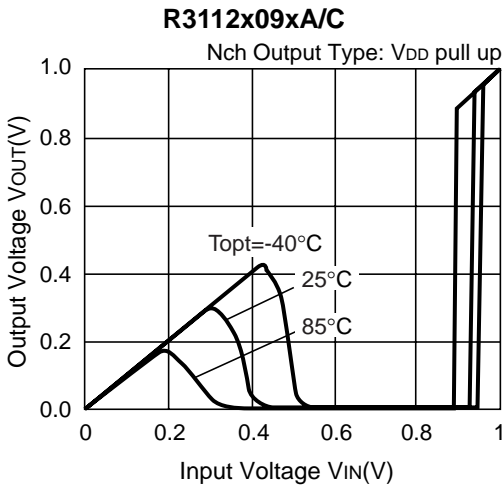

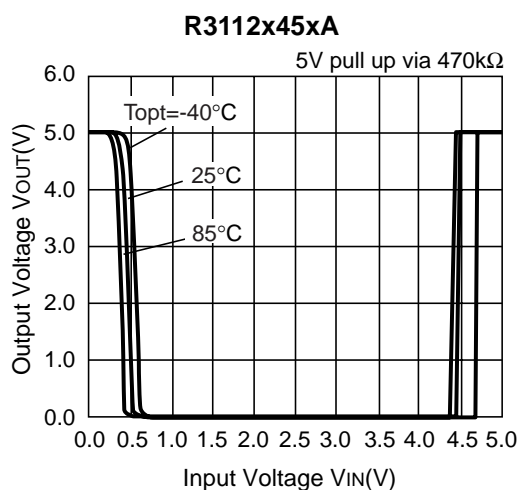
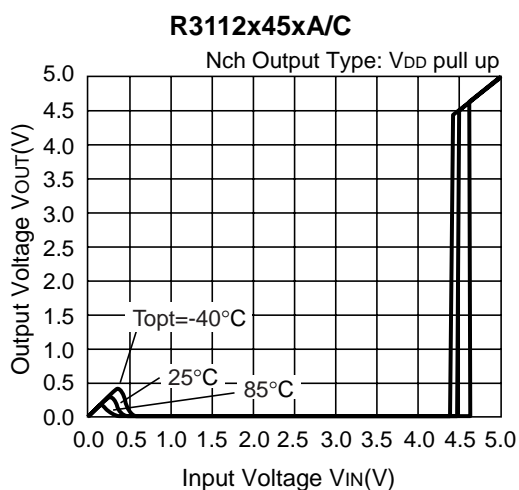
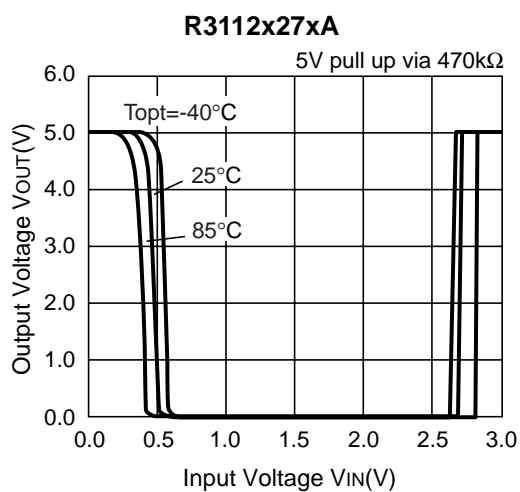
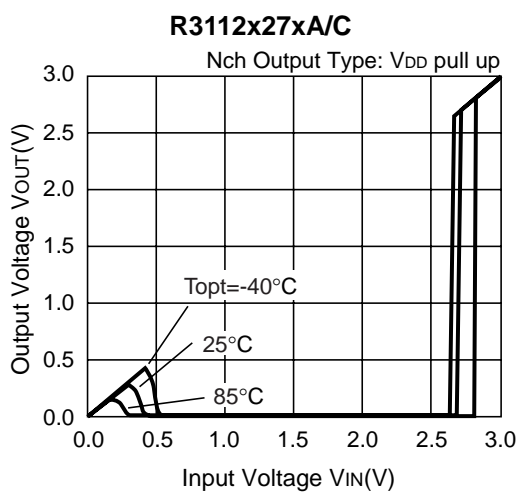

4) Nch Driver Output Current vs. V_{DS}

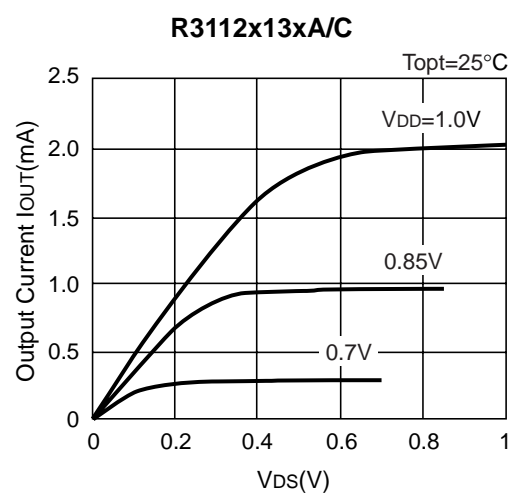
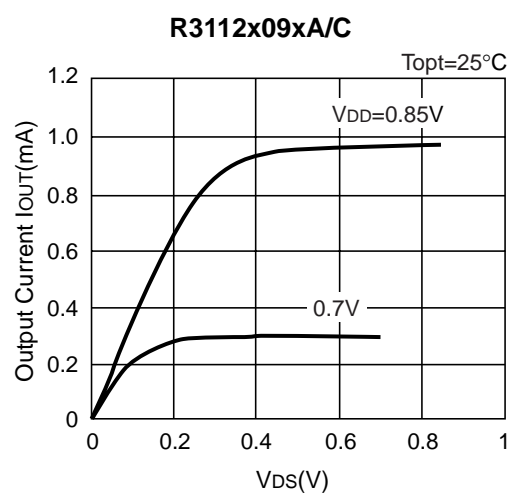

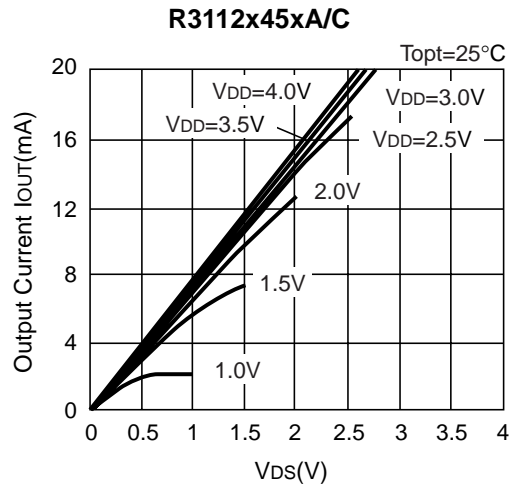
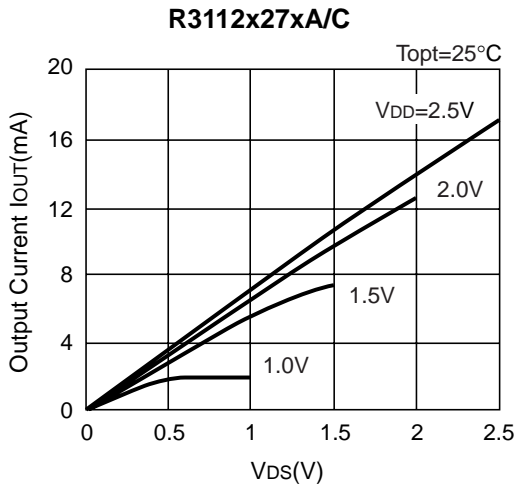

5) Nch Driver Output Current vs. Input Voltage

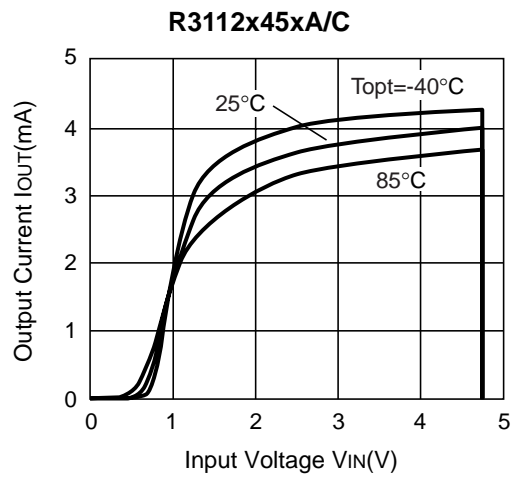
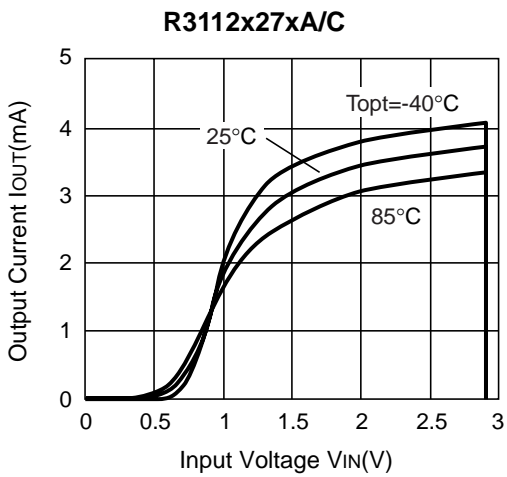
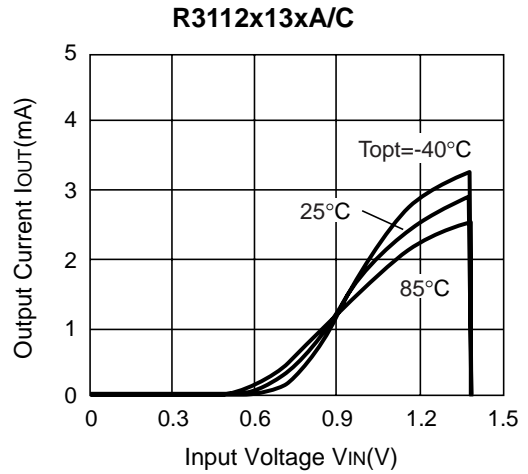
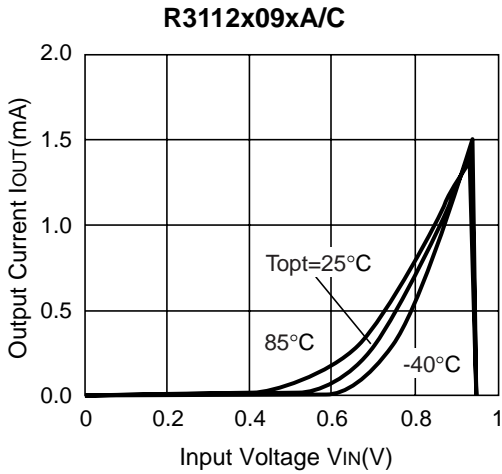

6) Pch Driver Output Current vs. Input Voltage

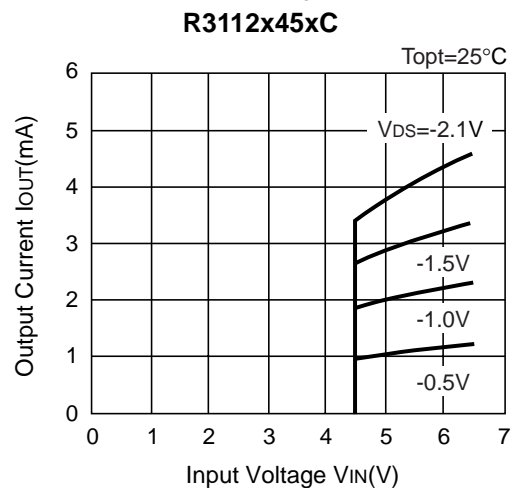
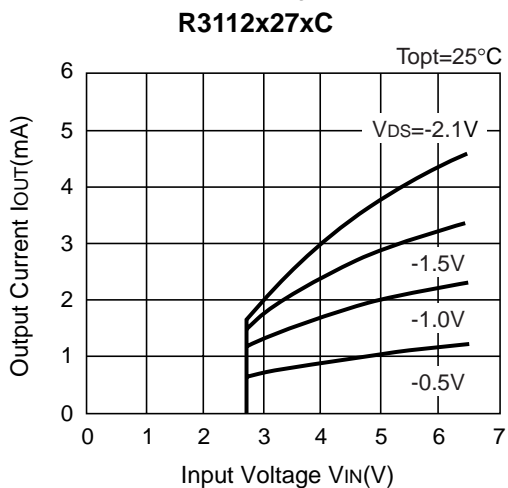
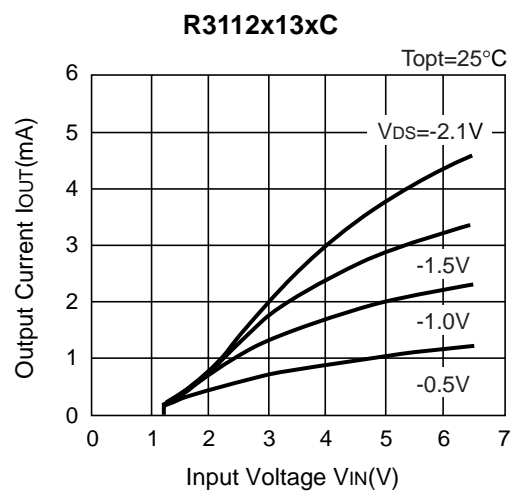
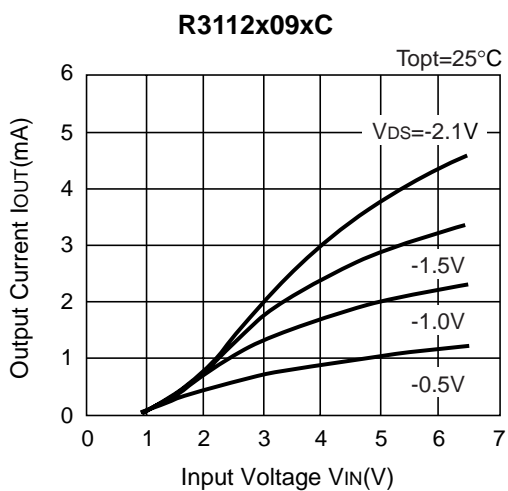

7) C_D Pin Threshold Voltage vs. Temperature

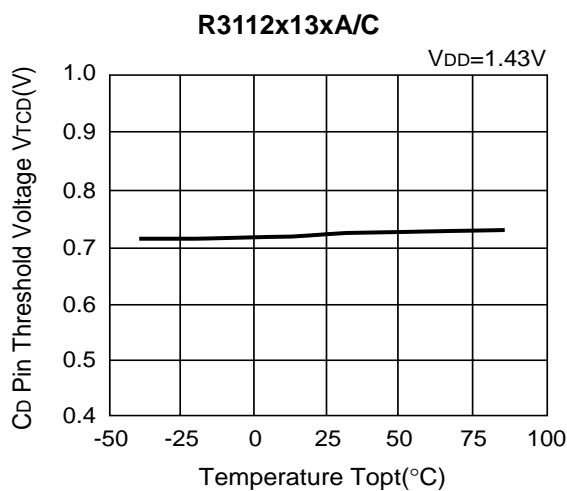
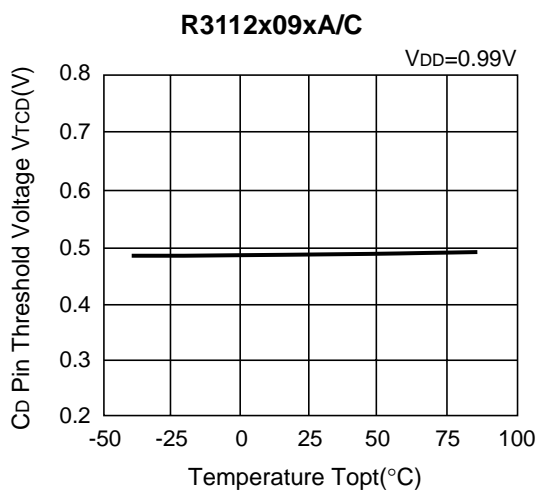

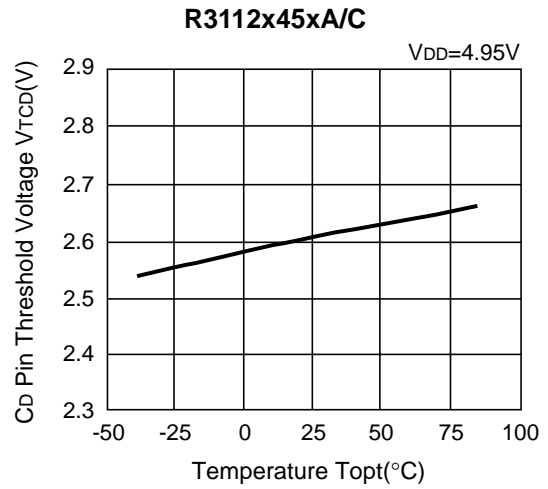
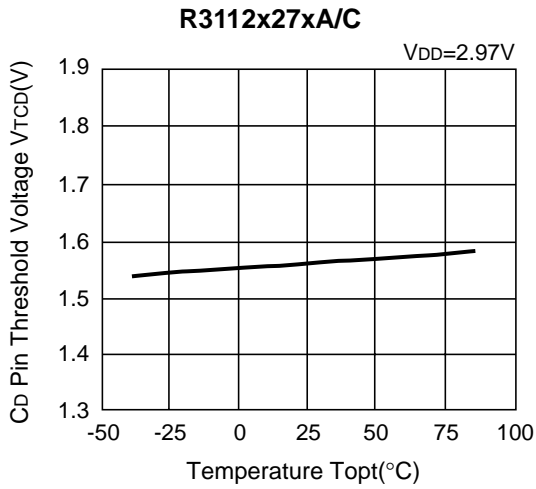

8) C_D Pin Output Current vs. Input Voltage

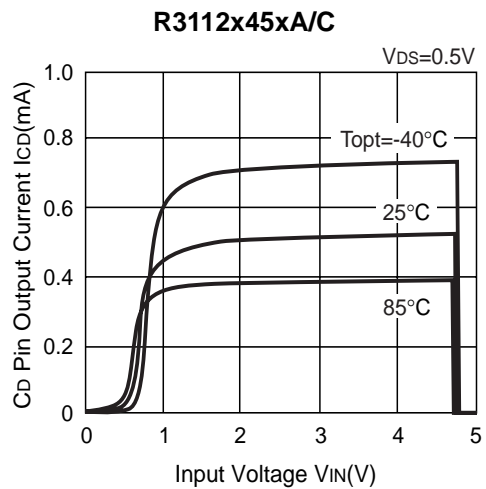
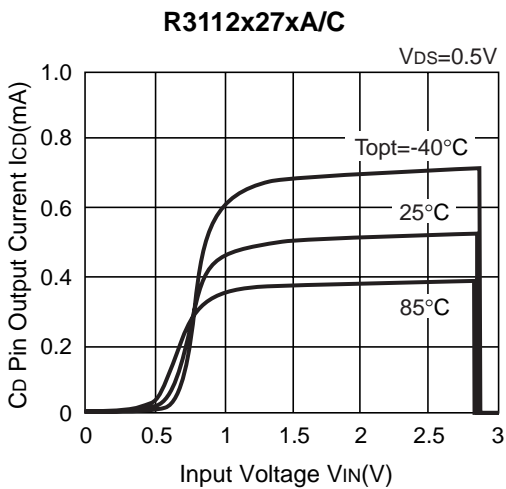
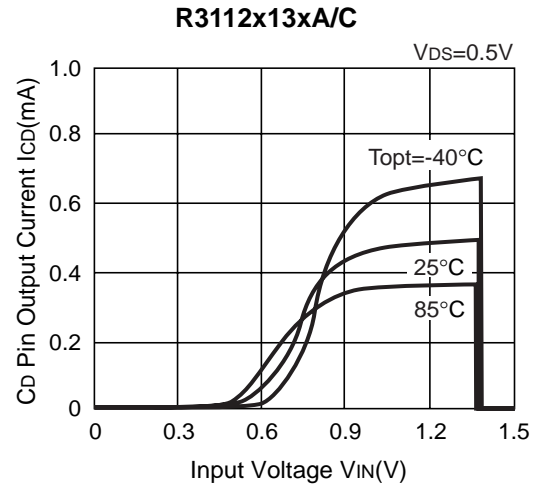
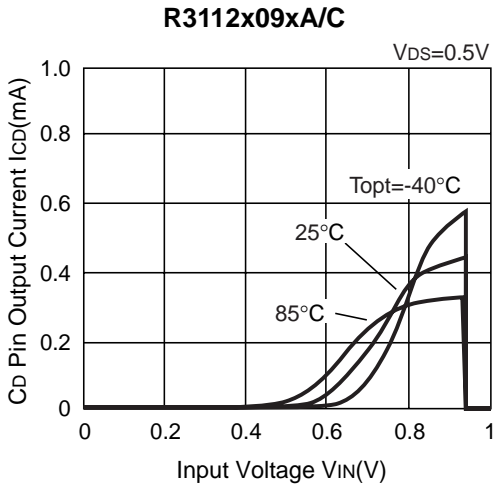

9) C_D Pin Output Current vs. V_{DS} ($T_{opt}=25^\circ C$)

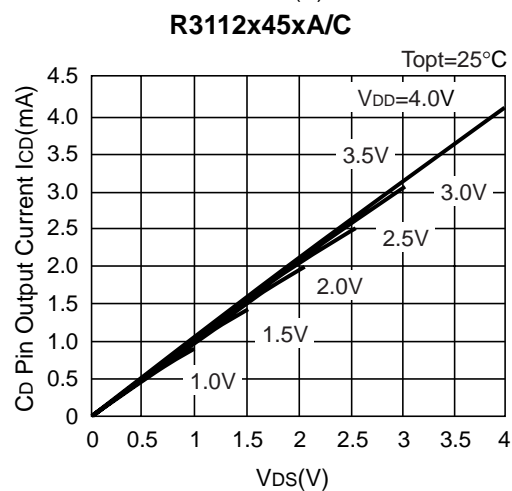
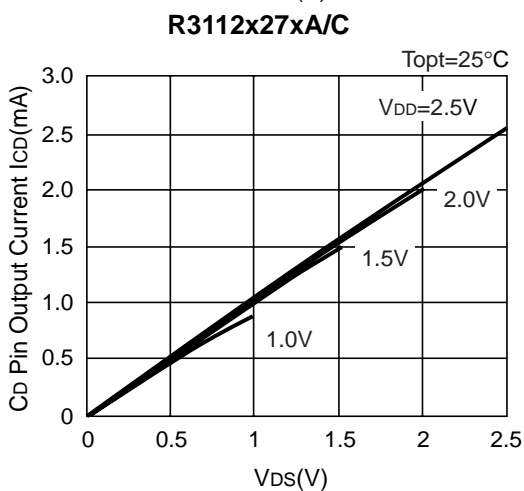
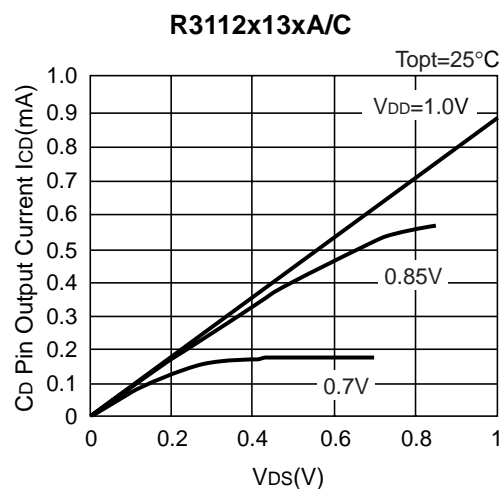
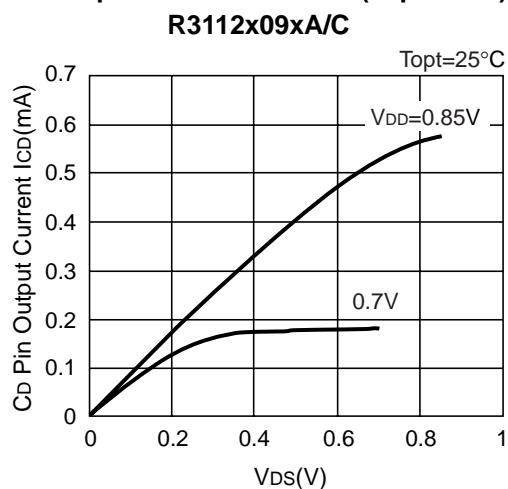

10) Output Delay Time vs. External Capacitance ($T_{opt}=25^\circ C$)

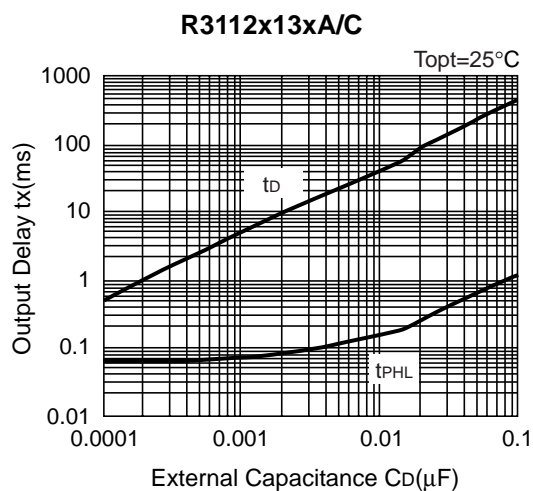
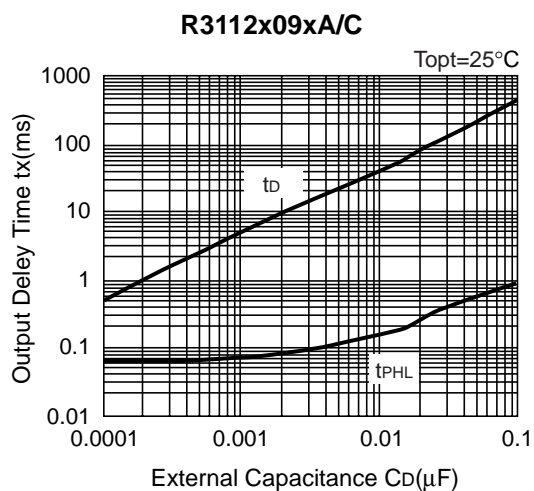

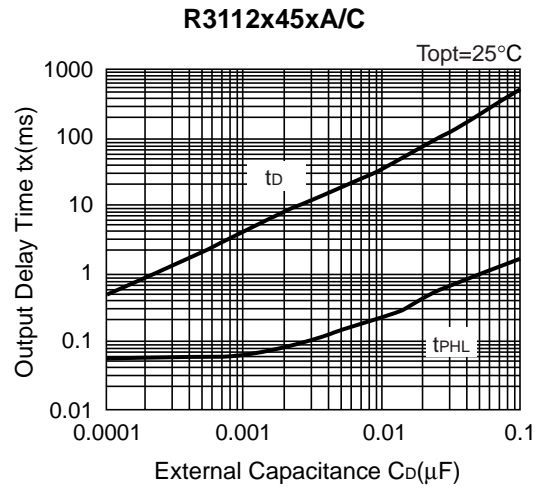
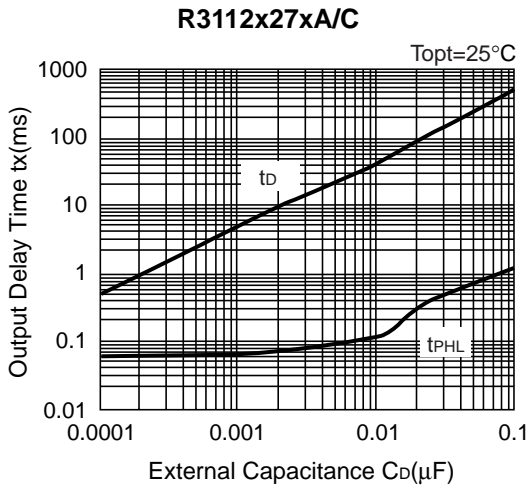

11) Delay Circuit Resistance vs. Temperature

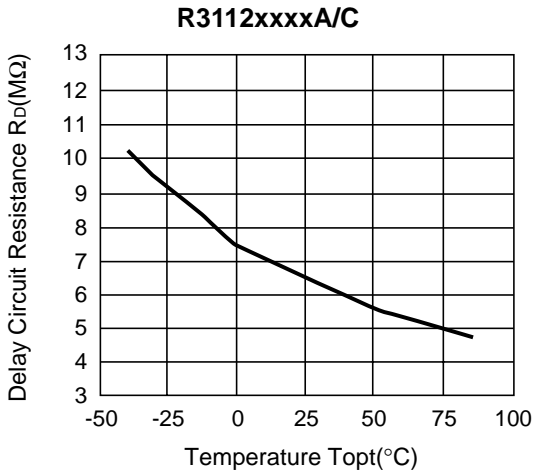

TECHNICAL NOTES

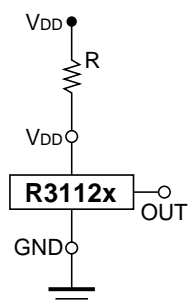

Figure A

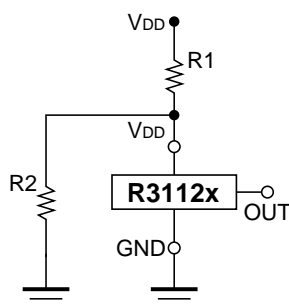

Figure B

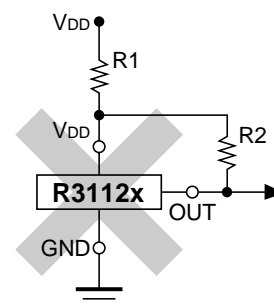

Figure C

When R3112xxxxA (Nch open drain output type) is used in Figure A or Figure B, if impedance of voltage supply pin, V_{DD} and V_{DD} of this IC is large, detector threshold level would shift by voltage dropdown caused by the consumption current of the IC itself. Released voltage may also shift and delay time for start-up might be generated by this usage.

When R3112xxxxC (CMOS output type) is used in Figure A or Figure B, Output level could be unstable by cross conduction current which is generated at detector threshold level or at released voltage level, therefore, do not use R3112xxxxC with the connection in Figure A or Figure B.

The connection in Figure C may cause the oscillation in both R3112xxxxC (CMOS Output) and R3112xxxxA (Nch Open Drain Output), therefore do not use R3112xxxxA/C Series with the connection in Figure C.



1. The products and the product specifications described in this document are subject to change or discontinuation of production without notice for reasons such as improvement. Therefore, before deciding to use the products, please refer to Ricoh sales representatives for the latest information thereon.
2. The materials in this document may not be copied or otherwise reproduced in whole or in part without prior written consent of Ricoh.
3. Please be sure to take any necessary formalities under relevant laws or regulations before exporting or otherwise taking out of your country the products or the technical information described herein.
4. The technical information described in this document shows typical characteristics of and example application circuits for the products. The release of such information is not to be construed as a warranty of or a grant of license under Ricoh's or any third party's intellectual property rights or any other rights.
5. The products listed in this document are intended and designed for use as general electronic components in standard applications (office equipment, telecommunication equipment, measuring instruments, consumer electronic products, amusement equipment etc.). Those customers intending to use a product in an application requiring extreme quality and reliability, for example, in a highly specific application where the failure or misoperation of the product could result in human injury or death (aircraft, spacevehicle, nuclear reactor control system, traffic control system, automotive and transportation equipment, combustion equipment, safety devices, life support system etc.) should first contact us.
6. We are making our continuous effort to improve the quality and reliability of our products, but semiconductor products are likely to fail with certain probability. In order to prevent any injury to persons or damages to property resulting from such failure, customers should be careful enough to incorporate safety measures in their design, such as redundancy feature, firecontainment feature and fail-safe feature. We do not assume any liability or responsibility for any loss or damage arising from misuse or inappropriate use of the products.
7. Anti-radiation design is not implemented in the products described in this document.
8. Please contact Ricoh sales representatives should you have any questions or comments concerning the products or the technical information.

RICOH COMPANY, LTD. Electronic Devices Company



■ Ricoh presented with the Japan Management Quality Award for 1999.
Ricoh continually strives to promote customer satisfaction, and shares the achievements of its management quality improvement program with people and society.



■ Ricoh awarded ISO 14001 certification.
The Ricoh Group was awarded ISO 14001 certification, which is an international standard for environmental management systems, at both its domestic and overseas production facilities. Our current aim is to obtain ISO 14001 certification for all of our business offices.

<http://www.ricoh.com/LSI/>

RICOH COMPANY, LTD.

Electronic Devices Company

● Higashi-Shinagawa Office (International Sales)

3-32-3, Higashi-Shinagawa, Shinagawa-ku, Tokyo 140-8655, Japan
Phone: +81-3-5479-2857 Fax: +81-3-5479-0502

RICOH EUROPE (NETHERLANDS) B.V.

● Semiconductor Support Centre

Prof. W.H.Keesomlaan 1, 1183 DL Amstelveen, The Netherlands
P.O.Box 114, 1180 AC Amstelveen
Phone: +31-20-5474-309 Fax: +31-20-5474-791

RICOH ELECTRONIC DEVICES KOREA Co., Ltd.

11 floor, Haesung 1 building, 942, Daechidong, Gangnamgu, Seoul, Korea
Phone: +82-2-2135-5700 Fax: +82-2-2135-5705

RICOH ELECTRONIC DEVICES SHANGHAI Co., Ltd.

Room403, No.2 Building, 690#Bi Bo Road, Pu Dong New district, Shanghai 201203,
People's Republic of China
Phone: +86-21-5027-3200 Fax: +86-21-5027-3299

RICOH COMPANY, LTD.

Electronic Devices Company

● Taipei office

Room109, 10F-1, No.51, Hengyang Rd., Taipei City, Taiwan (R.O.C.)
Phone: +886-2-2313-1621/1622 Fax: +886-2-2313-1623



Ricoh completed the organization of the Lead-free production for all of our products. After Apr. 1, 2006, we will ship out the lead free products only. Thus, all products that will be shipped from now on comply with RoHS Directive.