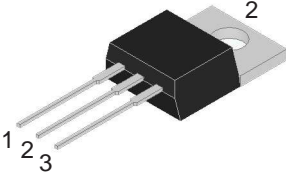
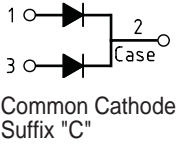

25.0 Amp. Schottky Barrier Rectifier

<p style="font-size: 1.2em; font-weight: bold;">TO-220AB</p>   <p style="font-size: 0.8em;">Common Cathode Suffix "C"</p>	<p style="font-weight: bold;">Voltage</p> <p>45 to 150 V</p> <p style="font-weight: bold;">Current</p> <p>25.0 A</p> <ul style="list-style-type: none"> Plastic material used carries Underwriters Laboratory Classifications 94V-0 Metal silicon junction, majority carrier conduction Low power loss, high efficiency. High current capability, low forward voltage drop High surge capability For use in low voltage, high frequency inverters, free wheeling, and polarity protection applications Guardring for overvoltage protection High temperature soldering guaranteed: 260°C/10 seconds, 6.35mm from case <p style="font-weight: bold;">Mechanical Data</p> <ul style="list-style-type: none"> Cases: JEDEC TO-220AB molded plastic Terminals: Pure tin plated, lead free, solderable per MIL-STD-750, Method 2026 Polarity: As marked Mounting position: Any Mounting torque: 5 in. - lbs. max Weight: 2.24 grams
---	--

Absolute Maximum Ratings, according to IEC publication No. 134

		MBR 2545CT	MBR 2560CT	MBR 25100CT	MBR 25150CT
V_{RRM}	Maximum Recurrent Peak Reverse Voltage (V)	45	60	100	150
V_{RMS}	Maximum RMS Voltage (V)	31	42	70	105
V_{DC}	Maximum DC blocking voltage (V)	45	60	100	150
$I_{F(AV)}$	Maximum Average Forward Rectified Current at $T_C = 130\text{ }^\circ\text{C}$	25 A			
I_{FSM}	Peak Forward Surge Current, 8.3 ms Single Half Sine-wave Superimposed on Rated Load (JEDEC Method)	200 A			
I_{RRM}	Peak Repetitive Reverse Surge Current (Note 1)	1.0 A	0.5 A		
C_j	Typical Junction Capacitance	600 pF	460 pF		
T_j	Operating Junction Temperature Range	- 65 to + 150 °C			
T_{stg}	Storage Temperature Range	- 65 to + 175 °C			

Electrical Characteristics

		MBR 2545CT	MBR 2560CT	MBR 25100CT	MBR 25150CT
V_F	Maximum Instantaneous Forward Voltage at (Note 2) $I_F = 12.5\text{ A}, T_c = 25\text{ }^\circ\text{C}$ $I_F = 12.5\text{ A}, T_c = 125\text{ }^\circ\text{C}$ $I_F = 25\text{ A}, T_c = 25\text{ }^\circ\text{C}$ $I_F = 25\text{ A}, T_c = 125\text{ }^\circ\text{C}$	- - 0.82 V 0.73 V	0.75 V 0.65 V 0.82 V 0.78 V	0.85 V 0.75 V 0.92 V 0.88 V	0.95 V 0.92 V 1.02 V 0.98 V
I_R	Max. Instantaneous Reverse Current @ $T_C=25^\circ\text{C}$ at Rated DC Blocking Voltage Per Leg @ $T_C=125^\circ\text{C}$ (Note 2)	0.2 mA 15 mA	0.2 mA 10 mA	0.1 mA 7.5 mA	0.1 mA 5 mA
R_{thj-c}	Maximum Thermal Resistance Per Leg (Note 3)	1.0 °C/W			

Notes: 1. 2.0µs Pulse Width, f=1.0 KHz
 2. Pulse Test: 300µs Pulse Width, 1% Duty Cycle
 3. Thermal Resistance from Junction to Case Per Leg, with Heatsink Size (101.6 mm x 152.4 mm x 6.35 mm) Al-Plate.

Rating And Characteristic Curves

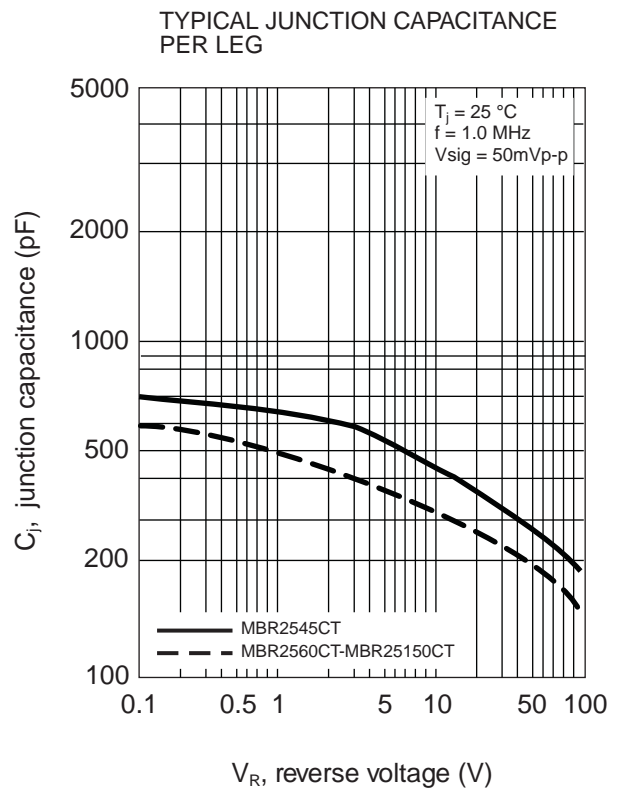
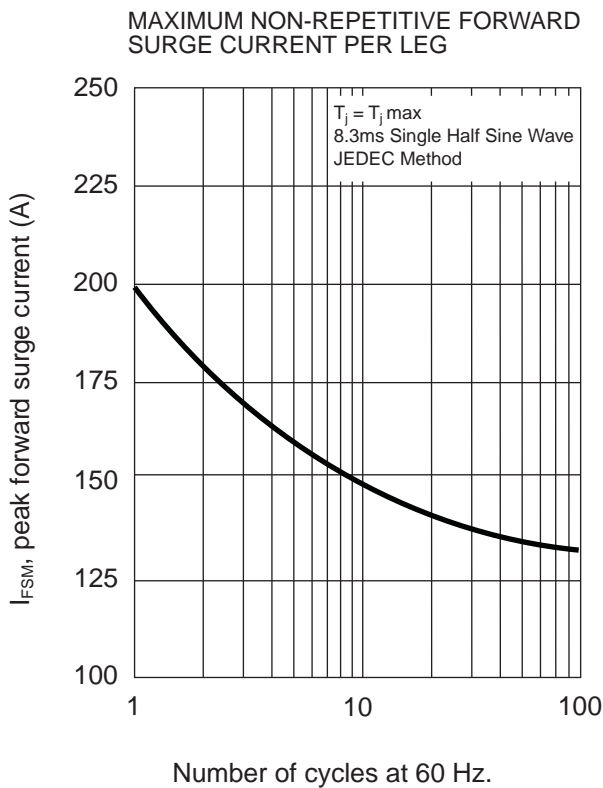
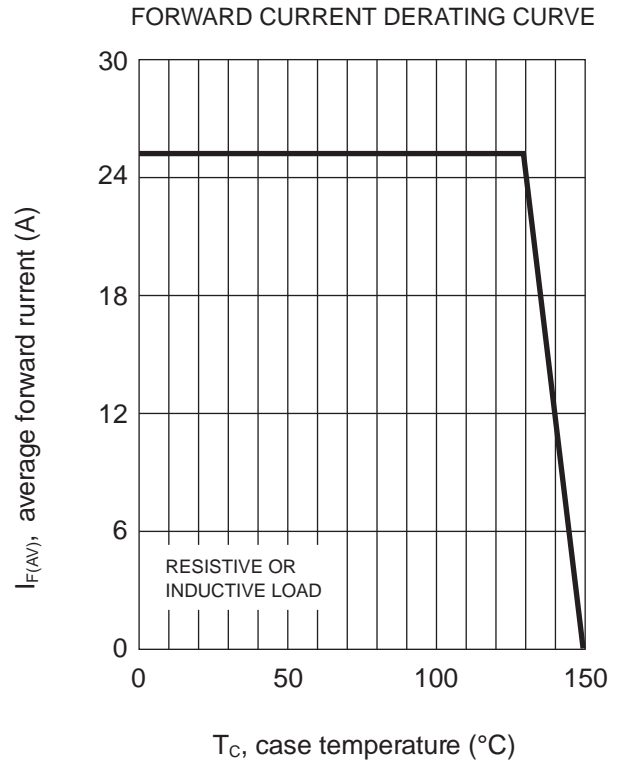
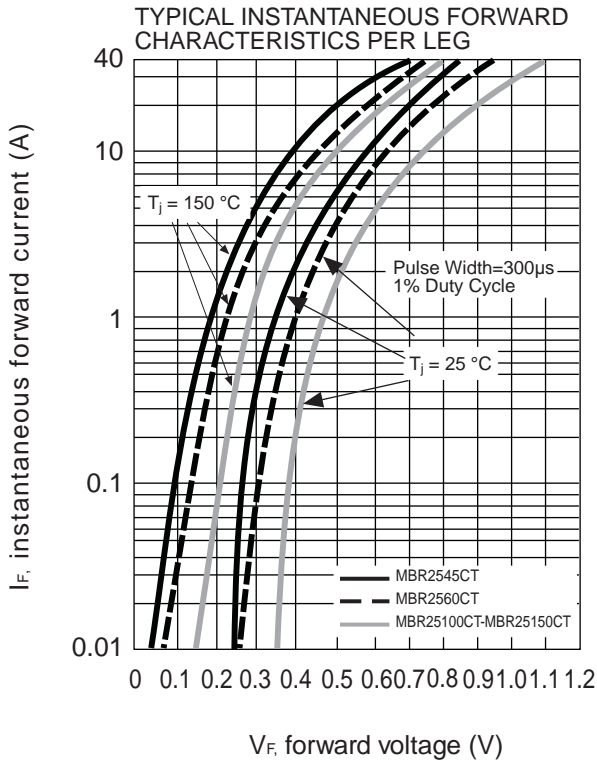

Rating And Characteristic Curves

TYPICAL REVERSE CHARACTERISTICS PER LEG

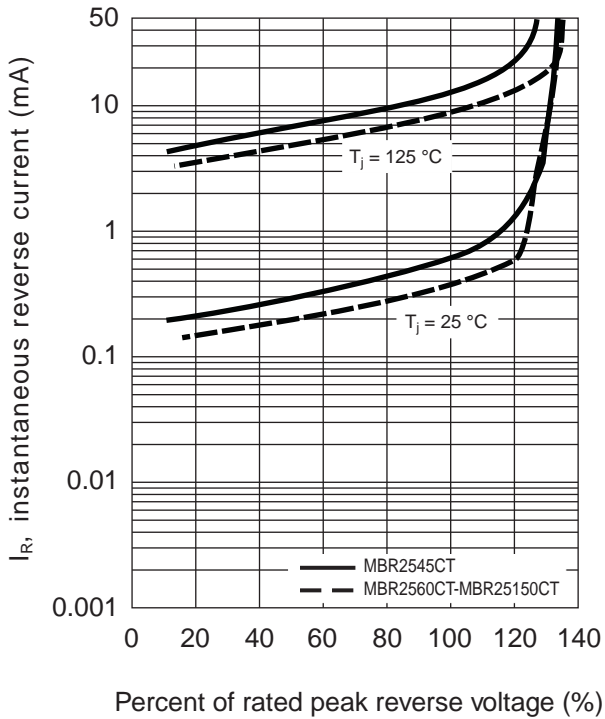

TYPICAL TRANSIENT THERMAL IMPEDANCE PER LEG

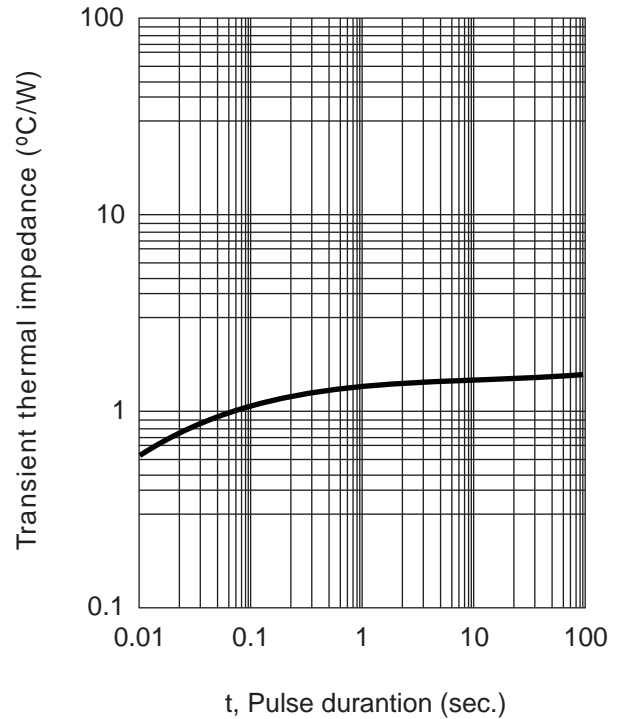

PACKAGE MECHANICAL DATA

TO-220AB

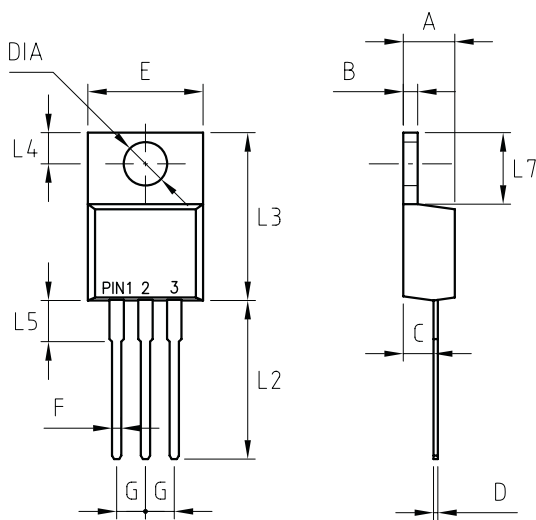

REF.	DIMENSIONS	
	Milimeters	
	Min.	Max.
A	4.44	4.70
B	1.14	1.40
C	2.54	2.79
D	0.35	0.64
E	--	10.5
F	0.68	0.94
G	2.41	2.67
L2	13.46	14.22
L3	14.90	15.10
L4	2.62	2.87
L5	3.56	4.06
L7	5.84	6.86
DIA	3.91	3.74