

Weller®

Weller Filter Systems



Datasheet.Live

COOPER Hand Tools

Weller® Zero-Smog Filter Systems

The Weller Zero-Smog Systems put an end to air pollution caused by soldering, adhesives and laser work. In all of these applications fumes or fine particles are released into the work place atmosphere which are hazardous to staff exposed to them.

The Weller Zero-Smog Systems' combination of Pumps, electronic controls and filters removes this hazard.



Tip Extraction

Weller FE soldering irons have an integral smoke tube mounted in the handle of the iron which when soldering is positioned directly above the joint to collect any fumes generated. Fume extraction irons can be connected to Weller Zero-Smog systems WFE, WFEP bench mounted units driving upto 2 irons or WFE 20 mobile unit driving upto 20 irons.

Fume extraction attachments can be retro fitted to non fume extraction Weller soldering irons.

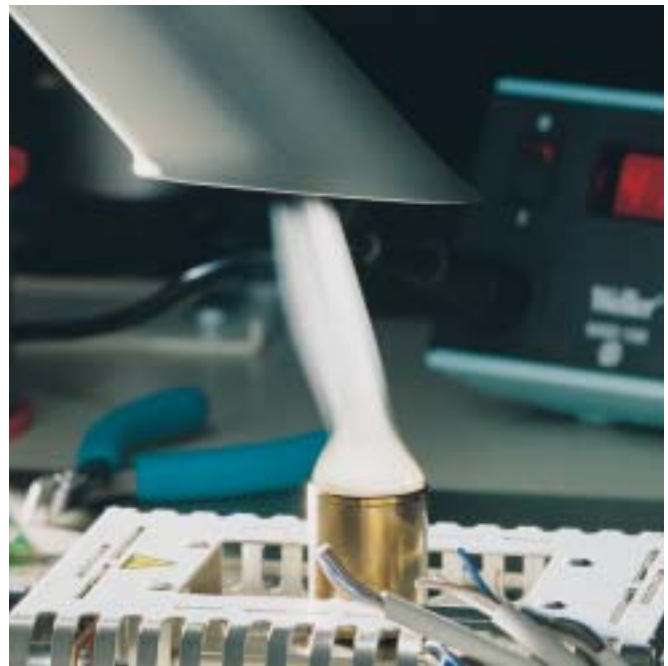

Volume Extraction

For applications where Volume extraction is more suitable, e.g. solder baths, hot air soldering, micro solders and gluing work, Weller offers the mobile systems WFE 2S and WFE 4S. The units purify the air at up to 8 workplaces. A wide range of accessories is available for each mobile system.



Zero-Smog Filter System

Weller Zero-Smog Systems have a three stage filter system for removing fine particles, fumes and gases produced in assembly operations. Filters to meet varying work place requirements are available.

- The main areas where filtration is required are
- Solder /flux fumes
 - Adhesive fumes
 - Pollutants resulting from laser applications

Fine dust filter as per DIN 24185 / EN 779

Filter class	medium filtration efficiency (dust) Am %	medium filtration efficiency (aerosols) Em %	Application
F5	> 97	40 - 60	for standard applications
F7	> 98	80 - 90	for applications with high flux content
F9	> 99	> 95	with pollution gases with high solids content e.g. soldering work with enamel-covered wire or laser tasks

HEPA filter DIN 24184, 24183 / EN 779 HEPA (High Efficiency Particulate Air) Filter

Filter class	Filtration efficiency %	Application
H13	> 99.95	Filter for ultra-clean rooms 1000-100

Filter process

1. Fine dust filter

For standard applications with little flux up to pollution gases with high solids content. Weller offers the filter classes F5, F7 and F9.

2. HEPA filter

Filters particles up to 0.3 µm. Weller offers HEPA (High Efficiency Particulate Air) filters of class H13, medium filtration efficiency 99.95 %.

3. Wide band gas filter

For cleaning harmful fumes and vapours. The Weller wide band filter consists of 50 % active carbon and 50 % Puratex. Harmful gases with a high molecular weight are cleaned by the active carbon. Puratex is suitable for absorbing gases of lower molecular weight. Because of its composition, Puratex is able to convert a large number of chemical pollutants by means of molecular modification into non-polluting gases.

4. Gas filter (option)

The gas filter is used for extracting adhesive fumes and solvents. Experience has shown that filtering suspended particles is not so vital in this respect. The gas filter is filled with 50 % active carbon and 50 % Puratex. The HEPA H 13 is omitted.

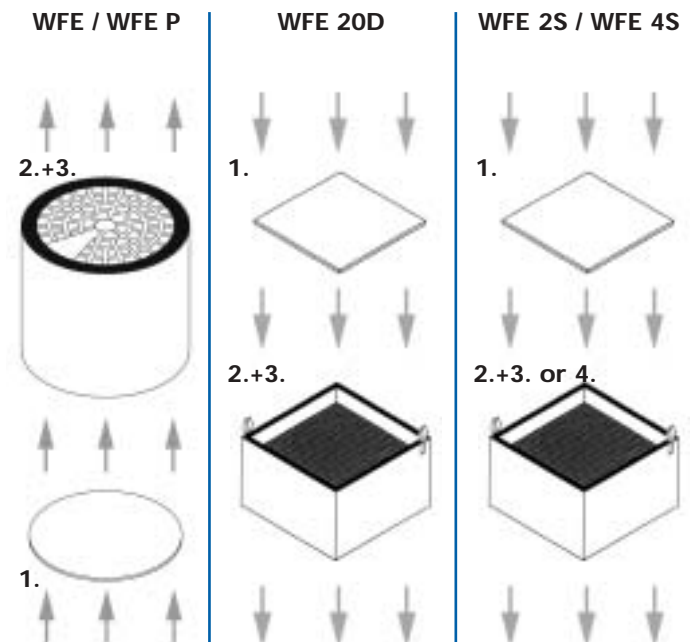

Weller® Zero-Smog

Extraction Systems for all tasks



Tip Extraction

Characteristics

With this option using a FE soldering iron fumes are extracted directly at the soldering tip. See page 8 for the range of Weller FE irons and attachments.

General properties

- High vacuum, upto 12,000 Pa
- Low volume
- Maximum bridging distance 200 m (WFE 20D requires Weller pipe system 50)

Applications

- Hand soldering
- Small solder baths

Special features

- Stop + Go supports to switch the extraction system on when the FE iron is removed from the support and off after a short delay when the iron is replaced (WFE & WFE P only)
- Variable electronically controlled pump speed, adjustable at the unit or by remote control via RS 232 and PC (WFE 20D)
- Filter condition warning, by LED at the unit or remote via RS 232 and PC (WFE 20D)

Units



WFE 20D



WFE

WFE P

Number of work places

20

2

System structure

central + stand alone

central

Weller extraction systems are specifically designed for continuous operation in industry. The high quality of manufacture, care taken in the design stage and component choice have given Weller machines a world wide reputation for reliability and longevity.

Volume extraction

Characteristics

For applications where extraction over a wide area is required

General properties

- Low vacuum upto 2,800 Pa
- High volume
- Max bridging distance 30 m (WFE 4S using Weller pipe system 75)

Areas of application

- Hot air workplaces
- Soldering machines, robots, solder baths
- Laser processing
- Adhesive fumes
- Clean room applications
- microscope workplaces

Special features

- automatic speed control depending on the number of connected workplaces
- the units can be remotely controlled by means of a remote control system available as an accessory or by a PC/PLC connection
- filter condition monitoring at the unit or by remote control (accessories)

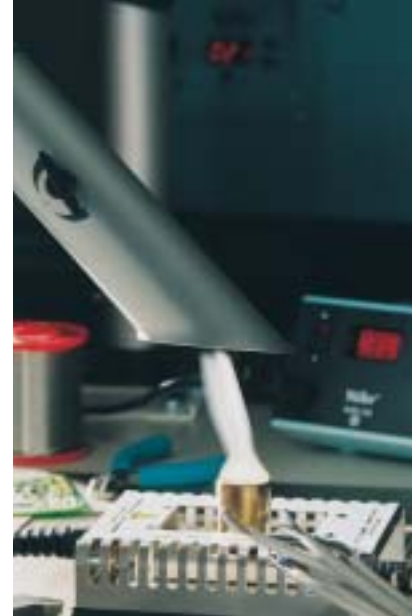

Units



WFE 2S



WFE 4S

Number of work places

4

8

System structure

central

central + stand alone



Tip Extraction Extraction Units

WFE



WFE – Small, portable, quiet, compressed air driven, for stand alone application.

The Weller WFE is a small, portable unit designed for soldering fume extraction with up to two FE soldering irons. The WFE requires clean and oil-free compressed air. The vacuum is generated by a maintenance-free compressed air converter. The contaminated air is purified by a pre-filter and main filter system.

The pre filter consists of a fine dust filter F7.

The compact main filter cartridge consists of a wide band gas filter (50% active carbon, 50% Puratex) and a HEPA filter of class H13. A compressed air cleaning filter removes additional odours caused by the compressed air. This highly efficient filter system makes the WFE a genuine air recovery system. The filter-lift system allows fast and convenient replacement of the filter cartridge. The FE soldering irons are connected directly to the unit - additional leads are not required.

Technical data WFE:

Height	200 mm
Diameter	140 mm
Weight	2,7 kg
Operating pressure	3,5 - 6 bar
Air consumption	30 l/min
Sound level	39 db(A) at 1 m distance
Max. vacuum	max. 20.000 Pa
Max. capacity	2 FE-soldering irons
Order No.:	005 36 402 99



Spare filter for WFE:

- Compressed air-cleaning filter 005 87 357 57
- Compact filter 005 36 410 99 consists of:
 - HEPA filter (H13)
 - Wide band gas filter (50 % active carbon, 50 % Puratex)
- Fine dust filter (F7) 005 36 421 99 (3 pieces)



WFE P

**New:
2 Power stages for
higher extraction
performance with
2 FE soldering irons.**



WFE P – small, portable, quiet, electrically driven, for central application

The Weller WFE P is soldering fume extraction unit runs with line voltage for one or two FE soldering irons. In contrast to the WFE, an electric, long-life and optimally soundproofed vacuum pump guarantees the required vacuum, this making the WFE P independent of compressed air. The vacuum pump has two power stages, which can be set by means of rocker switches according to the number of connected FE soldering irons. This saves energy. The motor is maintenance-free and has a thermal over load to protect the unit.

The WFE P has a three stage filter system comprising a F7 grade fine dust filter, and main filter consisting of a wide band gas filter (50% active carbon and 50% puratex) and a HEPA class 13 fine particle filter.

The Filter lift system allows fast and convenient main filter replacement.

FE irons are connected directly to unit additional leads are not required.

Technical data WFE P:

Height	295 mm
Diameter	140 mm
Weight	4 kg
Operating voltage	230 V / 50 Hz
Power input	50 W
Sound level	45 db(A) at 1 m distance
Max. vacuum	30,000 Pa
Max. capacity	2 FE soldering irons
Order No.:	005 36 386 99 (UK: 005 36 383 99)



Spare filter for WFE P:

- Compact filter 005 36 410 99 consists of:
 - HEPA filter (H 13)
 - Wide band gas filter (50 % active carbon, 50 % Puratex)
- Fine dust filter (F7) 005 36 421 99 (3 pieces)

Accessories for WFE and WFE P

For FE soldering irons and Stop + Go supports, see pages 8/9. Installation option see page 10.

WFE 20D



New:
Electronically controlled
turbine.
Interface RS 232 for
remote control.

WFE 20D – mobile, powerful, electronically controlled, for central or stand alone application

The WFE20D is designed for tip extraction applications. Upto 5 Weller FE soldering irons can be connected directly; indirectly, via pipe system 50 available as an accessory: up to 20 FE soldering irons.

The powerful maintenance-free turbine generates a vacuum of 12.000 Pa and is electronically controlled. The operating hours and the level of filter contamination are also recorded electronically.

The filter system has three stages. It comprises a fine dust filter F5 and a compact filter, consisting of a HEPA filter H13 and a wide band gas filter (50 % active carbon, 50 % Puratex). The filter system achieves a filtration rate of 99.95 % as per EN 1822 with a particle size of 0.12 µm.

Further features:

- Two selectable operating modes:
 - Mode 0: vacuum regulated to 12,000 Pa
 - Mode 1: extraction performance can be set individually between 20 % – 100 % with the buttons
- Electronic filter check (LED) through differential pressure measurement. If the specified degree of contamination is exceeded, the unit switches off.
- Electronic filter operation status display. For better management of the filter change intervals, the filter operating hours can be pre-specified. The necessary filter change is indicated in good time, thus optimising filter procurement and replacement.
- Interface RS 232 for remote monitoring or remote control.
- With the remote control, available as an accessory, the following functions can be controlled:
 - Switching the unit on/off
 - Speed setting (only in mode 1)
 - Filter status display

Technical data WFE 20D:

Dimensions (LxWxH):	450 mm x 450 mm x 695 mm
Weight:	45 kg
Operating voltage:	230 V
Power input:	630 VA
Sound level:	51 dB(A)
Max. vacuum:	12,000 Pa
Max. delivery rate:	100 m ³ /h
Max. capacity:	20 FE soldering iron

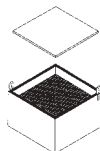

Spare filters WFE 20D:•

- Fine dust filter (F5) 005 87 358 37
 - Compact filter (F7) 005 87 358 36
 - Compact filter 005 87 358 38
- Consists of:
- HEPA filter (H 13)
 - Wide band gas filter (50% active carbon, 50 % Puratex)

Order No.: **005 36 476 99**
(UK: 005 36 473 99)

Accessories WFE 20D:

For FE soldering irons and Stop + Go supports, see pages 8/9.
For other accessories, see page 10/11.
For pipe system 50, see page 18.







Tip Extraction Accessories

FE Soldering Irons

Weller FE soldering irons are specifically designed for tip extraction applications. The smoke tube is integral with the handle and is normally placed over the joint when soldering but can be retracted when access to the joint is a problem and can be removed for cleaning. The irons are temperature controlled, ergonomic and allow precise handling. The electronically controlled irons can be driven

from any PU /PUD series power unit compatible with the rating of the iron or any rework station. FE 50M irons can only be driven from the P51 power unit. The range of iron power ratings and the extensive range of solder tips mean that there is an iron to suit all applications. The FE irons are supplied with a 5 mm-dia. burn proof hose 2.5 m long, all handles leads and hoses are ESD safe.

	Model / Description	Support	Order No.
	FE 50 Soldering pencil 50 W	AK 20, KH 20*	005 25 153 99
	FE 50 Soldering iron set with safety rest KH 20		005 33 150 99
	FE 50M Soldering pencil with Magnastat control system 50 W	AK 20, KH 20*	005 32 152 99
	FE 75 Soldering iron 80 W	AK 20, KH 20*	005 29 166 99
	FE 75 Soldering iron set with safety rest KH 20		005 33 151 99
	WSP 80 FE Soldering pencil 80 W	WPH 80	005 29 162 99
	FE 80 Soldering iron 80 W	AK 20, KH 20*	005 26 162 99

* Fume extraction funnels specific to FE irons are included in the scope of supply of the soldering irons for use with KH20 and KH 23 bench supports.

FE attachments

A range of FE attachments are available to fit to Weller soldering and desoldering irons to convert standard products to fume extraction versions. The attachments are

supplied with all necessary fittings and hoses. The performance of the retrofitted tools is not affected.

	Model / Description	Required Support	Order No.
	For WSP 80 Soldering pencil	WPH 80	005 29 167 99
	For WMP Soldering pencil	WPHM	005 29 177 99
	For MLR 21, MLR 80 Soldering pencil	WPH 80	005 29 127 99
	For LR 21, LR 82, TCP S Soldering iron	AK 20	005 25 125 99
	For W 61, W 101, WSP 150 Soldering iron	AK 1	005 25 125 99
	For WSF 80D5/8 Soldering tin feed system	AK S (included)	005 28 126 99
	For DS 22, DS 80, DSX 80 Desoldering iron	AK 20	005 13 125 99

Locking clip

The locking clip is used to disconnect FE soldering irons that are not required so that extraction power is not lost unnecessarily. The clip can be operated quickly and conveniently.



Order No.: 005 36 352 99

Extraction hose (spare)

Heat-resistant silicone hose, ø 5 mm for all FE soldering irons (sold by metre)



Order No.: 005 25 410 00

Supports and holders for FE soldering irons

			
AK 20	KH 20*	KH 23*	WPH 80
Support for FE 50, FE 50M, FE 75, FE 80	Support for FE 50, FE 50M, FE 75, FE 80 with FE attachment: LR 21, LR 82, TCPS	Support for FE 25, MLR 21FE	Support for WSP 80FE with FE attachment: MLR 21, WSP 80
005 15 030 99	005 15 020 99	005 15 023 99	005 15 140 99

* Fume extraction funnels specific to FE irons are included in the scope of supply of the soldering irons for use with KH20 and KH 23 bench supports

Stop + Go supports for FE soldering irons together with WFE and WFE P

The Weller Stop + Go supports are recommended accessories for FE irons using the WFE or WFE P extraction units. A fibre optic sensor switches the extraction unit on when the FE iron is removed from the bench support

and when the FE iron is replaced in the bench support, after a short delay to gather the fumes from any solder on the tip it switches the unit off. This reduces running costs.

FE soldering irons	Basic unit Stop + Go and a support with fibre optic sensor for: WFE (pneumatic)	for: WFE P (electric)	2. support with fibre optic sensor for extending the Stop + Go basic unit for 2 workplaces
FE 25 FE 50 FE 50M FE 75 FE 80	 KHP 005 15 086 99	 KHE 005 15 076 99	 KHE / P 005 15 080 99
WSP 80FE	 KHP 80 005 15 084 99	 KHE 80 005 15 083 99	 KHE / P 80 005 15 141 99

Cord support

The cord support keeps the cord of the soldering iron out of the direct working area. This allows an easy

handling of the soldering iron. Especially recommended for use with FE soldering irons.



Modello / Descrizione

Spring holder for AK 20
Spring holder for KH 23

Codice articolo

005 15 065 99
005 15 066 99



Tip Extraction Accessories

Installation option for a central system with WFE P

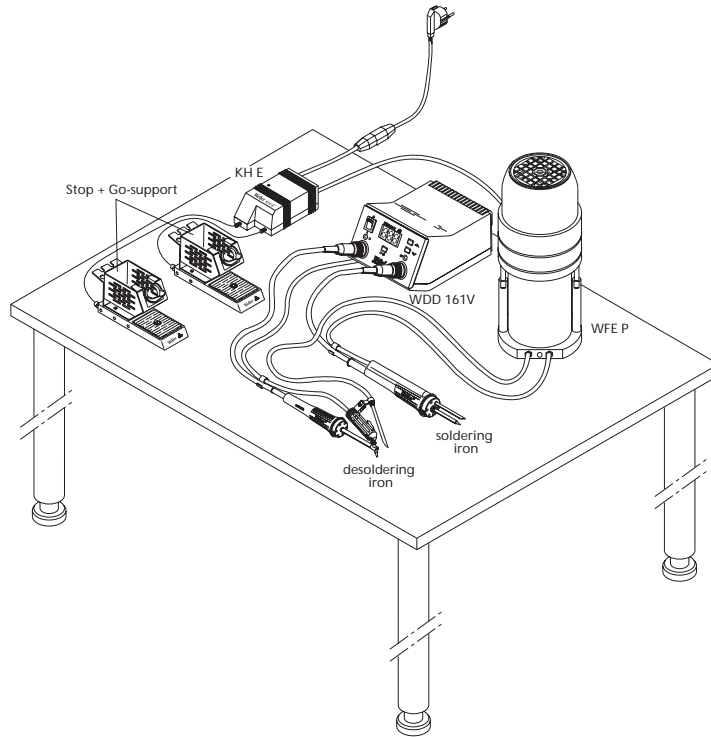





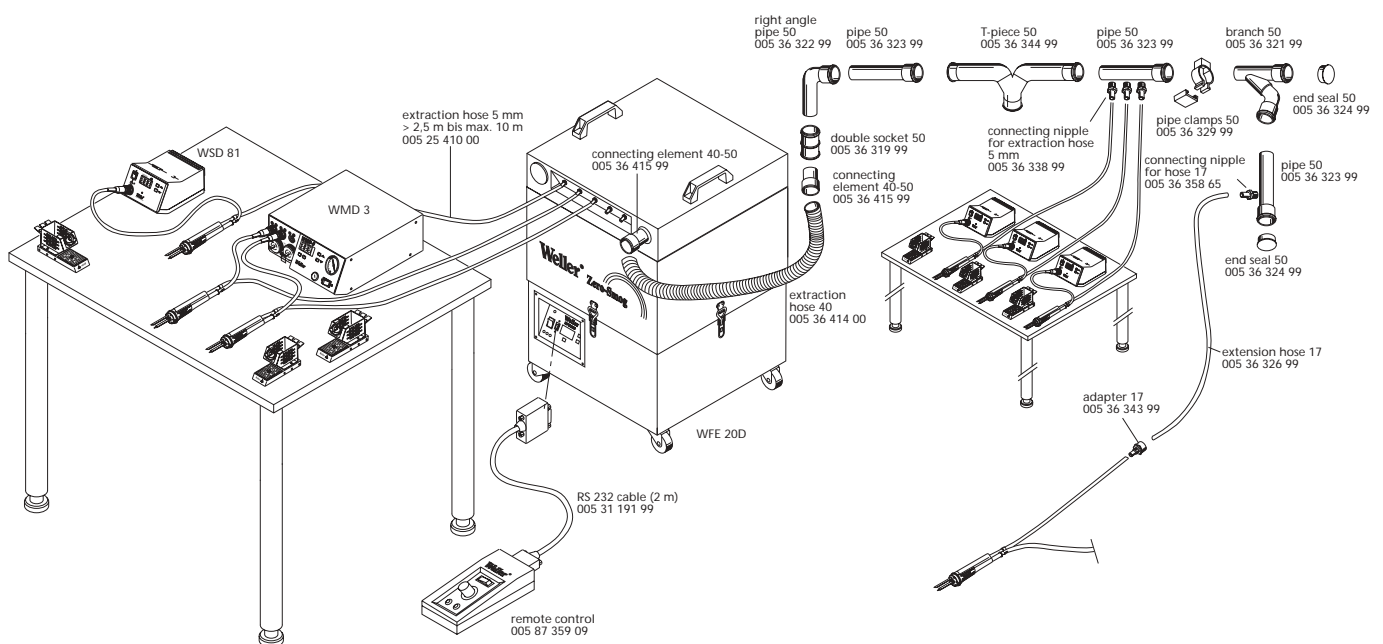

Installation option for a central and stand alone system with WFE 20D

central system

stand alone system with pipe system 50 upto ca. 200 m



Accessories for tip extraction

	Description	Order No.
	<p>Extraction hose 40,1 m, ø 40 mm dia., complete. With 2 connecting elements for direct connection of unit (WFE 20D) to pipe system 50, plastic, grey/black, flexible.</p>	005 36 316 99
	<p>Extraction hose 40, ø 40 mm dia. without connecting elements (sold by metre), plastic, grey/black, flexible.</p>	005 36 414 00
	<p>Connecting element 40-50 for connecting extraction hose 40 and pipe system 50, rubber, black.</p>	005 36 415 99
	<p>17 mm dia. x 5 m long extension hose. Used where the fume extraction iron is further than 2.5 m from the pipe system 50. Note connection nipple for hose 17 and adapter 17 will be required, plastic, transparent.</p>	005 36 326 99
	<p>Connection nipple for hose 17. Amend direction to read direct.</p>	005 87 358 65
	<p>Nut G 3/8" for connection nipple.</p>	005 87 358 66
	<p>Adapter 17. Adapts 17 mm dia hose to 5 mm dia hose on FE iron.</p>	005 36 343 99
	<p>Connection nipple for 5 mm dia extraction hose to connect FE irons directly to pipe system 50. The connection nipple is screwed at any point into the pipe system.</p> <p>Amend cap closure to Dust cap.</p>	005 36 338 99 005 87 350 50



Volume Extraction Extraction Units

WFE 2S



WFE 2S – small, portable, quiet with electronic speed control, for centralised applications.

The Weller WFE 2S extraction unit purifies the air at up to two workplaces. It is designed as a central system directly at the workplace. A powerful, maintenance-free pump provides continuous fume extraction at a maximum air extraction rate of 230 m³/h. A built-in microprocessor controls the adjustable pump speed. This avoids unnecessary waste of suction power and saves energy. The three-stage filter system is included in the scope of delivery and can be replaced easily. It comprises a fine dust filter (F5) and a combined HEPA filter and wide band gas filter. The WFE 2S extraction unit is supplied with a pipe connecting element 50 for the extraction hose 50. The extensive range of accessories, such as extraction nozzles and hoods, allows versatile and flexible use of the system.

Features:

- Speed set by rotary potentiometer
- Red/Green LED to indicate filter condition
- RS 232 interface for remote control via PC

Technical data WFE 2S:

Dimensions: 320 x 320 x 395
(L x W x H mm)

Weight: 19 kg

Operating voltage: 230 V

Power input: 275 VA

Sound level: 48 db(A) in
1 m distance

Max. vacuum: 2.700 PA

Max. extraction rate: 230 m³/h

Max. capacity: 2 work places

Standard connection: pipe system 50

Order No.: **005 36 266 99**
(UK: 005 36 363 99)



Spare filters for WFE 2S:

- Fine dust filter (F5) 005 87 358 84 (10 units) (F7) 005 87 358 85
- Compact filter 005 87 358 83 consists of:
 - HEPA filter (H13)
 - Wide band gas filter (50% active carbon, 50% Puratex)
- Option: adhesive fume filter (50 % active carbon, 50 % Puratex without HEPA filter H13) 005 87 358 95

WFE 2S with gas filter

as above but with adhesive fume filter

Order No.: **005 36 466 99**
(UK: 005 36 463 99)

WFE 2 Kit 1



WFE 2 Kit 2



WFE 2 K1 / K2 Stand alone extraction systems for one or two work places.

The tried and tested Weller WFE 2S fume extraction system is available in two user friendly, stand alone systems. Designed for use in industrial, service and laboratory applications these units are supplied complete with flexible hoses, extraction arms, mounting brackets and system seals, ready for installation in situ. Additional extraction arms with other extraction nozzles, extraction hoods and plates are available as optional extras. All arms hoses and hoods are ESD safe.

WFE 2 Kit 1 (for one work station) consists of:

- 1 Solder fume extraction unit WFE 2S
- 1 Extraction arm with nozzle WFAN 50 flexible, 50 mm dia.
- 1 Bench mounting bracket WFTB 50
- 1 System seal WFFMP 50
- 1 Extraction hose 50 mm dia x 3 m long (005 87 353 27)

Order No.: **005 36 436 99**
(UK: 005 36 433 99)

WFE 2 Kit 1 with gas filter

as above but with adhesive fume filter

Order no.: **005 36 446 99**
(UK: 005 36 443 99)

WFE 2 Kit 2 (for two work stations) consists of:

- 1 Solder fume extraction unit WFE 2S
- 2 Extraction arm with nozzle WFAN 50, flexible, 50 mm dia.
- 2 Bench bench mounting brackets WFTB 50
- 2 System seals WFFMP 50
- 2 Extraction hoses 50, 3 m, ø 50 mm (005 87 353 27)
- 1 Hose connector 50 (005 87 358 47)

Order No.: **005 36 456 99**
(UK: 005 36 453 99)

WFE 2 Kit 2 with gas filter

as above but with adhesive fume filter

Order No.: **005 36 486 99**
(UK: 005 36 483 99)

WFE 4S



WFE 4S – mobile, powerful, electronically controlled suitable for central or stand alone applications.

The WFE 4S is able to extract fumes from up to 8 workstations. The powerful maintenance free variable speed pump is electronically controlled, and has a maximum capacity of 615m³/h. It has 3 operating modes. Standard speed control selected by the user irrespective of the load on the system. Speed limiting control, when the pump speed is automatically varied to match the load on the system and Economy control, when the rate of fume absorption is maintained at a constant value.

The operating hours and the filter condition is also recorded. A three-stage filter comprising a fine dust filter (F5), HEPA filter and wide band gas filter is fitted to the standard unit but an adhesive fume absorption filter can be fitted. A flanged connecting pipe suitable for connection to the Weller pipe system 75 is supplied. A wide range of system 75 pipes, fittings and accessories are available to meet all installations and applications.

Features:

- 3 operating modes
- LED display for filter condition indication
- RS 232 interface for remote control via a PC

Technical data WFE 4S:

Dimensions: (L x W x H)	450 x 450 x 650 mm
Weight:	21 kg
Operating voltage:	230 V/ Hz
Power input:	450 VA
Noise level:	51 db(A) at 1 m distance
Max. vacuum:	2,800 Pa
Max. extraction rate:	615 m ³ /h
Max. capacity:	8 work places
Standard connection:	pipe system 75
Order No.:	005 36 256 99 (UK: 005 36 253 99)

WFE 4S with gas filter:

as above but with adhesive fume filter	
Order No.:	005 36 496 99 (UK: 005 36 493 99)

Spare filter + special filter for WFE 4S:



- Fine dust filter (F5) 005 87 358 37
(10 units) (F7) 005 87 358 36
- Compact filter 005 87 358 38
consists of:
- HEPA filter (H13)
- Wide band gas filter
(50% active carbon, 50% Puratex)
- Special filter (option):
adhesive fume filter 005 87 358 35
(50 % active carbon,
50 % Puratex
without HEPA filter H13)

Pre Filter

To extend capacity of WFE 2S and WFE 4S units.

The pre filter is recommended for use with solder-bath, automatic soldering and laser applications. It acts as a first stage in the filter process thereby increasing the lifetime of the main filter units.

The pre filter can be fixed directly to the top of the WFE 4S or in series with it or the WFE 2S as an integral element of the extraction system

Scope of supply:

- Filter box
- Fine dust filter (F7) 005 87 358 60
- 2 x hose 005 87 358 32
connections 75

Order No.: **005 87 358 62**



Volume Extraction Accessories

Installation option for a central system with WFE 2S

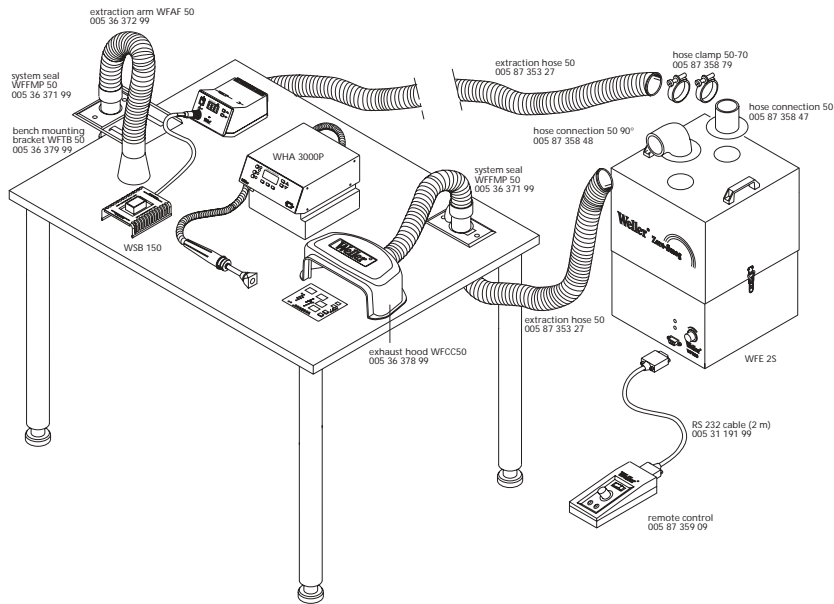





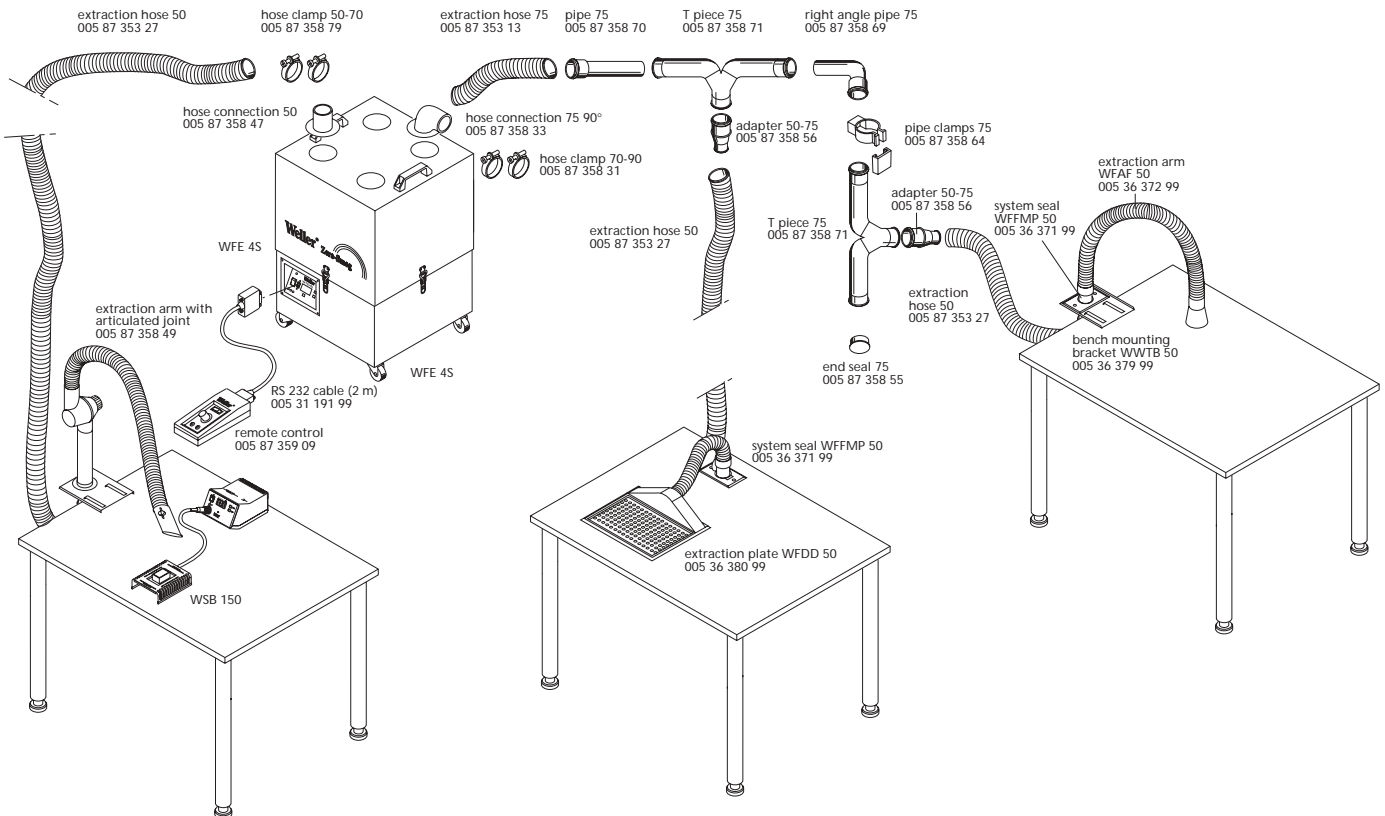

Installation option for a central and stand alone system with WFE 4S

with pipe system 75
upto ca. 30 m

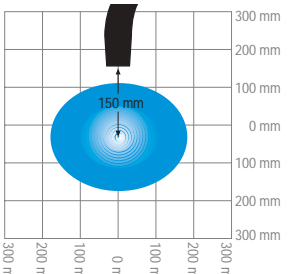

Accessories for volume extraction

	Description	Order No.
	Hose connection 50 for WFE 2S, e.g. for the direct connection of accessories by means of extraction hose 50. Plastic, black.	005 87 358 47
	Hose connection 75 for WFE 2S and WFE 4S, e.g. for connection to a stand alone system by means of pipe 75 or extraction hose 75. Plastic, black.	005 87 358 32
	Hose connection 50, 90° for WFE 2S, e.g. for the direct connection of accessories by means of extraction hose 50. Plastic, black.	005 87 358 48
	Hose connection 75, 90° for WFE 2S and WFE 4S, e.g. for connection to a stand alone system by means of pipe 75 or extraction hose 75. Plastic, black.	005 87 358 33
	Extraction hose 50, ø 50 mm dia., sold by metre, for the direct connection of accessories . Plastic, grey/black, flexible.	005 87 353 27
	Extraction hose 75, ø 75 mm dia., sold by metre, for connection to pipe system 75. Plastic, grey/black, flexible.	005 87 353 13
	Hose clamp 50 – 70 mm , 2 units, for securing extraction hose 50.	005 87 358 79
	Hose clamp 70 – 90 mm , 2 units, for securing extraction hose 75.	005 87 358 31
	Extraction arm 50 mm dia flexible extraction arm with articulated joint and airflow control valve and bench clamp. ESD safe.	005 87 358 49
	Extraction arm WFAN 50 50 mm dia flexible extraction arm with nozzle, for use with WFFMP 50 system seal. ESD safe. Max. length 800 mm.	005 36 374 99
 <p>The diagram shows a grid with a vertical axis from -300 mm to 300 mm and a horizontal axis from -300 mm to 300 mm. A blue circular area is centered at (0,0) with a diameter of 150 mm, indicated by a double-headed arrow. A black nozzle is positioned above the center of the circle.</p>		



Volume Extraction Accessories

Accessories for volume extraction

Description	Order No.		
	<p>Extraction arm WFAF 50 50 mm dia flexible extraction arm with 100 mm dia funnel, for use with WFFMP 50 system seal. ESD safe. Max. length 840 mm.</p>		005 36 372 99
	<p>Extraction arm WFAS 50 50 mm dia flexible extraction arm with 210 x 20 mm flat nozzle, for use with WFFMP 50 system seal. ESD safe. Max. length 820 mm.</p>		005 36 373 99
	<p>Exhaust hood WFCC 50 240 x 100 mm with flexible hose 1m long, recommended for use with hot air soldering operations, for use with WFFMP 50 system seal. ESD safe.</p>		005 36 378 99
	<p>Exhaust hood, 200 x 100 mm recommended for use with hot air soldering operations uses extraction hose 50.</p>		005 87 358 45

Accessories for volume extraction

	Description	Order no.
	<p>Extraction plate WFDD 50 300 x 210 mm with 1m flexible hose, for adhesive and solvent fume extraction. Uses system seal WFFMP 50. ESD safe.</p>	005 36 380 99
	<p>Extraction bench 40 effective working area 600 x 350 mm, for adhesive and solvent fume extraction. Hose connections from side or below. Check hose size info quotes extraction hose 40 and adapter 40-50 neither of which are listed.</p>	005 36 370 99
	<p>System seal WFFMP 50 can be mounted directly to work bench or to mounting bracket. It has a spring loaded cover to physically seal the system if an accessory is withdrawn. Connects to hose 50. ESD safe.</p>	005 36 371 99
	<p>Bench mounting bracket WFTB 50 for WFFMP 50. Metal, black.</p>	005 36 379 99
		

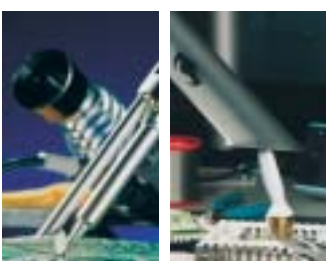

Accessories for Tip and Volume Extraction

Pipe systems for bridging long distances

Pipe system 50

Tip extraction systems demand a high value and constant level of vacuum across the installation, the volume of air extracted is of lesser importance. To achieve this it is necessary to use a pipe system with relatively small diameter. The Weller pipe system 50 allows extraction installations of up to 200 m when used with the WFE 20D unit in a stand alone system









The pipe sections are designed to push together and have internal sealing bushes.

In a central system, the FE irons are connected directly to the fume extraction units

Pipe system 75

Volume extraction systems require a large volume of air to be extracted and the level of vacuum is of lesser importance. This means that a relatively large diameter pipe system is required, if the pipe dia was too small the flow resistance would increase and extraction capacity reduced. The pipe system 75 allows installations up to 30 m. with the WFE 4S used in a stand alone system.

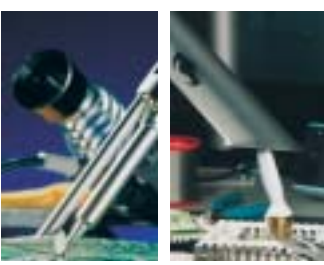

The pipe sections are designed to push together and have internal sealing bushes.

	Description	Order No.	
		Pipe System 50	Pipe System 75
	Pipe, 2 m, with seal at one end, plastic, black.	005 36 323 99	005 87 358 70
	Right angle Pipe, 90°, 0.5 m, with seal at one end, plastic, black.	005 36 322 99	005 87 358 69
	T-piece, 2 x 90°, 1 m, with 3 seals, plastic, black.	005 36 344 99	005 87 358 71
	Branch, 2 x 45°, 1 m, with 2 seals, plastic, black.	005 36 321 99	–
	Double socket, plastic, black.	005 36 319 99	005 87 353 18
	End seal, plastic, transparent.	005 36 324 99	005 87 358 55
	Pipe clamps for pipes, e.g. for securing to wall, plastic, grey.	005 36 329 99	005 87 358 64
	Adapter pipe system 75 to pipe system 50 with seals.		005 87 358 63
	Adapter pipe system 75 to pipe system 50 without seals.		005 87 358 56





Accessories for all Weller Zero- Smog Systems

Exhaust accessories for removing filtered air

	Description	Order No.
	Pipe 100, 2 m , ø 100 mm dia., without seal, for use with WFE 20D and WFE 4S, plastic, black.	005 36 315 99
	Pipe 100, 90°, 05 m, ø 100 mm dia., with seal, for use with WFE 20D and WFE 4S, plastic, black.	005 36 353 99
	Exhaust adapter of pipe 100 to WFE 20D.	005 87 359 20
	Exhaust adapter of pipe 100 to WFE 4S.	005 87 358 40
	Exhaust adapter of pipe 75 for WFE 2S.	005 87 354 13

Remote control

	Description	Order No.
	Using the Weller remote control, the following functions of the extraction units WFE 20D, WFE 2S and WFE 4S can be controlled remotely: <ul style="list-style-type: none"> • Switching unit on/off • Speed setting (only WFE 2S / WFE 4S) • Filter status display 	005 87 359 09
	Interface cable RS 232, 2 m for remote monitoring by PC (type 1:1). Other lengths are available in specialist shops.	005 31 191 99

Units for tip extraction

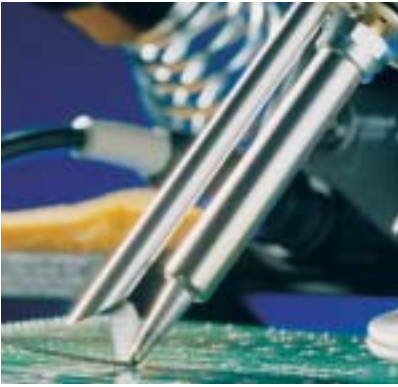

WFE



Portable solder fume extraction unit Compressed air-driven for up to 2 FE soldering irons.

Consists of:

- Extraction unit
- Compressed air cleaning filter
- Fine dust filter F7
- Compact filter (consists of HEPA filter and wide band gas filter)

Order No. 005 36 402 99

WFE P



Portable solder fume extraction unit with built-in turbine for up to 2 FE soldering irons.

Consists of:

- Extraction unit
- Fine dust filter F7
- Compact filter (consists of HEPA filter and wide band gas filter)

Order No. 005 36 386 99
(UK: 005 36 383 99)

WFE 20D



Mobile solder fume extraction unit with built-in turbine for up to 20 FE soldering irons.

Consists of:

- Extraction unit
- Fine dust filter F5
- Compact filter (consists of HEPA filter and wide band gas filter)

Order No. 005 36 476 99
(UK: 005 36 473 99)

Units for volume extraction



WFE 2S



Portable solder fume extraction unit with built-in turbine for up to 4 workplaces.

Consists of:

- Extraction unit
- Fine dust filter F5
- Compact filter (consists of HEPA filter and wide band gas filter)
- Hose connection 50

Order No. 005 36 266 99
(UK: 005 36 263 99)

WFE 4S



Mobile solder fume extraction unit with built-in turbine for up to 8 workplaces.

Consists of:

- Extraction unit
- Fine dust filter F5
- Compact filter (consists of HEPA filter and wide band gas filter)
- Hose connection 75

Order No. 005 36 256 99
(UK: 005 36 253 99)

COOPER Hand Tools

GERMANY
Cooper Tools GmbH
Carl-Benz-Str. 2
74354 Besigheim
Tel: (07143) 580-0
Fax: (07143) 580-108

GREAT BRITAIN
Cooper Tools Ltd.
Suite 15, Coniston House
Town Centre
Washington, Tyne & Wear
NE38 7RN
Tel: (0191) 419 7700
Fax: (0191) 417 9421

FRANCE
Cooper Tools S.A.
25 Rue Maurice Chevallier BP 46
77832 Ozior-la-Ferriere Cedex
Tel: (1) 60.18.55.40
Fax: (1) 64.40.33.05

ITALY
Cooper Italia S.p.A.
Viale Europa 80
20090 Cusago (MI)
Tel: (02) 9033101
Fax: (02) 90394231

SWITZERLAND
Erem S.A.
Rue de la Rosellière 8
1400 Yverdon les Bains
Tel: (024) 426 12 06
Fax: (024) 425 09 77