

FEATURES

Qualified for automotive applications (ADA4853-3W only)

Ultralow disable current: 0.1 μ A

Low quiescent current: 1.4 mA/amplifier

Ideal for standard definition video

High speed

100 MHz, -3 dB bandwidth

120 V/ μ s slew rate

0.5 dB flatness: 22 MHz

Differential gain: 0.20%

Differential phase: 0.10°

Single-supply operation

Rail-to-rail output

Output swings to within 200 mV of either rail

Low voltage offset: 1 mV

Wide supply range: 2.65 V to 5 V

APPLICATIONS

Automotive infotainment systems

Automotive safety systems

Portable multimedia players

Video cameras

Digital still cameras

Consumer video

Clock buffer

GENERAL DESCRIPTION

The ADA4853-1/ADA4853-2/ADA4853-3 are low power, low cost, high speed, rail-to-rail output op amps with ultralow power disables that are ideal for portable consumer electronics. Despite their low price, the ADA4853-1/ADA4853-2/ADA4853-3 provide excellent overall performance and versatility. The 100 MHz, -3 dB bandwidth, and 120 V/ μ s slew rate make these amplifiers well-suited for many general-purpose, high speed applications.

The ADA4853-1/ADA4853-2/ADA4853-3 voltage feedback op amps are designed to operate at supply voltages as low as 2.65 V and up to 5 V using only 1.4 mA of supply current per amplifier. To further reduce power consumption, the amplifiers are equipped with a disable mode that lowers the supply current to less than 1.5 μ A maximum, making them ideal in battery-powered applications.

The ADA4853-1/ADA4853-2/ADA4853-3 provide users with a true single-supply capability, allowing input signals to extend 200 mV below the negative rail and to within 1.2 V of the positive rail. On the output, the amplifiers can swing within 200 mV of either supply rail. With their combination of low price, excellent differential gain (0.2%), differential phase (0.10°), and 0.5 dB flatness out to 22 MHz, these amplifiers are ideal for video applications.

Rev. F

Information furnished by Analog Devices is believed to be accurate and reliable. However, no responsibility is assumed by Analog Devices for its use, nor for any infringements of patents or other rights of third parties that may result from its use. Specifications subject to change without notice. No license is granted by implication or otherwise under any patent or patent rights of Analog Devices. Trademarks and registered trademarks are the property of their respective owners.

PIN CONFIGURATIONS

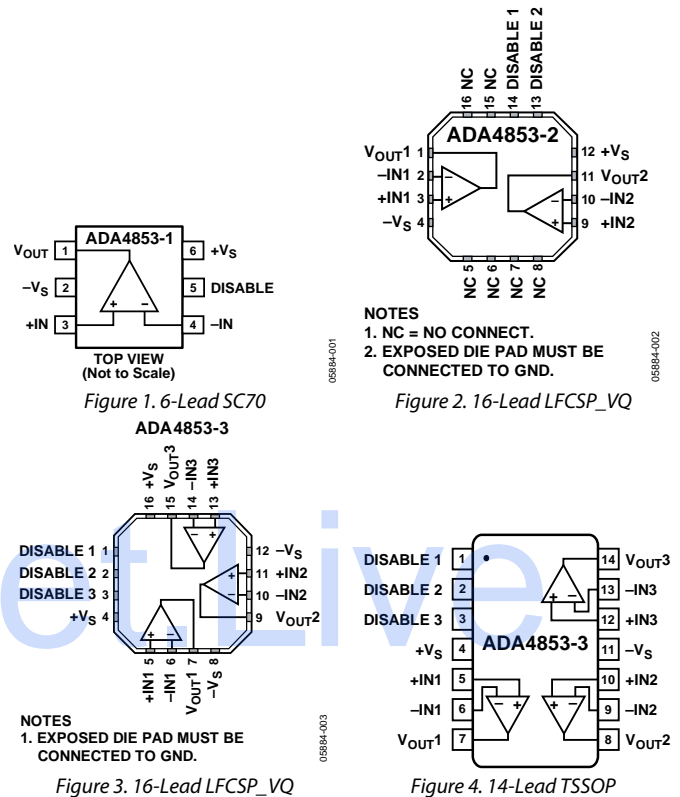

The ADA4853-1 is available in a 6-lead SC70, the ADA4853-2 is available in a 16-lead LFCSP_VQ, and the ADA4853-3 is available in both a 16-lead LFCSP_VQ and a 14-lead TSSOP. The ADA4853-1 temperature range is -40°C to $+85^{\circ}\text{C}$ while the ADA4853-2/ADA4853-3 temperature range is -40°C to $+105^{\circ}\text{C}$.

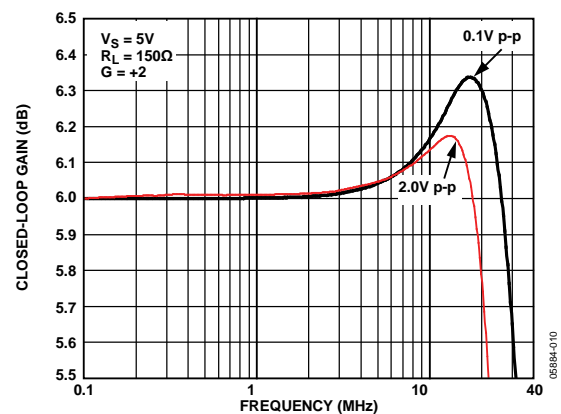

IMPORTANT LINKS for the [ADA4853-1](#) [4853-2](#) [4853-3](#)*

Last content update 08/26/2013 12:56 pm

DOCUMENTATION

AN-581: Biasing and Decoupling Op Amps in Single Supply Apps

AN-402: Replacing Output Clamping Op Amps with Input Clamping Amps

AN-417: Fast Rail-to-Rail Operational Amplifiers Ease Design Constraints in Low Voltage High Speed Systems

MT-060: Choosing Between Voltage Feedback and Current Feedback Op Amps

MT-059: Compensating for the Effects of Input Capacitance on VFB and CFB Op Amps Used in Current-to-Voltage Converters

MT-058: Effects of Feedback Capacitance on VFB and CFB Op Amps

MT-056: High Speed Voltage Feedback Op Amps

MT-053: Op Amp Distortion: HD, THD, THD + N, IMD, SFDR, MTPR

MT-052: Op Amp Noise Figure: Don't Be Mislead

MT-050: Op Amp Total Output Noise Calculations for Second-Order System

MT-049: Op Amp Total Output Noise Calculations for Single-Pole System

MT-048: Op Amp Noise Relationships: 1/f Noise, RMS Noise, and Equivalent Noise Bandwidth

MT-047: Op Amp Noise

MT-033: Voltage Feedback Op Amp Gain and Bandwidth

MT-032: Ideal Voltage Feedback (VFB) Op Amp

A Stress-Free Method for Choosing High-Speed Op Amps

Low-Cost Video Multiplexing Using High-Speed Amplifier

Video Amplifier Products (April 2007)

FOR THE ADA4853-1:

UG-112: Universal Evaluation Board for Single, High Speed Op Amps Offered in SC-70 Packages

We measure portable performance in microA and MHz. In handheld designs, analog is everywhere.

FOR THE ADA4853-2:

AN-1240: Low Cost Video Multiplexer for Video Switching Using the ADA4853-2 Op Amp with Disable Function

UG-017: Universal Evaluation Board for Dual High Speed Op Amps Offered in 16-Lead 3 mm x 3 mm LFCSP

FOR THE ADA4853-3:

UG-025: Evaluation Board User Guide

UG-026: Evaluation Board User Guide

SAMPLE & BUY

ADA4853-1

ADA4853-2

ADA4853-3

PARAMETRIC SELECTION TABLES

Find Similar Products By Operating Parameters

High Speed Amplifiers Selection Table

DESIGN TOOLS, MODELS, DRIVERS & SOFTWARE

dBm/dBu/dBv Calculator

Power Dissipation vs Die Temp

Analog Filter Wizard 2.0

ADIsimOpAmp™

OpAmp Stability

ADA4853 SPICE Macro Model

EVALUATION KITS & SYMBOLS & FOOTPRINTS

View the Evaluation Boards and Kits page for the ADA4853-1

View the Evaluation Boards and Kits page for the ADA4853-2

View the Evaluation Boards and Kits page for the ADA4853-3

Symbols and Footprints for the ADA4853-1

Symbols and Footprints for the ADA4853-2

Symbols and Footprints for the ADA4853-3

DESIGN COLLABORATION COMMUNITY



[Collaborate Online](#) with the ADI support team and other designers

Follow us on Twitter: www.twitter.com/ADI_News

Like us on Facebook: www.facebook.com/AnalogDevicesInc

DESIGN SUPPORT

Submit your support request here:

[Linear and Data Converters](#)

[Embedded Processing and DSP](#)

Telephone our Customer Interaction Centers toll free:

Americas: 1-800-262-5643

Europe: 00800-266-822-82

China: 4006-100-006

India: 1800-419-0108

Russia: 8-800-555-45-90

[Quality and Reliability](#)

[Lead\(Pb\)-Free Data](#)

* This page was dynamically generated by Analog Devices, Inc. and inserted into this data sheet.
Note: Dynamic changes to the content on this page (labeled 'Important Links') does not constitute a change to the revision number of the product data sheet.
This content may be frequently modified.

TABLE OF CONTENTS

Features	1	Typical Performance Characteristics	8
Applications.....	1	Circuit Description.....	16
Pin Configurations	1	Headroom Considerations.....	16
General Description	1	Overload Behavior and Recovery	16
Revision History	2	Applications Information	17
Specifications.....	3	Single-Supply Video Amplifier.....	17
Specifications with 3 V Supply	3	Power Supply Bypassing	17
Specifications with 5 V Supply	5	Layout	17
Absolute Maximum Ratings.....	7	Outline Dimensions	18
Thermal Resistance	7	Ordering Guide	19
ESD Caution.....	7	Automotive Products.....	19

REVISION HISTORY

1/11—Rev. E to Rev. F

Changes to Features Section, Applications Section, and General Description Section	1
Changed Pin 5 to DISABLE in Figure 1	1
Changed Pin 13 to DISABLE 2 and Pin 14 and DISABLE 1 in Figure 2	1
Changes to Table 1	3
Changes to Table 2.....	5
Changes to Ordering Guide	18
Added Automotive Products Section.....	18

9/10—Rev. D to Rev. E

Changes to Figure 2 and Figure 3	1
--	---

6/10—Rev. C to Rev. D

Changes to Figure 2 and Figure 3	1
Changes to Outline Dimensions.....	16

10/07—Rev. B to Rev. C

Changes to Applications Section	1
Changes to Ordering Guide	16

10/06—Rev. A to Rev. B

Added ADA4853-3.....	Universal
Added 16-Lead LFCSP_VQ	Universal
Added 14-Lead TSSOP	Universal
Changes to Features.....	1
Changes to DC Performance, Input Characteristics, and Power Supply Sections	3
Changes to DC Performance, Input Characteristics, and Power Supply Sections	4
Changes to Figure 20.....	8
Changes to Figure 49.....	13
Updated Outline Dimensions	16
Changes to Ordering Guide	16

7/06—Rev. 0 to Rev. A

Added ADA4853-2.....	Universal
Changes to Features and General Description	1
Changes to Table 1.....	3
Changes to Table 2.....	4
Changes to Table 3.....	5
Changes to Figure 7.....	6
Changes to Figure 11 Caption, Figure 12, Figure 13, and Figure 16.....	7
Changes to Figure 17 and Figure 19	8
Inserted Figure 21; Renumbered Sequentially	8
Inserted Figure 25; Renumbered Sequentially	9
Changes to Figure 28.....	9
Changes to Figure 31 through Figure 35.....	10
Changes to Figure 37, Figure 39 through Figure 42	11
Inserted Figure 43 and Figure 46.....	12
Inserted Figure 47.....	13
Changes to Circuit Description Section	13
Changes to Headroom Considerations Section	13
Changes to Figure 48.....	14
Updated Outline Dimensions.....	15
Changes to Ordering Guide	15

1/06—Revision 0: Initial Version

SPECIFICATIONS

SPECIFICATIONS WITH 3 V SUPPLY

$T_A = 25^\circ\text{C}$, $R_F = 1\text{ k}\Omega$, $R_G = 1\text{ k}\Omega$ for $G = +2$, $R_L = 150\ \Omega$, unless otherwise noted.

Table 1.

Parameter	Conditions	Min	Typ	Max	Unit
DYNAMIC PERFORMANCE					
-3 dB Bandwidth	$G = +1, V_O = 0.1\text{ V p-p}$		90		MHz
	$G = +2, V_O = 2\text{ V p-p}$		32		MHz
Bandwidth for 0.5 dB Flatness	$G = +2, V_O = 2\text{ V p-p}, R_L = 150\ \Omega$		22		MHz
Settling Time to 0.1%	$V_O = 2\text{ V step}$		45		ns
Slew Rate	$G = +2, V_O = 2\text{ V step}$	88	100		V/ μs
	ADA4853-3W only: T_{MIN} to T_{MAX}	60			V/ μs
NOISE/DISTORTION PERFORMANCE					
Differential Gain	$R_L = 150\ \Omega$		0.20		%
Differential Phase	$R_L = 150\ \Omega$		0.10		Degrees
Input Voltage Noise	$f = 100\text{ kHz}$		22		nV/ $\sqrt{\text{Hz}}$
Input Current Noise	$f = 100\text{ kHz}$		2.2		pA/ $\sqrt{\text{Hz}}$
Crosstalk	$G = +2, V_O = 2\text{ V p-p}, R_L = 150\ \Omega, f = 5\text{ MHz}$		-66		dB
DC PERFORMANCE					
Input Offset Voltage			1	4.0	mV
	ADA4853-3W only: T_{MIN} to T_{MAX}			6.0	mV
Input Offset Voltage Drift			1.6		$\mu\text{V}/^\circ\text{C}$
Input Bias Current			1.0	1.7	μA
	ADA4853-3W only: T_{MIN} to T_{MAX}			1.7	μA
Input Bias Current Drift			4		nA/ $^\circ\text{C}$
Input Bias Offset Current			50		nA
Open-Loop Gain	$V_O = 0.5\text{ V to }2.5\text{ V}$	72	80		dB
	ADA4853-3W only: T_{MIN} to T_{MAX}	69			dB
INPUT CHARACTERISTICS					
Input Resistance	Differential/common mode		0.5/20		M Ω
Input Capacitance			0.6		pF
Input Common-Mode Voltage Range			-0.2 to $+V_{\text{CC}} - 1.2$		V
Input Overdrive Recovery Time (Rise/Fall)	$V_{\text{IN}} = -0.5\text{ V to }+3.5\text{ V}, G = +1$		40		ns
Common-Mode Rejection Ratio	$V_{\text{CM}} = 0\text{ V to }1\text{ V}$	-69	-85		dB
	ADA4853-3W only: T_{MIN} to T_{MAX}	-66			dB
DISABLE					
DISABLE Input Voltage			1.2		V
Turn-Off Time			1.4		μs
Turn-On Time			120		ns
DISABLE Bias Current					
Enabled	DISABLE = 3.0 V		25	30	μA
	DISABLE = 3.0 V, ADA4853-3W only: T_{MIN} to T_{MAX}			30	μA
Disabled	DISABLE = 0 V		0.01		μA
OUTPUT CHARACTERISTICS					
Output Overdrive Recovery Time	$V_{\text{IN}} = -0.25\text{ V to }+1.75\text{ V}, G = +2$		70		ns
Output Voltage Swing	$R_L = 150\ \Omega$	0.3 to 2.7	0.15 to 2.88		V
	$R_L = 150\ \Omega$, ADA4853-3W only: T_{MIN} to T_{MAX}	0.3 to 2.7			V
Short-Circuit Current	Sinking/sourcing		150/120		mA

ADA4853-1/ADA4853-2/ADA4853-3

Parameter	Conditions	Min	Typ	Max	Unit
POWER SUPPLY					
Operating Range		2.65		5	V
Quiescent Current/Amplifier			1.3	1.6	mA
	ADA4853-3W only: T_{MIN} to T_{MAX}			1.6	mA
Quiescent Current (Disabled)/Amplifier	DISABLE = 0 V		0.1	1.5	μ A
	DISABLE = 0 V, ADA4853-3W only: T_{MIN} to T_{MAX}			1.5	μ A
Positive Power Supply Rejection	$+V_S = +1.5$ V to $+2.5$ V, $-V_S = -1.5$ V	-76	-86		dB
	ADA4853-3W only: T_{MIN} to T_{MAX}	-76			dB
Negative Power Supply Rejection	$-V_S = -1.5$ V to -2.5 V, $+V_S = +1.5$ V	-77	-88		dB
	ADA4853-3W only: T_{MIN} to T_{MAX}	-74			dB

SPECIFICATIONS WITH 5 V SUPPLY

$T_A = 25^\circ\text{C}$, $R_F = 1\text{ k}\Omega$, $R_G = 1\text{ k}\Omega$ for $G = +2$, $R_L = 150\ \Omega$, unless otherwise noted.

Table 2.

Parameter	Conditions	Min	Typ	Max	Unit
DYNAMIC PERFORMANCE					
-3 dB Bandwidth	$G = +1, V_O = 0.1\text{ V p-p}$		100		MHz
	$G = +2, V_O = 2\text{ V p-p}$		35		MHz
Bandwidth for 0.5 dB Flatness	$G = +2, V_O = 2\text{ V p-p}$		22		MHz
Settling Time to 0.1%	$V_O = 2\text{ V step}$		54		ns
Slew Rate	$G = +2, V_O = 2\text{ V step}$	93	120		V/ μs
	ADA4853-3W only: T_{MIN} to T_{MAX}	70			V/ μs
NOISE/DISTORTION PERFORMANCE					
Differential Gain	$R_L = 150\ \Omega$		0.22		%
Differential Phase	$R_L = 150\ \Omega$		0.10		Degrees
Input Voltage Noise	$f = 100\text{ kHz}$		22		nV/ $\sqrt{\text{Hz}}$
Input Current Noise	$f = 100\text{ kHz}$		2.2		pA/ $\sqrt{\text{Hz}}$
Crosstalk	$G = +2, V_O = 2\text{ V p-p}, R_L = 150\ \Omega, f = 5\text{ MHz}$		-66		dB
DC PERFORMANCE					
Input Offset Voltage			1	4.1	mV
	ADA4853-3W only: T_{MIN} to T_{MAX}			6.0	mV
Input Offset Voltage Drift			1.6		$\mu\text{V}/^\circ\text{C}$
Input Bias Current			1.0	1.7	μA
	ADA4853-3W only: T_{MIN} to T_{MAX}			1.7	μA
Input Bias Current Drift			4		nA/ $^\circ\text{C}$
Input Bias Offset Current			60		nA
Open-Loop Gain	$V_O = 0.5\text{ V to }4.5\text{ V}$	72	80		dB
	ADA4853-3W only: T_{MIN} to T_{MAX}	70			dB
INPUT CHARACTERISTICS					
Input Resistance	Differential/common mode		0.5/20		M Ω
Input Capacitance			0.6		pF
Input Common-Mode Voltage Range			-0.2 to $+V_{\text{CC}} - 1.2$		V
Input Overdrive Recovery Time (Rise/Fall)	$V_{\text{IN}} = -0.5\text{ V to }+5.5\text{ V}, G = +1$		40		ns
Common-Mode Rejection Ratio	$V_{\text{CM}} = 0\text{ V to }3\text{ V}$	-71	-88		dB
	ADA4853-3W only: T_{MIN} to T_{MAX}	-68			dB
DISABLE					
DISABLE Input Voltage			1.2		V
Turn-Off Time			1.5		μs
Turn-On Time			120		ns
DISABLE Bias Current Enabled	DISABLE = 5 V		40	50	μA
	DISABLE = 5 V, ADA4853-3W only: T_{MIN} to T_{MAX}			50	μA
Disabled	DISABLE = 0 V		0.01		μA
OUTPUT CHARACTERISTICS					
Output Overdrive Recovery Time	$V_{\text{IN}} = -0.25\text{ V to }+2.75\text{ V}, G = +2$		55		ns
Output Voltage Swing	$R_L = 75\ \Omega$	0.55 to 4.5	0.1 to 4.8		V
	$R_L = 75\ \Omega$, ADA4853-3W only: T_{MIN} to T_{MAX}	0.55 to 4.5			V
Short-Circuit Current	Sinking/sourcing		160/120		mA

ADA4853-1/ADA4853-2/ADA4853-3

Parameter	Conditions	Min	Typ	Max	Unit
POWER SUPPLY					
Operating Range		2.65		5	V
Quiescent Current/Amplifier			1.4	1.8	mA
Quiescent Current (Disabled)/Amplifier	ADA4853-3W only: T_{MIN} to T_{MAX}			1.8	mA
	DISABLE = 0 V		0.1	1.5	μ A
Positive Power Supply Rejection	DISABLE = 0 V, ADA4853-3W only: T_{MIN} to T_{MAX}			1.5	μ A
	$+V_S = +2.5$ V to $+3.5$ V, $-V_S = -2.5$ V	-75	-80		dB
Negative Power Supply Rejection	ADA4853-3W only: T_{MIN} to T_{MAX}	-72			
	$-V_S = -2.5$ V to -3.5 V, $+V_S = +2.5$ V	-75	-80		dB
	ADA4853-3W only: T_{MIN} to T_{MAX}	-72			dB

ABSOLUTE MAXIMUM RATINGS

Table 3.

Parameter	Rating
Supply Voltage	5.5 V
Power Dissipation	See Figure 6
Common-Mode Input Voltage	$-V_S - 0.2\text{ V}$ to $+V_S - 1.2\text{ V}$
Differential Input Voltage	$\pm V_S$
Storage Temperature Range	-65°C to $+125^\circ\text{C}$
Operating Temperature Range	
6-Lead SC70	-40°C to $+85^\circ\text{C}$
16-Lead LFCSP_VQ	-40°C to $+105^\circ\text{C}$
14-Lead TSSOP	-40°C to $+105^\circ\text{C}$
Lead Temperature	JEDEC J-STD-20
Junction Temperature	150°C

Stresses above those listed under Absolute Maximum Ratings may cause permanent damage to the device. This is a stress rating only; functional operation of the device at these or any other conditions above those indicated in the operational section of this specification is not implied. Exposure to absolute maximum rating conditions for extended periods may affect device reliability.

THERMAL RESISTANCE

θ_{JA} is specified for the worst-case conditions, that is, θ_{JA} is specified for the device soldered in the circuit board for surface-mount packages.

Table 4.

Package Type	θ_{JA}	Unit
6-Lead SC70	430	$^\circ\text{C}/\text{W}$
16-Lead LFCSP_VQ	63	$^\circ\text{C}/\text{W}$
14-Lead TSSOP	120	$^\circ\text{C}/\text{W}$

Maximum Power Dissipation

The maximum safe power dissipation for the ADA4853-1/ADA4853-2/ADA4853-3 is limited by the associated rise in junction temperature (T_J) on the die. At approximately 150°C , which is the glass transition temperature, the plastic changes its properties. Even temporarily exceeding this temperature limit can change the stresses that the package exerts on the die, permanently shifting the parametric performance of the amplifiers. Exceeding a junction temperature of 150°C for an extended period can result in changes in silicon devices, potentially causing degradation or loss of functionality.

The power dissipated in the package (P_D) for a sine wave and a resistor load is the total power consumed from the supply minus the load power.

$$P_D = \text{Total Power Consumed} - \text{Load Power}$$

$$P_D = \left(V_{\text{SUPPLY VOLTAGE}} \times I_{\text{SUPPLY CURRENT}} \right) - \frac{V_{\text{OUT}}^2}{R_L}$$

RMS output voltages should be considered.

Airflow increases heat dissipation, effectively reducing θ_{JA} . In addition, more metal directly in contact with the package leads and through holes under the device reduces θ_{JA} .

Figure 6 shows the maximum safe power dissipation in the package vs. the ambient temperature for the 6-lead SC70 ($430^\circ\text{C}/\text{W}$), the 14-lead TSSOP ($120^\circ\text{C}/\text{W}$), and the 16-lead LFCSP_VQ ($63^\circ\text{C}/\text{W}$) on a JEDEC standard 4-layer board. θ_{JA} values are approximations.

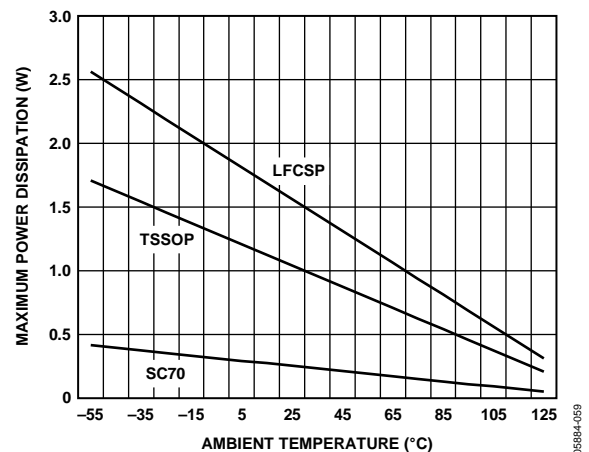

Figure 6. Maximum Power Dissipation vs. Temperature for a 4-Layer Board

ESD CAUTION



ESD (electrostatic discharge) sensitive device. Charged devices and circuit boards can discharge without detection. Although this product features patented or proprietary protection circuitry, damage may occur on devices subjected to high energy ESD. Therefore, proper ESD precautions should be taken to avoid performance degradation or loss of functionality.

TYPICAL PERFORMANCE CHARACTERISTICS

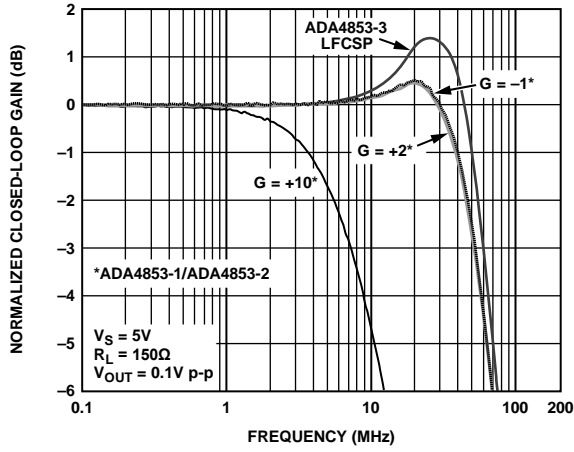

Figure 7. Small Signal Frequency Response for Various Gains

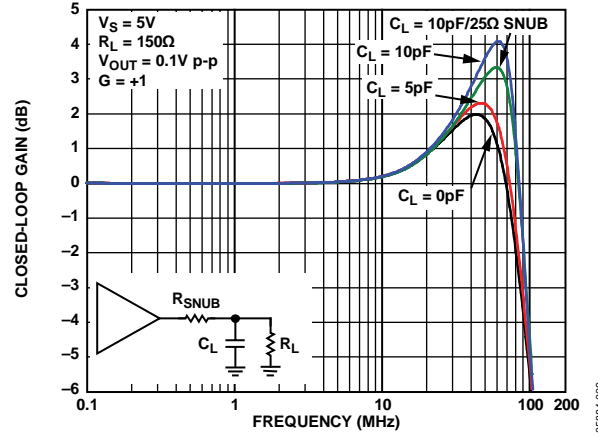

Figure 10. Small Signal Frequency Response for Various Capacitive Loads

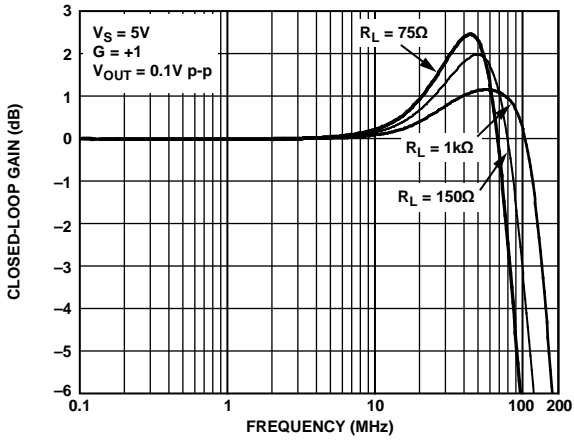

Figure 8. Small Signal Frequency Response for Various Loads

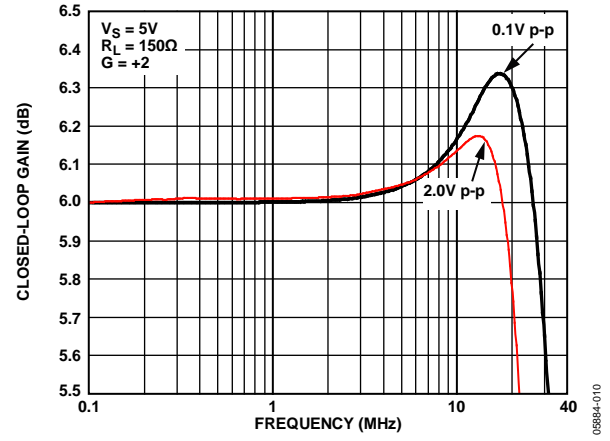

Figure 11. 0.5 dB Flatness Response for Various Output Voltages

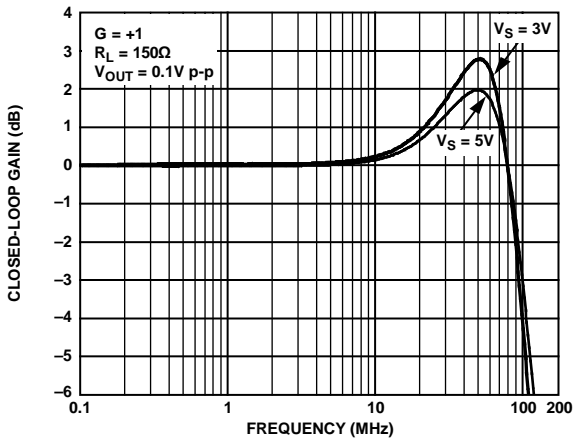

Figure 9. Small Signal Frequency Response for Various Supplies

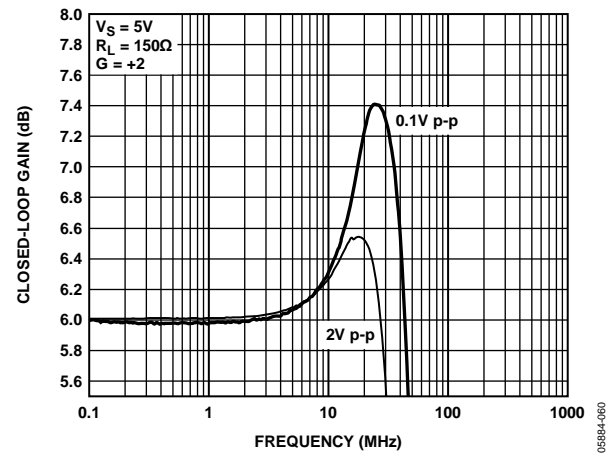

Figure 12. ADA4853-3 LFCSP_VQ Flatness Response for Various Output Voltages

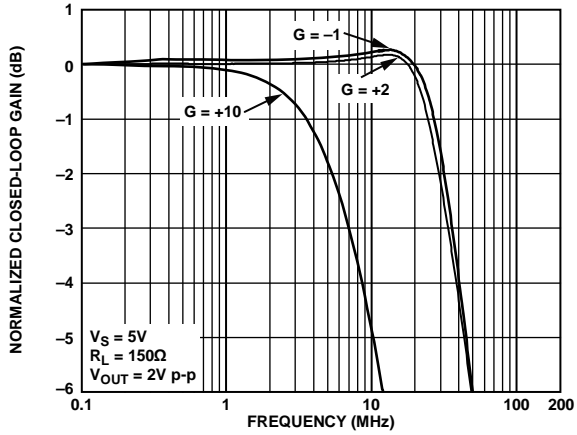

Figure 13. Large Signal Frequency Response for Various Gains

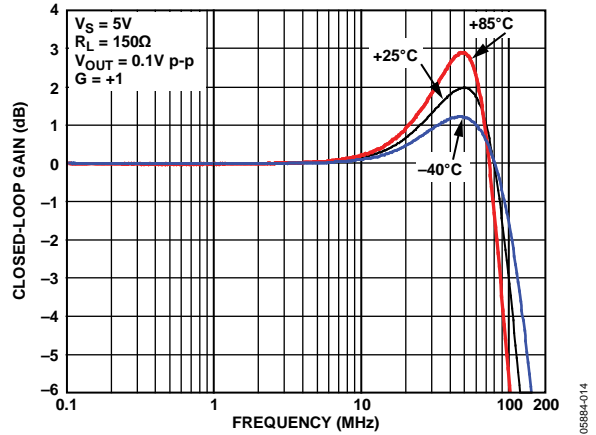

Figure 16. Small Signal Frequency Response for Various Temperatures

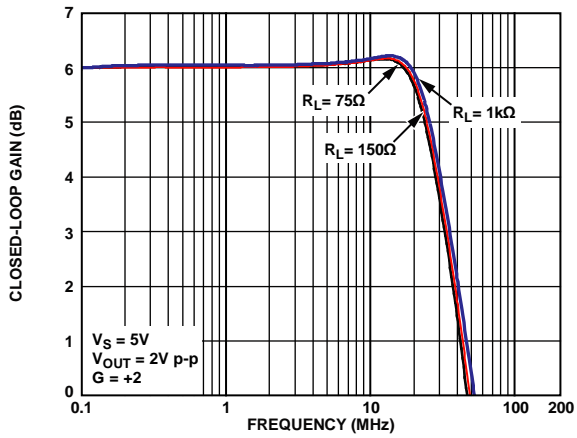

Figure 14. Large Signal Frequency Response for Various Loads

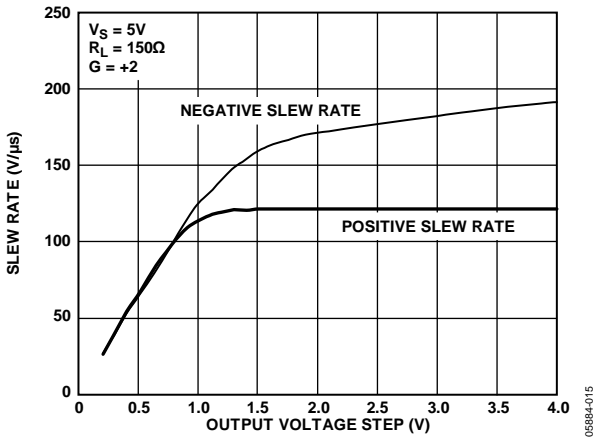

Figure 17. Slew Rate vs. Output Voltage

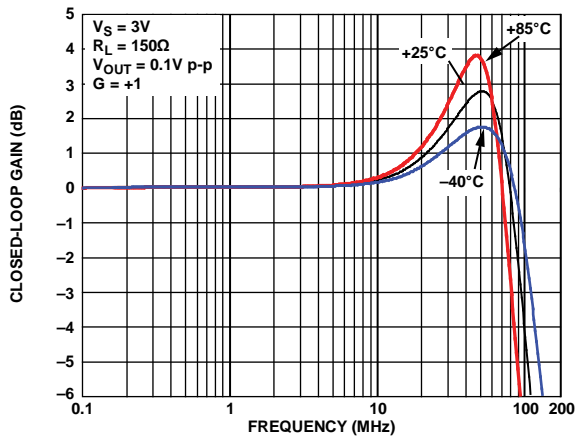

Figure 15. Small Signal Frequency Response for Various Temperatures

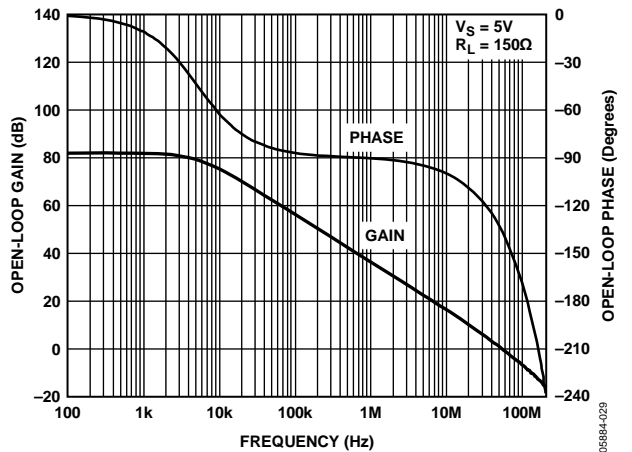

Figure 18. Open-Loop Gain and Phase vs. Frequency

ADA4853-1/ADA4853-2/ADA4853-3

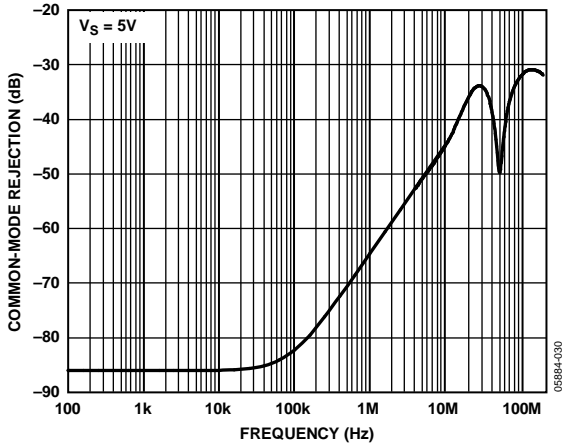

Figure 19. Common-Mode Rejection vs. Frequency

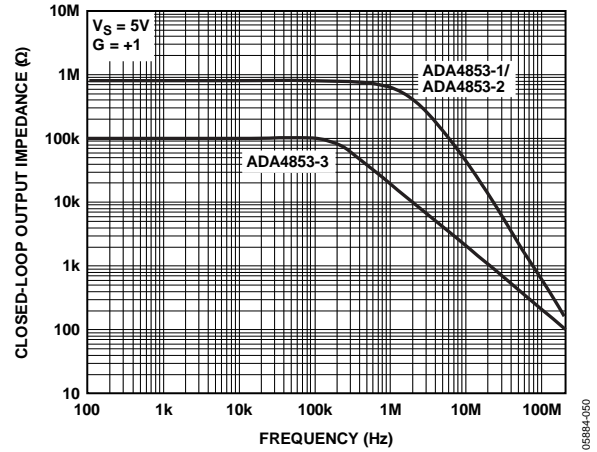

Figure 22. Output Impedance vs. Frequency Disabled

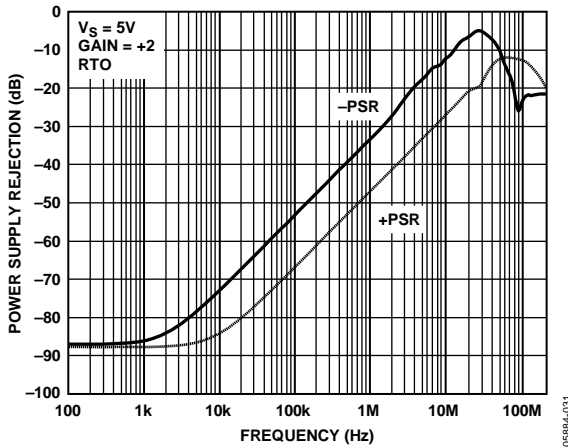

Figure 20. Power Supply Rejection vs. Frequency

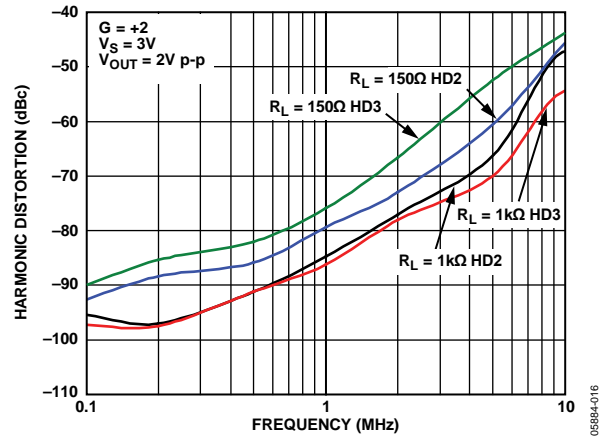

Figure 23. Harmonic Distortion vs. Frequency

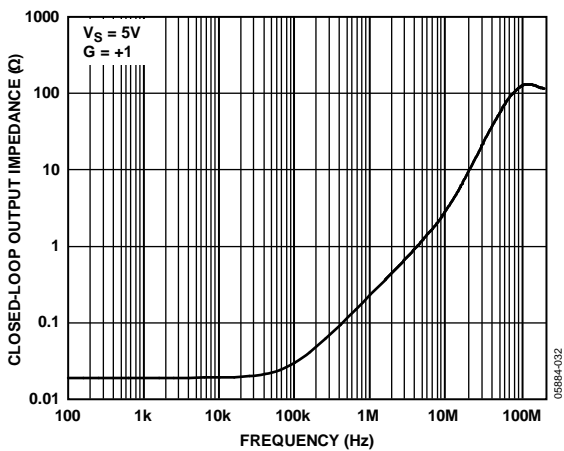

Figure 21. Output Impedance vs. Frequency Enabled

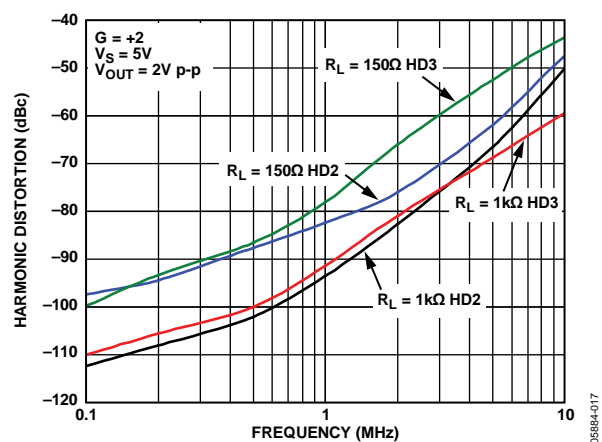

Figure 24. Harmonic Distortion vs. Frequency

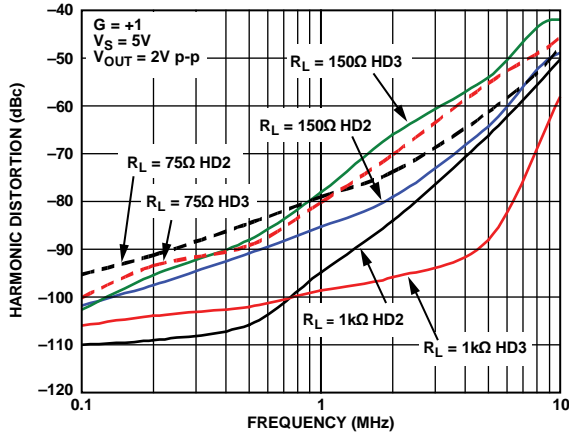

Figure 25. Harmonic Distortion vs. Frequency

05984-018

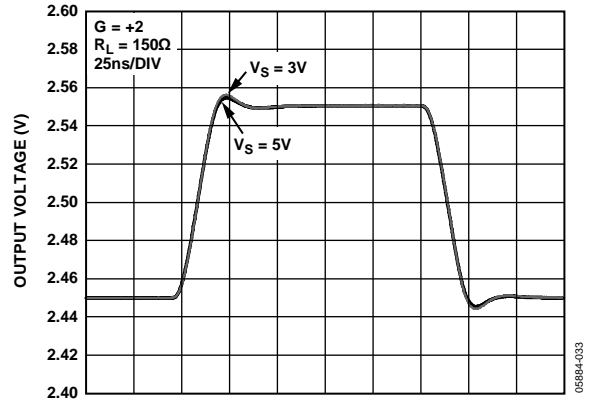

Figure 28. Small Signal Pulse Response for Various Supplies

05984-033

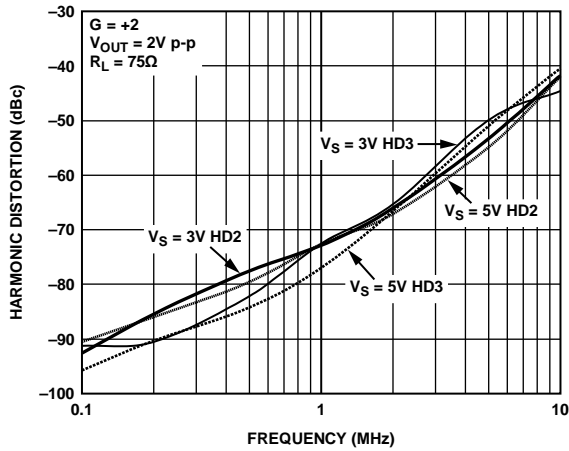

Figure 26. Harmonic Distortion vs. Frequency

05984-051

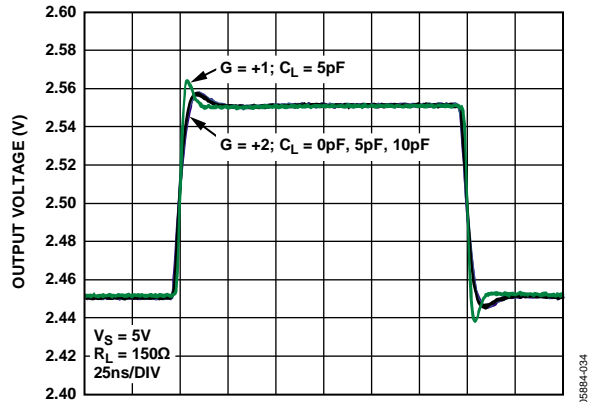

Figure 29. Small Signal Pulse Response for Various Capacitive Loads

05984-034

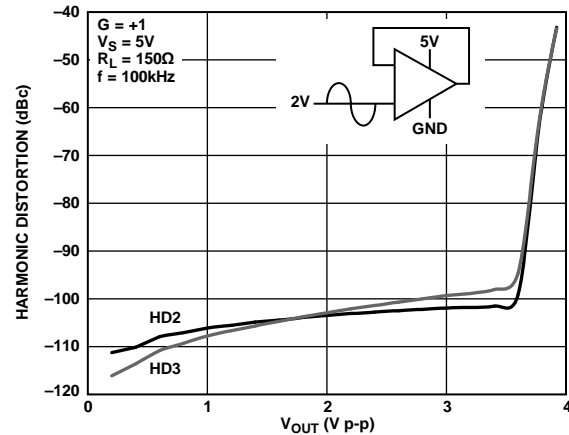

Figure 27. Harmonic Distortion for Various Output Voltages

05984-019

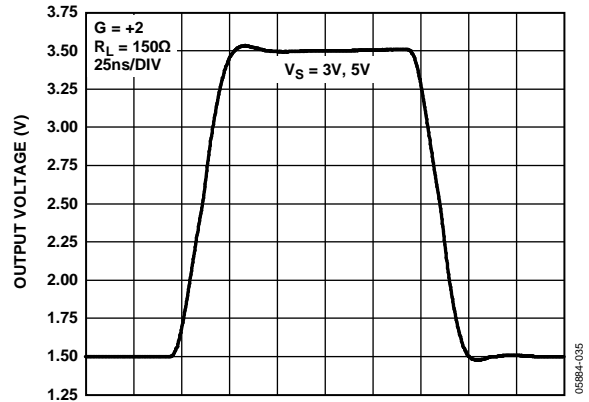

Figure 30. Large Signal Pulse Response for Various Supplies

05984-035

ADA4853-1/ADA4853-2/ADA4853-3

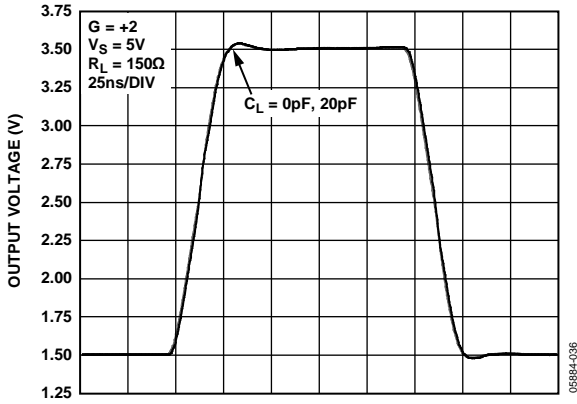

Figure 31. Large Signal Pulse Response for Various Capacitive Loads

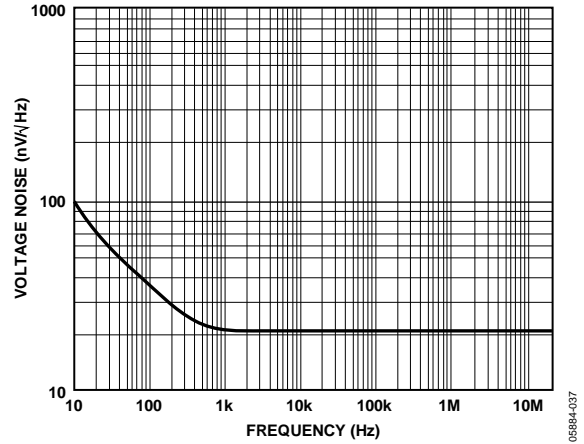

Figure 34. Voltage Noise vs. Frequency

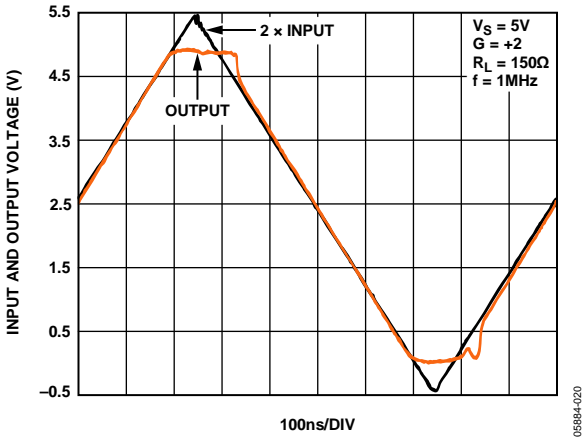

Figure 32. Output Overdrive Recovery

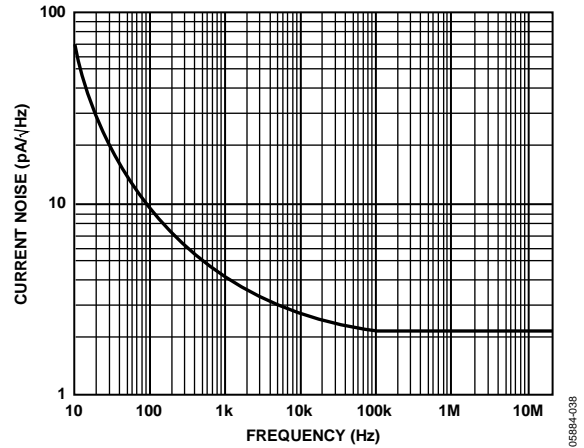

Figure 35. Current Noise vs. Frequency

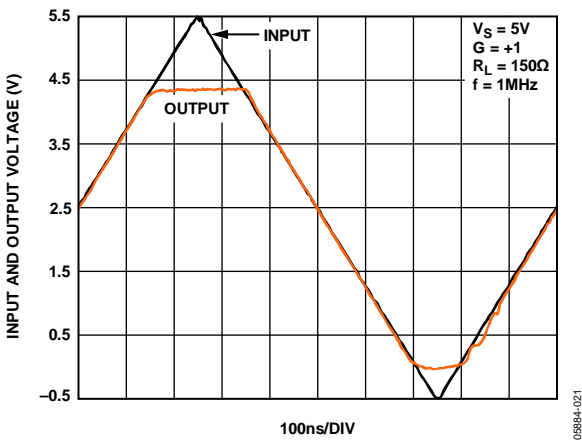

Figure 33. Input Overdrive Recovery

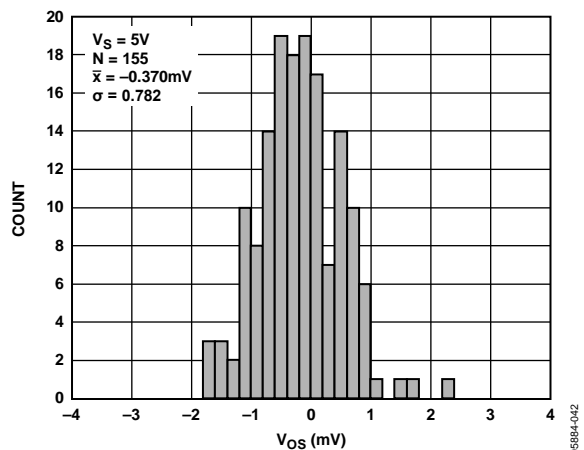

Figure 36. V_{OS} Distribution

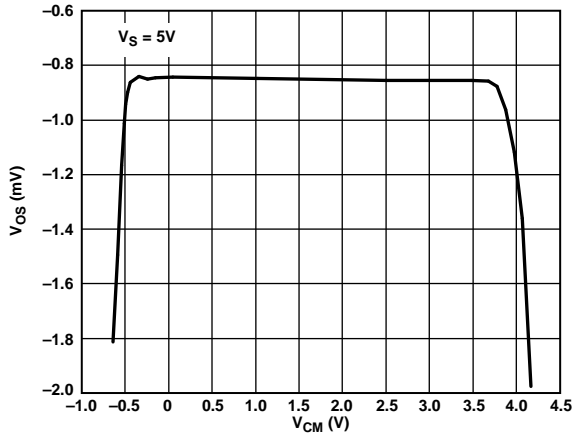

Figure 37. V_{OS} vs. Common-Mode Voltage

05884-022

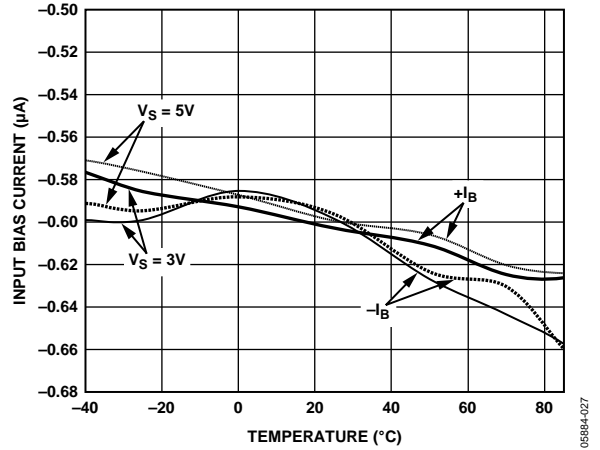

Figure 40. Input Bias Current vs. Temperature

05884-027

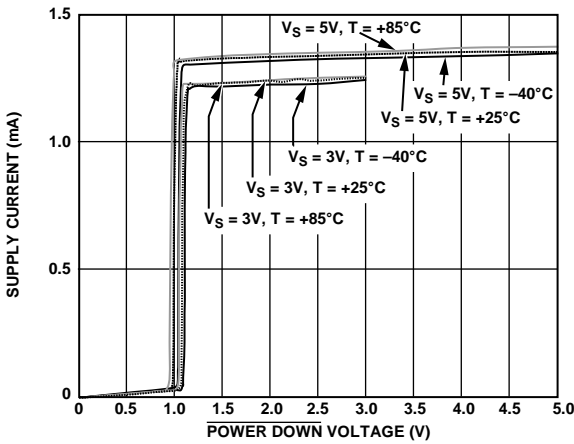

Figure 38. Supply Current vs. POWER DOWN Voltage

05884-023

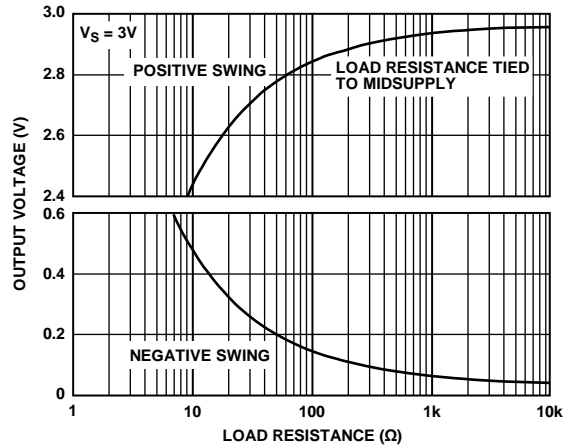

Figure 41. Output Voltage vs. Load Resistance

05884-039

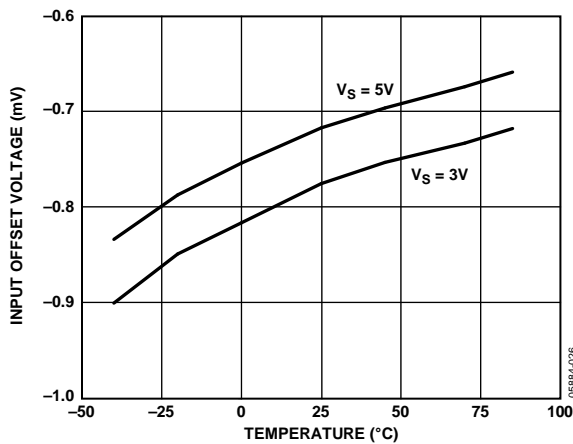

Figure 39. Input Offset Voltage vs. Temperature

05884-026

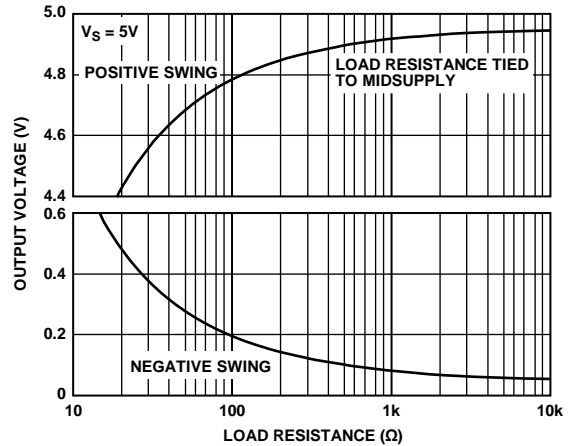

Figure 42. Output Voltage vs. Load Resistance

05884-040

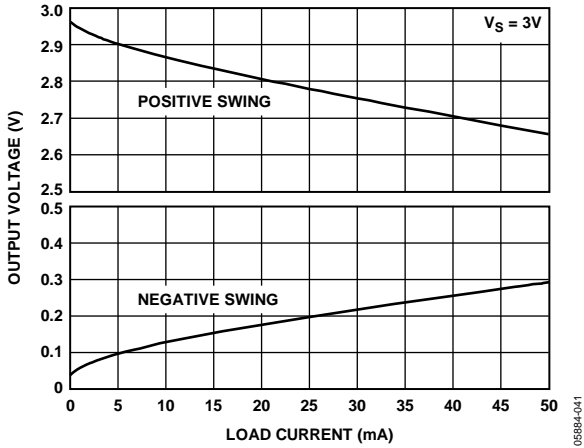

Figure 43. Output Voltage vs. Load Current

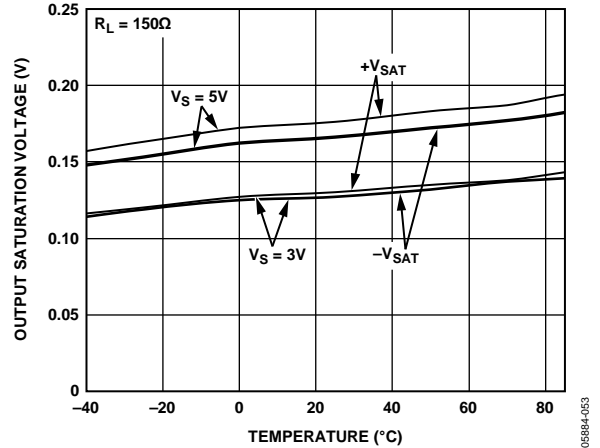

Figure 45. Output Saturation Voltage vs. Temperature for Various Supplies

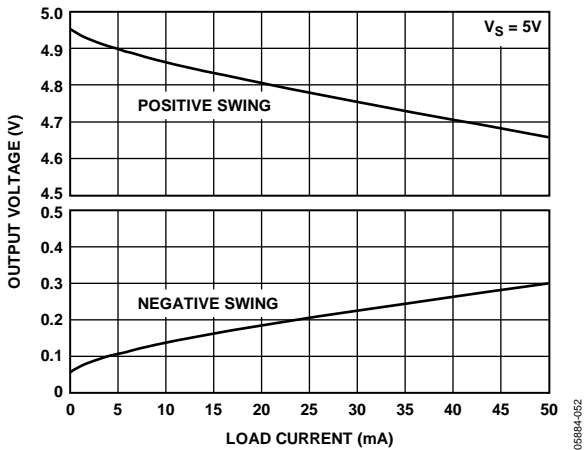

Figure 44. Output Voltage vs. Load Current

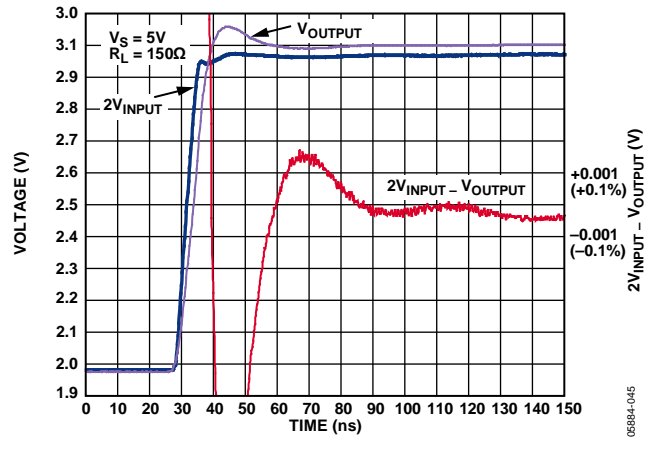

Figure 46. 0.1% Settling Time

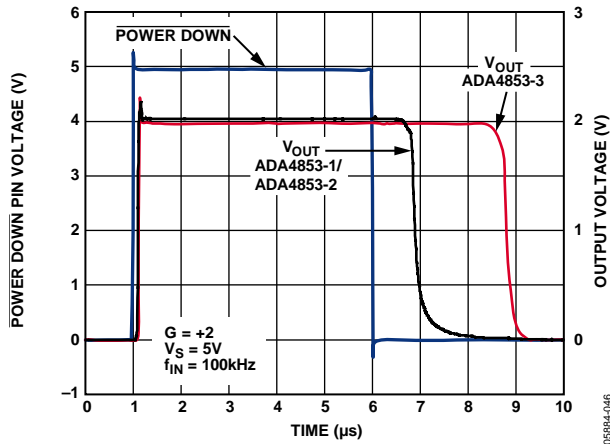

Figure 47. Enable/Disable Time

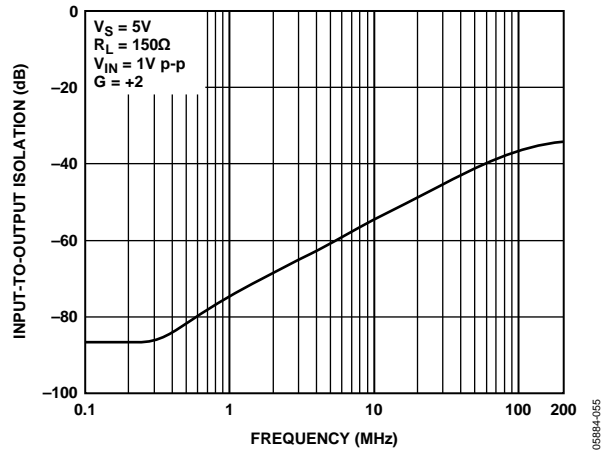

Figure 49. Input-to-Output Isolation, Chip Disabled

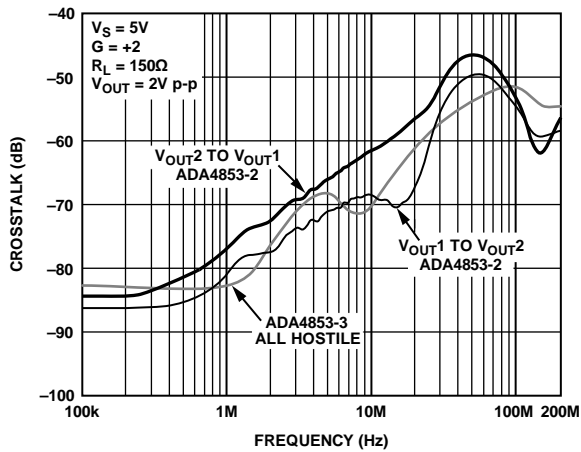

Figure 48. Crosstalk vs. Frequency

ADA4853-1/ADA4853-2/ADA4853-3

CIRCUIT DESCRIPTION

The ADA4853-1/ADA4853-2/ADA4853-3 feature a high slew rate input stage that is a true single-supply topology capable of sensing signals at or below the minus supply rail. The rail-to-rail output stage can pull within 100 mV of either supply rail when driving light loads and within 200 mV when driving 150 Ω . High speed performance is maintained at supply voltages as low as 2.65 V.

HEADROOM CONSIDERATIONS

The ADA4853-1/ADA4853-2/ADA4853-3 are designed for use in low voltage systems. To obtain optimum performance, it is useful to understand the behavior of the amplifiers as input and output signals approach their headroom limits. The input common-mode voltage range of the amplifier extends from the negative supply voltage (actually 200 mV below this) to within 1.2 V of the positive supply voltage.

Exceeding the headroom limits is not a concern for any inverting gain on any supply voltage, as long as the reference voltage at the positive input of the amplifier lies within the input common-mode range of the amplifier.

The input stage is the headroom limit for signals approaching the positive rail. Figure 50 shows a typical offset voltage vs. the input common-mode voltage for the ADA4853-1/ADA4853-2/ADA4853-3 on a 5 V supply. Accurate dc performance is maintained from approximately 200 mV below the negative supply to within 1.2 V of the positive supply. For high speed signals, however, there are other considerations. As the common-mode voltage gets within 1.2 V of positive supply, the amplifier responds well but the bandwidth begins to drop as the common-mode voltage approaches the positive supply. This can manifest itself in increased distortion or settling time. Higher frequency signals require more headroom than the lower frequencies to maintain distortion performance.

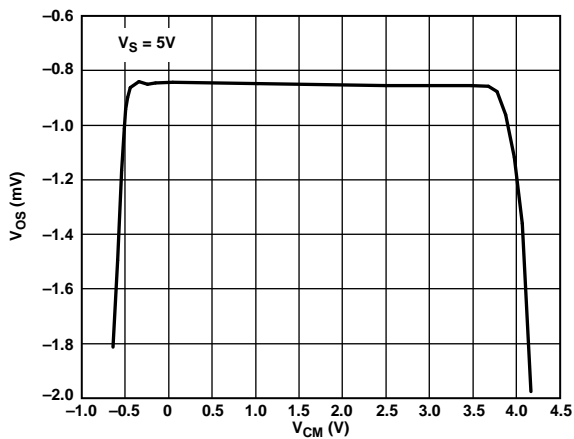

Figure 50. V_{OS} vs. Common-Mode Voltage, $V_S = 5$ V

For signals approaching the negative supply, inverting gain, and high positive gain configurations, the headroom limit is the output stage. The ADA4853-1/ADA4853-2/ADA4853-3 use a common-emitter output stage. This output stage maximizes the available output range, limited by the saturation voltage of the output transistors. The saturation voltage increases with the drive current that the output transistor is required to supply due to the collector resistance of the output transistor.

As the saturation point of the output stage is approached, the output signal shows increasing amounts of compression and clipping. For the input headroom case, higher frequency signals require a bit more headroom than the lower frequency signals. Figure 27 illustrates this point by plotting the typical distortion vs. the output amplitude.

OVERLOAD BEHAVIOR AND RECOVERY

Input

The specified input common-mode voltage of the ADA4853-1/ADA4853-2/ADA4853-3 is 200 mV below the negative supply to within 1.2 V of the positive supply. Exceeding the top limit results in lower bandwidth and increased rise time. Pushing the input voltage of a unity-gain follower to less than 1.2 V from the positive supply leads to an increasing amount of output error as well as increased settling time. The recovery time from input voltages 1.2 V or closer to the positive supply is approximately 40 ns; this is limited by the settling artifacts caused by transistors in the input stage coming out of saturation.

The amplifiers do not exhibit phase reversal, even for input voltages beyond the voltage supply rails. Going more than 0.6 V beyond the power supplies turns on protection diodes at the input stage, greatly increasing the current draw of the devices.

APPLICATIONS INFORMATION

SINGLE-SUPPLY VIDEO AMPLIFIER

With low differential gain and phase errors and wide 0.5 dB flatness, the ADA4853-1/ADA4853-2/ADA4853-3 are ideal solutions for portable video applications. Figure 51 shows a typical video driver set for a noninverting gain of +2, where $R_F = R_G = 1\text{ k}\Omega$. The video amplifier input is terminated into a shunt $75\ \Omega$ resistor. At the output, the amplifier has a series $75\ \Omega$ resistor for impedance matching to the video load.

When operating in low voltage, single-supply applications, the input signal is only limited by the input stage headroom.

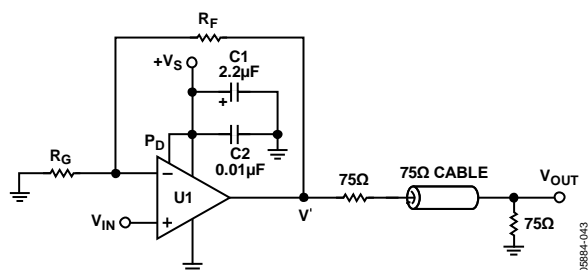

Figure 51. Video Amplifier

POWER SUPPLY BYPASSING

Attention must be paid to bypassing the power supply pins of the ADA4853-1/ADA4853-2/ADA4853-3. High quality capacitors with low equivalent series resistance (ESR), such as multilayer ceramic capacitors (MLCCs), should be used to minimize supply voltage ripple and power dissipation. A large, usually tantalum, $2.2\ \mu\text{F}$ to $47\ \mu\text{F}$ capacitor located in proximity to the ADA4853-1/ADA4853-2/ADA4853-3 is required to provide good decoupling for lower frequency signals. The actual value is determined by the circuit transient and frequency requirements. In addition, $0.1\ \mu\text{F}$ MLCC decoupling capacitors should be located as close to each of the power supply pins as is physically possible, no more than $\frac{1}{8}$ inch away. The ground returns should terminate immediately into the ground plane. Locating the bypass capacitor return close to the load return minimizes ground loops and improves performance.

LAYOUT

As is the case with all high speed applications, careful attention to printed circuit board (PCB) layout details prevents associated board parasitics from becoming problematic. The ADA4853-1/ADA4853-2/ADA4853-3 can operate at up to 100 MHz; therefore, proper RF design techniques must be employed. The PCB should have a ground plane covering all unused portions of the component side of the board to provide a low impedance return path. Removing the ground plane on all layers from the area near and under the input and output pins reduces stray capacitance. Signal lines connecting the feedback and gain resistors should be kept as short as possible to minimize the inductance and stray capacitance associated with these traces. Termination resistors and loads should be located as close as possible to their respective inputs and outputs. Input and output traces should be kept as far apart as possible to minimize coupling (crosstalk) through the board. Adherence to microstrip or stripline design techniques for long signal traces (greater than 1 inch) is recommended. For more information on high speed board layout, go to www.analog.com to view *A Practical Guide to High-Speed Printed-Circuit-Board Layout*.

OUTLINE DIMENSIONS

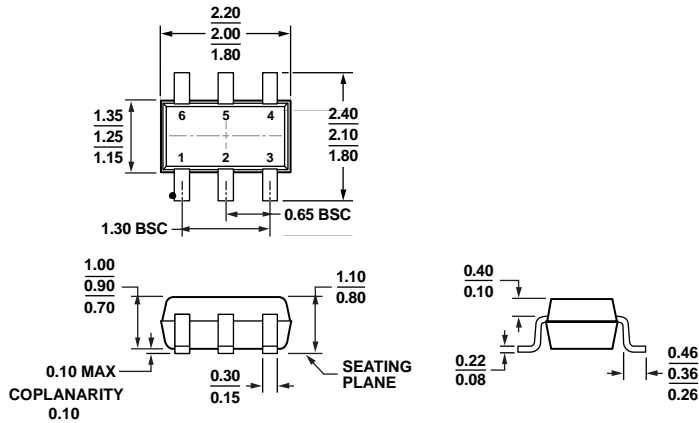

COMPLIANT TO JEDEC STANDARDS MO-203-AB

Figure 52. 6-Lead Thin Shrink Small Outline Transistor Package [SC70] (KS-6)

Dimensions shown in millimeters

072809-A

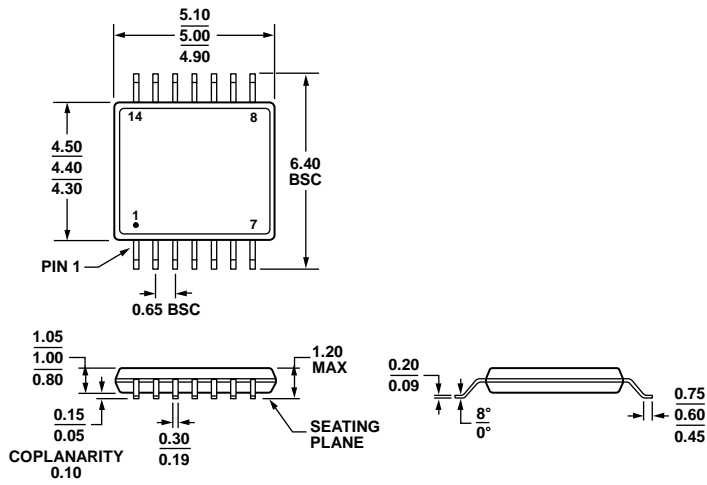

COMPLIANT TO JEDEC STANDARDS MO-153-AB-1

Figure 53. 14-Lead Thin Shrink Small Outline Package [TSSOP] (RU-14)

Dimensions shown in millimeters

061908-A

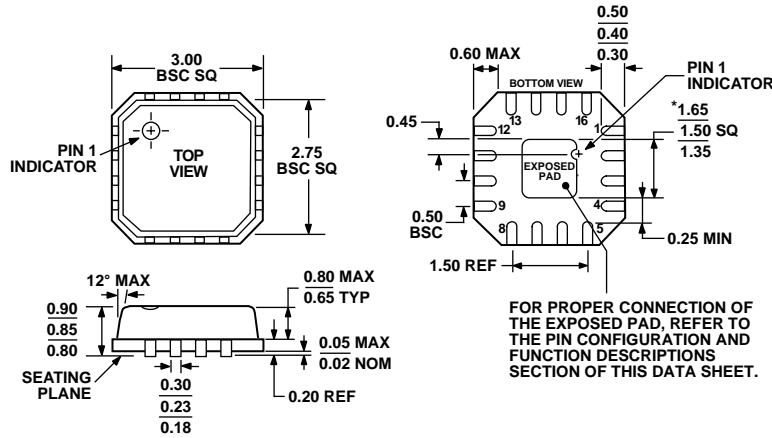

*COMPLIANT TO JEDEC STANDARDS MO-220-VEED-2 EXCEPT FOR EXPOSED PAD DIMENSION.

Figure 54. 16-Lead Lead Frame Chip Scale Package [LFCSP_VQ]
3 mm × 3 mm Body, Very Thin Quad (CP-16-3)
Dimensions shown in millimeters

07-172006-A

ORDERING GUIDE

Model ^{1,2}	Temperature Range	Package Description	Ordering Quantity	Package Option	Branding
ADA4853-1AKSZ-R2	-40°C to +85°C	6-Lead Thin Shrink Small Outline Transistor Package (SC70)	250	KS-6	HEC
ADA4853-1AKSZ-R7	-40°C to +85°C	6-Lead Thin Shrink Small Outline Transistor Package (SC70)	3000	KS-6	HEC
ADA4853-1AKSZ-RL	-40°C to +85°C	6-Lead Thin Shrink Small Outline Transistor Package (SC70)	10,000	KS-6	HEC
ADA4853-1AKS-EBZ		Evaluation Board	1		
ADA4853-2YCPZ-R2	-40°C to +105°C	16-Lead Lead Frame Chip Scale Package (LFCSP_VQ)	250	CP-16-3	H0H
ADA4853-2YCPZ-RL	-40°C to +105°C	16-Lead Lead Frame Chip Scale Package (LFCSP_VQ)	5000	CP-16-3	H0H
ADA4853-2YCPZ-RL7	-40°C to +105°C	16-Lead Lead Frame Chip Scale Package (LFCSP_VQ)	1500	CP-16-3	H0H
ADA4853-2YCP-EBZ		Evaluation Board	1		
ADA4853-3YCPZ-R2	-40°C to +105°C	16-Lead Lead Frame Chip Scale Package (LFCSP_VQ)	250	CP-16-3	H0L
ADA4853-3YCPZ-RL	-40°C to +105°C	16-Lead Lead Frame Chip Scale Package (LFCSP_VQ)	5000	CP-16-3	H0L
ADA4853-3YCPZ-R7	-40°C to +105°C	16-Lead Lead Frame Chip Scale Package (LFCSP_VQ)	1500	CP-16-3	H0L
ADA4853-3WYCPZ-R7	-40°C to +105°C	16-Lead Lead Frame Chip Scale Package (LFCSP_VQ)	1500	CP-16-3	H2H
ADA4853-3YCP-EBZ		Evaluation Board			
ADA4853-3YRUZ	-40°C to +105°C	14-Lead Thin Shrink Small Outline Package (TSSOP)	96	RU-14	
ADA4853-3YRUZ-RL	-40°C to +105°C	14-Lead Thin Shrink Small Outline Package (TSSOP)	2500	RU-14	
ADA4853-3YRUZ-R7	-40°C to +105°C	14-Lead Thin Shrink Small Outline Package (TSSOP)	1000	RU-14	
ADA4853-3YRU-EBZ		Evaluation Board	1		

¹ Z = RoHS Compliant Part.

² W = Qualified for Automotive Applications.

AUTOMOTIVE PRODUCTS

The ADA4853-3W model is available with controlled manufacturing to support the quality and reliability requirements of automotive applications. Note that these automotive models may have specifications that differ from the commercial models; therefore, designers should review the Specifications section of this data sheet carefully. Only the automotive grade products shown are available for use in automotive applications. Contact your local Analog Devices account representative for specific product ordering information and to obtain the specific Automotive Reliability reports for these models.

NOTES