

Small Signal Zener Diodes

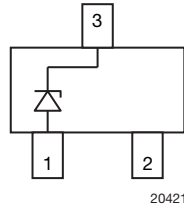

FEATURES

- Silicon planar power Zener diodes
- The zener voltages are graded according to the international E 24 standard. Standard zener voltage tolerance is $\pm 5\%$. Replace "C" with "B" for 2% tolerance.
- AEC-Q101 qualified
- Compliant to RoHS Directive 2002/95/EC and in accordance to WEEE 2002/96/EC



RoHS
COMPLIANT

GREEN
(5-2008)**

Note

** Please see document "Vishay Material Category Policy":
www.vishay.com/doc?99902

PRIMARY CHARACTERISTICS		
PARAMETER	VALUE	UNIT
V_Z range nom.	2.4 to 75	V
Test current I_{ZT}	2; 5	mA
V_Z specification	Pulse current	
Int. construction	Single	

ORDERING INFORMATION			
DEVICE NAME	ORDERING CODE	TAPED UNITS PER REEL	MINIMUM ORDER QUANTITY
BZX84-V-G-series	BZX84-V-series-G-18	10 000 (8 mm tape on 13" reel)	10 000
BZX84-V-G-series	BZX84-V-series-G-08	3000 (8 mm tape on 7" reel)	15 000

PACKAGE				
PACKAGE NAME	WEIGHT	MOLDING COMPOUND FLAMMABILITY RATING	MOISTURE SENSITIVITY LEVEL	SOLDERING CONDITIONS
SOT-23	8.1 mg	UL 94 V-0	MSL level 1 (according J-STD-020)	260 °C/10 s at terminals

ABSOLUTE MAXIMUM RATINGS					
PARAMETER	TEST CONDITION	SYMBOL	VALUE	UNIT	
Power dissipation	$T_{amb} = 25\text{ °C}$, device on fiberglass substrate, acc. layout on page 7	P_{tot}	300	mW	
Thermal resistance junction to ambient air	$T_{amb} = 25\text{ °C}$, device on fiberglass substrate, acc. layout on page 7	R_{thJA}	420	K/W	
Junction temperature		T_j	150	°C	
Storage temperature range		T_{stg}	- 65 to + 150	°C	



ELECTRICAL CHARACTERISTICS ($T_{amb} = 25\text{ }^{\circ}\text{C}$, unless otherwise specified)												
PART NUMBER	MARKING CODE	ZENER VOLTAGE RANGE			TEST CURRENT		REVERSE LEAKAGE CURRENT		DYNAMIC RESISTANCE		TEMPERATURE COEFFICIENT	
		V_Z at I_{ZT1}			I_{ZT1}	I_{ZT2}	I_R at V_R		Z_Z at I_{ZT1}	Z_{ZK} at I_{ZT2}	α_{VZ} at I_{ZT1}	
		V			mA		μA	V	Ω		$10^{-4}/^{\circ}\text{C}$	
		MIN.	NOM.	MAX.					MAX.	MAX.	MIN.	MAX.
BZX84C2V4-V-G	G50	2.2	2.4	2.6	5	1	50	1	100	275	-9	-4
BZX84C2V7-V-G	G51	2.5	2.7	2.9	5	1	20	1	100	600	-9	-4
BZX84C3V0-V-G	G52	2.8	3.0	3.2	5	1	10	1	95	600	-9	-3
BZX84C3V3-V-G	G53	3.1	3.3	3.5	5	1	5	1	95	600	-8	-3
BZX84C3V6-V-G	G54	3.4	3.6	3.8	5	1	5	1	90	600	-8	-3
BZX84C3V9-V-G	G55	3.7	3.9	4.1	5	1	3	1	90	600	-7	-3
BZX84C4V3-V-G	G56	4.0	4.3	4.6	5	1	3	1	90	600	-6	-1
BZX84C4V7-V-G	G57	4.4	4.7	5.0	5	1	3	2	80	500	-5	2
BZX84C5V1-V-G	G58	4.8	5.1	5.4	5	1	2	2	60	480	-3	4
BZX84C5V6-V-G	G59	5.2	5.6	6.0	5	1	1	2	40	400	-2	6
BZX84C6V2-V-G	G60	5.8	6.2	6.6	5	1	3	4	10	150	-1	7
BZX84C6V8-V-G	G61	6.4	6.8	7.2	5	1	2	4	15	80	2	7
BZX84C7V5-V-G	G62	7.0	7.5	7.9	5	1	1	5	15	80	3	7
BZX84C8V2-V-G	G63	7.7	8.2	8.7	5	1	0.7	5	15	80	4	7
BZX84C9V1-V-G	G64	8.5	9.1	9.6	5	1	0.5	6	15	100	5	8
BZX84C10-V-G	G65	9.4	10	10.6	5	1	0.2	7	20	150	5	8
BZX84C11-V-G	G66	10.4	11	11.6	5	1	0.1	8	20	150	5	9
BZX84C12-V-G	G67	11.4	12	12.7	5	1	0.1	8	25	150	6	9
BZX84C13-V-G	G68	12.4	13	14.1	5	1	0.1	8	30	170	7	9
BZX84C15-V-G	G69	13.8	15	15.6	5	1	0.05	10.5	30	200	7	9
BZX84C16-V-G	G70	15.3	16	17.1	5	1	0.05	11.2	40	200	8	9.5
BZX84C18-V-G	G71	16.8	18	19.1	5	1	0.05	12.6	45	225	8	9.5
BZX84C20-V-G	G72	18.8	20	21.2	5	1	0.05	14.0	55	225	8	10
BZX84C22-V-G	G73	20.8	22	23.3	5	1	0.05	15.4	55	250	8	10
BZX84C24-V-G	G74	22.8	24	25.6	5	1	0.05	16.8	70	250	8	10
BZX84C27-V-G	G75	25.1	27	28.9	2	0.5	0.05	18.9	80	300	8	10
BZX84C30-V-G	G76	28	30	32	2	0.5	0.05	21.0	80	300	8	10
BZX84C33-V-G	G77	31	33	35	2	0.5	0.05	23.1	80	325	8	10
BZX84C36-V-G	G78	34	36	38	2	0.5	0.05	25.2	90	350	8	10
BZX84C39-V-G	G79	37	39	41	2	0.5	0.05	27.3	130	350	10	12
BZX84C43-V-G	G80	40	43	46	2	0.5	0.05	30.1	150	375	10	12
BZX84C47-V-G	G81	44	47	50	2	0.5	0.05	32.9	170	375	10	12
BZX84C51-V-G	G82	48	51	54	2	0.5	0.05	35.7	180	400	10	12
BZX84C56-V-G	G83	52	56	60	2	0.5	0.05	39.2	200	425	9	11
BZX84C62-V-G	G84	58	62	66	2	0.5	0.05	43.4	215	450	9	12
BZX84C68-V-G	G85	64	68	72	2	0.5	0.05	47.6	240	475	10	12
BZX84C75-V-G	G86	70	75	79	2	0.5	0.05	52.5	255	500	10	12



ELECTRICAL CHARACTERISTICS ($T_{amb} = 25\text{ }^{\circ}\text{C}$, unless otherwise specified)													
PART NUMBER	MARKING CODE	ZENER VOLTAGE RANGE			TEST CURRENT		REVERSE LEAKAGE CURRENT		DYNAMIC RESISTANCE		TEMPERATURE COEFFICIENT		
		V_Z at I_{ZT1}			I_{ZT1}	I_{ZT2}	I_R at V_R		Z_Z at I_{ZT1}	Z_{ZK} at I_{ZT2}	α_{VZ} at I_{ZT1}		
		V			mA		μA	V	Ω		$10^{-4}/^{\circ}\text{C}$		
		MIN.	NOM.	MAX.					MAX.	MAX.	MIN.	MAX.	
BZX84B2V4-V-G	H50	2.35	2.4	2.45	5	1	50	1	100	275	-9	-4	
BZX84B2V7-V-G	H51	2.65	2.7	2.75	5	1	20	1	100	600	-9	-4	
BZX84B3V0-V-G	H52	2.94	3.0	3.06	5	1	10	1	95	600	-9	-3	
BZX84B3V3-V-G	H53	3.23	3.3	3.37	5	1	5	1	95	600	-8	-3	
BZX84B3V6-V-G	H54	3.53	3.6	3.67	5	1	5	1	90	600	-8	-3	
BZX84B3V9-V-G	H55	3.82	3.9	3.98	5	1	3	1	90	600	-7	-3	
BZX84B4V3-V-G	H56	4.21	4.3	4.39	5	1	3	1	90	600	-6	-1	
BZX84B4V7-V-G	H57	4.61	4.7	4.79	5	1	3	2	80	500	-5	2	
BZX84B5V1-V-G	H58	5.0	5.1	5.2	5	1	2	2	60	480	-3	4	
BZX84B5V6-V-G	H59	5.49	5.6	5.71	5	1	1	2	40	400	-2	6	
BZX84B6V2-V-G	H60	6.08	6.2	6.32	5	1	3	4	10	150	-1	7	
BZX84B6V8-V-G	H61	6.66	6.8	6.94	5	1	2	4	15	80	2	7	
BZX84B7V5-V-G	H62	7.35	7.5	7.65	5	1	1	5	15	80	3	7	
BZX84B8V2-V-G	H63	8.04	8.2	8.36	5	1	0.7	5	15	80	4	7	
BZX84B9V1-V-G	H64	8.92	9.1	9.28	5	1	0.5	6	15	100	5	8	
BZX84B10-V-G	H65	9.8	10	10.2	5	1	0.2	7	20	150	5	8	
BZX84B11-V-G	H66	10.8	11	11.2	5	1	0.1	8	20	150	5	9	
BZX84B12-V-G	H67	11.8	12	12.2	5	1	0.1	8	25	150	6	9	
BZX84B13-V-G	H68	12.7	13	13.3	5	1	0.1	8	30	170	7	9	
BZX84B15-V-G	H69	14.7	15	15.3	5	1	0.05	10.5	30	200	7	9	
BZX84B16-V-G	H70	15.7	16	16.3	5	1	0.05	11.2	40	200	8	9.5	
BZX84B18-V-G	H71	17.6	18	18.4	5	1	0.05	12.6	45	225	8	9.5	
BZX84B20-V-G	H72	19.6	20	20.4	5	1	0.05	14	55	225	8	10	
BZX84B22-V-G	H73	21.6	22	22.4	5	1	0.05	15.4	55	250	8	10	
BZX84B24-V-G	H74	23.5	24	24.5	5	1	0.05	16.8	70	250	8	10	
BZX84B27-V-G	H75	26.5	27	27.5	2	0.5	0.05	18.9	80	300	8	10	
BZX84B30-V-G	H76	29.4	30	30.6	2	0.5	0.05	21	80	300	8	10	
BZX84B33-V-G	H77	32.3	33	33.7	2	0.5	0.05	23.1	80	325	8	10	
BZX84B36-V-G	H78	35.3	36	36.7	2	0.5	0.05	25.2	90	350	8	10	
BZX84B39-V-G	H79	38.2	39	39.8	2	0.5	0.05	27.3	130	350	10	12	
BZX84B43-V-G	H80	42.1	43	43.9	2	0.5	0.05	30.1	150	375	10	12	
BZX84B47-V-G	H81	46.1	47	47.9	2	0.5	0.05	32.9	170	375	10	12	
BZX84B51-V-G	H82	50	51	52	2	0.5	0.05	35.7	180	400	10	12	
BZX84B56-V-G	H83	54.9	56	57.1	2	0.5	0.05	39.2	200	425	9	11	
BZX84B62-V-G	H84	60.8	62	63.2	2	0.5	0.05	43.4	215	450	9	12	
BZX84B68-V-G	H85	66.6	68	69.4	2	0.5	0.05	47.6	240	475	10	12	
BZX84B75-V-G	H86	73.5	75	76.5	2	0.5	0.05	52.5	255	500	10	12	



BASIC CHARACTERISTICS ($T_{amb} = 25\text{ }^{\circ}\text{C}$, unless otherwise specified)

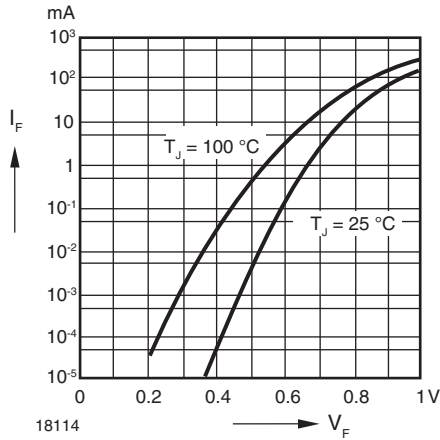

Fig. 1 - Forward Characteristics

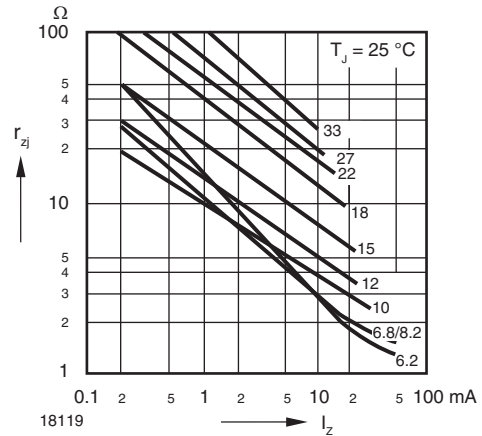

Fig. 4 - Dynamic Resistance vs. Zener Current

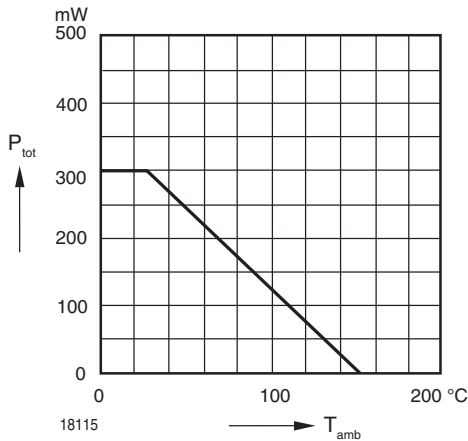

Fig. 2 - Admissible Power Dissipation vs. Ambient Temperature

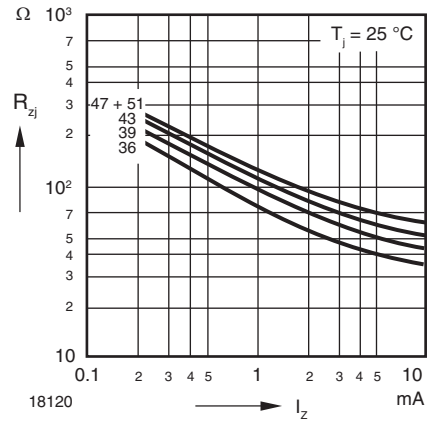

Fig. 5 - Dynamic Resistance vs. Zener Current

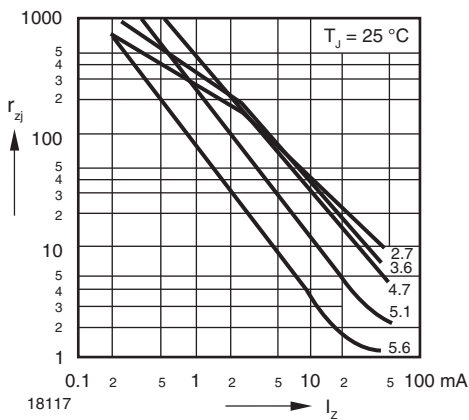

Fig. 3 - Dynamic Resistance vs. Zener Current

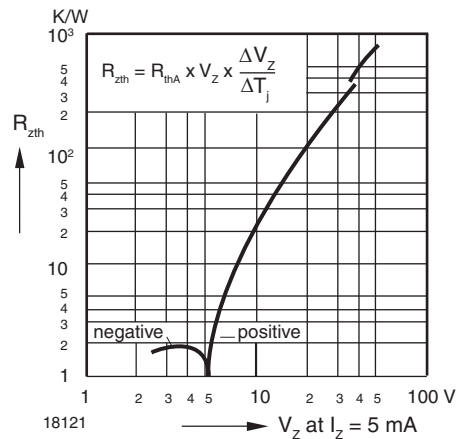

Fig. 6 - Thermal Differential Resistance vs. Zener Voltage

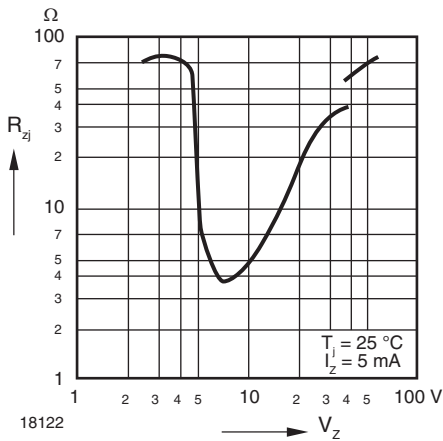

Fig. 7 - Dynamic Resistance vs. Zener Voltage

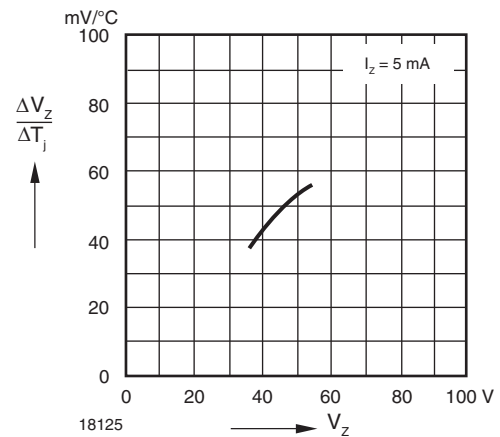

Fig. 10 - Temperature Dependence of Zener Voltage vs. Zener Voltage

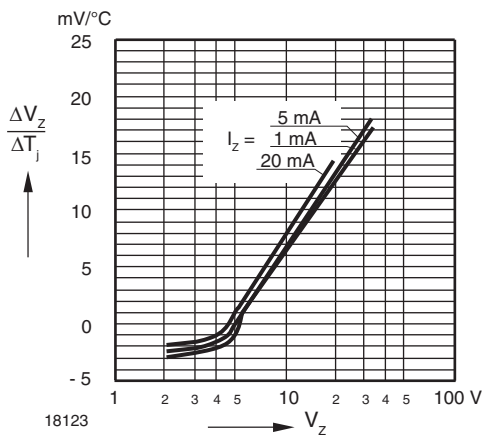

Fig. 8 - Temperature Dependence of Zener Voltage vs. Zener Voltage

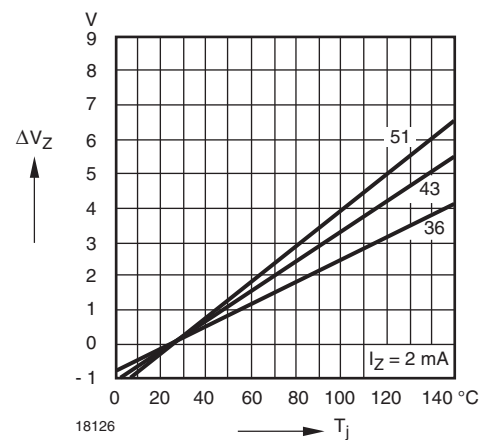

Fig. 11 - Change of Zener Voltage vs. Junction Temperature

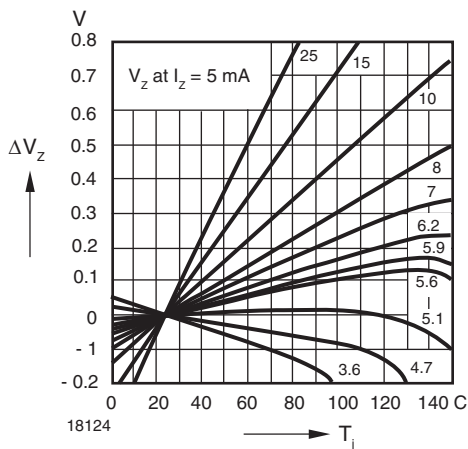

Fig. 9 - Change of Zener Voltage vs. Junction Temperature

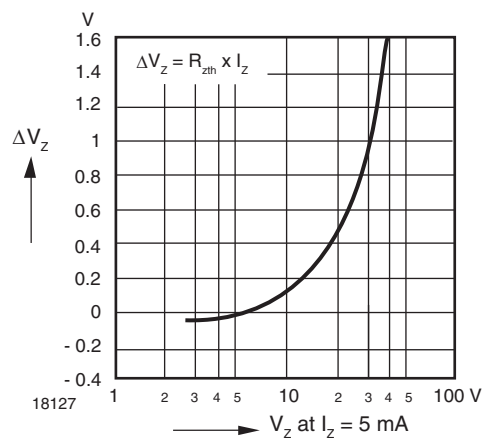

Fig. 12 - Change of Zener Voltage from Turn-on up to the Point of Thermal Equilibrium vs. Zener Voltage

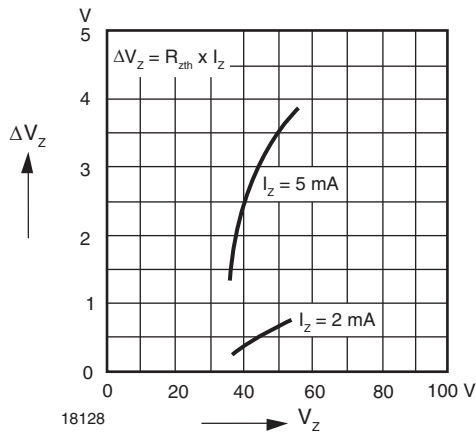

Fig. 13 - Change of Zener Voltage from Turn-on up to the Point of Thermal Equilibrium vs. Zener Voltage

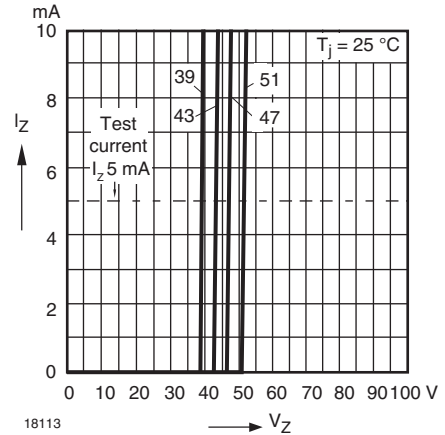

Fig. 16 - Breakdown Characteristics

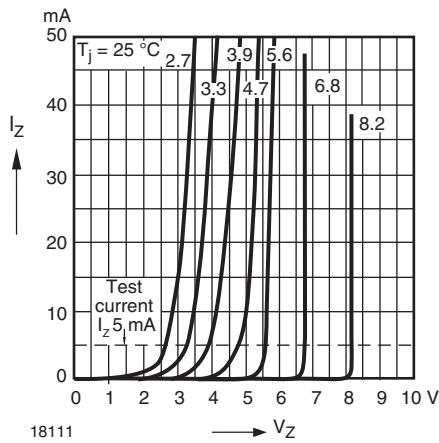

Fig. 14 - Breakdown Characteristics

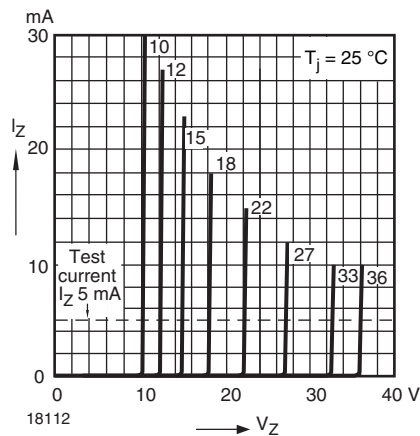
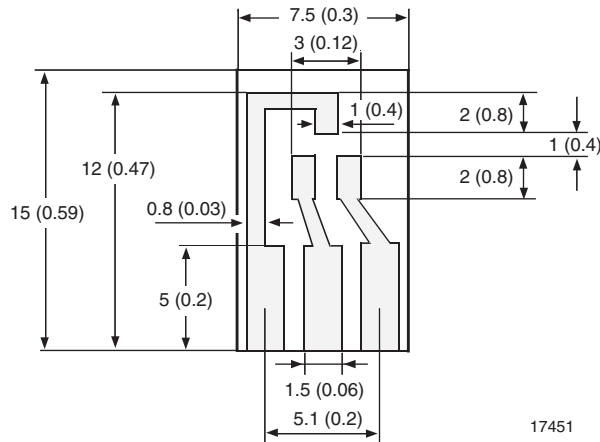

Fig. 15 - Breakdown Characteristics

LAYOUT FOR R_θ; J_A TEST

Thickness: fiberglass 0.059" (1.5 mm)
Copper leads 0.012" (0.3 mm)



PACKAGE DIMENSIONS in millimeters (inches): SOT-23

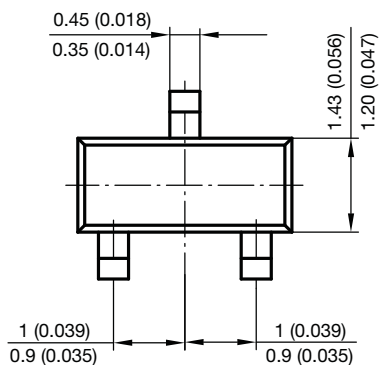
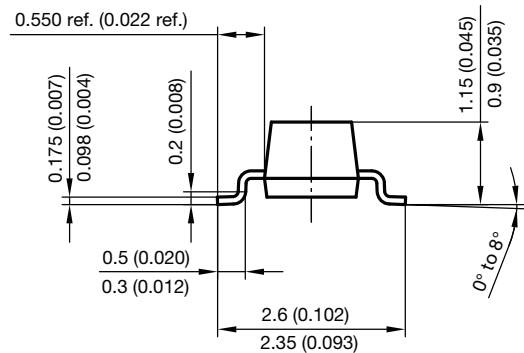
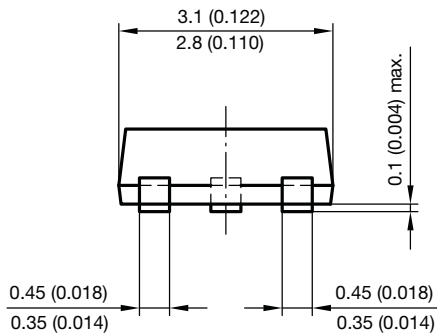

Foot print recommendation:

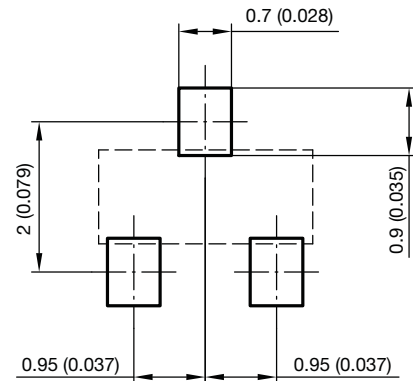

Document no.: 6.541-5014.01-4

Rev. 8 - Date: 23.Sept.2009

17418



Disclaimer

ALL PRODUCT, PRODUCT SPECIFICATIONS AND DATA ARE SUBJECT TO CHANGE WITHOUT NOTICE TO IMPROVE RELIABILITY, FUNCTION OR DESIGN OR OTHERWISE.

Vishay Intertechnology, Inc., its affiliates, agents, and employees, and all persons acting on its or their behalf (collectively, "Vishay"), disclaim any and all liability for any errors, inaccuracies or incompleteness contained in any datasheet or in any other disclosure relating to any product.

Vishay makes no warranty, representation or guarantee regarding the suitability of the products for any particular purpose or the continuing production of any product. To the maximum extent permitted by applicable law, Vishay disclaims (i) any and all liability arising out of the application or use of any product, (ii) any and all liability, including without limitation special, consequential or incidental damages, and (iii) any and all implied warranties, including warranties of fitness for particular purpose, non-infringement and merchantability.

Statements regarding the suitability of products for certain types of applications are based on Vishay's knowledge of typical requirements that are often placed on Vishay products in generic applications. Such statements are not binding statements about the suitability of products for a particular application. It is the customer's responsibility to validate that a particular product with the properties described in the product specification is suitable for use in a particular application. Parameters provided in datasheets and/or specifications may vary in different applications and performance may vary over time. All operating parameters, including typical parameters, must be validated for each customer application by the customer's technical experts. Product specifications do not expand or otherwise modify Vishay's terms and conditions of purchase, including but not limited to the warranty expressed therein.

Except as expressly indicated in writing, Vishay products are not designed for use in medical, life-saving, or life-sustaining applications or for any other application in which the failure of the Vishay product could result in personal injury or death. Customers using or selling Vishay products not expressly indicated for use in such applications do so at their own risk and agree to fully indemnify and hold Vishay and its distributors harmless from and against any and all claims, liabilities, expenses and damages arising or resulting in connection with such use or sale, including attorneys fees, even if such claim alleges that Vishay or its distributor was negligent regarding the design or manufacture of the part. Please contact authorized Vishay personnel to obtain written terms and conditions regarding products designed for such applications.

No license, express or implied, by estoppel or otherwise, to any intellectual property rights is granted by this document or by any conduct of Vishay. Product names and markings noted herein may be trademarks of their respective owners.

Material Category Policy

Vishay Intertechnology, Inc. hereby certifies that all its products that are identified as RoHS-Compliant fulfill the definitions and restrictions defined under Directive 2011/65/EU of The European Parliament and of the Council of June 8, 2011 on the restriction of the use of certain hazardous substances in electrical and electronic equipment (EEE) - recast, unless otherwise specified as non-compliant.

Please note that some Vishay documentation may still make reference to RoHS Directive 2002/95/EC. We confirm that all the products identified as being compliant to Directive 2002/95/EC conform to Directive 2011/65/EU.