

MS27476 Box Mount Hermetic Receptacle MIL-DTL-38999 Series II

How To Order: MS

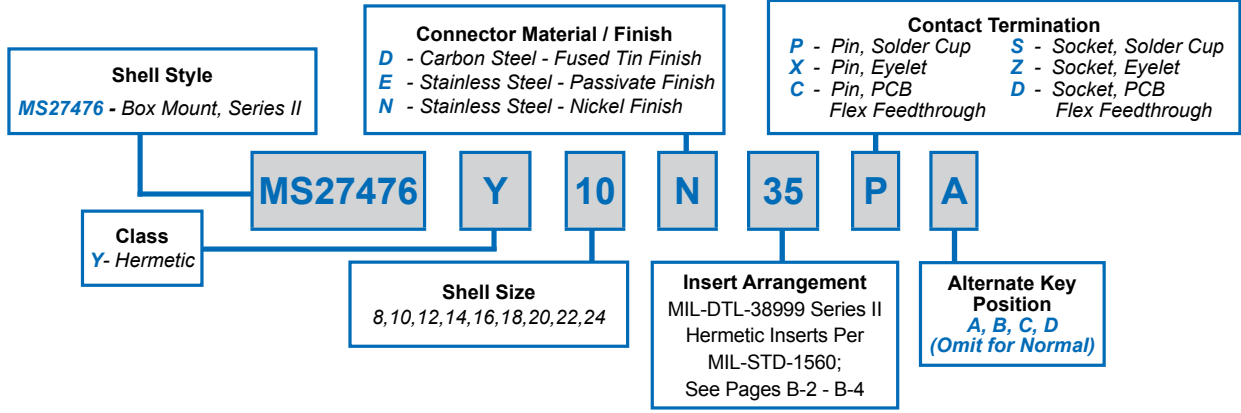

B

Datasheet Live

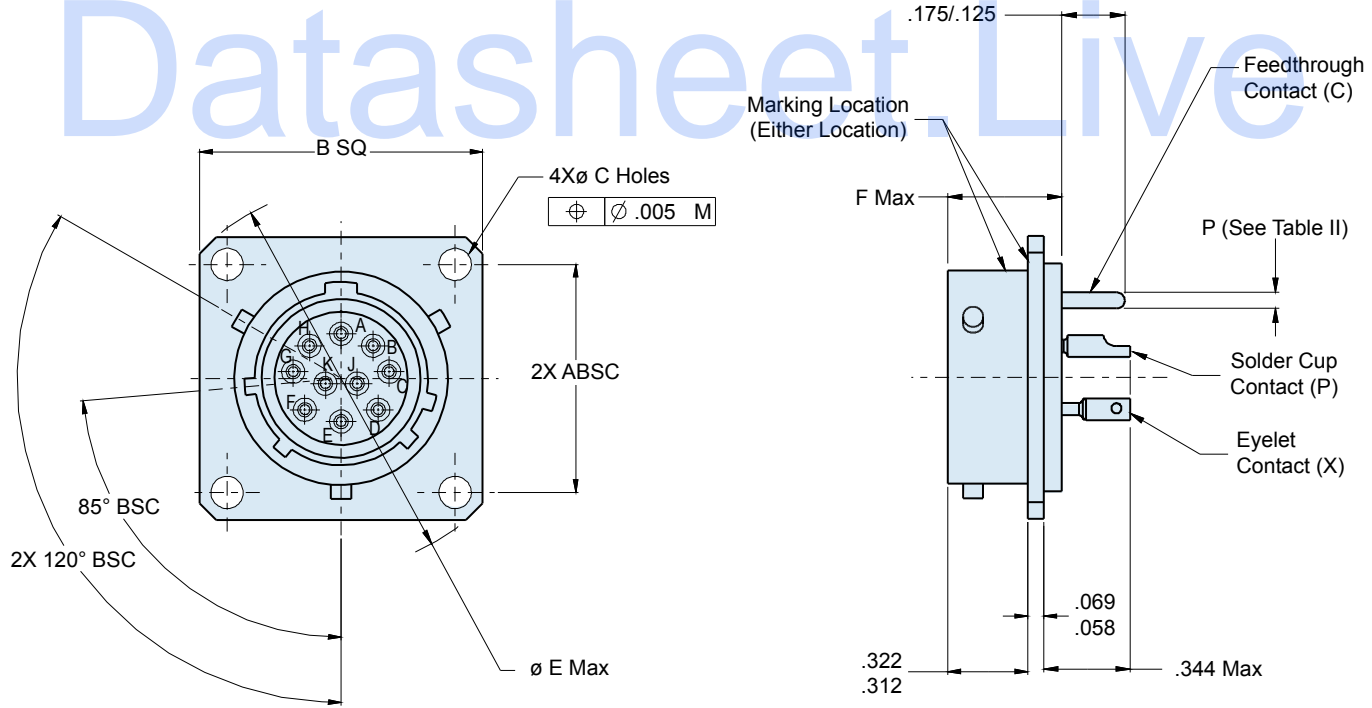

MS27476 Box Mount Hermetic Receptacle MIL-DTL-38999 Series II



D38999 QPL
Hermetics

How To Order: Commercial

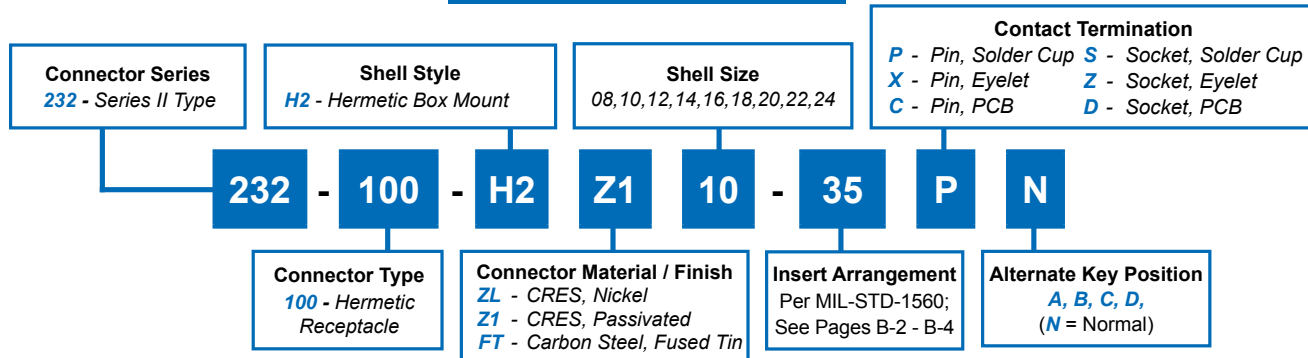

B

SHELL SIZE	A BSC	B SQ MAX	Ø C HOLES	Ø E MAX	F MAX
8/08	.594(15.1)	.828(21.0)	.130(3.3) .115(2.9)	1.078(27.4)	.453(11.5)
10	.719(18.3)	.954(24.2)		1.266(32.2)	
12	.812(20.6)	1.047(26.6)		1.391(35.3)	
14	.906(23.0)	1.141(29.0)		1.516(38.5)	
16	.969(24.6)	1.234(31.3)		1.641(41.7)	
18	1.062(27.0)	1.328(33.7)		1.766(44.9)	
20	1.156(29.4)	1.453(36.9)		1.891(48.0)	
22	1.250(31.8)	1.578(40.1)		2.016(51.2)	
24	1.375(34.9)	1.703(43.3)	.157(4.0) .142(3.6)	2.204(56.0)	.484(12.3)

Contact Size	Ø P
22D	.011 (0.28) .015 (0.38)
20	.024 (0.61) .028 (0.71)
16	.0635 (1.61) .0615 (1.56)
12	.095 (2.41) .093 (2.36)

PRINTED CIRCUIT TAIL CONFIGURATIONS
CONTACT STYLE C AND D

SHELL SIZE	Ø G HOLES	Ø H MIN	Ø J BSC
8/08	.133(3.4) .123(3.1)	.570(14.5)	.594(15.1)
10		.690(17.5)	.719(18.3)
12		.820(20.8)	.812(20.6)
14		.940(23.9)	.906(23.0)
16		1.070(27.2)	.969(24.6)
18		1.190(30.2)	1.062(27.0)
20		1.320(33.5)	1.156(29.4)
22		.159(4.0) .149(3.8)	1.440(36.6)
24		1.570(39.9)	1.375(34.9)

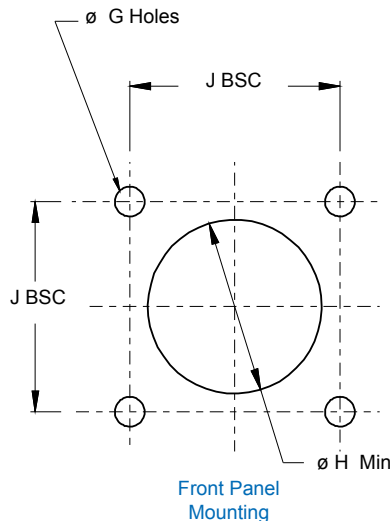

The Full Range of MIL-DTL-38999 Series I, II, III and IV Hermetic Receptacles—Plus Glenair Commercial Equivalents

Product Applications

The MIL-DTL-38999 Series I, II, III and IV family of hermetic connectors are ideal for high-pressure/low-leakage applications in air, sea and space environments. Glenair is on the Qualified Product List (QPL) for all configurations of MIL-DTL-38999 Series I through IV pin and socket hermetic connectors. We also offer our D38999 type commercial part numbers for applications that do not require MS qualified products.

Materials

Glenair MIL-DTL-38999 Series I, II, III and IV Hermetic Connectors are made of stainless (CRES) or cold rolled steel (CRS), with glass

Nickel-iron alloy 52 gold-plated contacts, available in sizes 8, 10, 12, 16, 20 and 22D, depending on the layout chosen, offer a wide selection of insert arrangement options. Solder cup, feed through (PCB Flexprint) and eyelet contact styles are also available.

Same-Day Inventory

Because Glenair makes all its hermetic connectors in-house, including the machining of shells, molding of interfacial seals and firing of hermetic components, we can offer you outstanding availability on stock products and fast turnaround on special orders.

Same-Day Delivery on Most Common Shell Styles and Layouts

Full Range of D38999 Series I thru IV Pin and Socket Insert Arrangements

DSCC Approved QPL Hermetics

1 x 10⁻⁷ cc/Helium per Second Leakage Rate

CRES, CRS, Titanium and Inconel® Shells with Vitreous Glass Sealing

Jam Nut, Solder Mount, Wall Mount and Box Mount Options



insulators fused to the connector shell, and contacts meeting a leak rate of 1 X 10⁻⁷ cc/Helium per second. Maximum design flexibility is built into the Series I, II, III and IV Military Standard Hermetic Connectors—with a minimum of 2 to a maximum of 128 circuits per connector in a wide variety of contact arrangements IAW MIL-STD-1560. Fluorosilicone rubber interfacial and peripheral seals ensure positive sealing with plug connectors.

Catalog contents—including part numbers, materials and dimensions—are accurate to the best of our ability when we go to print. Even so, customers are advised to consult the factory for the latest specifications, particularly to confirm critical dimensions such as connector lengths, threads, and so on. When errors or mistakes are brought to our attention, corrected content is posted immediately on our website, www.glenair.com.

B

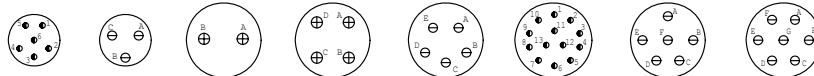

Series I	9-35	9-98	11-2	11-4	11-5	11-35	11-98	11-99
Series II	8-35	8-98	10-2	10-4	10-5	10-35	10-98	10-99
Series III	A35	A98	B2	B4	B5	B35	B98	B99
Series IV	---	---	---	---	B5	B35	B98	B99

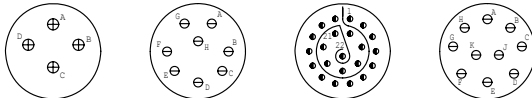

Series I	13-4	13-8	13-35	13-98
Series II	12-4	12-8	12-35	12-98
Series III	C4	C8	C35	C98
Series IV	C4	---	C35	C98

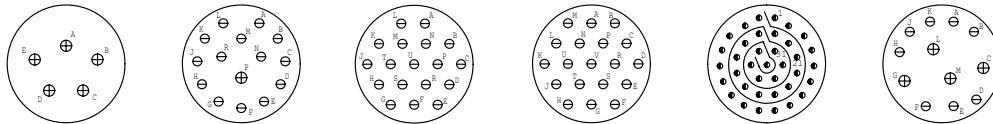

Series I	15-5	15-15	15-18	15-19	15-35	15-97
Series II	14-5	14-15	14-18	14-19	14-35	14-97
Series III	D5	D15	D18	D19	D35	D97
Series IV	D5	---	D18	D19	D35	D97

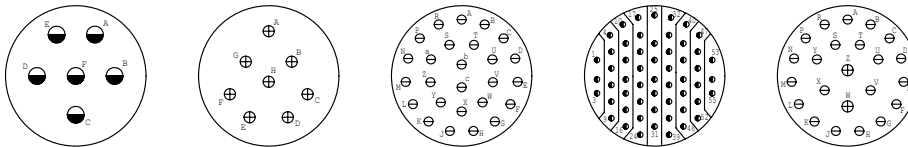

Series I	17-6	17-8	17-26	17-35	17-99
Series II	16-6	16-8	16-26	16-35	16-99
Series III	E6	E8	E26	E35	E99
Series IV	E6	E8	E26	E35	---

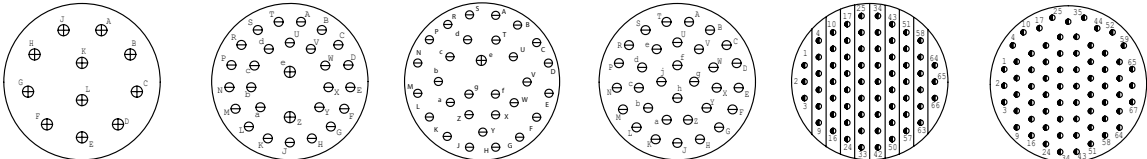

Series I	19-11	19-28	19-30	19-32	19-35	19-45
Series II	18-11	18-28	18-30	18-32	18-35	18-45
Series III	F11	F28	F30	F32	F35	F45
Series IV	F11	---	---	F32	F35	---

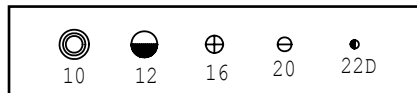

MIL-DTL-38999 Series I, II, III, and IV Hermetic Class Connectors Insert Arrangements (IAW MIL-STD-1560)



MIL-DTL
38999

B

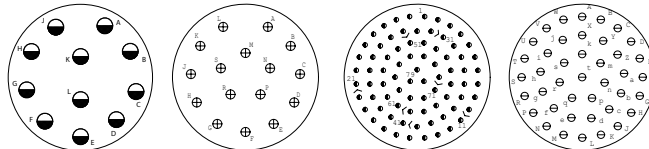

Series I	21-11	21-16	21-35	21-41
Series II	20-11	20-16	20-35	20-41
Series III, IV	G11, G11	G16, G16	G35, G35	G41, G41

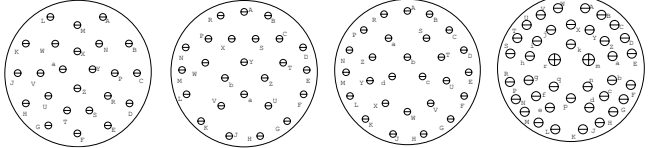

Series I	21-24	21-25	21-27	21-39
Series II	20-24	20-25	20-27	20-39
Series III, IV	G24, G24	G25, ---	G27, ---	G39, ---

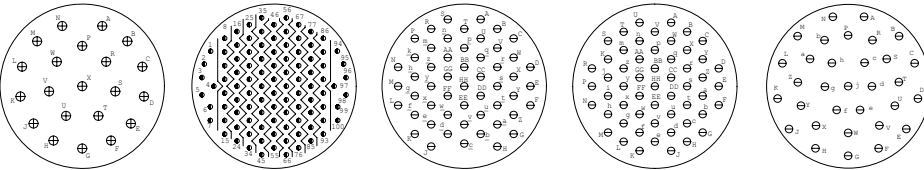

Series I	23-21	23-35	23-53	23-55	23-32
Series II	22-21	22-35	22-53	22-55	22-32
Series III, IV	H21, H21	H35, H35	H53, ---	H55, H55	H32, ---

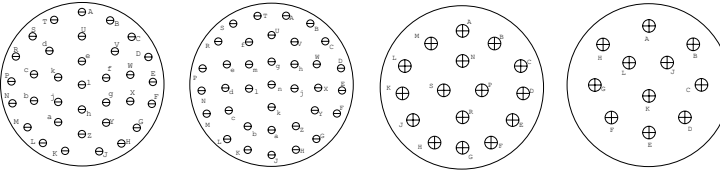

Series I	23-34	23-36	23-97	23-99
Series II	22-34	22-36	22-97	22-99
Series III, IV	H34, ---	H36, ---	H97, ---	H99, ---

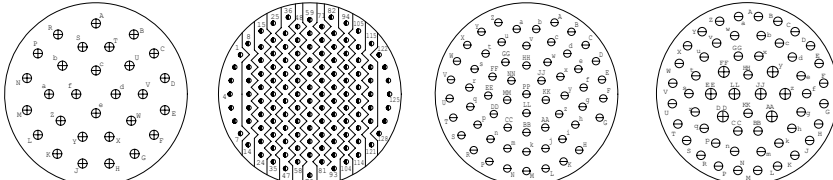

Series I	25-29	25-35	25-61	25-4
Series II	24-29	24-35	24-61	24-4
Series III, IV	J29, J29	J35, J35	J61, J61	J4, J4

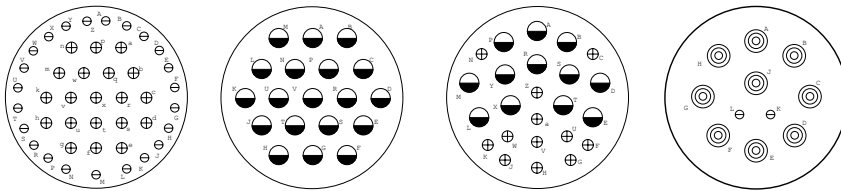

Series I	25-43	25-19	25-24	J-11
Series II	24-43	24-19	24-24	(Series IV Only)
Series III, IV	J43, J43	J19, J19	J24, J24	

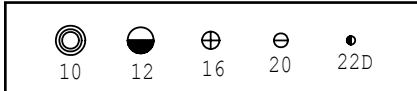



MIL-DTL-38999 Series I, II, III, and IV
Hermetic Class Connectors
Layouts and Pin Counts

B

Shell Size and Insert Arrangements				Number of Pins			
MS Series I	MS Series II	D38999 Series III	Service Rating	22D	20	16	12
9-35	8-35	A35	M	6			
9-98	8-98	A98	I		3		
11-2	10-2	B2	I			2	
11-4	10-4	B4	I		4		
11-5	10-5	B5	I		5		
11-35	10-35	B35	M	13			
11-98	10-98	B98	I		6		
11-99	10-99	B99	I		7		
13-4	12-4	C4	I			4	
13-8	12-8	C8	I		8		
13-35	12-35	C35	M	22			
13-98	12-98	C98	I		10		
15-5	14-5	D5	II			5	
15-15	14-15	D15	I		14	1	
15-18	14-18	D18	I		18		
15-19	14-19	D19	I		19		
15-35	14-35	D35	M	37			
15-97	14-97	D97	I		8	4	
17-6	16-6	E6	I				6
17-8	16-8	E8	II			8	
17-26	16-26	E26	I		26		
17-35	16-35	E35	M	55			
17-99	16-99	E99	I		21	2	
19-11	18-11	F11	II			11	
19-28	18-28	F28	I		26	2	
19-30	18-30	F30	I		29	1	
19-32	18-32	F32	I		32		
19-35	18-35	F35	M	66			
19-45	18-45	F45	M	67			
21-11	20-11	G11	I				11
21-16	20-16	G16	II			16	
21-24	20-24	G24	I		24		
21-25	20-25	G25	I		25		
21-27	20-27	G27	I		27		
21-35	20-35	G35	M	79			
21-39	20-39	G39	I		37	2	
21-41	20-41	G41	I		41		
23-21	22-21	H21	II			21	
23-32	22-32	H32	I		32		
23-34	22-34	H34	I		34		
23-35	22-35	H35	M	100			
23-36	22-36	H36	I		36		
23-53	22-53	H53	I		53		
23-55	22-55	H55	I		55		
23-97	22-97	H97	I			16	
23-99	22-99	H99	II			11	
25-4	24-4	J4	I		48	8	
25-19	24-19	J19	I				19
25-24	24-24	J24	I			12	12
25-29	24-29	J29	I			29	
25-35	24-35	J35	M	128			
25-37	N/A	J37				37	
25-43	24-43	J43	I		23	20	
25-61	24-61	J61	I		61		

Shell Size / Insert Arrangements		Number of Pins			
D38999 Series IV	22D	20	16	12	10
B5		5			
B35	13				
B98		6			
B99		7			
C4			4		
C35	22				
C98		10			
D5			5		
D18		18			
D19	37	19			
D35					
D97		8	4		
E6				6	
E8			8		
E26		26			
E35	55				
F11			11		
F32		32			
F35	66				
G11				11	
G16			16		
G35	79				
G41		41			
H21			21		
H35	100				
H55		55			
J4		48	8		
J11		2			9
J19				19	
J24			12	12	
J29			29		
J35	128				
J37			37		
J43		23	20		
J61		61			