

## FEATURES

- PRECISE TOLERANCE AND TEMPERATURE COEFFICIENT
- EIA STANDARD CASE SIZES (0201 ~ 2512)
- LOW NOISE, THIN FILM (NiCr) CONSTRUCTION
- REFLOW SOLDERABLE (Pb FREE TERMINATION FINISH)

**RoHS**  
**Compliant**  
includes all homogeneous materials

\*See Part Number System for Details

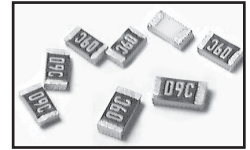

Type	EIA Size	Power Rating at 70°C	Max.*1 Working Voltage	Max.*2 Overload Voltage	Resistance Tolerance (Code)	Temperature Coefficient (ppm/°C)	Resistance Range (Ω)	Resistance Values
NTR02	0201	1/32 (0.032)W	15V	30V	±0.5% (D), ±1.0% (F)	±25 (C)	49.9 ~ 4.99KΩ	E-24, E-96 & E-192
					±0.5% (D), ±1.0% (F)	±50 (D)	49.9 ~ 33KΩ	
NTR04	0402	1/16 (0.063)W	25V	50V	±0.01% (T), ±0.05% (A), ±0.1% (B), ±0.25 (C), ±0.5% (D), ±1% (F)	±2 (X), ±3 (O)	49.9 ~ 4.99KΩ	
					±0.01% (T), ±0.05% (A)	±5 (S)	49.9 ~ 4.99KΩ	
					±0.01% (T), ±0.05% (A)	±10 (B)	49.9 ~ 12KΩ	
					±0.1% (B), ±0.25 (C), ±0.5% (D), ±1% (F)	±10 (B)	49.9 ~ 60.4KΩ	
					±0.01% (T), ±0.05% (A)	±15 (N)	49.9 ~ 12KΩ	
					±0.1% (B), 0.25 (C), ±0.5% (D), ±1% (F)	±15 (N)	49.9 ~ 69.8KΩ	
					±0.05% (A)	±25(C), ±50(D)	49.9 ~ 12KΩ	
					±0.1% (B)	±25 (C)	10 ~ 511KΩ	
					±0.25% (C), ±0.5% (D), ±1% (F)	±25 (C)	4.7 ~ 511KΩ	
					±0.1% (B)	±50 (D)	10 ~ 511KΩ	
NTR06	0603	1/16 (0.063)W	50V	100V	±0.5% (D), ±1% (F)	±50 (D)	4.7 ~ 511KΩ	
					±0.01% (T), ±0.05% (A), ±0.1% (B), ±0.25 (C), ±0.5% (D), ±1% (F)	±2 (X), ±3 (O)	24.9 ~ 15KΩ	
					±0.01% (T), ±0.05% (A), ±0.1% (B), ±0.25 (C), ±0.5% (D), ±1% (F)	±5 (S)	24.9 ~ 15KΩ	
					±0.01% (T)	±10(B), ±15(N)	24.9 ~ 100KΩ	
					±0.05% (A)	±10(B), ±15(N)	4.7 ~ 332KΩ	
					±0.1% (B), ±0.25 (C), ±0.5% (D), ±1% (F)	±10(B), ±15(N)	4.7 ~ 511KΩ	
NTR10	0805	1/10 (0.10) W	100V	200V	±0.05% (A)	±25(C), ±50(D)	4.7 ~ 332KΩ	
					±0.1% (B)	±25(C), ±50(D)	4.7 ~ 1MΩ	
					±0.25 (C), ±0.5 (D), ±1% (F)	±25(C), ±50(D)	1.0 ~ 1MΩ	
					±0.01% (T), ±0.05% (A), ±0.1% (B), ±0.25 (C), ±0.5% (D), ±1% (F)	±2 (X), ±3 (O)	24.9 ~ 30KΩ	
					±0.01% (T)	±10(B), ±15(N)	24.9 ~ 200KΩ	
					±0.05% (A), ±0.1% (B), ±0.25 (C), ±0.5% (D), ±1% (F)	±10(B), ±15(N)	4.7 ~ 1MΩ	
NTR12	1206	1/8 (0.125) W	150V	300V	±0.05 (A)	±25(C), ±50(D)	4.7 ~ 1MΩ	
					±0.1% (B)	±25(C), ±50(D)	4.7 ~ 2MΩ	
					±0.25 (C), ±0.5 (D), ±1% (F)	±25(C), ±50(D)	1.0 ~ 2MΩ	
					±0.01% (T), ±0.05% (A), ±0.1% (B), ±0.25 (C), ±0.5% (D), ±1% (F)	±2 (X), ±3 (O)	24.9 ~ 49.9KΩ	
					±0.01% (T), ±0.05% (A), ±0.1% (B), ±0.25 (C), ±0.5% (D), ±1% (F)	±5 (S)	24.9 ~ 49.9KΩ	
					±0.01% (T)	±10(B), ±15(N)	24.9 ~ 499KΩ	

For 2010 and 2512 case sizes see page 2



Type	EIA Size	Power Rating at 70°C	Max.*1 Working Voltage	Max.*2 Overload Voltage	Resistance Tolerance (Code)	Temperature Coefficient (ppm/°C)	Resistance Range (Ω)	Resistance Values
NTR20	1210	1/4 (0.25) W	150V	300V	±0.01% (T), ±0.05% (A), ±0.1% (B), ±0.01% (T), ±0.05% (A), ±0.1% (B), ±0.25 (C), ±0.5% (D), ±1% (F)	±2 (X), ±3 (O)	24.9 ~ 49.9KΩ	E-24, E-96 & E-192
					±0.01% (T)	±5 (S)	24.9 ~ 49.9KΩ	
					±0.01% (T)	±10(B), ±15(N)	24.9 ~ 499KΩ	
					±0.05% (A), ±0.1% (B), ±0.25 (C), ±0.5% (D), ±1% (F)	±10(B), ±15(N)	4.7 ~ 1MΩ	
					±0.05% (A)	±25(C), ±50(D)	4.7 ~ 1MΩ	
					±0.1% (B)	±25(C), ±50(D)	4.7 ~ 2.49MΩ	
					±0.25% (C), ±0.5% (D), ±1% (F)	±25(C), ±50(D)	1.0 ~ 2.49MΩ	
NTR25	2010	1/4 (0.25) W	150V	300V	±0.01% (T), ±0.05% (A), ±0.1% (B), ±0.01% (T), ±0.05% (A), ±0.1% (B), ±0.25 (C), ±0.5% (D), ±1% (F)	±2 (X), ±3 (O)	24.9 ~ 100KΩ	
					±0.01% (T)	±5 (S)	24.9 ~ 100KΩ	
					±0.01% (T)	±10(B), ±15(N)	24.9 ~ 499KΩ	
					±0.05% (A), ±0.1% (B), ±0.25 (C), ±0.5% (D), ±1% (F)	±10(B), ±15(N)	4.7 ~ 1MΩ	
					±0.05% (A)	±25(C), ±50(D)	4.7 ~ 1MΩ	
					±0.1% (B)	±25(C), ±50(D)	4.7 ~ 3MΩ	
					±0.25% (C), ±0.5% (D), ±1% (F)	±25(C), ±50(D)	1.0 ~ 3MΩ	
NTR50	2512	1/2 (0.50) W	150V	300V	±0.01% (T), ±0.05% (A), ±0.1% (B), ±0.01% (T), ±0.05% (A), ±0.1% (B), ±0.25 (C), ±0.5% (D), ±1% (F)	±2 (X), ±3 (O)	24.9 ~ 100KΩ	
					±0.01% (T)	±5 (S)	24.9 ~ 100KΩ	
					±0.01% (T)	±10(B), ±15(N)	24.9 ~ 499KΩ	
					±0.05% (A), ±0.1% (B), ±0.25 (C), ±0.5% (D), ±1% (F)	±10(B), ±15(N)	4.7 ~ 1MΩ	
					±0.05% (A)	±25(C), ±50(D)	4.7 ~ 1MΩ	
					±0.1% (B)	±25(C), ±50(D)	4.7 ~ 3MΩ	
					±0.25% (C), ±0.5% (D), ±1% (F)	±25(C), ±50(D)	1.0 ~ 3MΩ	

Note \*1 - Maximum allowable continuous Working Voltage for all resistors is the lower of the two values:  
"Maximum Working Voltage" as specified above  
or

$$\sqrt{\text{Power rating (Watts) x Resistance (Ohms)}}$$

Note \*2 - Maximum Overload Voltage for all resistors is the lower of the two values:  
"Maximum Overload Voltage" as specified above  
or

$$2 \times \sqrt{\text{Power rating (Watts) x Resistance (Ohms)}}$$

### TYPICAL NOISE CHARACTERISTICS

Resistance Value (Ω)	Case Size		
	0603	0805	1206
1 ~ 9	-95dB	-95dB	-95dB
10 ~ 49	-85dB	-85dB	-85dB
50 ~ 99	-85dB	-85dB	-85dB
100 ~ 4.99K	-100dB	-100dB	-105dB
5K ~ 19.9K	-100dB	-100dB	-100dB
20K ~ 1M	-90dB	-100dB	-100dB

**Power Derating Curve:** For operation above 70°C, power rating must be derated according to the following chart:

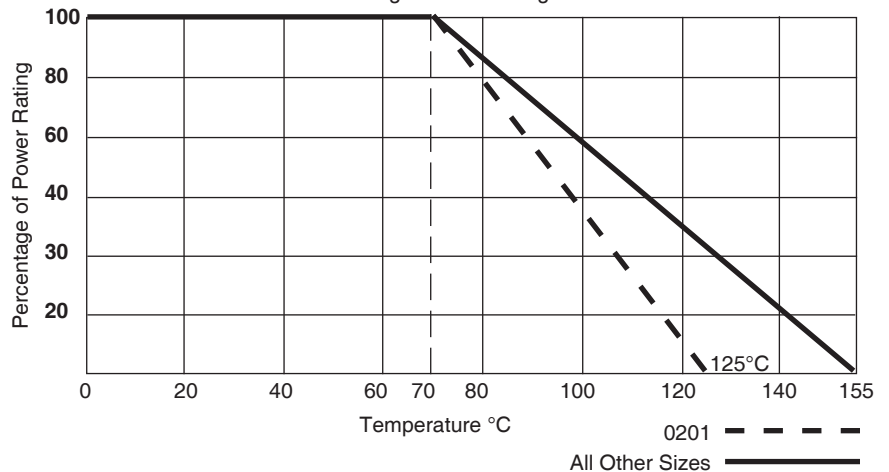

## ENVIRONMENTAL CHARACTERISTICS

Item	Specification		Typical			Test Method*
	Tol. ≤ 0.05%	Tol. > 0.05%	Tol. > 0.05%			
			0402	0603	0805	
Standard Temperature Range: -55°C ~ +155°C (power derating above +70°C)						
Temperature Coefficient of Resistance	As specified	As specified	-	-	-	+25/-55/+25/+125/+25
Short Time Overload	$\Delta R \pm 0.05\%$	$\Delta R \pm 0.2\%$	-0.001%	-0.002%	-0.005%	RCWV x 2.5 or Max Overloading Voltage for 5 Seconds
Dielectric Withstanding Voltage	As specified		265V	298V	415V	MIL-STD-202F Method 301 Apply Max. Overload Voltage for 1 minute
Insulation Resistance	>1000M $\Omega$		>10G $\Omega$			MIL-STD-202F Method 302 Apply 100Vdc for 1 minute
Thermal Shock (N/A 0201 Size)	$\Delta R \pm 0.05\%$	$\Delta R \pm 0.25\%$	0.001%	-0.02%	0.002%	MIL-STD-202F Method 107G -55°C ~ +150°C, 100 cycles
Load Life	$\Delta R \pm 0.05\%$	$\Delta R \pm 0.2\%$	no change			MIL-STD-202F Method 108A RCWV +70°C, 1.5 hours ON, 0.5 hours OFF Total time 1,000 ~ 1,048 hours
	>7K $\Omega$ $\Delta R \pm 0.5\%$		0.02%	0.03%	0.06%	
Humidity (Steady State)	$\Delta R \pm 0.05\%$	$\Delta R \pm 0.3\%$	0.003%	0.005%	0.007%	MIL-STD-202F Method 103B +40°C, 90% ~ 95% RH, RCWV 1.5 hours ON, 0.5 hours OFF Total time 1,000 ~ 1,048 hours
Resistance to Dry Heat (N/A 0201 Size)	$\Delta R \pm 0.05\%$	$\Delta R \pm 0.5\%$	0.07%	0.02%	0.025%	MIL-STD-202 Method 108 +125°C, 1000 hours
Low Temperature Operation (N/A 0201 Size)	$\Delta R \pm 0.05\%$	$\Delta R \pm 0.2\%$	0.006%	0.008%	0.001%	JIS-C-502-7.1 1 hour @ -65°C followed by 45 minutes of RCWV
Bending Strength	$\Delta R \pm 0.05\%$	$\Delta R \pm 0.2\%$	0.001%	-0.010%	0.002%	JIS-C-5202-6.1.4 Bending Amplitude 3mm for 10 seconds
Solderability	95% Minimum Coverage		>95%			MIL-STD-202F Method 208H 245°C $\pm 5^\circ\text{C}$ , 5 $\pm 0.5$ seconds
Resistance to Soldering Heat	$\Delta R \pm 0.05\%$	$\Delta R \pm 0.2\%$	0.001%	-0.02%	0.006%	MIL-STD-202F Method 210E 260°C $\pm 5^\circ\text{C}$ for 10 $\pm 1$ seconds

\*0201 testing per IEC 60115 - 1



## STANDARD E-24, E-96 AND E-192 VALUES AND 0603 RESISTANCE CODES

E-24		E-96								E-192*					
Value	Code	Value	Code	Value	Code	Value	Code	Value	Code	Value	Value	Value	Value	Value	Value
100	01	100	02	105	03	107	04	100	147	215	316	464	681		
110	05	113	06	115	07	118	08	101	149	218	320	470	690		
120	09	124	10	127	11	130	12	102	150	221	324	475	698		
130	13	137	14	140	15	143	16	104	152	223	328	481	706		
150	17	150	18	154	19	158	20	105	154	226	332	487	715		
160	21	165	22	169	23	174	24	106	156	229	336	493	723		
180	25	182	26	187	27	191	28	107	158	232	340	499	732		
200	29	200	30	205	31	210	32	109	160	234	344	505	741		
220	33	221	34	226	35	232	36	110	162	237	348	511	750		
240	37	243	38	249	39	255	40	111	164	240	352	517	759		
270	41	267	42	274	43	280	44	113	165	243	357	523	768		
300	45	294	46	301	47	309	48	114	167	246	361	530	777		
330	49	324	50	332	51	340	52	115	169	249	365	536	787		
360	53	357	54	365	55	374	56	117	172	252	370	542	796		
390	57	392	58	402	59	412	60	118	174	255	374	549	806		
430	61	432	62	442	63	453	64	120	176	258	379	556	816		
470	65	475	66	487	67	499	68	121	178	261	383	562	825		
510	69	523	70	536	71	549	72	123	180	264	388	569	835		
560	73	576	74	590	75	604	76	124	182	267	392	576	845		
620	77	634	78	649	79	665	80	126	184	271	397	583	856		
680	81	698	82	715	83	732	84	127	187	274	402	590	866		
750	85	768	86	787	87	806	88	129	189	270	407	597	876		
820	89	845	90	866	91	887	92	130	191	280	412	604	887		
910	93	931	94	953	95	976	96	132	193	284	417	612	898		
								133	196	287	422	619	909		
								135	198	291	427	626	920		
								137	200	294	432	634	931		
								138	203	298	437	642	942		
								140	205	301	442	649	953		
								142	208	305	448	657	965		
								143	210	309	453	665	976		
								145	213	312	459	673	988		

\* Special E192 resistance values are supported on all case sizes of NTR series. Please review your E192 value requirements with NIC, as special terms apply, and E192 values are supplied without component resistance value marking.

### MULTIPLIER CODE

Code	A	B, b	C	D, d	E	F	G	H	X	Y	Z
Multiplier	10 <sup>0</sup>	10 <sup>1</sup>	10 <sup>2</sup>	10 <sup>3</sup>	10 <sup>4</sup>	10 <sup>5</sup>	10 <sup>6</sup>	10 <sup>7</sup>	10 <sup>-1</sup>	10 <sup>-2</sup>	10 <sup>-3</sup>



## PART MARKING

- No marking on 0402 case size.
- Marking for 0603 case size:  
 E-24 values and E-96 values:  $\pm 1\%$  (F),  $\pm 0.5\%$  (D),  $\pm 0.25\%$  (C),  $\pm 0.1\%$  (B) tolerances  
 E-192 values:  $\pm 0.1\%$  (B) tolerance (No Marking)

### CODING FORMULA

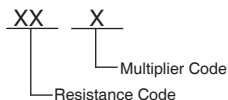

Example:  $10.2k\Omega = \frac{102}{02} \times \frac{10^2}{C} \Omega = 02C$   
 $33.2 \Omega = \frac{332}{51} \times \frac{10^{-1}}{X} = 51X$

### MARKING EXAMPLES

10 $\Omega$  = 01X  
 7.5k  $\Omega$  = 85B  
 150k  $\Omega$  = 18D  
 1 Meg $\Omega$  = 01E

- Marking for 0805, 1206, 2010 and 2512 case sizes:  
 E-24 and E-96 values -  $\pm 1\%$ (F),  $\pm 0.5\%$ (D),  $\pm 0.25\%$ (C),  $\pm 0.1\%$  (B) tolerances  
 E-192 values:  $\pm 0.1\%$  (B) tolerance (No Marking)

4 DIGIT MARKING SYSTEM - First 3 digits are the significant figures, the 4th digit is the multiplier. "R"= decimal point.

Examples: 0R10 = 0.10 ohms, 1R00 = 1.0 ohms, 22R1=22.1 ohms, 3320= 332 ohms, 4751=4.75K ohms, 1132=11.3K ohms, 6493=649K ohms

### PART NUMBER SYSTEM

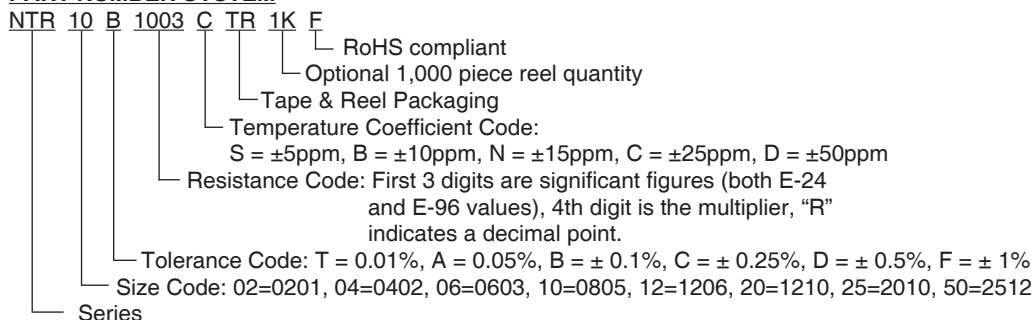

## DIMENSIONS (mm)

Type	Power Rating	EIA Size	L	W	H	T	t
NTR02	1/32W	0201	0.58 ± 0.05	0.29 ± 0.05	0.23 ± 0.03	0.12 ± 0.05	0.15 ± 0.05
NTR04	1/16W	0402	1.00 ± 0.05	0.50 ± 0.05	0.30 ± 0.05	0.20 ± 0.10	0.20 ± 0.10
NTR06	1/16W	0603	1.55 ± 0.10	0.80 ± 0.10	0.45 ± 0.10	0.30 ± 0.20	0.30 ± 0.20
NTR10	1/10W	0805	2.00 ± 0.15	1.25 ± 0.15	0.55 ± 0.10	0.30 ± 0.20	0.40 ± 0.25
NTR12	1/8W	1206	3.05 ± 0.10	1.55 ± 0.10	0.55 ± 0.10	0.42 ± 0.20	0.35 ± 0.25
NTR20	1/4W	1210	3.10 ± 0.15	2.40 ± 0.15	0.55 ± 0.10	0.40 ± 0.20	0.55 ± 0.25
NTR25	1/4W	2010	4.90 ± 0.15	2.40 ± 0.15	0.55 ± 0.10	0.60 ± 0.30	0.50 ± 0.25
NTR50	1/2W	2512	6.30 ± 0.15	3.10 ± 0.15	0.55 ± 0.10	0.60 ± 0.30	0.50 ± 0.25

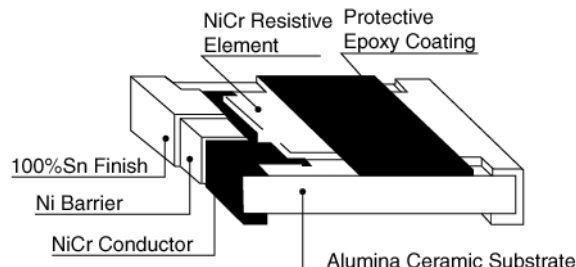
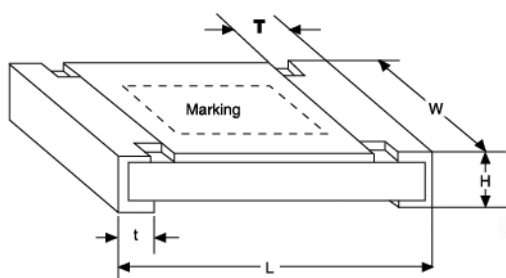

## TAPING SPECIFICATIONS

### (1) Availability

Type	Power Rating	EIA Size	Carrier Tape			Qty per Reel (pcs)	
			Fig.	Material	Width (mm)	Standard	Optional
NTR02	1/32W	0201	A	Paper	8	10,000	1,000
NTR04	1/16W	0402	A			10,000	1,000
NTR06	1/16W	0603	A			5,000	1,000
NTR10	1/10W	0805	A				
NTR12	1/8W	1206	A				
NTR20	1/4W	1210	A			Plastic	12
NTR25	1/4W	2010	B				
NTR50	1/2W	2512	B				

### (2) PAPER TAPE DIMENSIONS (mm)

FIG. A

Type	EIA Size	A	B	D	E	F	P <sub>0</sub>	P <sub>1</sub>	P <sub>2</sub>	W	T
NTR02	0201	0.40 ± 0.05	0.70 ± 0.05	1.55 ± 0.05	1.75 ± 0.05	3.50 ± 0.05	4.0 ± 0.10	2.0 ± 0.05	2.0 ± 0.05	8.0 ± 0.1	0.42 ± 0.02
NTR04	0402	0.70 ± 0.05	1.16 ± 0.05					0.40 ± 0.03			
NTR06	0603	1.10 ± 0.05	1.90 ± 0.05					0.60 ± 0.03			
NTR10	0805	1.60 ± 0.05	2.37 ± 0.05					0.75 ± 0.05			
NTR12	1206	2.00 ± 0.05	3.55 ± 0.05	1.60 ± 0.10							
NTR20	1210	2.75 ± 0.05	3.40 ± 0.05								

FIG. A

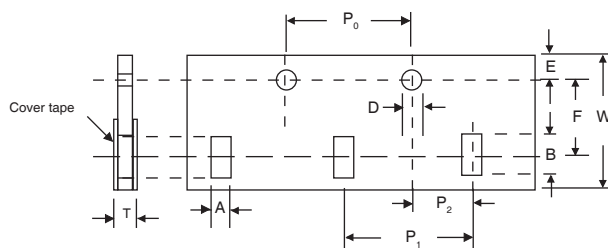

### (3) PLASTIC EMBOSSED TAPE DIMENSIONS (mm)

FIG. B

Type	EIA Size	A	B	D	E	F	P <sub>0</sub>	P <sub>1</sub>	P <sub>2</sub>	W	T
NTR25	2010	2.85 ± 0.10	5.45 ± 0.10	1.50 ± 0.10	1.75 ± 0.10	5.50 ± 0.05	4.0 ± 0.10	4.0 ± 0.05	2.0 ± 0.05	12.0 ± 0.1	1.0 ± 0.20
NTR50	2512	3.40 ± 0.10	6.65 ± 0.10								

FIG. B

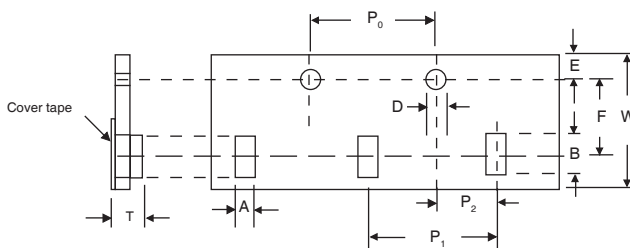

## REEL DIMENSIONS (mm)

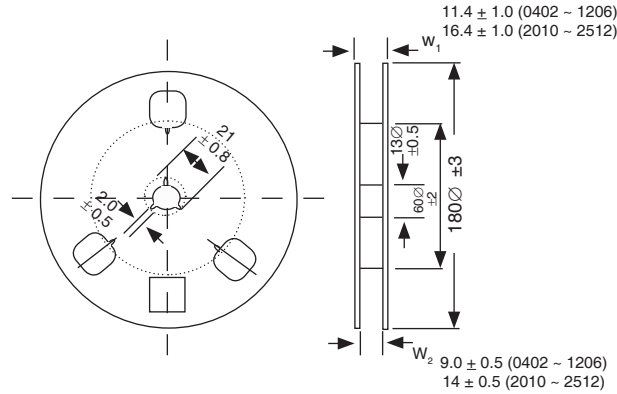

## LAND PATTERN DIMENSIONS (mm)

Type	EIA Size	A	B	C
NTR02	0201	0.25	0.30	0.40 ± 0.2
NTR04	0402	0.50	0.50	0.60 ± 0.2
NTR06	0603	0.80	1.00	0.90 ± 0.2
NTR10	0805	1.00	1.00	1.35 ± 0.2
NTR12	1206	2.00	1.15	1.70 ± 0.2
NTR20	1210	2.00	1.15	2.50 ± 0.2
NTR25	2010	3.60	1.40	2.50 ± 0.2
NTR50	2512	4.90	1.60	3.10 ± 0.2

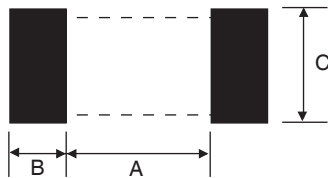

## PEAK REFLOW SOLDERING CONDITIONS

