



DC COMPONENTS CO., LTD.

RECTIFIER SPECIALISTS

**1.5KE6.8
THRU
1.5KE440CA**

TECHNICAL SPECIFICATIONS OF TRANSIENT VOLTAGE SUPPRESSOR

VOLTAGE RANGE - 6.8 to 440 Volts

PEAK PULSE POWER - 1500 Watts

FEATURES

- * Glass passivated junction
- * 1500 Watts Peak Pulse Power capability on 10/1000 μ s waveform
- * Excellent clamping capability
- * Low zener impedance
- * Fast response time

MECHANICAL DATA

- * Case: Molded plastic
- * Epoxy: UL 94V-0 rate flame retardant
- * Lead: MIL-STD-202E, Method 208 guaranteed
- * Polarity: Color band denotes positive end (cathode) except bidirectional types
- * Mounting position: Any
- * Weight: 1.2 gram

MAXIMUM RATINGS AND ELECTRICAL CHARACTERISTICS

Ratings at 25°C ambient temperature unless otherwise specified.
Single phase, half wave, 60 Hz, resistive or inductive load,
For capacitive load, derate current by 20%.

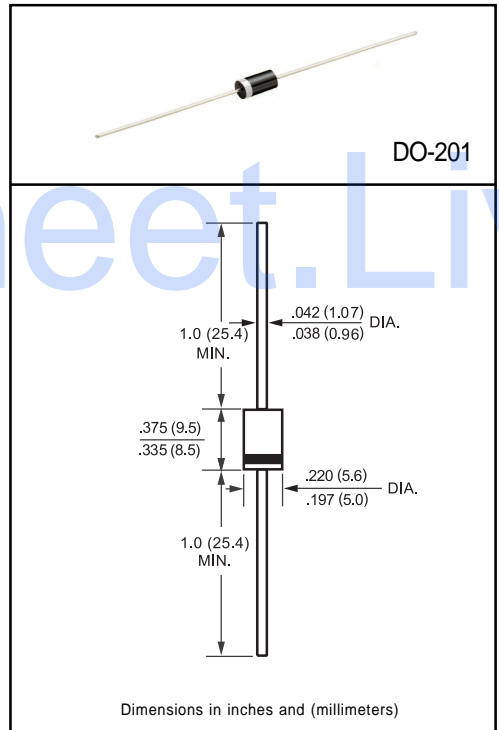

DEVICES FOR BIPOLAR APPLICATIONS

For Bidirectional use C or CA suffix (e.g. 1.5KE6.8C, 1.5KE440CA)

Electrical characteristics apply in both directions

	SYMBOL	VALUE	UNITS
Peak Pulse Power Dissipation on 10/1000 us waveform (Note 1, FIG. 1)	PPPM	Minimum 1500	Watts
Steady State Power Dissipation at $T_L = 75^\circ\text{C}$ Lead Lengths .375" (9.5 mm) (Note 2)	$P_{M(AV)}$	5.0	Watts
Peak Forward Surge Current, 8.3ms single half sine-wave superimposed on rated load(JEDEC Method) (Note 3)	I_{FSM}	200	Amps
Maximum Instantaneous Forward Voltage at 50A for unidirectional only (Note 4)	V_F	3.5/5.0	Volts
Operating and Storage Temperature Range	T_J, T_{STG}	-55 to + 175	$^\circ\text{C}$

- NOTES : 1. Non-repetitive current pulse, per Fig.3 and derated above $T_A = 25^\circ\text{C}$ per Fig.2.
2. Mounted on Copper Leaf area of 1.6 X 1.6" (40 X 40mm) per Fig. 5
3. 8.3ms single half sine-wave or equivalent square wave, duty cycle = 4 pulses per minute maximum.
4. $V_F = 3.5\text{V max.}$ for devices of $V_{(BR)} \leq 200\text{V}$ and $V_F = 5.0\text{V max.}$ for devices of $V_{(BR)} > 200\text{V}$.

RATING AND CHARACTERISTIC CURVES (1.5KE6.8 THRU 1.5KE440CA)

FIG. 1 - PULSE POWER RATING CURVE

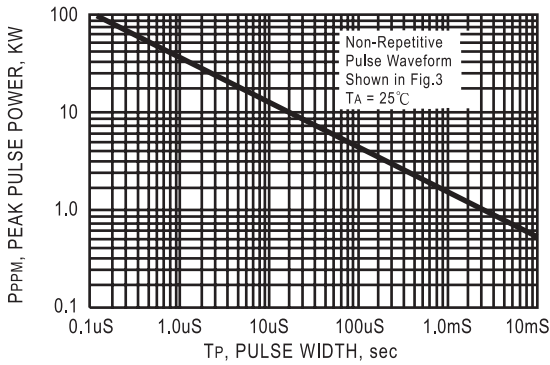

FIG. 2 - PULSE DERATING CURVE

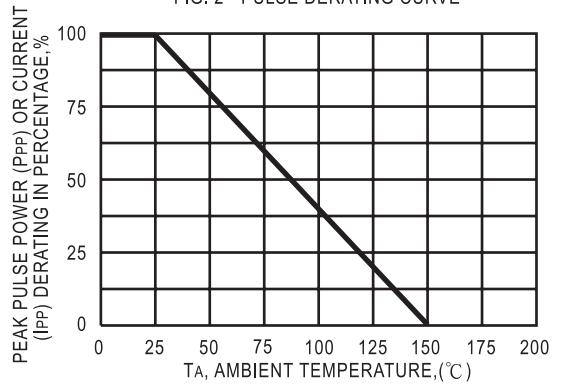

FIG. 3 - PULSE WAVEFORM

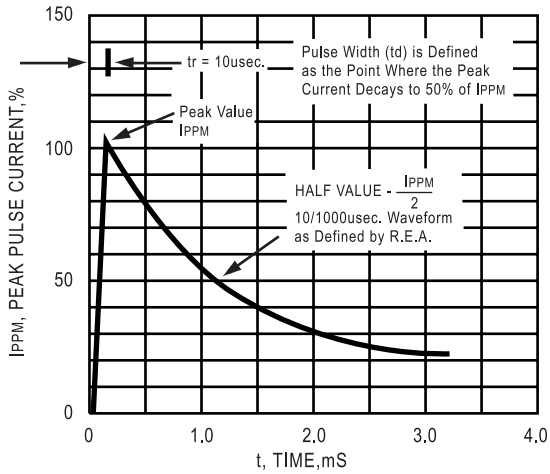

FIG. 4 - TYPICAL JUNCTION CAPACITANCE

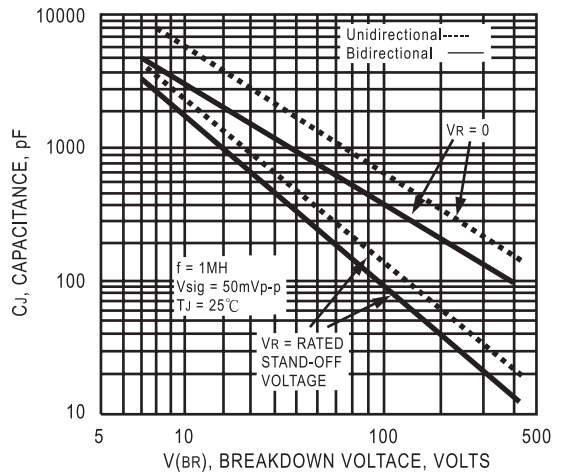

FIG. 5 - STEADY STATE POWER DERATING CURVE

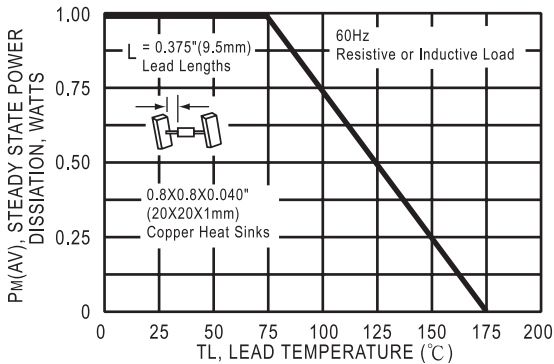
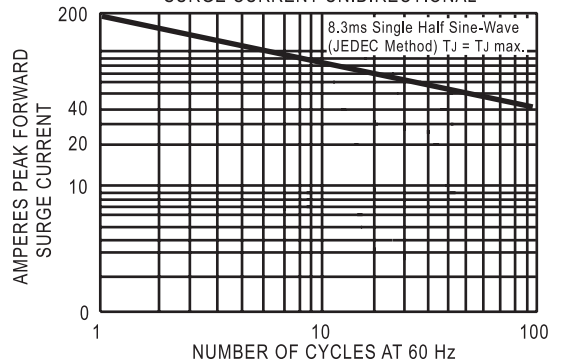

FIG. 6 - MAXIMUM NON-REPETITIVE FORWARD SURGE CURRENT UNIDIRECTIONAL



1.5KW (1500W) SERIES TRANSIENT VOLTAGE SUPPRESSORS

TYPE	JEDEC PART NUMBER	Breakdown Voltage			Reverse Stand off Voltage VWM (Volts)	Maximum Reverse Leakage at VWM Id(uA)	Maximum Peak Pulse Current IPPM (Amps)	Maximum Clamping Voltage at IPPM Vc (Volts)
		VBR (Volts)		@IT (mA)				
		MIN.	MAX.					
1.5KE6.8	1N6267	6.12	7.48	10	5.50	1000	139	10.8
1.5KE6.8A	1N6267A	6.45	7.14	10	5.80	1000	142	10.5
1.5KE7.5	1N6268	6.75	8.25	10	6.05	500	128	11.7
1.5EK7.5A	1N6268A	7.13	7.88	10	6.40	500	132	11.3
1.5KE8.2	1N6269	7.38	9.02	10	6.63	200	120	12.5
1.5KE8.2A	1N6269A	7.79	8.61	10	7.02	200	124	12.1
1.5KE9.1	1N6270	8.19	10.0	1.0	7.37	50	109	13.8
1.5KE9.1A	1N6270A	8.65	9.55	1.0	7.78	50	112	13.4
1.5KE10	1N6271	9.00	11.0	1.0	8.10	10	100	15.0
1.5EK10A	1N6271A	9.50	10.5	1.0	8.55	10	103	14.5
1.5KE11	1N6272	9.90	12.1	1.0	8.92	5.0	93.0	16.2
1.5KE11A	1N6272A	10.5	11.6	1.0	9.40	5.0	96.0	15.6
1.5KE12	1N6273	10.8	13.2	1.0	9.72	5.0	87.0	17.3
1.5KE12A	1N6273A	11.4	12.6	1.0	10.2	5.0	90.0	16.7
1.5KE13	1N6274	11.7	14.3	1.0	10.5	5.0	79.0	19.0
1.5KE13A	1N6274A	12.4	13.7	1.0	11.1	5.0	82.0	18.2
1.5KE15	1N6275	13.5	16.5	1.0	12.1	5.0	68.0	22.0
15.KE15A	1N6275A	14.3	15.8	1.0	12.8	5.0	71.0	21.2
1.5KE16	1N6276	14.3	17.6	1.0	12.9	5.0	64.0	23.5
1.5KE16A	1N6276A	15.2	16.8	1.0	13.6	5.0	67.0	22.5
1.5KE18	1N6277	16.2	19.8	1.0	14.5	5.0	56.5	26.5
1.5KE18A	1N6277A	17.1	18.9	1.0	15.3	5.0	59.5	25.2
1.5KE20	1N6278	18.0	22.0	1.0	16.2	5.0	51.5	29.1
1.5KE20A	1N6278A	19.0	21.0	1.0	17.1	5.0	54.0	27.7
1.5KE22	1N6279	19.8	24.2	1.0	17.8	5.0	47.0	31.9
1.5KE22A	1N6279A	20.9	23.1	1.0	18.8	5.0	49.0	30.6
1.5KE24	1N6280	21.6	26.4	1.0	19.4	5.0	43.0	34.7
1.5KE24A	1N6280A	22.8	25.2	1.0	20.5	5.0	45.0	33.2
1.5KE27	1N6281	24.3	29.7	1.0	21.8	5.0	38.5	39.1
1.5KE27A	1N6281A	25.7	28.4	1.0	23.1	5.0	40.0	37.5
1.5KE30	1N6282	27.0	33.0	1.0	24.3	5.0	35.5	43.5
1.5KE30A	1N6282A	28.5	31.5	1.0	25.6	5.0	36.0	41.4
1.5KE33	1N6283	29.7	36.3	1.0	26.8	5.0	31.5	47.7
1.5KE33A	1N6283A	31.4	34.7	1.0	28.2	5.0	33.0	45.7
1.5KE36	1N6284	32.4	39.6	1.0	29.1	5.0	29.0	52.0
1.5KE36A	1N6284A	34.2	37.8	1.0	30.8	5.0	30.0	49.9
1.5KE39	1N6285	35.1	42.9	1.0	31.6	5.0	26.5	56.4
1.5KE39A	1N6285A	37.1	41.0	1.0	33.3	5.0	28.0	53.9
1.5.KE43	1N6286	38.7	47.3	1.0	34.8	5.0	24.0	61.9
1.5.KE43A	1N6286A	40.9	45.2	1.0	36.8	5.0	25.3	59.3
1.5KE47	1N6287	42.3	51.7	1.0	38.1	5.0	22.2	67.8
1.5KE47A	1N6287A	44.7	49.4	1.0	40.2	5.0	23.2	64.8
1.5KE51	1N6288	45.9	56.1	1.0	41.3	5.0	20.4	73.5
1.5KE51A	1N6288A	48.5	53.6	1.0	43.6	5.0	21.4	70.1



DC COMPONENTS CO., LTD.

1.5KW (1500W) SERIES TRANSIENT VOLTAGE SUPPRESSORS

TYPE	JEDEC PART NUMBER	Breakdown Voltage			Reverse Stand off Voltage V _{WM} (Volts)	Maximum Reverse Leakage at V _{WM} I _D (uA)	Maximum Peak Pulse Current I _{PPM} (Amps)	Maximum Clamping Voltage at I _{PPM} V _C (Volts)
		V _{BR} (Volts)		@I _T (mA)				
		MIN.	MAX.					
1.5KE56	1N6289	50.4	61.6	1.0	45.4	5.0	18.6	80
1.5KE56A	1N6289A	53.2	58.8	1.0	47.8	5.0	19.5	77
1.5KE62	1N6290	55.8	68.2	1.0	50.2	5.0	16.9	89
1.5KE62A	1N6290A	58.9	65.1	1.0	53.0	5.0	17.7	85
1.5KE68	1N6291	61.2	74.8	1.0	55.1	5.0	15.3	98
1.5KE68A	1N6291A	64.6	71.4	1.0	58.1	5.0	16.3	92
1.5KE75	1N6292	67.5	82.8	1.0	60.7	5.0	13.9	108
1.5KE75A	1N6292A	71.3	78.8	1.0	64.1	5.0	14.6	103
1.5KE82	1N6293	73.8	90.2	1.0	66.4	5.0	12.7	118
1.5KE82A	1N6293A	77.9	86.1	1.0	70.1	5.0	13.3	113
1.5KE91	1N6294	81.9	100	1.0	73.7	5.0	11.4	131
1.5KE91A	1N6294A	86.5	95.5	1.0	77.8	5.0	12.0	125
1.5KE100	1N6295	90.0	110	1.0	81.0	5.0	10.4	144
1.5KE100A	1N6295A	95.0	105	1.0	85.5	5.0	11.0	137
1.5KE110	1N6296	99.0	121	1.0	89.2	5.0	9.5	158
1.5KE110A	1N6296A	105	116	1.0	94.0	5.0	9.9	152
1.5KE120	1N6297	108	132	1.0	97.2	5.0	8.7	173
1.5KE120A	1N6297A	114	126	1.0	102	5.0	9.1	165
1.5KE130	1N6298	117	143	1.0	105	5.0	8.0	187
1.5KE130A	1N6298A	124	137	1.0	111	5.0	8.4	179
1.5KE150	1N6299	135	165	1.0	121	5.0	7.0	215
1.5KE150A	1N6299A	143	158	1.0	128	5.0	7.2	207
1.5KE160	1N6300	144	176	1.0	130	5.0	6.5	230
1.5KE160A	1N6300A	152	168	1.0	136	5.0	6.8	219
1.5KE170	1N6301	153	187	1.0	138	5.0	6.2	244
1.5KE170A	1N6301A	162	179	1.0	145	5.0	6.4	234
1.5KE180	1N6302	162	198	1.0	146	5.0	5.8	258
1.5KE180A	1N6302A	171	189	1.0	154	5.0	6.1	246
1.5KE200	1N6303	180	220	1.0	162	5.0	5.21	287
1.5KE200A	1N6303A	190	210	1.0	171	5.0	5.5	274
1.5KE220		198	242	1.0	175	5.0	4.3	344
1.5KE220A		209	231	1.0	185	5.0	4.6	328
1.5KE250		225	275	1.0	202	5.0	5.0	360
1.5KE250A		237	263	1.0	214	5.0	5.0	344
1.5KE300		270	339	1.0	243	5.0	5.0	430
1.5KE300A		285	315	1.0	256	5.0	5.0	414
1.5KE350		315	385	1.0	284	5.0	5.0	504
1.5KE350A		332	368	1.0	300	5.0	4.0	482
1.5KE400		360	440	1.0	324	5.0	4.0	572
1.5KE400A		380	420	1.0	342	5.0	4.0	548
1.5KE440		396	484	1.0	356	5.0	2.3	630
1.5KE440A		418	462	1.0	376	5.0	2.3	600

- NOTES : 1.V_{BR} measured after I_T applied for 300μs. I_T= Square Wave Pulse or equivalent.
 2.For bidirectional use C or CA suffixes for all types (ex. 1.5KE6.8C, 1.5KE440CA).
 electrical characteristics apply in both directions.
 3.For bidirectional types having V_{WM} of 10 volts and less, the I_D limit is doubled.



DC COMPONENTS CO., LTD.