



5KP5.0 thru 5KP110A

Transient Voltage Suppressors
Peak Pulse Power 5000W Stand-off Voltage 5.0 to 110V

Features

- ◆ Plastic package has Underwriters Laboratory Flammability Classification 94V-0
- ◆ Glass passivated junction
- ◆ 5000W peak pulse power capability with a 10/1000ms waveform, repetition rate (duty cycle): 0.05%
- ◆ Excellent clamping capability
- ◆ Low incremental surge resistance
- ◆ Fast response time: theoretically (with no parasitic inductance) less than 1ps from 0 Volts to $V_{(BR)}$ for unidirectional and 5ns for bidirectional types.
- ◆ Devices with $V_{(BR)} > 10V$ I_D are typically I_D less than 1.0mA
- ◆ High temperature soldering guaranteed:
265°C/10 seconds, 0.375" (9.5mm) lead length, 5lbs. (2.3 kg) tension

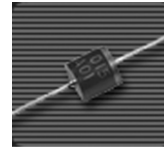

R-6 or P600

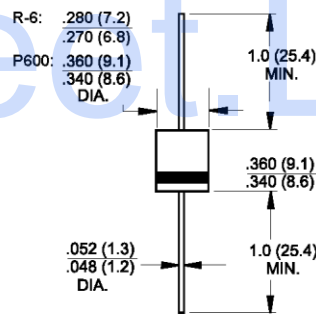

Dimensions in inches and (millimeters)

Mechanical Data

- ◆ Case: Molded plastic body over glass passivated junction
- ◆ Terminals: Solder plated axial leads, solderable per MIL-STD-750, Method 2026
- ◆ Polarity: The color band denotes the cathode, which is positive with respect to the anode under normal TVS operation
- ◆ Mounting Position: Any
- ◆ Weight: 0.07 ounce, 2.1 grams

Maximum Ratings and Thermal Characteristics

Ratings at 25°C ambient temperature unless otherwise specified.

Parameter	Symbol	Value	Unit
Peak pulse power dissipation with a 10/1000us waveform ⁽¹⁾	P_{PPM}	Minimum 5000	W
Peak pulse current with a 10/1000us waveform ⁽¹⁾	I_{PPM}	See Next Table	A
Steady state power dissipation at $T_A=75^\circ\text{C}$, lead lengths 0.375" (9.5mm) ⁽²⁾	$P_{M(AV)}$	8.0	W
Peak forward surge current, 8.3ms single half sine-wave ⁽³⁾	I_{FSM}	500	Amps
Instantaneous forward voltage at 100A ⁽³⁾	V_F	3.5	Volts
Operating junction and storage temperature range	$T_{J, T_{STG}}$	-55 to +175	°C

- Notes:**
1. Non-repetitive current pulse, per Fig.3 and derated above $T_A=25^\circ\text{C}$ per Fig. 2
 2. Mounted on copper pad area of 1.6 x 1.6" (40 x 40 mm) per Fig. 5.
 3. Measured on 8.3ms single half sine-wave or equivalent square wave, duty cycle = 4 pulses per minute maximum.

Electrical Characteristics

($T_A = 25^\circ\text{C}$ unless otherwise noted.)

Device type	Breakdown voltage $V_{(BR)}$ (Volts) ⁽¹⁾		Test current at I_T (mA)	Stand-off voltage V_{WM} (Volts)	Maximum reverse leakage at V_{WM} I_D (μA)	Maximum peak pulse current $I_{PPM}^{(2)}$ (A)	Maximum clamping voltage at I_{PPM} V_C (Volts)	Maximum temperature coefficient of $V_{(BR)}$ (% / $^\circ\text{C}$)
	Min.	Max.						
5KP5.0	6.40	7.30	50	5.0	2000	521	9.6	0.057
5KP5.0A	6.40	7.00	50	5.0	2000	543	9.2	0.057
5KP6.0	6.67	8.15	50	6.0	5000	439	11.4	0.061
5KP6.0A	6.67	7.37	50	6.0	5000	485	10.3	0.061
5KP6.5	7.22	8.82	50	6.5	2000	407	12.3	0.065
5KP6.5A	7.22	7.98	50	6.5	2000	446	11.2	0.065
5KP7.0	7.78	9.51	50	7.0	1000	376	13.3	0.068
5KP7.0A	7.78	8.60	50	7.0	1000	417	12.0	0.068
5KP7.5	8.33	10.2	5.0	7.5	250	350	14.3	0.073
5KP7.5A	8.33	9.21	5.0	7.5	250	388	12.9	0.073
5KP8.0	8.89	10.9	5.0	8.0	150	333	15.0	0.075
5KP8.0A	8.89	9.83	5.0	8.0	150	368	13.6	0.075
5KP8.5	9.44	11.5	5.0	8.5	50	314	15.9	0.078
5KP8.5A	9.44	10.4	5.0	8.5	50	347	14.4	0.078
5KP9.0	10.0	12.2	5.0	9.0	20	296	16.9	0.081
5KP9.0A	10.0	11.1	5.0	9.0	20	325	15.4	0.081
5KP10	11.1	13.6	5.0	10.0	15	266	18.8	0.084
5KP10A	11.1	12.3	5.0	10.0	15	294	17.0	0.084
5KP11	12.2	14.9	5.0	11.0	10	249	20.1	0.086
5KP11A	12.2	13.5	5.0	11.0	10	275	18.2	0.086
5KP12	13.3	16.3	5.0	12.0	5.0	227	22.0	0.088
5KP12A	13.3	14.7	5.0	12.0	5.0	251	19.9	0.088
5KP13	14.4	17.6	5.0	13.0	2.0	210	23.8	0.090
5KP13A	14.4	15.9	5.0	13.0	2.0	233	21.5	0.090
5KP14	15.6	19.1	5.0	14.0	2.0	194	25.8	0.092
5KP14A	15.6	17.2	5.0	14.0	2.0	216	23.2	0.092
5KP15	16.7	20.4	5.0	15.0	2.0	186	26.9	0.094
5KP15A	16.7	18.5	5.0	15.0	2.0	205	24.4	0.094
5KP16	17.8	21.8	5.0	16.0	2.0	174	28.8	0.096
5KP16A	17.8	19.7	5.0	16.0	2.0	192	26.0	0.096
5KP17	18.9	23.1	5.0	17.0	2.0	164	30.5	0.097
5KP17A	18.9	20.9	5.0	17.0	2.0	181	27.6	0.097
5KP18	20.0	24.4	5.0	18.0	2.0	155	32.2	0.098
5KP18A	20.0	22.1	5.0	18.0	2.0	171	29.2	0.098
5KP20	22.2	27.1	5.0	20.0	2.0	140	35.8	0.099
5KP20A	22.2	24.5	5.0	20.0	2.0	154	32.4	0.099
5KP22	24.4	29.8	5.0	22.0	2.0	127	39.4	0.100
5KP22A	24.4	26.9	5.0	22.0	2.0	141	35.5	0.100
5KP24	26.7	32.6	5.0	24.0	2.0	116	43.0	0.101
5KP24A	26.7	29.5	5.0	24.0	2.0	129	38.9	0.101
5KP26	28.9	35.3	5.0	26.0	2.0	107	46.6	0.101
5KP26A	28.9	31.9	5.0	26.0	2.0	119	42.1	0.101
5KP28	31.1	38.0	5.0	28.0	2.0	100	50.0	0.102
5KP28A	31.1	34.4	5.0	28.0	2.0	110	45.4	0.102
5KP30	33.3	40.7	5.0	30.0	2.0	93.5	53.5	0.103
5KP30A	33.3	36.8	5.0	30.0	2.0	103	48.4	0.103

Electrical Characteristics

($T_A=25^\circ\text{C}$ unless otherwise noted.)

Device type	Breakdown voltage $V_{(BR)}$ (Volts) ⁽¹⁾		Test current at I_T (mA)	Stand-off voltage V_{WM} (Volts)	Maximum reverse leakage at V_{WM} I_D (μA)	Maximum peak pulse current $I_{PPM}^{(2)}$ (A)	Maximum clamping voltage at I_{PPM} V_C (Volts)	Maximum temperature coefficient of $V_{(BR)}$ (% / $^\circ\text{C}$)
	Min.	Max.						
5KP33	36.7	44.9	5.0	33.0	2.0	84.7	59.0	0.104
5KP33A	36.7	40.6	5.0	33.0	2.0	93.8	53.3	0.104
5KP36	40.0	48.9	5.0	36.0	2.0	77.8	64.3	0.104
5KP36A	40.0	44.2	5.0	36.0	2.0	86.1	58.1	0.104
5KP40	44.4	54.3	5.0	40.0	2.0	70.0	71.4	0.105
5KP40A	44.4	49.1	5.0	40.0	2.0	77.5	64.5	0.105
5KP43	47.8	58.4	5.0	43.0	2.0	65.2	76.7	0.105
5KP43A	47.8	52.8	5.0	43.0	2.0	72.0	69.4	0.105
5KP45	50.0	61.1	5.0	45.0	2.0	62.3	80.3	0.106
5KP45A	50.0	55.3	5.0	45.0	2.0	68.8	72.7	0.106
5KP48	53.3	65.2	5.0	48.0	2.0	58.5	85.5	0.106
5KP48A	53.3	58.9	5.0	48.0	2.0	64.6	77.4	0.106
5KP51	56.7	69.3	5.0	51.0	2.0	54.9	91.1	0.107
5KP51A	56.7	62.7	5.0	51.0	2.0	60.7	82.4	0.107
5KP54	60.0	73.3	5.0	54.0	2.0	51.9	96.3	0.107
5KP54A	60.0	66.3	5.0	54.0	2.0	57.4	87.1	0.107
5KP58	64.4	78.7	5.0	58.0	2.0	48.5	103	0.107
5KP58A	64.4	71.2	5.0	58.0	2.0	53.4	94	0.107
5KP60	66.7	81.5	5.0	60.0	2.0	46.7	107	0.108
5KP60A	66.7	73.7	5.0	60.0	2.0	51.7	97	0.108
5KP64	71.1	86.9	5.0	64.0	2.0	43.9	114	0.108
5KP64A	71.1	78.6	5.0	64.0	2.0	48.5	103	0.108
5KP70	77.8	95.1	5.0	70.0	2.0	40.0	125	0.108
5KP70A	77.8	86.0	5.0	70.0	2.0	44.2	113	0.108
5KP75	83.3	102	5.0	75.0	2.0	37.3	134	0.108
5KP75A	83.3	92.1	5.0	75.0	2.0	41.3	121	0.108
5KP78	86.7	106	5.0	78.0	2.0	36.0	139	0.108
5KP78A	86.7	95.8	5.0	78.0	2.0	39.7	126	0.108
5KP85	94.4	115	5.0	85.0	2.0	33.1	151	0.108
5KP85A	94.4	104	5.0	85.0	2.0	36.5	137	0.110
5KP90	100	122	5.0	90.0	2.0	31.3	160	0.110
5KP90A	100	111	5.0	90.0	2.0	34.2	146	0.110
5KP100	111	136	5.0	100	2.0	27.9	179	0.110
5KP100A	111	123	5.0	100	2.0	30.9	162	0.110
5KP110	122	149	5.0	110	2.0	25.5	196	0.112
5KP110A	122	135	5.0	110	2.0	28.2	177	0.112

- Notes:**
1. $V_{(BR)}$ measured after I_T applied for 300 μs , I_T =square wave pulse or equivalent
 2. Surge current waveform per Fig. 3 and derate per Fig. 2
 3. All terms and symbols are consistent with ANSI/IEEE CA62.35

Application:

The 5KP series of high power transient voltage suppressors were designed to be used on the output of switching power supplies. These devices may be used to replace crowbar circuits. Both the 5 and 10 percent voltage tolerances are referenced to the power supply output voltage level.

They are able to withstand high levels of peak current while allowing a circuit breaker to trip or a fuse blow before shorting. This will enable the user to reset the breaker or replace the fuse and continue operation. For this type operation, it is recommended that a sufficient mounting surface be used for dissipating the heat generated by the Transient Voltage Suppressor during the transient or over-voltage condition.

Transient Voltage Suppressors are Silicon PN Junction devices designed for absorption of high voltage transients associated with power disturbances, switching and induced lighting effects. This series is available from 5.0 volts thru 110 volts.

RATINGS AND CHARACTERISTIC CURVES

($T_A = 25^\circ\text{C}$ unless otherwise noted)

Fig. 1 - Peak Pulse Power Rating Curve

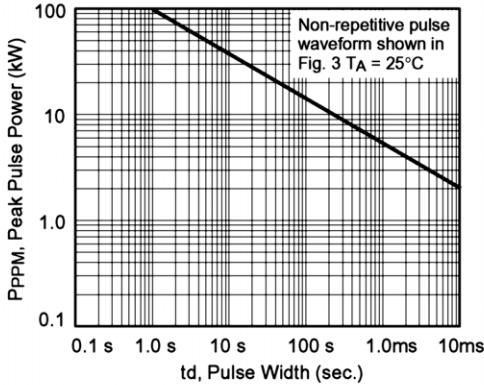

Fig. 2 - Pulse Derating Curve

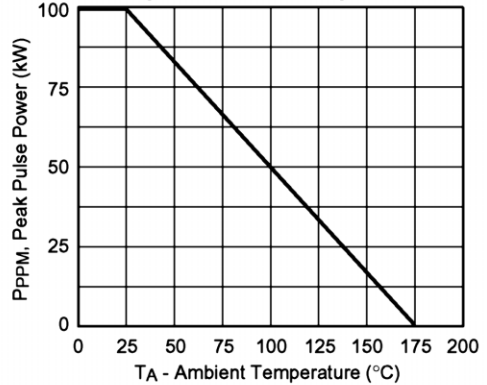

Fig. 3 - Pulse Waveform

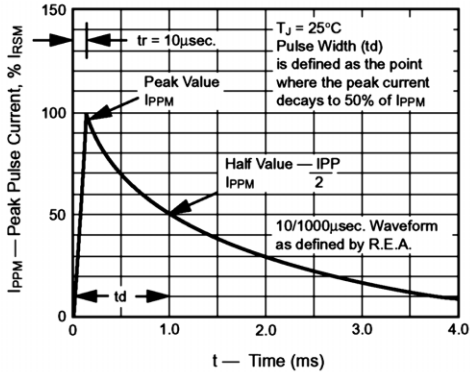

Fig. 4 - Typical Junction Capacitance

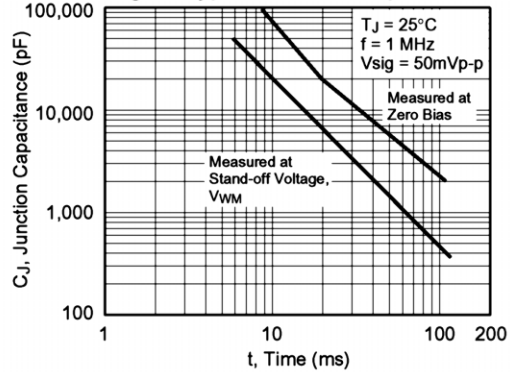

Fig. 5 - Steady State Power Derating Curve

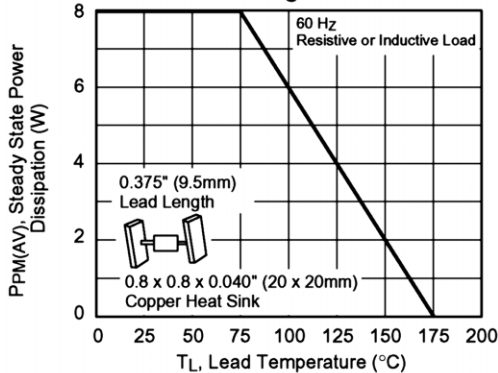

Fig. 6 - Maximum Non-repetitive Forward Surge Current

