

SBL2030CT AND SBL2040CT

SCHOTTKY RECTIFIER

Reverse Voltage - 30 and 40 Volts Forward Current - 20.0 Amperes

TO-220AB

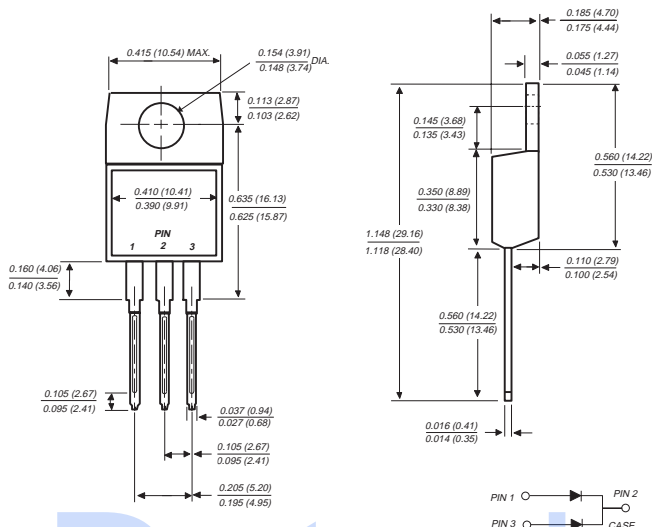

FEATURES

- ◆ Plastic package has Underwriters Laboratory Flammability Classifications 94V-0
- ◆ Metal silicon junction, majority carrier conduction
- ◆ Low power loss, high efficiency
- ◆ High current capability, low forward voltage drop
- ◆ High surge capability
- ◆ For use in low voltage, high frequency inverters, free wheeling, and polarity protection applications
- ◆ Dual rectifier construction, positive center-tap
- ◆ Guardring for overvoltage protection
- ◆ High temperature soldering guaranteed: 250°C/10 seconds, 0.17" (4.3mm) from case

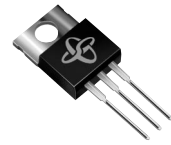

MECHANICAL DATA

Case: JEDEC TO-220AB molded plastic
Terminals: Leads solderable per MIL-STD-750, Method 2026
Polarity: As marked
Mounting Position: Any
Mounting Torque: 5 in. - lbs.max.
Weight: 0.08 ounce, 2.24 grams

MAXIMUM RATINGS AND ELECTRICAL CHARACTERISTICS

Ratings at 25°C ambient temperature unless otherwise specified.

	SYMBOLS	SBL2030CT	SBL2040CT	UNITS
Maximum repetitive peak reverse voltage	V _{RRM}	30	40	Volts
Maximum RMS voltage	V _{RMS}	21	28	Volts
Maximum DC blocking voltage	V _{DC}	30	40	Volts
Maximum average forward rectified current at T _C =105°C	I(AV)	20.0		Amps
Peak forward surge current, 8.3ms single half sine-wave superimposed on rated load (JEDEC Method)	I _{FSM}	175.0		Amps
Peak repetitive reverse surge current (NOTE 3)	I _{RRM}	1.0		Amp
Maximum instantaneous forward voltage per leg at 10.0A (NOTE 1)	V _F	0.55		Volts
Maximum instantaneous current at rated DC blocking voltage per leg (NOTE 1)	I _R	1.0	50.0	mA
Typical thermal resistance per leg (NOTE 2)	R _{θJC}	2.0		°C/W
Operating junction and storage temperature range	T _J , T _{STG}	-40 to +125		°C

NOTES:

- (1) Pulse test: 300μs pulse width, 1% duty cycle
- (2) Thermal resistance from junction to case per leg
- (3) 2.0μs pulse width, f=1.0 KHz

NOTICE: Advanced product information is subject to change without notice

REV.11/22/96

RATINGS AND CHARACTERISTIC CURVES SBL2030CT AND SBL2040CT

FIG. 1 - FORWARD CURRENT DERATING CURVE

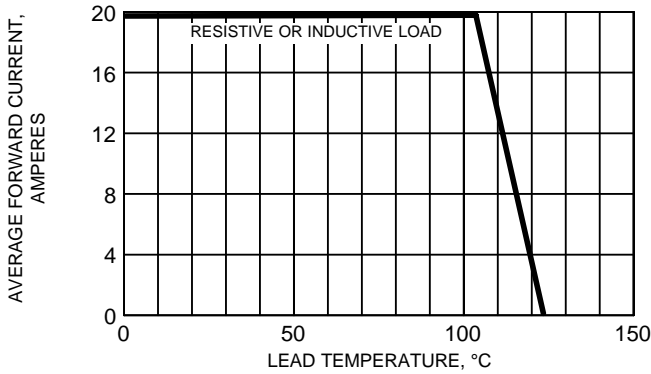

FIG. 2 - MAXIMUM NON-REPETITIVE PEAK FORWARD SURGE CURRENT PER LEG

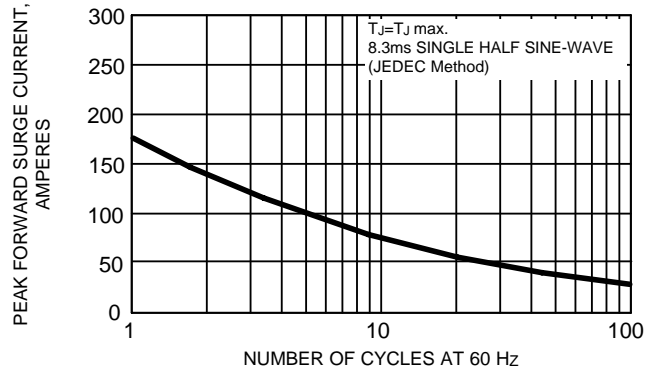

FIG. 3 - TYPICAL INSTANTANEOUS FORWARD CHARACTERISTICS PER LEG

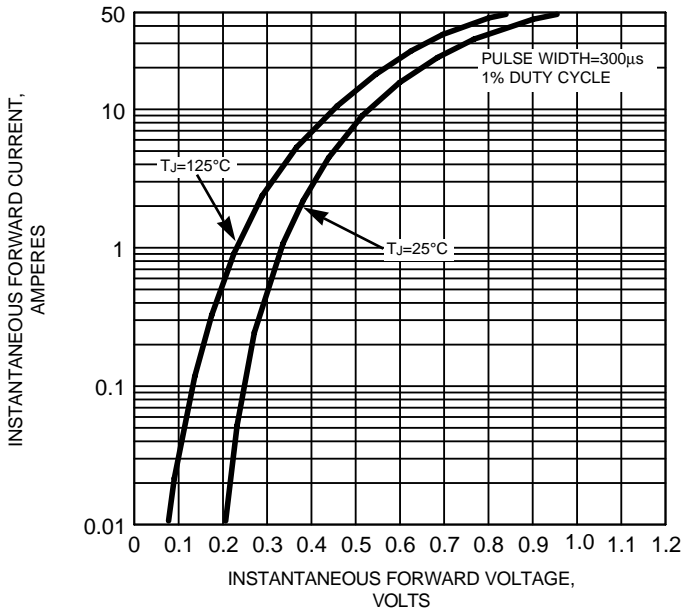

FIG. 4 - TYPICAL REVERSE CHARACTERISTICS PER LEG

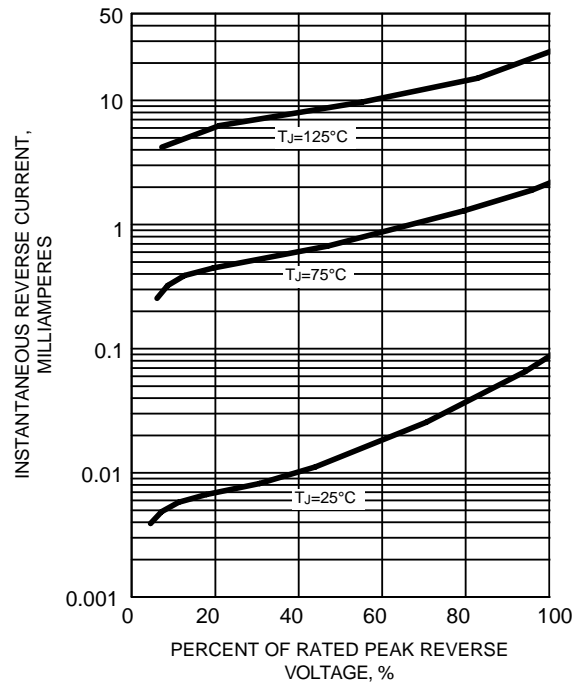

FIG. 5 - TYPICAL JUNCTION CAPACITANCE PER LEG

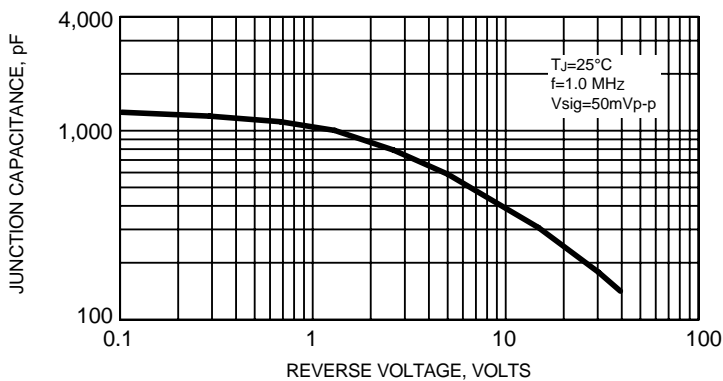

FIG. 6 - TYPICAL TRANSIENT THERMAL IMPEDANCE PER LEG

