



## High-Speed, 6A Single MOSFET Drivers

### General Description

The MAX4420, MAX4429 and MXT429 are single-output MOSFET drivers designed to translate TTL/CMOS inputs to high-voltage/high-current outputs. The low 1.5Ω output impedance and 6A peak current output allow them to rapidly switch high-capacitance power MOSFETs, improving efficiency.

A 40ns delay time and a 25ns rise or fall time (while driving 2500pF to 18V) minimize power losses during MOSFET switching transitions.

The MAX4420/MAX4429/MXT429 interface easily with either CMOS or bipolar switch-mode controllers because their logic inputs draw under 10μA. The outputs swing to within 25mV of GND or the power-supply rail, which can be 4.5V to 18V for the MAX4420/MAX4429, and 7V to 18V for the MXT429.

Power-supply quiescent current is typically 45μA and 450μA for logic input low and high, respectively. The MAX4420 has a non inverting output. The MAX4429 and MXT429 have inverting outputs.

For dual drivers, refer to the MAX626/MAX627/MAX628 and MAX4426/MAX4427/MAX4428 data sheets.

### Applications

- Switching Power Supplies
- DC-DC Converters
- Motor Controllers
- Pin-Diode Drivers

### Pin Configurations

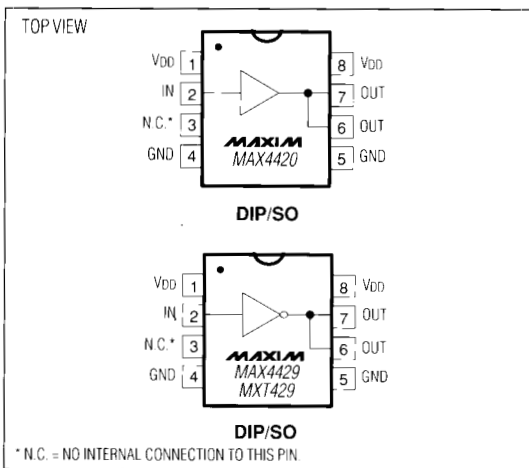

### Features

- ◆ TTL/CMOS Compatible ( $I_{IN} \leq 10\mu A$ )
- ◆ 4.5V to 18V Supply Range (MAX4420/MAX4429)
- ◆ 1.5Ω Output Resistance
- ◆ 6A Peak Output Current
- ◆ 40ns Delay Time
- ◆ 25ns Rise and Fall Times (2500pF Load)
- ◆ Output Swings to within 25mV of  $V_{DD}$  and GND

### Ordering Information

PART	TEMP. RANGE	PIN-PACKAGE
MAX4420CPA	0°C to +70°C	8 Plastic DIP
MAX4420CSA	0°C to +70°C	8 SO
MAX4420C/D	0°C to +70°C	Dice*
MAX4420EPA	-40°C to +85°C	8 Plastic DIP
MAX4420ESA	-40°C to +85°C	8 SO
MAX4420MJA	-55°C to +125°C	8 CERDIP**
MAX4429CPA	0°C to +70°C	8 Plastic DIP
MAX4429CSA	0°C to +70°C	8 SO
MAX4429C/D	0°C to +70°C	Dice*
MAX4429EPA	-40°C to +85°C	8 Plastic DIP
MAX4429ESA	-40°C to +85°C	8 SO
MAX4429MJA	-55°C to +125°C	8 CERDIP**

Ordering information continued on last page.

\* Dice are specified at  $T_A = +25^\circ C$ .

\*\*Contact factory for availability and processing to MIL-STD-883 and DESC-SMD.

### Typical Operating Circuit

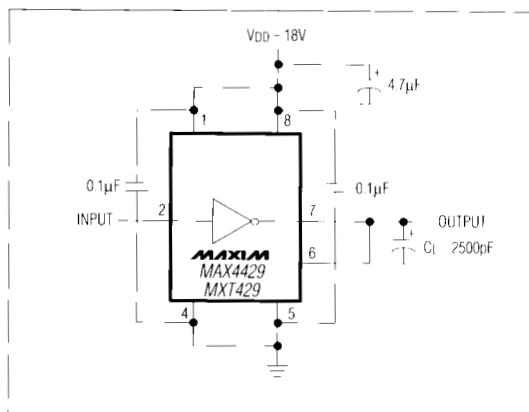

MAX4420/MAX4429/MXT429

## High-Speed, 6A Single MOSFET Drivers

### ABSOLUTE MAXIMUM RATINGS

Supply Voltage $V_{DD}$ to GND	+20V	Operating Temperature Ranges:	
Input Voltage $V_{IN}$	-0.3V to ( $V_{DD}$ + 0.3V)	MAX442_C__, MXT429C__	0°C to +70°C
Continuous Power Dissipation ( $T_A = +70^\circ\text{C}$ )		MAX442_E__, MXT429E__	-40°C to +85°C
Plastic DIP (derate 9.09mW/°C above +70°C)	727mW	MAX442_MJA, MXT429MJA	-55°C to +125°C
SO (derate 5.88mW/°C above +70°C)	471mW	Storage Temperature Range	-65°C to +160°C
CERDIP (derate 8.00mW/°C above +70°C)	640mW	Lead Temperature (soldering, 10sec)	+300°C

Stresses beyond those listed under "Absolute Maximum Ratings" may cause permanent damage to the device. These are stress ratings only, and functional operation of the device at these or any other conditions beyond those indicated in the operational sections of the specifications is not implied. Exposure to absolute maximum rating conditions for extended periods may affect device reliability.

### ELECTRICAL CHARACTERISTICS

(MAX4420/MAX4429  $V_{DD} = +4.5\text{V}$  to +18V, MXT429  $V_{DD} = +7\text{V}$  to +18V,  $T_A = T_{MIN}$  to  $T_{MAX}$ , unless otherwise noted.)

PARAMETER	SYMBOL	CONDITIONS		MAX4420/MAX4429			MXT429			UNITS
				MIN	TYP	MAX	MIN	TYP	MAX	
Operating Range	$V_{DD}$			4.5		18	7		18	V
Power Supply Current	$I_{DD}$	$V_{IN} = 3\text{V}$	$T_A = +25^\circ\text{C}$	0.45		1.5	0.45		5.0	mA
			$T_A = T_{MIN}$ to $T_{MAX}$			3.0		12.0		
		$V_{IN} = 0\text{V}$	$T_A = +25^\circ\text{C}$	0.045		0.150	0.045		0.5	
			$T_A = T_{MIN}$ to $T_{MAX}$			0.400		1.0		
Logic 1 Input Voltage	$V_{IH}$			2.4			2.4		V	
Logic 0 Input Voltage	$V_{IL}$					0.8		0.8	V	
IN Leakage Current	$I_{IN}$	$V_{IN} = 0\text{V}$ to $V_{DD}$				$\pm 10$		$\pm 10$	$\mu\text{A}$	
Output High Voltage	$V_{OH}$	No load		$V_{DD} - 25$			$V_{DD} - 25$			mV
Output Low Voltage	$V_{OL}$	No load		25			25			mV
Peak Output Current	$I_{OUT}$	$V_{DD} = 18\text{V}$	$T_A = +25^\circ\text{C}$	6		6		6		A
Output Resistance	$R_{OUT}$	$V_{DD} = 18\text{V}$ , $I_{OUT} = 10\text{mA}$ , $V_{IN} = 0.8\text{V}$ or $2.4\text{V}$	$T_A = +25^\circ\text{C}$	1.5	2.5	1.5	2.5			$\Omega$
			$T_A = T_{MIN}$ to $T_{MAX}$			5.0		5.0		
Rise Time (Note 1)	$t_R$	Figure 1	$T_A = +25^\circ\text{C}$	25	30	25	35			ns
			$T_A = T_{MIN}$ to $T_{MAX}$			60		70		
Fall Time (Note 1)	$t_F$	Figure 1	$T_A = +25^\circ\text{C}$	25	30	25	35			ns
			$T_A = T_{MIN}$ to $T_{MAX}$			60		70		
Delay Time (Note 1)	$t_{D1}$	Figure 1	$T_A = +25^\circ\text{C}$	35	60	35	75			ns
			$T_A = T_{MIN}$ to $T_{MAX}$			100		100		
	$t_{D2}$	Figure 1	$T_A = +25^\circ\text{C}$	40	60	40	75			
			$T_A = T_{MIN}$ to $T_{MAX}$			100		120		

**Note 1:** Switching times guaranteed by design, not tested. See Figure 1 for timing measurement circuit,  $V_{DD} = 18\text{V}$ .

# High-Speed, 6A Single MOSFET Drivers

## Typical Operating Characteristics

MAX4420/MAX4429/MXT429

**MAX4429 SWITCHING SPEED (INPUT HIGH TO LOW)**

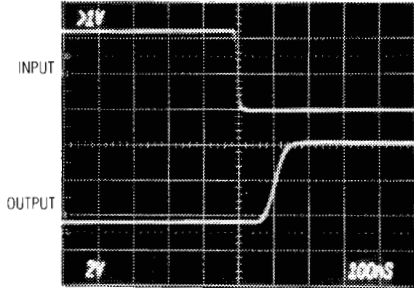

$V_{DD} = 4.5V$ ,  $C_L = 2500pF$ , TIME = 100ns/div,  
 $V_{IN} = 5V$  TO  $0V$ ,  
 $T_A = +25^\circ C$

**MAX4429 SWITCHING SPEED (INPUT LOW TO HIGH)**

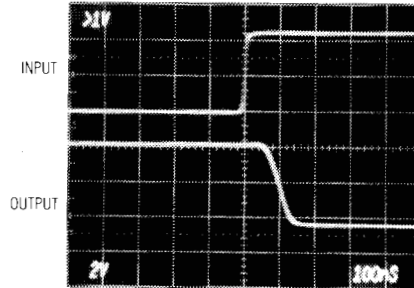

$V_{DD} = 4.5V$ ,  $C_L = 2500pF$ , TIME = 100ns/div,  
 $V_{IN} = 0V$  TO  $5V$ ,  
 $T_A = +25^\circ C$

**MAX4429 SWITCHING SPEED (INPUT HIGH TO LOW)**



$V_{DD} = 18V$ ,  $C_L = 2500pF$ , TIME = 100ns/div,  
 $V_{IN} = 5V$  TO  $0V$ ,  
 $T_A = +25^\circ C$

**MAX4429 SWITCHING SPEED (INPUT LOW TO HIGH)**

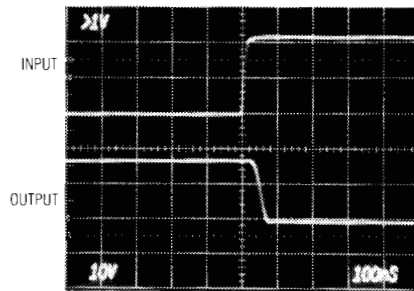

$V_{DD} = 18V$ ,  $C_L = 2500pF$ , TIME = 100ns/div,  
 $V_{IN} = 0V$  TO  $5V$ ,  
 $T_A = +25^\circ C$

**FALL TIME vs. POSITIVE SUPPLY VOLTAGE**



**RISE TIME vs. POSITIVE SUPPLY VOLTAGE**

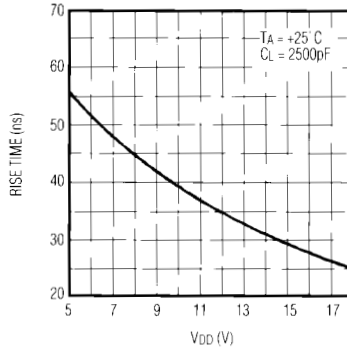

**RISE AND FALL TIMES vs. TEMPERATURE**

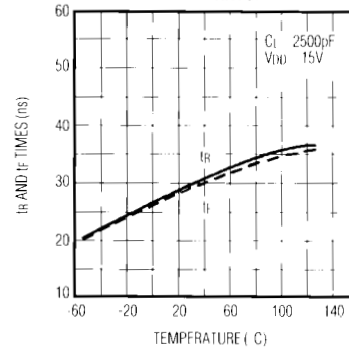

# High-Speed, 6A Single MOSFET Drivers

## Typical Operating Characteristics (continued)

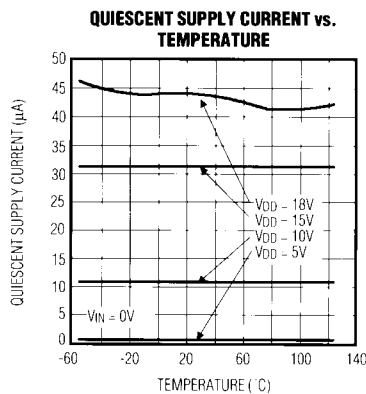
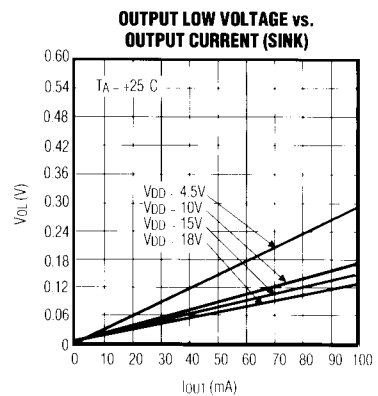
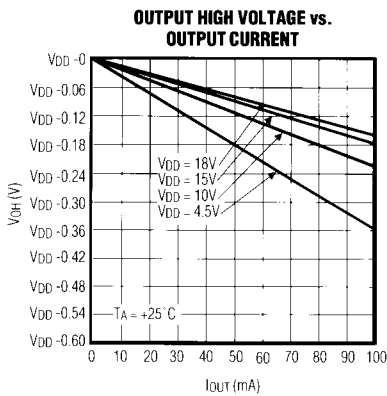
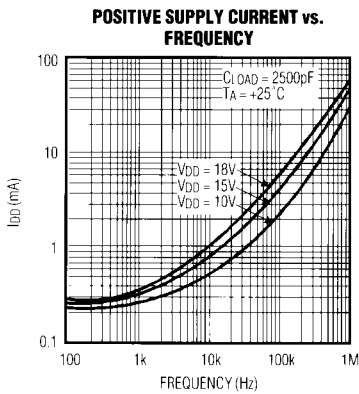
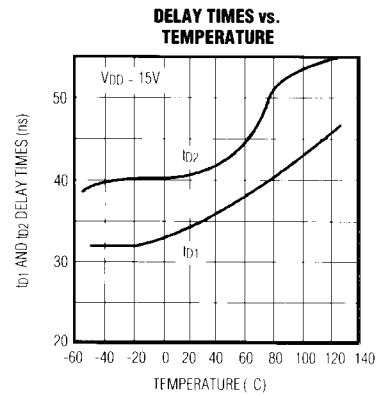
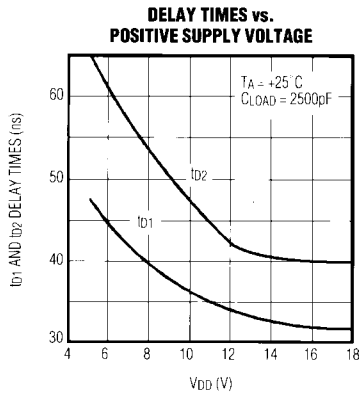
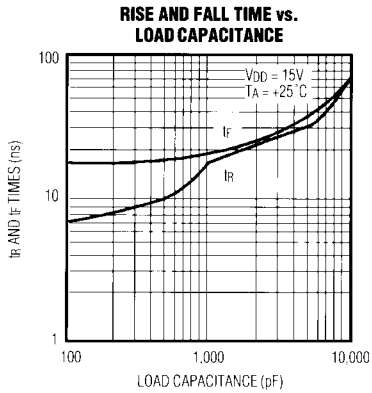

# High-Speed, 6A Single MOSFET Drivers

**MAX4420/MAX4429/MXT429**

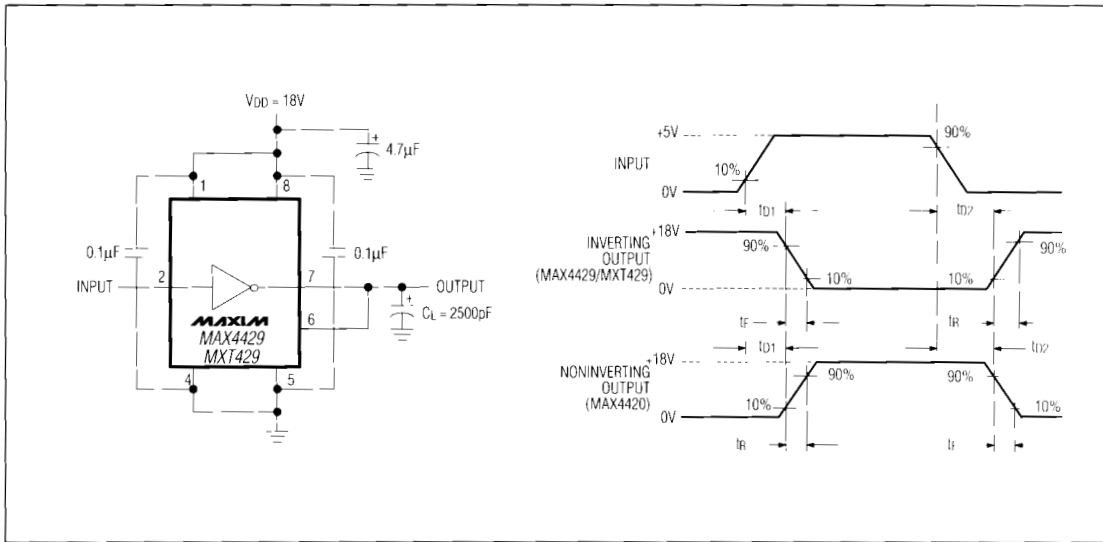

Figure 1. Switching-Time Measurement Circuit

## Applications Information

The MAX4420/MAX4429/MXT429 have easy-to-drive inputs. However, the input must not be allowed to stay between  $V_{IH}$  and  $V_{IL}$  for more than 500ns. The power supply ( $V_{DD}$ ) inputs must always be tied together, as should the outputs (OUT).

Supply bypassing and grounding are extremely important, as the peak supply and output currents can be greater than 6A. Ground drops are a form of negative feedback with inverters, and therefore will degrade the delay and transition time. Ringing may also be a problem with large  $\Delta V/\Delta t$  and/or large AC currents.

Suggested bypass capacitors are a 4.7µF (low ESR) capacitor in parallel with 0.1µF ceramic capacitors, mounted as close as possible to the device. Use a ground plane if possible, or separate ground returns for inputs and outputs. Ringing can be minimized with a 5Ω resistor in series with the output, but this will degrade output transition time.

### Power Dissipation

Power dissipation of the MAX4420/MAX4429/MXT429 consists of:

- 1) input inverter losses
- 2) crowbar current through the output devices
- 3) output current (either capacitive or resistive).

The sum of these must be kept below the maximum power-dissipation limit.

The DC input inverter losses are typically 45µA when the input is low and 450µA when the input is high.

The crowbar current through an output device making a transition is approximately 100mA for a few nanoseconds. This is a small portion of the total supply current, except for high switching frequencies or a small load capacitance (100pF).

The MAX4420/MAX4429/MXT429 power dissipation when driving a ground referenced resistive load is:

$$P = D \times R_{ON(max)} \times I_{LOAD}^2$$

where  $D$  is the percentage of time the MAX4420/MAX4429/MXT429 output pulls high,  $R_{ON(max)}$  is the maximum on resistance of the device with the output high, and  $I_{LOAD}$  is the load current of the MAX4420/MAX4429/MXT429.

For capacitive loads, the power dissipation is:

$$P = C_{LOAD} \times V_{DD}^2 \times \text{FREQ}$$

where  $C_{LOAD}$  is the capacitive load,  $V_{DD}$  is the MAX4420/MAX4429/MXT429 supply voltage, and  $\text{FREQ}$  is the toggle frequency.

## High-Speed, 6A Single MOSFET Drivers

### Ordering Information (continued)

PART	TEMP. RANGE	PIN-PACKAGE
MXT429CPA	0°C to +70°C	8 Plastic DIP
MXT429CSA	0°C to +70°C	8 SO
MXT429C/D	0°C to +70°C	Dice*
MXT429EPA	-40°C to +85°C	8 Plastic DIP
MXT429ESA	-40°C to +85°C	8 SO
MXT429MJA	-55°C to +125°C	8 CERDIP**

\* Dice are specified at  $T_A = +25^\circ\text{C}$ .

\*\* Contact factory for availability and processing to MIL-STD-883 and DESC-SMD.

### Chip Topography

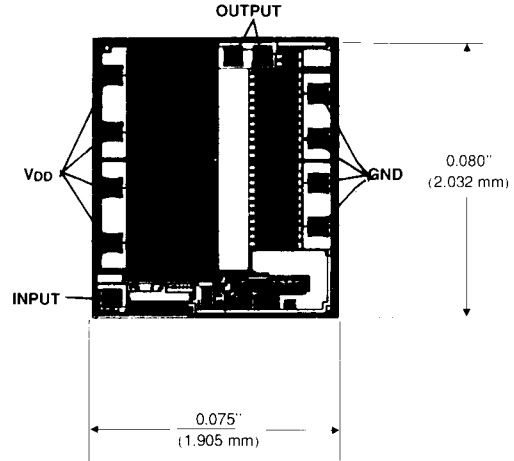

TRANSISTOR COUNT: 16;  
SUBSTRATE CONNECTED TO V<sub>DD</sub>.

Maxim cannot assume responsibility for use of any circuitry other than circuitry entirely embodied in a Maxim product. No circuit patent licenses are implied. Maxim reserves the right to change the circuitry and specifications without notice at any time.

6 Maxim Integrated Products, 120 San Gabriel Drive, Sunnyvale, CA 94086 (408) 737-7600

© 1992 Maxim Integrated Products

Printed USA

**MAXIM** is a registered trademark of Maxim Integrated Products.