



LOW CURRENT LED LAMPS

LTL-4221NLC/307ELC LOW CURRENT HI.EFF.RED

LTL-4231NLC/307GLC LOW CURRENT GREEN

LTL-4251NLC/307YLC LOW CURRENT YELLOW

FEATURES

- LOW POWER CONSUMPTION
- HIGH EFFICIENCY
- CMOS/MOS COMPATIBLE
- TTL COMPATIBLE
- WIDE VIEWING ANGLE

DESCRIPTION

These tinted diffused LED lamps were designed and optimized specifically for low DC current operation. Luminous intensity and forward voltage are tested at 2 mA to assure consistent brightness at TTL output current levels.

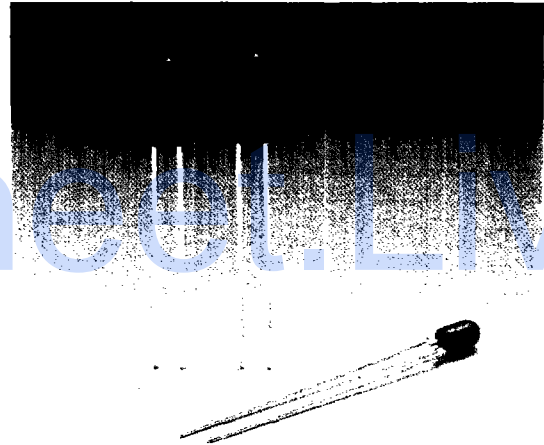

PACKAGE DIMENSIONS

LTL-42 x 1 NLC Series

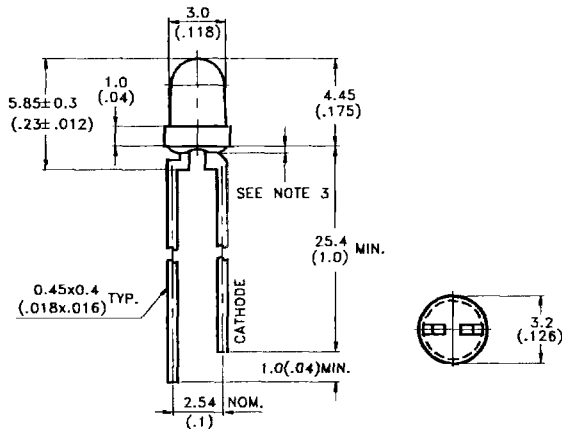

LTL-307 x LC Series

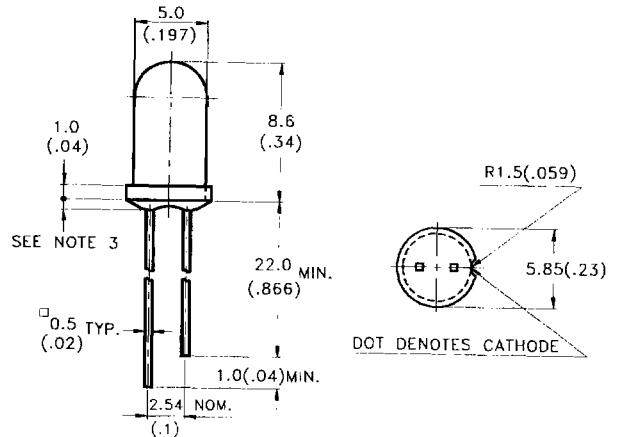

NOTES:

1. All dimensions are in millimeters (inches).
2. Tolerance is $\pm 0.25\text{mm}$ (.010") unless otherwise noted.
3. Protruded resin under flange is 1.0mm (.04") max.
4. Lead spacing is measured where the leads emerge from the package.

DEVICES

PART NO. LTL—	LENS		SOURCE COLOR
	COLOR	DIFFUSION	
4221NLC	Red	Diffused	Hi. Eff. Red
4231NLC	Green	Diffused	Green
4251NLC	Yellow	Diffused	Yellow

PART NO. LTL—	LENS		SOURCE COLOR
	COLOR	DIFFUSION	
307ELC	Red	Diffused	Hi. Eff. Red
307GLC	Green	Diffused	Green
307YLC	Yellow	Diffused	Yellow

ABSOLUTE MAXIMUM RATINGS AT $T_A = 25^\circ\text{C}$

PARAMETER	MAXIMUM RATINGS		UNIT
	Red Green Yellow		
Power Dissipation $T_{amb} \leq 90^\circ\text{C}$	20 20 20		mW
Forward Current	7		mA
Forward Surge Current (10 μ sec Pulse)	500		mA
Reverse Voltage	5		V
Operating Temperature Range	-55 $^\circ\text{C}$ to +100 $^\circ\text{C}$		
Storage Temperature Range	-55 $^\circ\text{C}$ to +100 $^\circ\text{C}$		
Lead Soldering Temperature (1.6mm (0.063in) From Body)	260 $^\circ\text{C}$ for 5 Seconds		

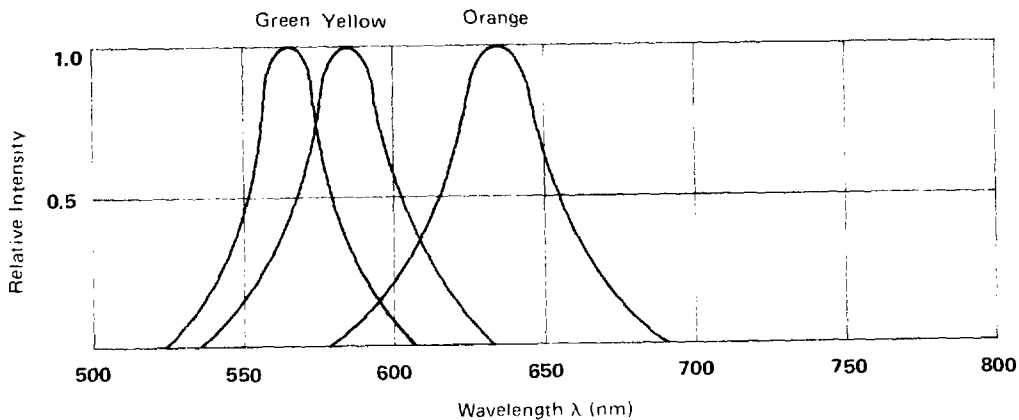

FIG. 1 RELATIVE INTENSITY VS. WAVELENGTH

LED
LAMPS

ELECTRICAL/OPTICAL CHARACTERISTICS AND CURVES AT $T_A=25^\circ\text{C}$

PARAMETER	SYMBOL	PART NO. LTL-	MIN.	TYP.	MAX.	UNIT	TEST CONDITION
Luminous Intensity	I_v	4221NLC 4231NLC 4251NLC	0.7 0.4 0.4	2.5 1.1 1.1		mcd	$I_f = 2\text{ mA}$ Note 1
Viewing Angle	$2\theta^{1/2}$	4221NLC 4231NLC 4251NLC		60		deg	Note 2 (FIG.6)
Peak Emission Wavelength	λ PEAK	4221NLC 4231NLC 4251NLC		635 565 585		nm	Measurement @ Peak (FIG.1)
Dominant Wavelength	λ_d	4221NLC 4231NLC 4251NLC		621 569 588		nm	Note 3
Spectral Line Half Width	$\Delta\lambda$	4221NLC 4231NLC 4251NLC		40 30 35		nm	
Forward Voltage	V_f	4221NLC 4231NLC 4251NLC		1.7 1.9 1.8	2.2 2.2 2.7	V	$I_f = 2\text{ mA}$
Reverse Current	I_r	4221NLC 4231NLC 4251NLC			10 10 10	$\mu\text{ A}$	$V_R = 5\text{ V}$

NOTE : 1. Luminous intensity is measured with a light sensor and filter combination that approximates the CIE eye-response curve.

2. $\theta^{1/2}$ is the off-axis angle at which the luminous intensity is half the axial luminous intensity.

3. The dominant wavelength, λ_d is derived from the CIE chromaticity diagram and represents the single wavelength which defines the color of the device.

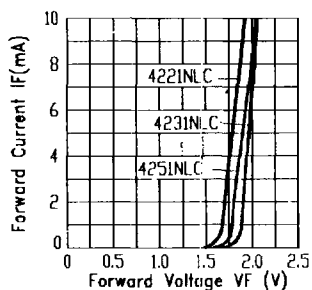

Fig.2 FORWARD CURRENT VS. FORWARD VOLTAGE

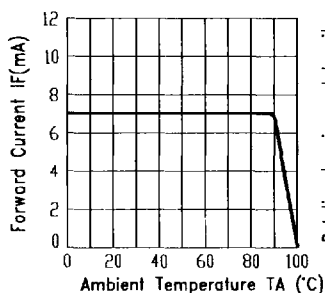

Fig.3 FORWARD CURRENT DERATING CURVE

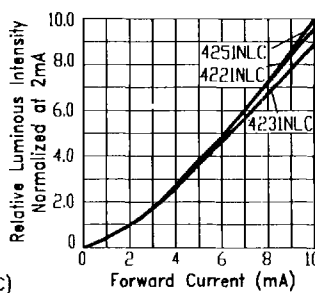

Fig.4 RELATIVE LUMINOUS INTENSITY VS. FORWARD CURRENT

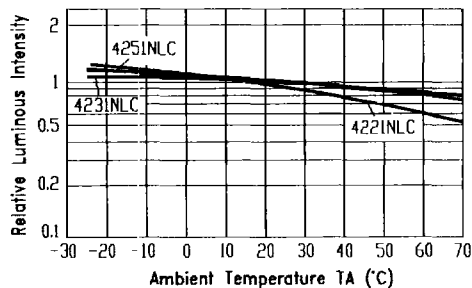

Fig.5 LUMINOUS INTENSITY VS. AMBIENT TEMPERATURE

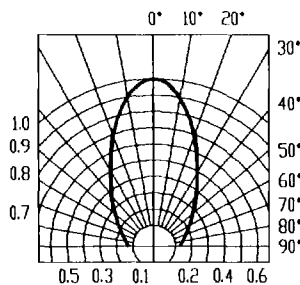

Fig.6 SPATIAL DISTRIBUTION

ELECTRICAL/OPTICAL CHARACTERISTICS AND CURVES AT $T_A=25^\circ\text{C}$

PARAMETER	SYMBOL	PART NO. LTL-	MIN.	TYP.	MAX.	UNIT	TEST CONDITION
Luminous Intensity	I_v	307ELC 307GLC 307YLC	1.1 1.1 1.1	3.7 3.7 3.7		mcd	$I_f = 2\text{ mA}$ Note 1
Viewing Angle	$2\theta_{1/2}$	307ELC 307GLC 307YLC		50		deg	Note 2 (FIG.11)
Peak Emission Wavelength	λ_{PEAK}	307ELC 307GLC 307YLC		635 565 585		nm	Measurement @ Peak (FIG.1)
Dominant Wavelength	λ_d	307ELC 307GLC 307YLC		621 569 588		nm	Note 3
Spectral Line Half Width	$\Delta\lambda$	307ELC 307GLC 307YLC		40 30 35		nm	
Forward Voltage	V_f	307ELC 307GLC 307YLC		1.7 1.9 1.8	2.2 2.2 2.7	V	$I_f = 2\text{ mA}$
Reverse Current	I_r	307ELC 307GLC 307YLC			10 10 10	μA	$V_R = 5\text{ V}$

NOTE : 1. Luminous intensity is measured with a light sensor and filter combination that approximates the CIE eye-response curve.

2. $\theta_{1/2}$ is the off-axis angle at which the luminous intensity is half the axial luminous intensity.

3. The dominant wavelength, λ_d is derived from the CIE chromaticity diagram and represents the single wavelength which defines the color of the device.

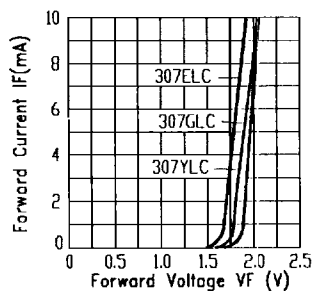

Fig.7 FORWARD CURRENT VS. FORWARD VOLTAGE

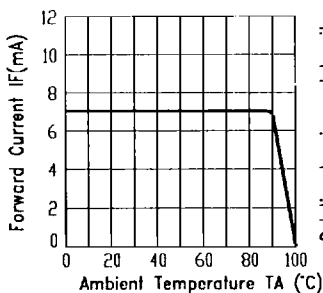

Fig.8 FORWARD CURRENT DERATING CURVE

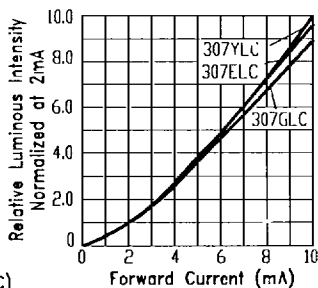

Fig.9 RELATIVE LUMINOUS INTENSITY VS. FORWARD CURRENT

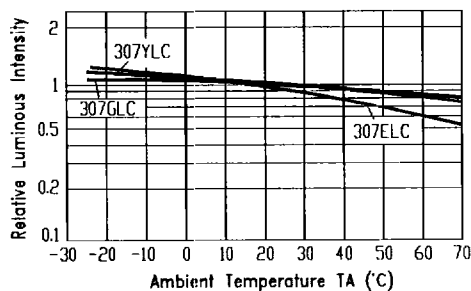

Fig.10 LUMINOUS INTENSITY VS. AMBIENT TEMPERATURE

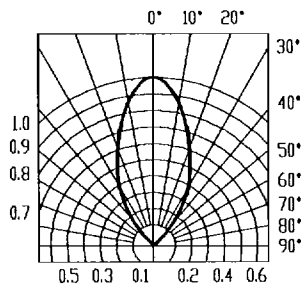

Fig.11 SPATIAL DISTRIBUTION

LED
LAMPS