

### Key features

- up to 17 watts
- fusible types
- vertical or axial
- non flammable
- special solvent resistance
- high withstand voltage proof
- customer specials welcomed



### Power Resistors

### type SBC series

This range of power wirewound resistors are wound on continuous glass fibre elements, or solid ceramic, dependant on value. The element is housed in a ceramic case and sealed with an inorganic silica filler. Their construction gives a resistor with high insulation resistance and low surface temperature, capable of withstanding high overload currents.

### Specification

#### Electrical

Resistance Values:	E24 Series 5% , E12 Series 10% (see tables for values)
Resistance Tolerance:	±5%, ±10%
Maximum Continuous Voltage:	$\sqrt{\text{Power} \times \text{Resistance}}$
Load Life:	±3% 1000 hours at 70°C
Power Rating:	See Tables
Temperature Coefficient:	± 200ppm/°C (<18R 400 ppm/°C)
Dielectric Strength:	2000V RMS
Insulation Resistance:	>10 x 10 <sup>4</sup> M
Temperature Range:	0°C ~ +70°C

### Dimensions

#### SBC Type (Plain Ceramic) [power @ 20°C]

Type	Power	Dimensions (mm)			Ohmic Values	
		H	W	L	Min	Max
SBC-2	2W	6.4	6.4	20.0	R20	150R
SBC-4	4W	6.4	6.4	25.0	R30	3K3
SBC-6	6W	6.4	6.4	38.0	1R0	8K2
SBC-8	8W	9.0	9.0	38.0	1R0	8K2
SBC-11	10W	9.0	9.0	50.0	3R3	12K
SBC-15	15W	9.0	9.0	75.0	4R7	18K

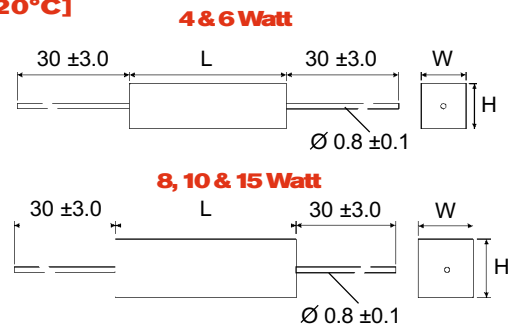

#### SBCH Type (Fluted Ceramic) [power @ 20°C]

Type	Power	Dimensions (mm)			Ohmic Values	
		H	W	L	Min	Max
SBCH-4	4W	8.0	7.0	20.0	R20	10K
SBCH-5	5W	8.0	7.0	25.0	R30	10K
SBCH-6	7W	8.0	7.0	38.0	1R0	15K
SBCH-7	7W	10.0	9.0	25.0	R33	15K
SBCH-8	9W	10.0	9.0	38.0	1R0	8K2
SBCH-10	11W	10.0	9.0	50.0	3R3	22K
SBCH-15	17W	10.0	9.0	75.0	4R7	22K

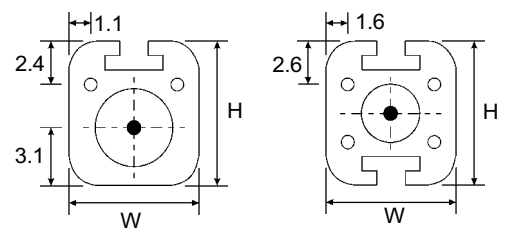

wirewound square ceramic cased

Dimensions (Cont...)

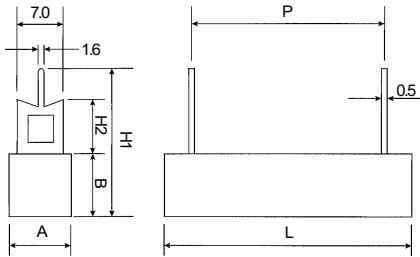

SCPC Type (Radial Plug in) [power @ 20°C]

Type	Power	Dimensions (mm)						Ohmic Values	
		H1	H2	L	A	B	P	Min	Max
SCPC-3	3W	23.0	10.0	22.0	10.0	9.0	10.0	R10	330R
SCPC-5	5W	25.0	10.0	27.0	10.0	9.0	15.0	R10	1K0
SCPC-7	7W	25.0	10.0	35.0	10.0	9.0	22.5	R10	2K7
SCPC-10	10W	25.0	10.0	50.0	10.0	9.0	37.0	R20	8K2
SCPC-20	20W	43.0	25.0	63.0	13.0	12.0	49.0	R30	15K

SBCLF Type (External Fuse) [power @ 20°C]

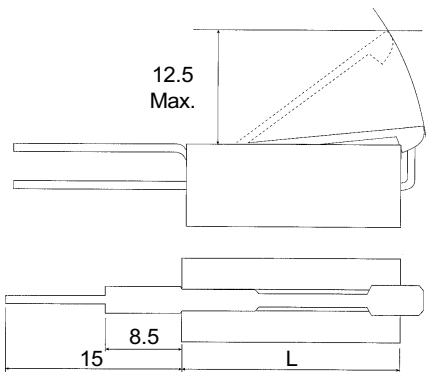

Type	Power	Body Length	Ohmic Values	
			Min	Max
SBCLF-4	4W	25.0	2R2	2K2
SBCLF-5	5W	38.0	2R2	5K6
SBCLF-7	7W	50.0	3R3	8K2
SBCLF-10	10W	75.0	4R7	12K

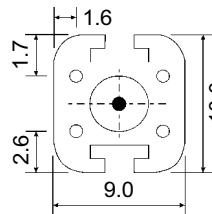

SBCV Type (Vertical Mount) [power @ 20°C]

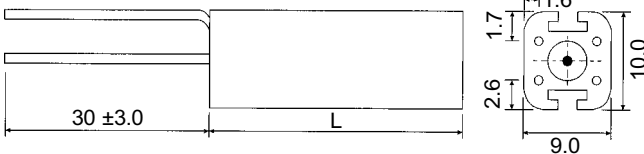

Type	Power	Body Length	Ohmic Values	
			Min	Max
SBCV-6	6W	25.0	2R2	15K
SBCV-8	8W	38.0	2R2	5K6
SBCV-10	10W	50.0	3R3	22K
SBCV-15	15W	75.0	4R7	22K

SPW Type (Faston Terminals) [power @ 20°C]

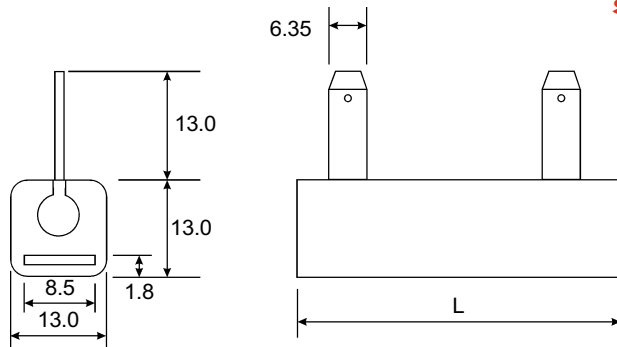

Type	Power	Body Length	Ohmic Values	
			Min	Max
SPW-10	10W	38.0	2R2	8K2
SPW-15	15W	50.0	3R3	10K
SPW-20	20W	75.0	4R7	15K
SPW-30	30W	100	6R8	18K
SPW-35	35W	120	8R2	22K

How To Order

Common Part	Rated Power	Resistor Value	Tolerance
SBC - Axial Type Plain Ceramic SBCH - Axial Fluted SBCHE - Axial, One Long Lead SBCV - Vertical Type SBCLF - Fused Type SCPC - Radial Type SPW - Lug Terminal	See Relevant Table	0.1W (100 milli ohms) R10 1.0W (1000 milli ohms) 1R0 1K0 (1000 ohms) 1K0	J - 5% K - 10%

N.B. All resistors are supplied with Arkclone proof seal  
N.B. Vertical Mounting brackets are available - please enquire

Power Resistors

type SBC series

These resistors are ideally suited to a variety of applications within industrial and commercial environments, where performance and reliability are of prime importance. Applications include fan force ovens, cooker hoods, power supplies and triac based speed controls. This range was previously sold as the Holsworthy SC Series. The vertical versions require support accessories, please enquire.

Please Request Full Data Sheet F0423