

Surface Mount Transient Voltage Suppressor

Absolute Maximum Ratings T_A = 25°C unless otherwise noted

Symbol	Parameter	Value	Units
P _{PPM}	Peak Power Dissipation at T _A = 25°C, T _P = 1ms (Note 1)	Min. 400	Watts
I _{FSM}	Peak Forward Surge Current 8.3ms Single Half Sine-Wave Superimposed on Rated Load (JEDEC method) (Note 2)	40	A
T _J , T _{STG}	Operating and Storage Temperature Range	-55 to +150	°C

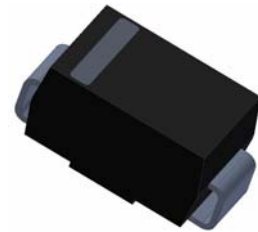

SMA (DO-214AC)

Notes:

1. Non-repetitive current pulse, per Fig. 3 and derated above T_A = 25°C per Fig. 2. Rating is 300W above 78V.
2. Mounted on 0.2 x 0.2" (5.0 x 5.0mm) copper pads to each terminal.
3. 8.3ms single half sine-wave of equivalent square wave, duty cycle-4 pulse per minutes maximum.

Specification Features:

- For Surface Mounted Application
- Low Profile Package
- Built-in Strain Relief
- Glass Passivated Junction
- Excellent Clamping Capability
- Fast Response Time: Typically Less Than 1.0ps From 0V to BV min.
- High Temperature Soldering: 250°C/10 Seconds at Terminal.
- Plastic Material Used Carries Underwriters Laboratory Flammability Classification 94V-0
- 400W Peak Pulse Power Capability With a 10/1000us Waveform, repetition Rate (Duty Cycle): 0.01% (300W above 78V)
- Pb Free Version and RoHS Compliant
- Band Indicates Cathode

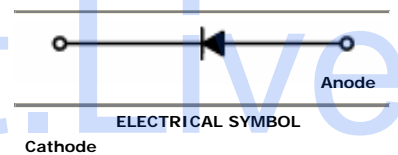

Electrical Characteristics T_A = 25°C unless otherwise noted

Device Type	Device marking		Breakdown voltage V _(BR) @ I _r (Volts) Note 1		I _r (mA)	Maximum reverse current I _D @ V _{WM} (uA) Note 2	Stand-off voltage V _{WM} (Volts)	Maximum clamping voltage V _C @ I _{VPPM} (Volts)	Maximum peak pulse surge current I _{PPM} Note 3
	UNI	BI	Min.	Max.					
TCSMAJ5.0	AD	WD	6.40	7.30	10	800	5.0	9.6	32.0
TCSMAJ5.0A	AE	WE	6.40	7.00	10	800	5.0	9.2	34.0
TCSMAJ6.0	AF	WF	6.67	8.15	10	800	6.0	11.4	27.6
TCSMAJ6.0A	AG	WG	6.67	7.37	10	800	6.0	10.3	30.5
TCSMAJ6.5	AH	WH	7.22	8.82	10	500	6.5	12.3	25.6
TCSMAJ6.5A	AK	WK	7.22	7.97	10	500	6.5	11.2	28.0
TCSMAJ7.0	AL	WL	7.78	9.51	10	200	7.0	13.3	23.6
TCSMAJ7.0A	AM	WM	7.78	8.60	10	200	7.0	12.0	26.0
TCSMAJ7.5	AN	WN	8.33	10.3	1.0	100	7.5	14.3	22.0
TCSMAJ7.5A	AP	WP	8.33	9.21	1.0	100	7.5	12.9	24.4

Electrical Characteristics $T_A = 25^\circ\text{C}$ unless otherwise noted

Device Type	Device marking		Breakdown voltage $V_{(BR)}$ @ I_r (Volts) Note 1		I_r (mA)	Maximum reverse current I_D @ V_{WM} (uA) Note 2	Stand-off voltage V_{WM} (Volts)	Maximum clamping voltage V_C @ I_{PPM} (Volts)	Maximum peak pulse surge current I_{PPM} Note 3
	UNI	BI	Min.	Max.					
TCSMAJ8.0	AQ	WQ	8.89	10.9	1.0	50.0	8.0	15.0	21.0
TCSMAJ8.0A	AR	WR	8.89	9.83	1.0	50.0	8.0	13.6	23.0
TCSMAJ8.5	AS	WS	9.44	11.5	1.0	10.0	8.5	15.9	19.8
TCSMAJ8.5A	AT	WT	9.44	10.4	1.0	10.0	8.5	14.4	21.8
TCSMAJ9.0	AU	WU	10.0	12.2	1.0	5.0	9.0	16.9	18.6
TCSMAJ9.0A	AV	WV	10.0	11.1	1.0	5.0	9.0	15.4	20.4
TCSMAJ10	AW	WW	11.1	13.6	1.0	5.0	10	18.6	16.7
TCSMAJ10A	AX	WX	11.1	12.3	1.0	5.0	10	17.0	18.5
TCSMAJ11	AY	WY	12.2	14.9	1.0	5.0	11	20.1	15.6
TCSMAJ11A	AZ	WZ	12.2	13.5	1.0	5.0	11	18.2	17.3
TCSMAJ12	BD	XD	13.3	16.3	1.0	5.0	12	22.0	14.3
TCSMAJ12A	BE	XE	13.3	14.7	1.0	5.0	12	19.9	15.8
TCSMAJ13	BF	XF	14.4	17.6	1.0	5.0	13	23.8	13.0
TCSMAJ13A	BG	XG	14.4	15.9	1.0	5.0	13	21.5	14.6
TCSMAJ14	BH	XH	15.6	19.1	1.0	5.0	14	25.8	12.2
TCSMAJ14A	BK	XK	15.6	17.2	1.0	5.0	14	23.2	13.5
TCSMAJ15	BL	XL	16.7	20.4	1.0	5.0	15	26.9	11.7
TCSMAJ15A	BM	XM	16.7	18.5	1.0	5.0	15	24.4	12.9
TCSMAJ16	BN	XN	17.8	21.8	1.0	5.0	16	28.8	10.9
TCSMAJ16A	BP	XP	17.8	19.7	1.0	5.0	16	26.0	12.0
TCSMAJ17	BQ	XQ	18.9	23.1	1.0	5.0	17	30.5	10.3
TCSMAJ17A	BR	XR	18.9	20.9	1.0	5.0	17	27.6	11.4
TCSMAJ18	BS	XS	20.0	24.4	1.0	5.0	18	32.2	9.7
TCSMAJ18A	BT	XT	20.0	22.1	1.0	5.0	18	29.2	10.7
TCSMAJ20	BU	XU	22.2	27.1	1.0	5.0	20	35.8	8.7
TCSMAJ20A	BV	XV	22.2	24.5	1.0	5.0	20	32.4	9.7
TCSMAJ22	BW	XW	24.4	29.8	1.0	5.0	22	39.4	8.0
TCSMAJ22A	BX	XX	24.4	26.9	1.0	5.0	22	35.5	8.8
TCSMAJ24	BY	XY	26.7	32.6	1.0	5.0	24	43.0	7.3
TCSMAJ24A	BZ	XZ	26.7	29.5	1.0	5.0	24	38.9	8.0
TCSMAJ26	CD	YD	28.9	35.3	1.0	5.0	26	46.6	6.7
TCSMAJ26A	CE	YE	28.9	31.9	1.0	5.0	26	42.1	7.4
TCSMAJ28	CF	YF	31.1	38.0	1.0	5.0	28	50.0	6.3
TCSMAJ28A	CG	YG	31.1	34.4	1.0	5.0	28	45.4	6.9
TCSMAJ30	CH	YH	33.3	40.7	1.0	5.0	30	53.5	5.8
TCSMAJ30A	CK	YK	33.3	36.8	1.0	5.0	30	48.4	6.5
TCSMAJ33	CL	YL	36.7	44.9	1.0	5.0	33	59.0	5.3
TCSMAJ33A	CM	YM	36.7	40.6	1.0	5.0	33	53.3	5.9
TCSMAJ36	CN	YN	40.0	48.9	1.0	5.0	36	64.3	4.8
TCSMAJ36A	CP	YP	40.0	44.2	1.0	5.0	36	58.1	5.4
TCSMAJ40	CQ	YQ	44.4	54.3	1.0	5.0	40	71.4	4.4
TCSMAJ40A	CR	YR	44.4	49.1	1.0	5.0	40	64.5	4.8

Electrical Characteristics $T_A = 25^\circ\text{C}$ unless otherwise noted

Device Type	Device marking		Breakdown voltage $V_{(BR)}$ @ I_r (Volts) Note 1		I_r (mA)	Maximum reverse current I_D @ V_{WM} (uA) Note 2	Stand-off voltage V_{WM} (Volts)	Maximum clamping voltage V_C @ I_{VPPM} (Volts)	Maximum peak pulse surge current I_{PPM} Note 3
	UNI	BI	Min.	Max.					
TCSMAJ43	CS	YS	47.8	58.4	1.0	5.0	43	76.7	4.1
TCSMAJ43A	CT	YT	47.8	52.8	1.0	5.0	43	69.4	4.5
TCSMAJ45	CU	YU	50.0	61.1	1.0	5.0	45	80.3	3.9
TCSMAJ45A	CV	YV	50.0	55.3	1.0	5.0	45	72.7	4.3
TCSMAJ48	CW	YW	53.3	65.1	1.0	5.0	48	85.5	3.6
TCSMAJ48A	CX	YX	53.3	58.9	1.0	5.0	48	77.4	4.0
TCSMAJ51	CY	YY	56.7	69.3	1.0	5.0	51	91.1	3.4
TCSMAJ51A	CZ	YZ	56.7	62.7	1.0	5.0	51	82.4	3.8
TCSMAJ54	RD	ZD	60.0	73.3	1.0	5.0	54	96.3	3.2
TCSMAJ54A	RE	ZE	60.0	66.3	1.0	5.0	54	87.1	3.6
TCSMAJ58	RF	ZF	64.4	78.7	1.0	5.0	58	103	3.0
TCSMAJ58A	RG	ZG	64.4	71.2	1.0	5.0	58	93.6	3.3
TCSMAJ60	RH	ZH	66.7	81.5	1.0	5.0	60	107	2.9
TCSMAJ60A	RK	ZK	66.7	73.7	1.0	5.0	60	96.8	3.2
TCSMAJ64	RL	ZL	71.1	86.9	1.0	5.0	64	114	2.7
TCSMAJ64A	RM	ZM	71.1	78.6	1.0	5.0	64	103	3.0
TCSMAJ70	RN	ZN	77.8	95.1	1.0	5.0	70	125	2.5
TCSMAJ70A	RP	ZP	77.8	86.0	1.0	5.0	70	113	2.7
TCSMAJ75	RQ	ZQ	83.3	102	1.0	5.0	75	134	2.3
TCSMAJ75A	RR	ZR	83.3	92.1	1.0	5.0	75	121	2.6
TCSMAJ78	RS	ZS	86.7	106	1.0	5.0	78	139	2.2
TCSMAJ78A	RT	ZT	86.7	95.8	1.0	5.0	78	126	2.5
TCSMAJ85	RU	ZU	94.4	115	1.0	5.0	85	151	2.0
TCSMAJ85A	RV	ZV	94.4	104	1.0	5.0	85	137	2.2
TCSMAJ90	RW	ZW	100	122	1.0	5.0	90	160	1.9
TCSMAJ90A	RX	ZX	100	111	1.0	5.0	90	146	2.1
TCSMAJ100	RY	ZY	111	136	1.0	5.0	100	179	1.7
TCSMAJ100A	RZ	ZZ	111	123	1.0	5.0	100	162	1.9
TCSMAJ110	SD	VD	122	149	1.0	5.0	110	196	1.6
TCSMAJ110A	SE	VE	122	135	1.0	5.0	110	177	1.7
TCSMAJ120	SF	VF	133	163	1.0	5.0	120	214	1.4
TCSMAJ120A	SG	VG	133	147	1.0	5.0	120	193	1.6
TCSMAJ130	SH	VH	144	176	1.0	5.0	130	231	1.3
TCSMAJ130A	SK	VK	144	159	1.0	5.0	130	209	1.5
TCSMAJ150	SL	VL	167	204	1.0	5.0	150	268	1.1
TCSMAJ150A	SM	VM	167	185	1.0	5.0	150	243	1.3
TCSMAJ160	SN	VN	178	218	1.0	5.0	160	287	1.0
TCSMAJ160A	SP	VP	178	197	1.0	5.0	160	259	1.2
TCSMAJ170	SQ	VQ	189	231	1.0	5.0	170	304	1.0
TCSMAJ170A	SR	VR	189	209	1.0	5.0	170	275	1.1

Notes:

1. Pulse test: $t_p \leq 50\text{ms}$
2. For bi-directional types having V_{WM} of 10 Volts and less, the I_D is doubled.
3. Surge current waveform per Fig 3 and derate per Fig 2.
4. For Bidirectional use C or CA suffix for types TCSMAJ5.0 through types TCSMAJ170.
5. Electrical characteristics apply in both directions for bipolar devices.

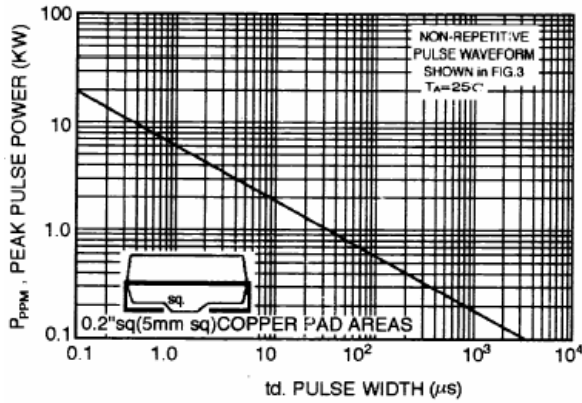
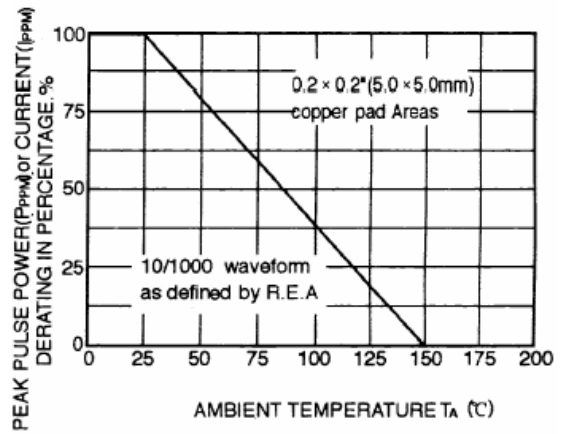
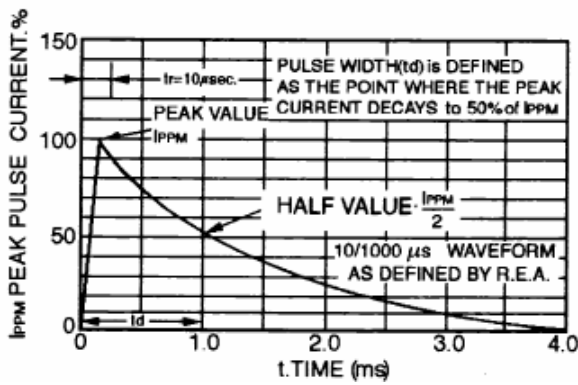
Rating And Characteristic Curves
FIG. 1 – PEAK PULSE POWER RATING CURVE

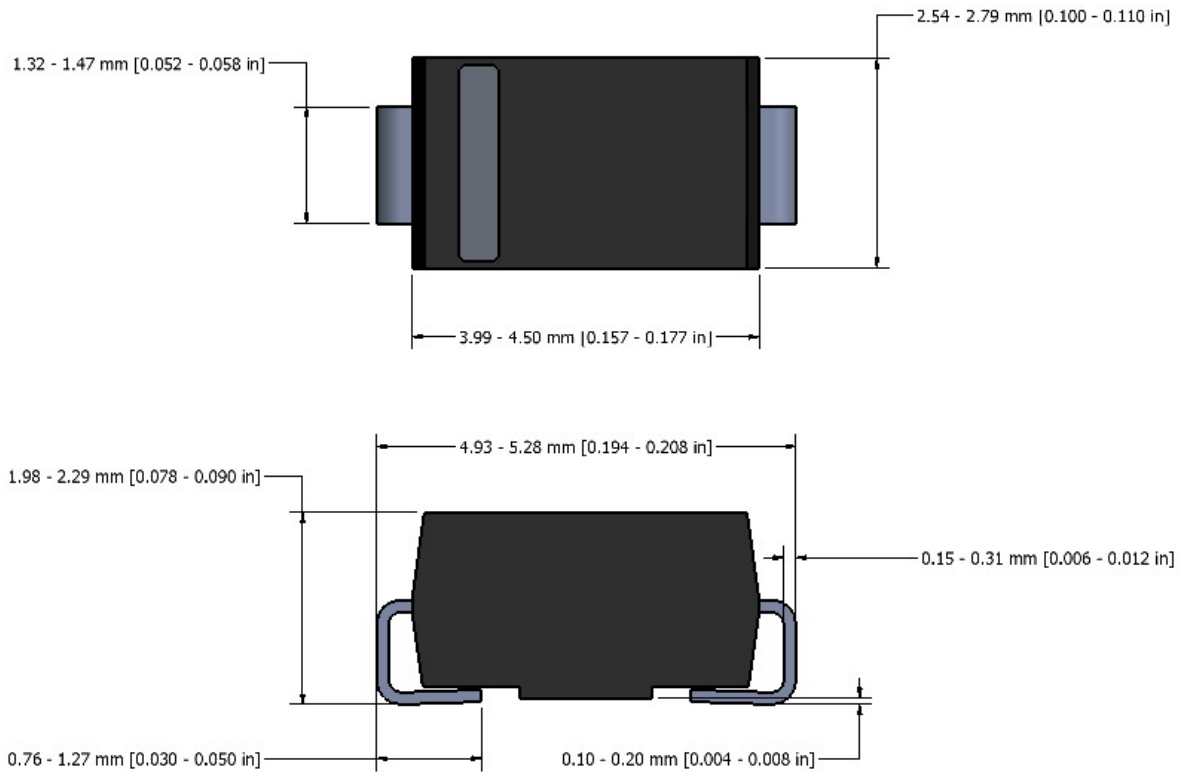
FIG. 2 – PULSE DERATING CURVE

FIG. 3 – PULSE WAVEFORM

SMA (DO-214AC) Package Outline

This datasheet presents technical data of Tak Cheong's TVS Diodes. Complete specifications for the individual devices are provided in the form of datasheets. A comprehensive Selector Guide is included to simplify the task of choosing the best set of components required for a specific application. For additional information, please visit our website <http://www.takcheong.com>.

Although information in this datasheet has been carefully checked, no responsibility for the inaccuracies can be assumed by Tak Cheong. Please consult your nearest Tak Cheong's sales office for further assistance.

Tak Cheong reserves the right to make changes without further notice to any products herein to further improve reliability, function or design, cost and productivity.

TAK CHEONG[®] and  are registered trademarks of Tak Cheong Electronics (Holdings) Co., Ltd.