

LMH6645/46/47

2.7V, 650µA, 55MHz, Rail-to-Rail Input and Output Amplifiers with Shutdown Option

General Description

The LMH™6645 (single) and LMH6646 (dual), rail-to-rail input and output voltage feedback amplifiers, offer high speed (55MHz), and low voltage operation (2.7V) in addition to micro-power shutdown capability (LMH6647, single).

Input common mode voltage range exceeds either supply by 0.3V, enhancing ease of use in multitude of applications where previously only inferior devices could be used. Output voltage range extends to within 20mV of either supply rails, allowing wide dynamic range especially in low voltage applications. Even with low supply current of 650µA/amplifier, output current capability is kept at a respectable ±20mA for driving heavier loads. Important device parameters such as BW, Slew Rate and output current are kept relatively independent of the operating supply voltage by a combination of process enhancements and design architecture.

In portable applications, the LMH6647 provides shutdown capability while keeping the turn-off current to less than 50µA. Both turn-on and turn-off characteristics are well behaved with minimal output fluctuations during transitions. This allows the part to be used in power saving mode, as well as multiplexing applications. Miniature packages (SOT23, MSOP-8, and SO-8) are further means to ease the adoption of these low power high speed devices in applications where board area is at a premium.

Features

($V_S = 2.7V$, $T_A = 25^\circ C$, $R_L = 1k\Omega$ to $V^+/2$, $A_V = +1$. Typical values unless specified).

- -3dB BW 55MHz
- Supply voltage range 2.5V to 12V
- Slew rate 22V/µs
- Supply current 650µA/channel
- Output short circuit current 42mA
- Linear output current ±20mA
- Input common mode voltage 0.3V beyond rails
- Output voltage swing 20mV from rails
- Input voltage noise 17nV/√Hz
- Input current noise 0.75pA/√Hz

Applications

- Active filters
- High speed portable devices
- Multiplexing applications (LMH6647)
- Current sense buffer
- High speed transducer amp

Connection Diagrams

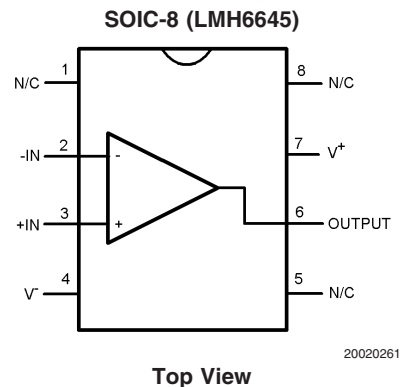
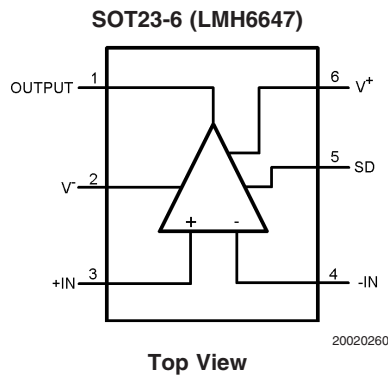
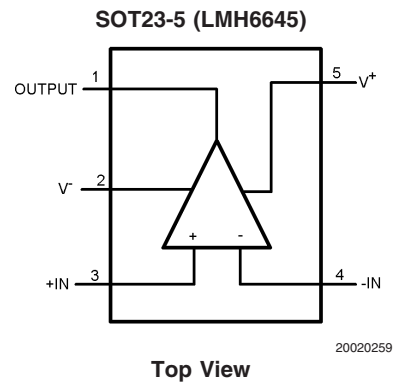

LMH™ is a trademark of National Semiconductor Corporation.

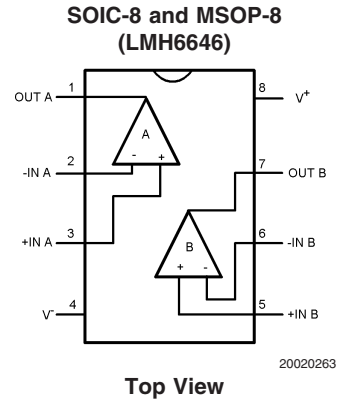
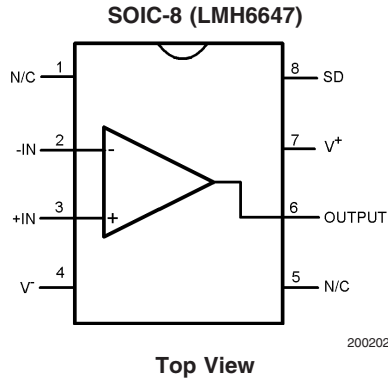

Ordering Information

Package	Part Number	Package Marking	Transport Media	NSC Drawing
5-Pin SOT-23	LMH6645MF	A68A	1k Units Tape and Reel	MF05A
	LMH6645MFX		3k Units Tape and Reel	
6-Pin SOT-23	LMH6647MF	A69A	1k Units Tape and Reel	MF06A
	LMH6647MFX		3k Units Tape and Reel	
SOIC-8	LMH6645MA	LMH6645MA	95 Units Rails	M08A
	LMH6645MAX		2.5k Units Tape and Reel	
	LMH6646MA	LMH6646MA	95 Units Rails	
	LMH6646MAX		2.5k Units Tape and Reel	
	LMH6647MA	LMH6647MA	95 Units Rails	
	LMH6647MAX		2.5k Units Tape and Reel	
MSOP-8	LMH6646MM	A70A	1k Units Tape and Reel	MUA08A
	LMH6646MMX		3.5k Units Tape and Reel	

Absolute Maximum Ratings (Note 1)

If Military/Aerospace specified devices are required, please contact the National Semiconductor Sales Office/Distributors for availability and specifications.

ESD Tolerance	
Human Body	2KV (Note 2)
Machine Model	200V (Note 9)
V _{IN} Differential	±2.5V
Output Short Circuit Duration	(Note 3, 11)
Supply Voltage (V ⁺ - V ⁻)	12.6V
Voltage at Input/Output pins	V ⁺ +0.8V, V ⁻ -0.8V
Storage Temperature Range	-65°C to +150°C
Junction Temperature (Note 4)	+150°C

Soldering Information

Infrared or Convection (20 sec)	235°C
Wave Soldering (10 sec)	260°C

Operating Ratings (Note 1)

Supply Voltage (V ⁺ - V ⁻)	2.5V to 12V
Temperature Range (Note 4)	-40°C to +85°C
Package Thermal Resistance (Note 4) (θ _{JA})	
SOT23-5	265°C/W
SOT23-6	265°C/W
SOIC-8	190°C/W
MSOP-8	235°C/W

2.7V Electrical Characteristics

Unless otherwise specified, all limits guaranteed for at T_J = 25°C, V⁺ = 2.7V, V⁻ = 0V, V_{CM} = V_O = V⁺/2, and R_f = 2kΩ, and R_L = 1kΩ to V⁺/2. **Boldface** limits apply at the temperature extremes.

Symbol	Parameter	Conditions	Min (Note 6)	Typ (Note 5)	Max (Note 6)	Units
BW	-3dB BW	A _V = +1, V _{OUT} = 200mV _{PP} , V _{CM} = 0.7V	40	55		MHz
e _n	Input-Referred Voltage Noise	f = 100kHz		17		nV/√Hz
		f = 1kHz		25		
i _n	Input-Referred Current Noise	f = 100kHz		0.75		pA/√Hz
		f = 1kHz		1.20		
CT Rej.	Cross-Talk Rejection (LMH6646 only)	f = 5MHz, Receiver: R _f = R _g = 510Ω, A _V = +2		47		dB
SR	Slew Rate	A _V = -1, V _O = 2V _{PP} (Note 8, 13)	15	22		V/μs
T _{ON}	Turn-On Time (LMH6647 only)			250		ns
T _{OFF}	Turn-Off Time (LMH6647 only)			560		ns
TH _{SD}	Shutdown Threshold (LMH6647 only)	I _S ≤ 50μA		1.95	2.30	V
I _{SD}	Shutdown Pin Input Current (LMH6647 only)	(Note 7)		-20		μA
V _{OS}	Input Offset Voltage	0V ≤ V _{CM} ≤ 2.7V	-3 -4	±1	3 4	mV
TC V _{OS}	Input Offset Average Drift	(Note 12)		±5		μV/°C
I _B	Input Bias Current	V _{CM} = 2.5V (Note 7)		0.40	2 2.2	μA
		V _{CM} = 0.5V (Note 7)		-0.68	-2 -2.2	
I _{OS}	Input Offset Current	0V ≤ V _{CM} ≤ 2.7V		1	500	nA
R _{IN}	Common Mode Input Resistance			3		MΩ
C _{IN}	Common Mode Input Capacitance			2		pF
CMVR	Input Common-Mode Voltage Range	CMRR ≥ 50dB		-0.5	-0.3 -0.1	V
			3.0 2.8	3.2		

2.7V Electrical Characteristics (Continued)

Unless otherwise specified, all limits guaranteed for at $T_J = 25^\circ\text{C}$, $V^+ = 2.7\text{V}$, $V^- = 0\text{V}$, $V_{\text{CM}} = V_O = V^+/2$, and $R_f = 2\text{k}\Omega$, and $R_L = 1\text{k}\Omega$ to $V^+/2$. **Boldface** limits apply at the temperature extremes.

Symbol	Parameter	Conditions	Min (Note 6)	Typ (Note 5)	Max (Note 6)	Units
CMRR	Common Mode Rejection Ratio	V_{CM} Stepped from 0V to 2.7V	46	77		dB
		V_{CM} Stepped from 0V to 1.55V	58	76		
A_{VOL}	Large Signal Voltage Gain	$V_O = 0.35\text{V}$ to 2.35V	76 74	87		dB
V_O	Output Swing High	$R_L = 1\text{k}$ to $V^+/2$	2.55	2.66		V
		$R_L = 10\text{k}$ to $V^+/2$		2.68		
	Output Swing Low	$R_L = 1\text{k}$ to $V^+/2$		40	150	mV
		$R_L = 10\text{k}$ to $V^+/2$		20		
I_{SC}	Output Short Circuit Current	Sourcing to V^- $V_{\text{ID}} = 200\text{mV}$ (Note 10)		43		mA
		Sinking to V^+ $V_{\text{ID}} = -200\text{mV}$ (Note 10)		42		
I_{OUT}	Output Current	$V_{\text{OUT}} = 0.5\text{V}$ from rails		± 20		mA
PSRR	Power Supply Rejection Ratio	$V^+ = 2.7\text{V}$ to 3.7V or $V^- = 0\text{V}$ to -1V	75	83		dB
I_S	Supply Current (per channel)	Normal Operation		650	1250	μA
		Shutdown Mode (LMH6647 only)		15	50	

5V Electrical Characteristics

Unless otherwise specified, all limits guaranteed for at $T_J = 25^\circ\text{C}$, $V^+ = 5\text{V}$, $V^- = 0\text{V}$, $V_{\text{CM}} = V_O = V^+/2$, and $R_f = 2\text{k}\Omega$, and $R_L = 1\text{k}\Omega$ to $V^+/2$. **Boldface** limits apply at the temperature extremes.

Symbol	Parameter	Conditions	Min (Note 6)	Typ (Note 5)	Max (Note 6)	Units
BW	-3dB BW	$A_V = +1$, $V_{\text{OUT}} = 200\text{mV}_{\text{PP}}$	40	55		MHz
e_n	Input-Referred Voltage Noise	$f = 100\text{kHz}$		17		$\text{nV}/\sqrt{\text{Hz}}$
		$f = 1\text{kHz}$		25		
i_n	Input-Referred Current Noise	$f = 100\text{kHz}$		0.75		$\text{pA}/\sqrt{\text{Hz}}$
		$f = 1\text{kHz}$		1.20		
CT Rej.	Cross-Talk Rejection (LMH6646 only)	$f = 5\text{MHz}$, Receiver: $R_f = R_g = 510\Omega$, $A_V = +2$		47		dB
SR	Slew Rate	$A_V = -1$, $V_O = 2\text{V}_{\text{PP}}$ (Note 8, 13)	15	22		$\text{V}/\mu\text{s}$
T_{ON}	Turn-On Time (LMH6647 only)			210		ns
T_{OFF}	Turn-Off Time (LMH6647 only)			500		ns
TH_{SD}	Shutdown Threshold (LMH6647 only)	$I_S \leq 50\mu\text{A}$		4.25	4.60	V
I_{SD}	Shutdown Pin Input Current (LMH6647 only)	(Note 7)		-20		μA
V_{OS}	Input Offset Voltage	$0\text{V} \leq V_{\text{CM}} \leq 5\text{V}$	-3 -4	± 1	3 4	mV
TC V_{OS}	Input Offset Average Drift	(Note 12)		± 5		$\mu\text{V}/\text{C}$
I_B	Input Bias Current	$V_{\text{CM}} = 4.8\text{V}$ (Note 7)		+0.36	+2 -2.2	μA
		$V_{\text{CM}} = 0.5\text{V}$ (Note 7)		-0.68	-2 -2.2	
I_{OS}	Input Offset Current	$0\text{V} \leq V_{\text{CM}} \leq 5\text{V}$		1	500	nA
R_{IN}	Common Mode Input Resistance			3		$\text{M}\Omega$

5V Electrical Characteristics (Continued)

Unless otherwise specified, all limits guaranteed for at $T_J = 25^\circ\text{C}$, $V^+ = 5\text{V}$, $V^- = 0\text{V}$, $V_{\text{CM}} = V_O = V^+/2$, and $R_f = 2\text{k}\Omega$, and $R_L = 1\text{k}\Omega$ to $V^+/2$. **Boldface** limits apply at the temperature extremes.

Symbol	Parameter	Conditions	Min (Note 6)	Typ (Note 5)	Max (Note 6)	Units
C_{IN}	Common Mode Input Capacitance			2		pF
CMVR	Input Common-Mode Voltage Range	CMRR $\geq 50\text{dB}$		-0.5	-0.3	V
				5.3 5.1	5.5	
CMRR	Common Mode Rejection Ratio	V_{CM} Stepped from 0V to 5V	56	82		dB
		V_{CM} Stepped from 0V to 3.8V	66	85		
A_{VOL}	Large Signal Voltage Gain	$V_O = 1.5\text{V}$ to 3.5V	76 74	85		dB
V_O	Output Swing High	$R_L = 1\text{k}$ to $V^+/2$	4.80	4.95		V
		$R_L = 10\text{k}$ to $V^+/2$		4.98		
	Output Swing Low	$R_L = 1\text{k}$ to $V^+/2$		50	200	mV
		$R_L = 10\text{k}$ to $V^+/2$		20		
I_{SC}	Output Short Circuit Current	Sourcing to V^- $V_{\text{ID}} = 200\text{mV}$ (Note 10)		55		mA
		Sinking to V^+ $V_{\text{ID}} = -200\text{mV}$ (Note 10)		53		
I_{OUT}	Output Current	$V_{\text{OUT}} = 0.5\text{V}$ From rails		± 20		mA
PSRR	Power Supply Rejection Ratio	$V^+ = 5\text{V}$ to 6V or $V^- = 0\text{V}$ to -1V	75	95		dB
I_{S}	Supply Current (per channel)	Normal Operation		700	1400	μA
		Shutdown Mode (LMH6647 only)		10	50	

$\pm 5\text{V}$ Electrical Characteristics

Unless otherwise specified, all limits guaranteed for at $T_J = 25^\circ\text{C}$, $V^+ = 5\text{V}$, $V^- = -5\text{V}$, $V_{\text{CM}} = V_O = 0\text{V}$, $R_f = 2\text{k}\Omega$, and $R_L = 1\text{k}\Omega$ to GND. **Boldface** limits apply at the temperature extremes.

Symbol	Parameter	Conditions	Min (Note 6)	Typ (Note 5)	Max (Note 6)	Units
BW	-3dB BW	$A_V = +1$, $V_{\text{OUT}} = 200\text{mV}_{\text{PP}}$	40	55		MHz
e_n	Input-Referred Voltage Noise	$f = 100\text{kHz}$		17		$\text{nV}/\sqrt{\text{Hz}}$
		$f = 1\text{kHz}$		25		
i_n	Input-Referred Current Noise	$f = 100\text{kHz}$		0.75		$\text{pA}/\sqrt{\text{Hz}}$
		$f = 1\text{kHz}$		1.20		
CT Rej.	Cross-Talk Rejection (LMH6646 only)	$f = 5\text{MHz}$, Receiver: $R_f = R_g = 510\Omega$, $A_V = +2$		47		dB
SR	Slew Rate	$A_V = -1$, $V_O = 2V_{\text{PP}}$ (Note 8)	15	22		$\text{V}/\mu\text{s}$
T_{ON}	Turn-On Time (LMH6647 only)			200		ns
T_{OFF}	Turn-Off Time (LMH6647 only)			700		ns
TH_{SD}	Shutdown Threshold (LMH6647 only)	$I_{\text{S}} \leq 50\mu\text{A}$		4.25	4.60	V
I_{SD}	Shutdown Pin Input Current (LMH6647 only)	(Note 7)		-20		μA
V_{OS}	Input Offset Voltage	$-5\text{V} \leq V_{\text{CM}} \leq 5\text{V}$	-3 -4	± 1	3 4	mV
TC V_{OS}	Input Offset Average Drift	(Note 12)		± 5		$\mu\text{V}/^\circ\text{C}$

±5V Electrical Characteristics (Continued)

Unless otherwise specified, all limits guaranteed for at $T_J = 25^\circ\text{C}$, $V^+ = 5\text{V}$, $V^- = -5\text{V}$, $V_{\text{CM}} = V_O = 0\text{V}$, $R_f = 2\text{k}\Omega$, and $R_L = 1\text{k}\Omega$ to GND. **Boldface** limits apply at the temperature extremes.

Symbol	Parameter	Conditions	Min (Note 6)	Typ (Note 5)	Max (Note 6)	Units
I_B	Input Bias Current	$V_{\text{CM}} = 4.8\text{V}$ (Note 7)		+0.40	+2 +2.2	μA
		$V_{\text{CM}} = -4.5\text{V}$ (Note 7)		-0.65	-2 -2.2	
I_{OS}	Input Offset Current	$-5\text{V} \leq V_{\text{CM}} \leq 5\text{V}$		3	500	nA
R_{IN}	Common Mode Input Resistance			3		M Ω
C_{IN}	Common Mode Input Capacitance			2		pF
CMVR	Input Common-Mode Voltage Range	CMRR $\geq 50\text{dB}$		-5.5	-5.3 -5.1	V
			5.3 5.1	5.5		
CMRR	Common Mode Rejection Ratio	V_{CM} Stepped from -5V to 5V	60	84		dB
		V_{CM} Stepped from -5V to 3.5V	66	104		
A_{VOL}	Large Signal Voltage Gain	$V_O = -2\text{V}$ to 2V	76 74	85		dB
V_O	Output Swing High	$R_L = 1\text{k}\Omega$	4.70	4.92		V
		$R_L = 10\text{k}\Omega$		4.97		
	Output Swing Low	$R_L = 1\text{k}\Omega$		-4.93	-4.70	V
		$R_L = 10\text{k}\Omega$		-4.98		
I_{SC}	Output Short Circuit Current	Sourcing to V^- $V_{\text{ID}} = 200\text{mV}$ (Note 10)		66		mA
		Sinking to V^+ $V_{\text{ID}} = -200\text{mV}$ (Note 10)		61		
I_{OUT}	Output Current	$V_{\text{OUT}} = 0.5\text{V}$ from rails		± 20		mA
PSRR	Power Supply Rejection Ratio	$V^+ = 5\text{V}$ to 6V or $V^- = -5\text{V}$ to -6V	76	95		dB
I_S	Supply Current (per channel)	Normal Operation		725	1600	μA
		Shutdown Mode (LMH6647 only)		10	50	

Note 1: Absolute Maximum Ratings indicate limits beyond which damage to the device may occur. Operating Ratings indicate conditions for which the device is intended to be functional, but specific performance is not guaranteed. For guaranteed specifications and the test conditions, see the Electrical Characteristics.

Note 2: Human body model, $1.5\text{k}\Omega$ in series with 100pF .

Note 3: Applies to both single-supply and split-supply operation. Continuous short circuit operation at elevated ambient temperature can result in exceeding the maximum allowed junction temperature of 150°C .

Note 4: The maximum power dissipation is a function of $T_{\text{J(MAX)}}$, θ_{JA} , and T_A . The maximum allowable power dissipation at any ambient temperature is $P_D = (T_{\text{J(MAX)}} - T_A) / \theta_{\text{JA}}$. All numbers apply for packages soldered directly onto a PC board.

Note 5: Typical values represent the most likely parametric norm.

Note 6: All limits are guaranteed by testing or statistical analysis.

Note 7: Positive current corresponds to current flowing into the device.

Note 8: Slew rate is the average of the rising and falling slew rates.

Note 9: Machine Model, 0Ω in series with 200pF .

Note 10: Short circuit test is a momentary test. See Note 11.

Note 11: Output short circuit duration is infinite for $V_S < 6\text{V}$ at room temperature and below. For $V_S > 6\text{V}$, allowable short circuit duration is 1.5ms .

Note 12: Offset voltage average drift determined by dividing the change in V_{OS} at temperature extremes into the total temperature change.

Note 13: Guaranteed based on characterization only.

Typical Performance Characteristics At $T_J = 25^\circ\text{C}$. Unless otherwise specified.

Closed Loop Frequency Response for Various Temperature

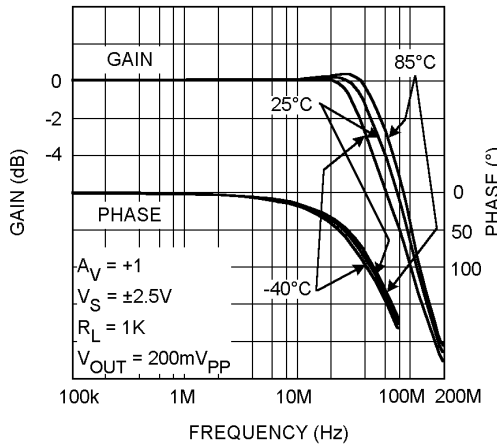

20020249

Frequency Response for Various AV

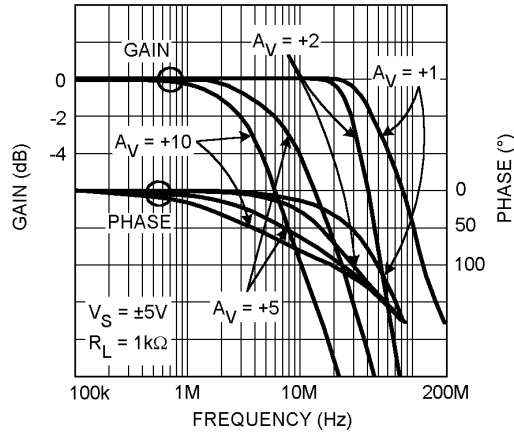

20020248

Open Loop Gain/Phase vs. Frequency for Various Temperature

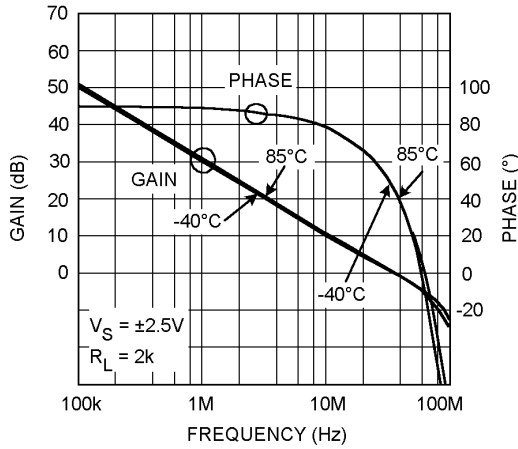

20020250

THD vs. Output Swing

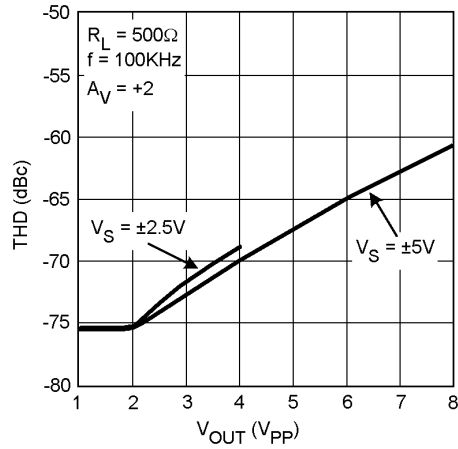

20020253

THD vs. Output Swing

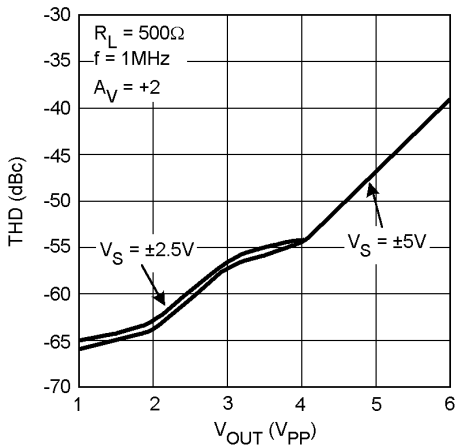

20020254

Output Swing vs. Frequency

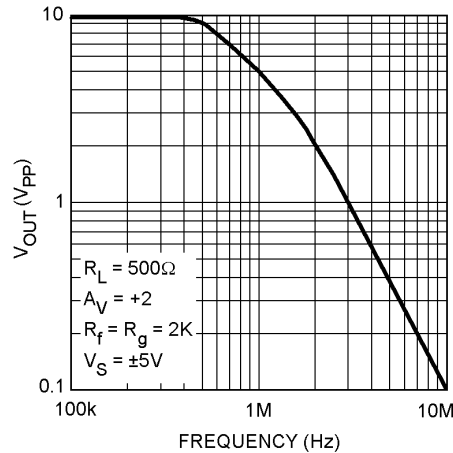

20020255

Typical Performance Characteristics At $T_J = 25^\circ\text{C}$. Unless otherwise specified. (Continued)

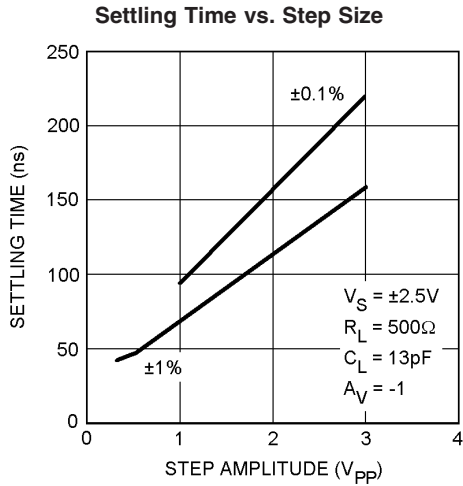

20020252

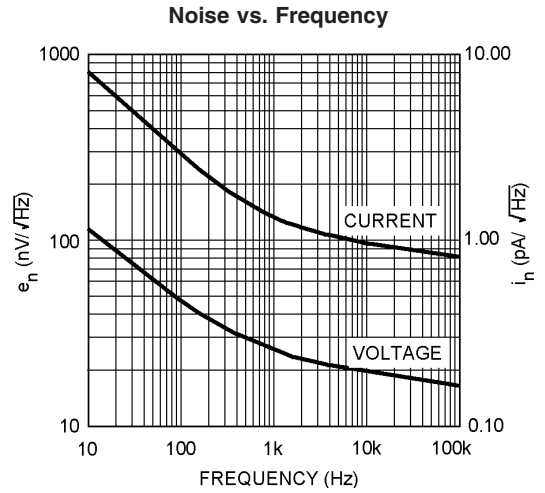

20020234

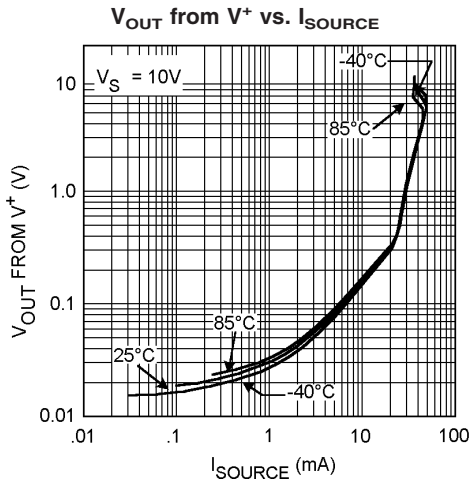

20020237

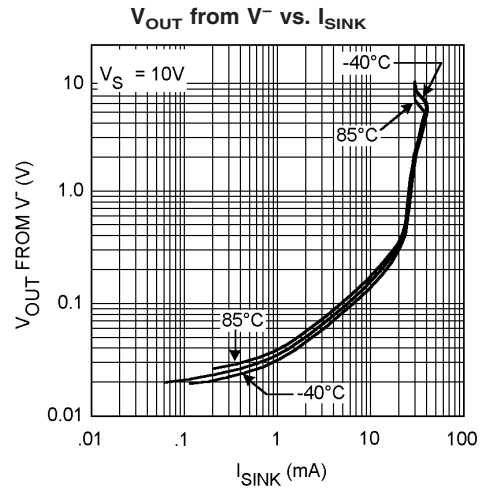

20020238

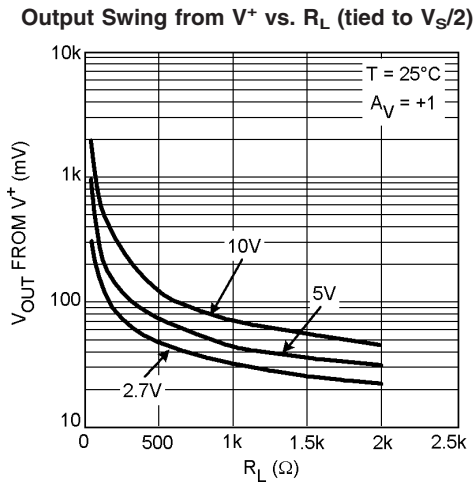

20020202

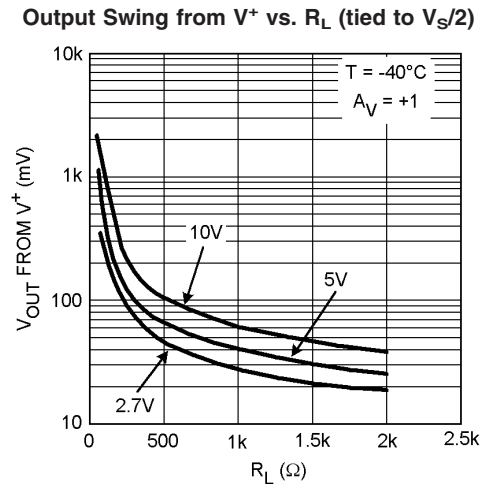

20020206

Typical Performance Characteristics At $T_J = 25^\circ\text{C}$. Unless otherwise specified. (Continued)

Output Swing from V^+ vs. R_L (tied to $V_S/2$)

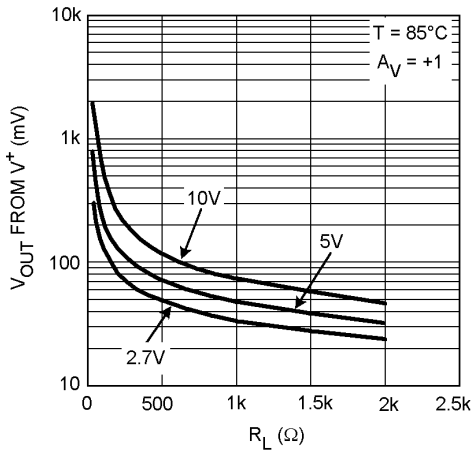

20020204

Output Swing from V^- vs. R_L (tied to $V_S/2$)

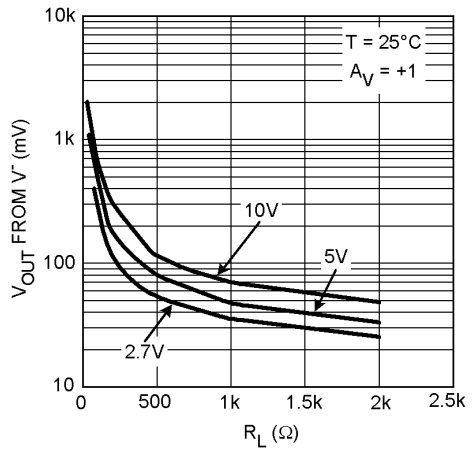

20020203

Output Swing from V^- vs. R_L (tied to $V_S/2$)

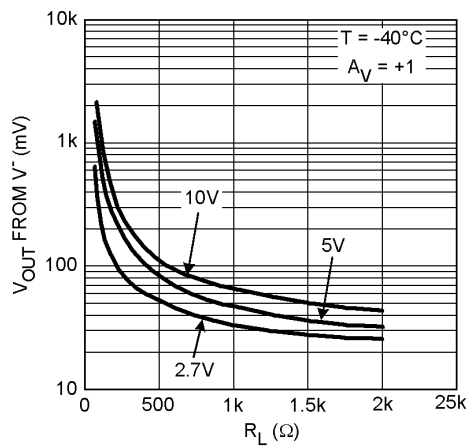

20020207

Output Swing from V^- vs. R_L (tied to $V_S/2$)

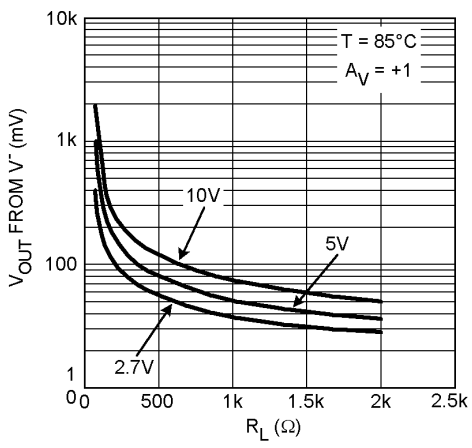

20020205

Cap Load Tolerance and Setting Time vs. Closed Loop Gain

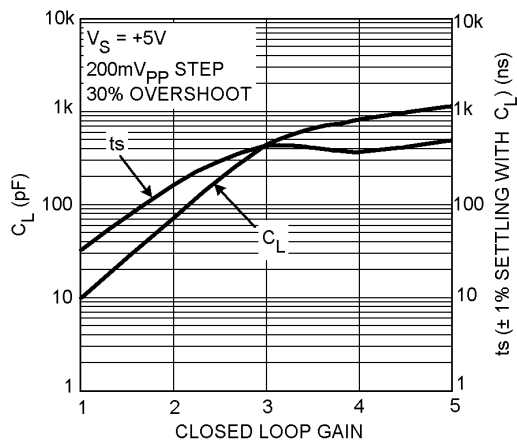

20020201

Z_{OUT} vs. Frequency

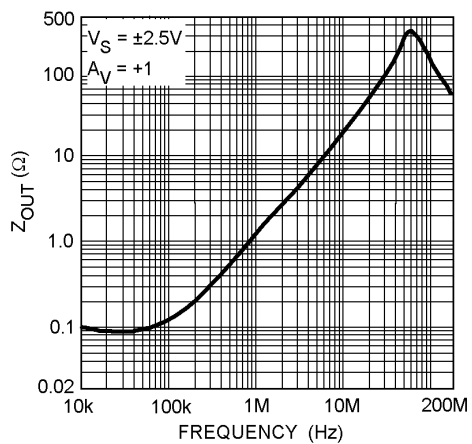

20020216

Typical Performance Characteristics At $T_J = 25^\circ\text{C}$. Unless otherwise specified. (Continued)

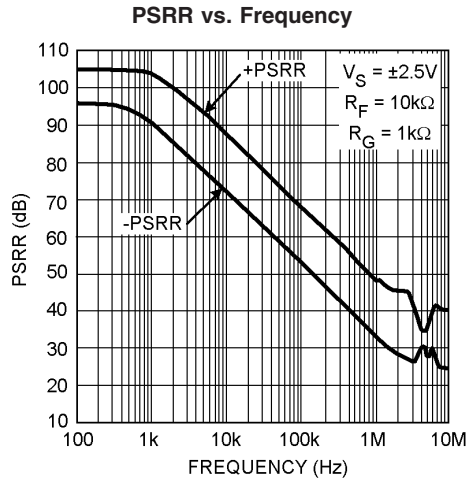

20020247

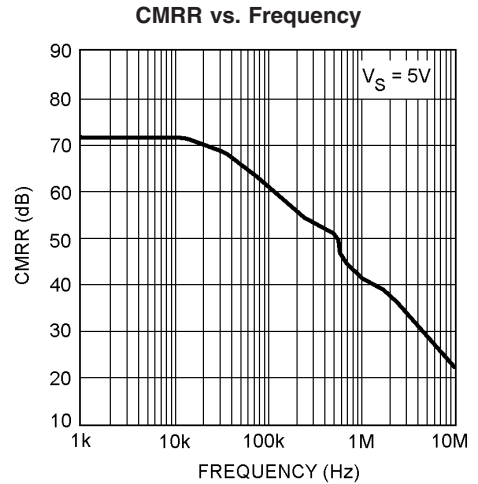

20020251

Crosstalk Rejection vs. Frequency (Output to Output) (LMH6646)

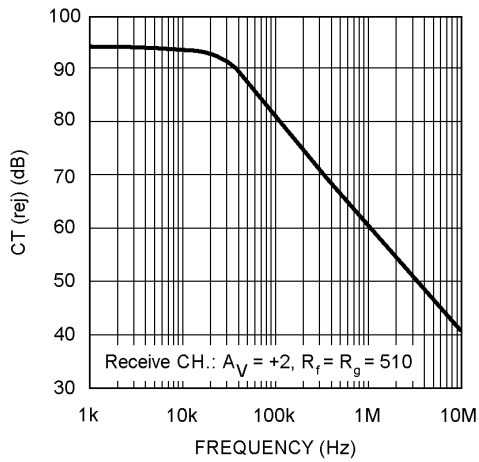

20020257

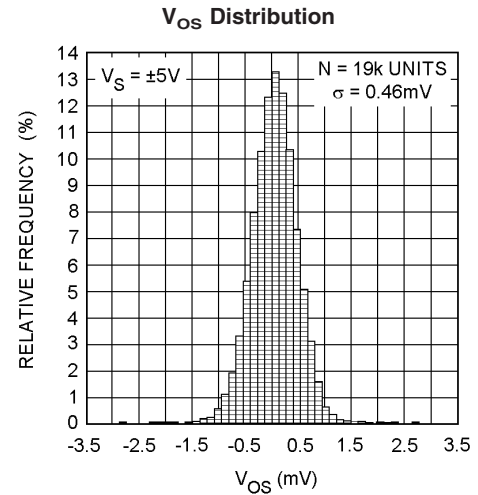

20020225

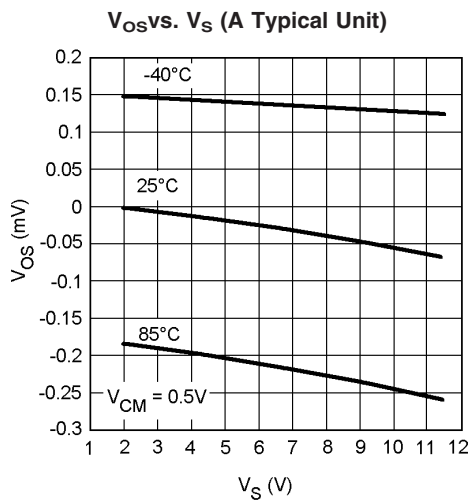

20020218

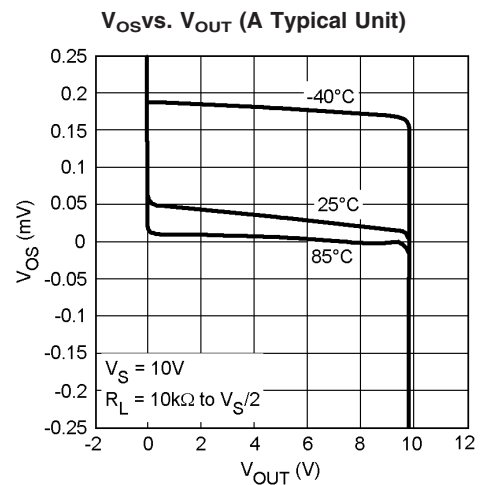

20020228

Typical Performance Characteristics At $T_J = 25^\circ\text{C}$. Unless otherwise specified. (Continued)

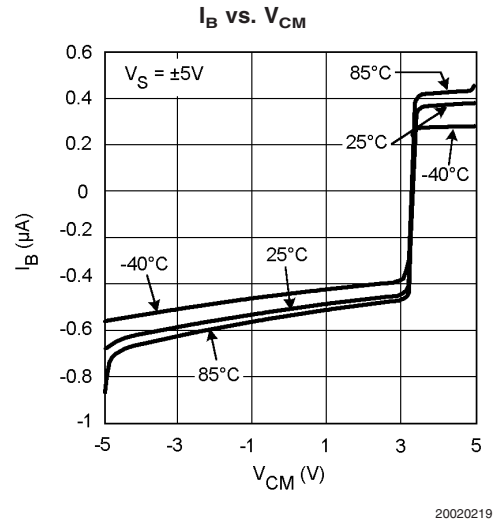
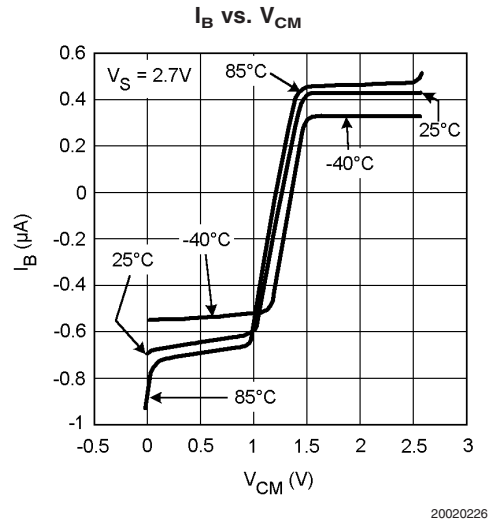
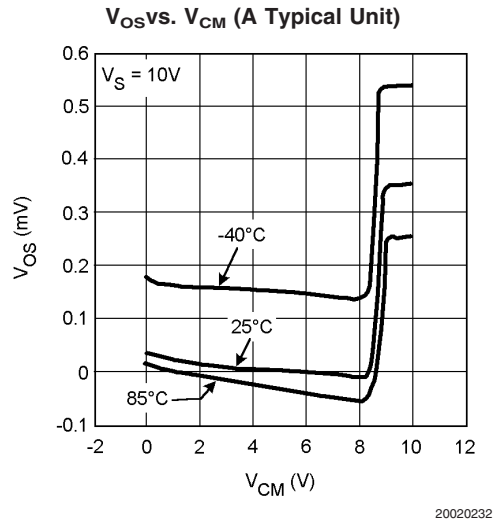
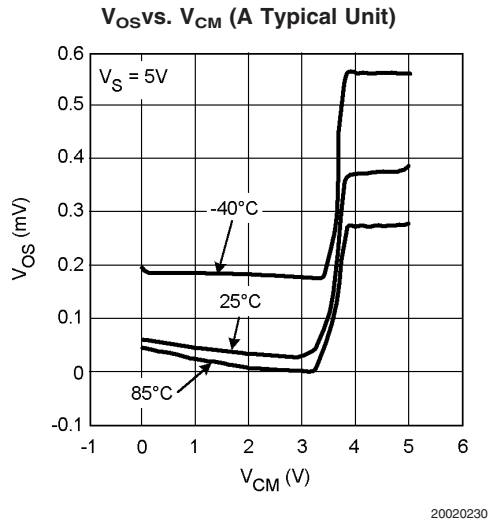
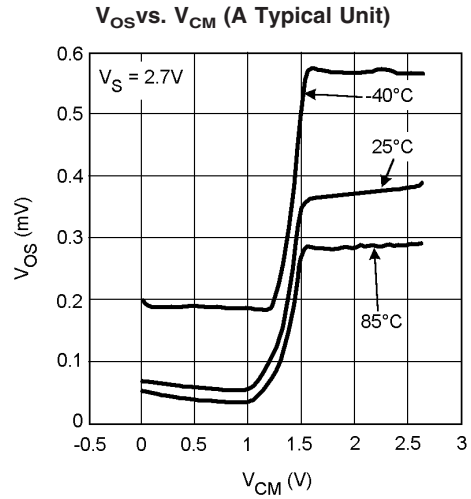
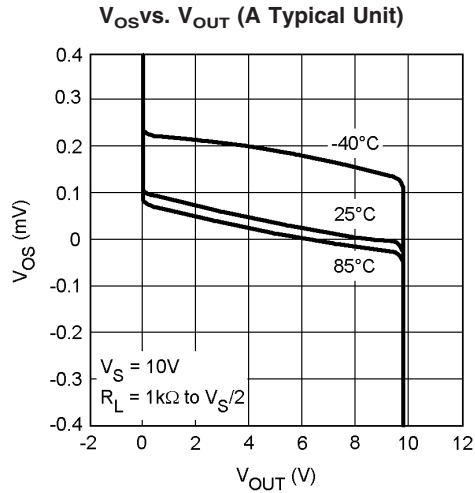

Typical Performance Characteristics At $T_J = 25^\circ\text{C}$. Unless otherwise specified. (Continued)

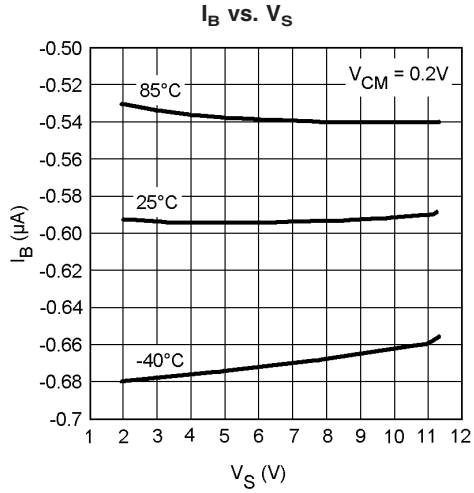

20020227

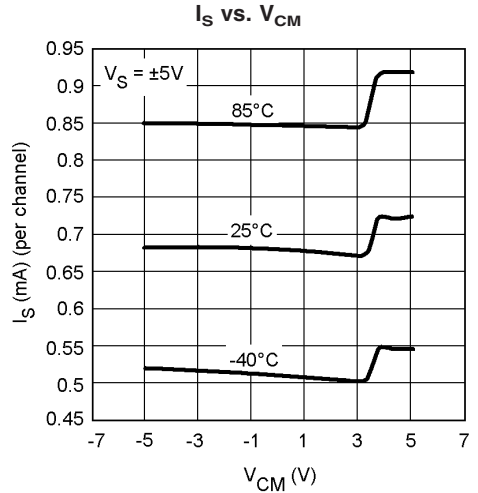

20020223

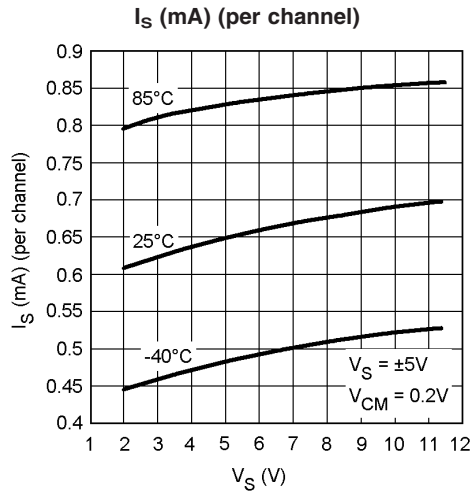

20020224

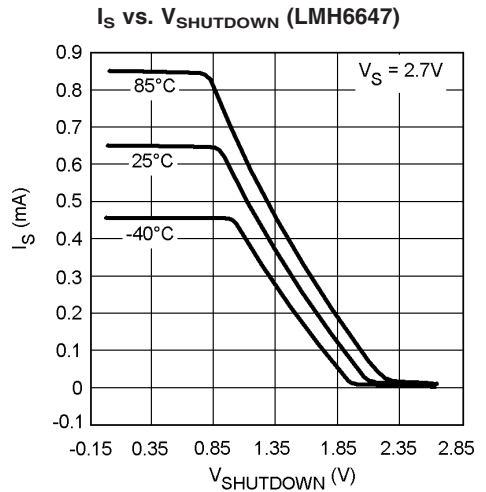

20020221

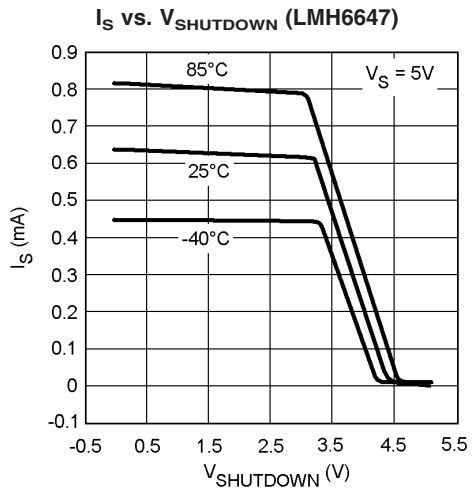

20020220

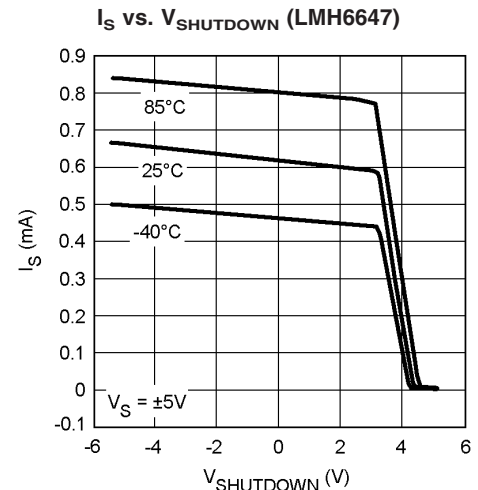

20020222

Typical Performance Characteristics At $T_J = 25^\circ\text{C}$. Unless otherwise specified. (Continued)

Shutdown Pin and Supply Current vs. Shutdown Voltage

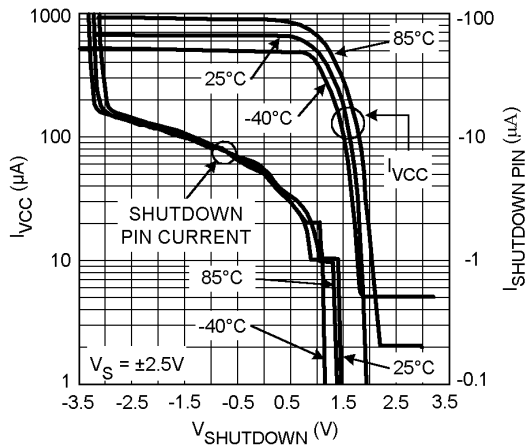

20020208

Small Signal Step Response

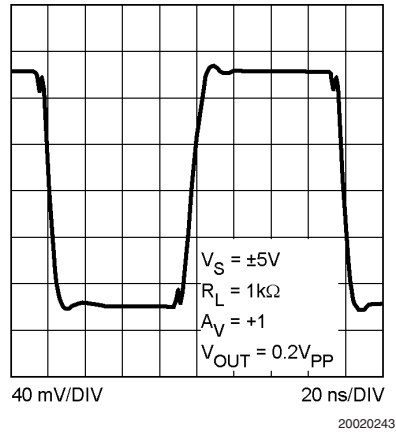

20020243

Large Signal Step Response

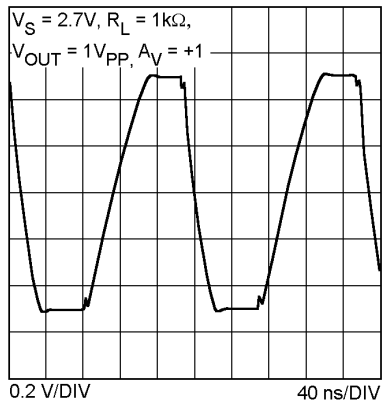

20020244

Large Signal Step Response

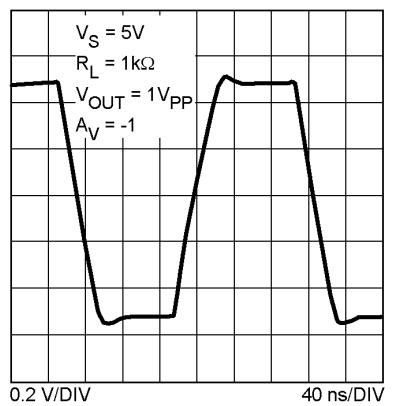

20020245

Output Overload Recovery

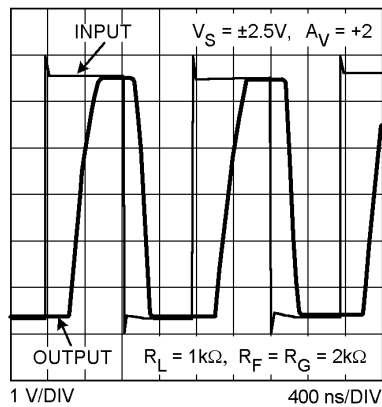

20020246

Application Notes

CIRCUIT DESCRIPTION

The LMH6645/6646/6647 family is based on National Semiconductor's proprietary VIP10 dielectrically isolated bipolar process.

This device family architecture features the following:

- Complimentary bipolar devices with exceptionally high f_t (~8GHz) even under low supply voltage (2.7V) and low Collector bias current.
- Rail-to-Rail input which allows the input common mode voltage to go beyond either rail by about 0.5V typically.
- A class A-B "turn-around" stage with improved noise, offset, and reduced power dissipation compared to similar speed devices (patent pending).
- Common Emitter push-pull output stage capable of 20mA output current (at 0.5V from the supply rails) while consuming only ~700 μ A of total supply current per channel. This architecture allows output to reach within milli-volts of either supply rail at light loads.
- Consistent performance from any supply voltage (2.7V-10V) with little variation with supply voltage for the most important specifications (e.g. BW, SR, I_{OUT} , etc.)

APPLICATION HINTS

The total input common mode voltage range, which extends from below V^- to beyond V^+ , is covered by both a PNP and a NPN stage. The NPN stage is switched on whenever the input is less than 1.2V from V^+ and the PNP stage covers the rest of the range. In terms of the input voltage, there is an overlapping region where both stages are processing the input signal. This region is about 0.5V from beginning to the end. As far as the device application is concerned, this transition is a transparent operation. However, keep in mind that the input bias current value and direction will depend on which input stage is operating (see typical performance characteristics for plots). For low distortion applications, it is best to keep the input common mode voltage from transversing this transition point. Low gain settling applications, which generally encounter larger peak-to-peak input voltages, could be configured as inverting stages to eliminate common mode voltage fluctuations.

In terms of the output, when the output swing approaches either supply rail, the output transistor will enter a Quasi-saturated state. A subtle effect of this operational region is that there is an increase in supply current in this state (up to 1mA). The onset of Quasi-saturation region is a function of output loading (current) and varies from 100mV at no load to about 1V when output is delivering 20mA, as measured from supplies. Both input common mode voltage and output voltage level effect the supply current (see typical performance characteristics for plot).

With 2.7V supplies and a common mode input voltage range that extends beyond either supply rail, the LMH6645/6646/6647 family is well suited to many low voltage/low power applications. Even with 2.7V supplies, the -3dB BW (@ $A_V = +1$) is typically 55MHz with a tested limit of 45MHz. Production testing guarantees that process variations will not compromise speed.

This device family is designed to avoid output phase reversal. With input over-drive, the output is kept near the supply rail (or as close to it as mandated by the closed loop gain setting and the input voltage). *Figure 1*, below, shows the input and output voltage when the input voltage significantly exceeds the supply voltages:

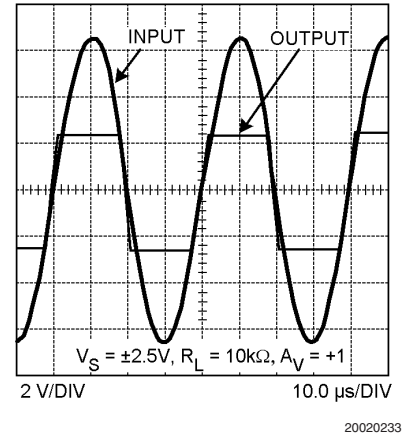

FIGURE 1. Input/Output Shown with Exceeded Input CMVR

As can be seen, the output does not exhibit any phase reversal as some op amps do. However, if the input voltage range is exceeded by more than a diode drop beyond either rail, the internal ESD protection diodes will start to conduct. The current flow in these ESD diodes should be externally limited.

LMH6647 MICRO-POWER SHUTDOWN

The LMH6647 can be shutdown to save power and reduce its supply current to less than 50 μ A guaranteed, by applying a voltage to the SD pin. The SD pin is "active high" and needs to be tied to V^- for normal operation. This input is low current (<20 μ A, 4pF equivalent capacitance) and a resistor to V^- ($\leq 20k\Omega$) will result in normal operation. Shutdown is guaranteed when SD pin is 0.4V or less from V^+ at any operating supply voltage and temperature.

In the shutdown mode, essentially all internal device biasing is turned off in order to minimize supply current flow and the output goes into Hi-Z (high impedance) mode. Complete device Turn-on and Turn-off times vary considerably relative to the output loading conditions, output voltage, and input impedance, but is generally limited to less than 1 μ s (see tables for actual data).

Application Notes (Continued)

During shutdown, the input stage has an equivalent circuit as shown below in *Figure 2*

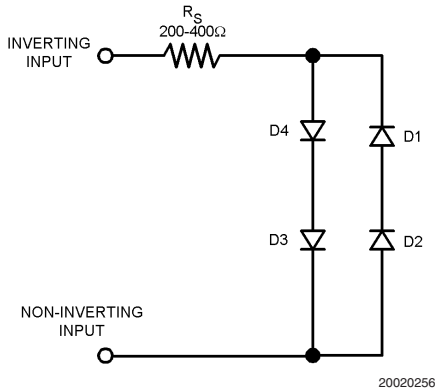

FIGURE 2. LMH6647 Equivalent Input in Shutdown Mode

As can be seen above, in shutdown, there may be current flow through the internal diodes shown, caused by input potential, if present. This current may flow through the external feedback resistor and result in an apparent output signal. In most shutdown applications the presence of this output is inconsequential. However, if the output is “forced” by another device such as in a multiplexer, the other device will need to conduct the current described in order to maintain the output potential.

To keep the output at or near ground during shutdown when there is no other device to hold the output low, a switch (transistor) could be used to shunt the output to ground. *Figure 3* shows a circuit where a NPN bipolar is used to keep the output near ground (-80mV):

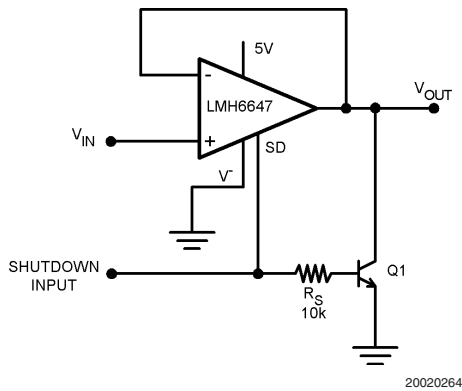

FIGURE 3. Active Pull-Down Schematic

Figure 4 shows the output waveform.

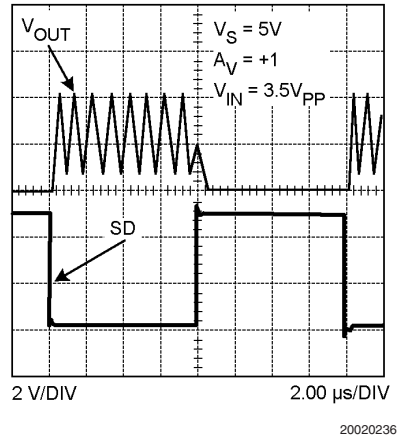

FIGURE 4. Output Held Low by Active Pull-Down Circuit

If bipolar transistor power dissipation is not tolerable, the switch could be by a N-channel enhancement mode MOSFET.

2.7V SINGLE SUPPLY RRIO 2:1 MUX

The schematic show in *Figure 5* will function as a 2:1 MUX operating on a single 2.7V power supply, by utilizing the shutdown feature of the LMH6647:

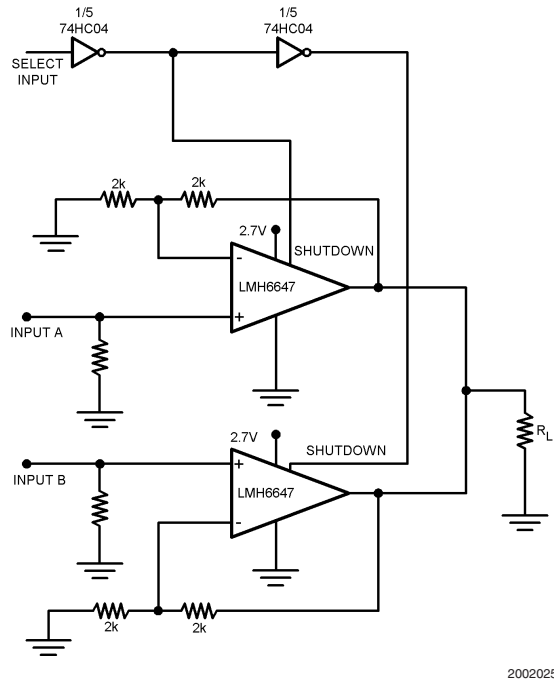

FIGURE 5. 2:1 MUX Operating off a 2.7V Single Supply

Application Notes (Continued)

Figure 6 shows the MUX output when selecting between a 1MHz sine and a 250KHz triangular waveform.

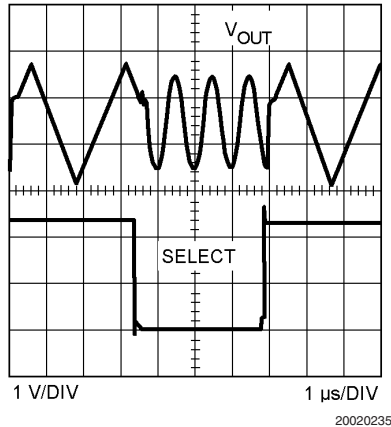

FIGURE 6. 2:1 MUX Output

As can be seen in *Figure 6*, the output is well behaved and there are no spikes or glitches due to the switching. Switching times are approximately around 500ns based on the time when the output is considered “valid”.

PRINTED CIRCUIT BOARD LAYOUT, COMPONENT VALUES SELECTION, AND EVALUATION BOARDS

Generally, a good high-frequency layout will keep power supply and ground traces away from the inverting input and output pins. Parasitic capacitances on these nodes to

ground will cause frequency response peaking and possible circuit oscillations (see Application Note OA-15 for more information).

Another important parameter in working with high speed/high performance amplifiers, is the component values selection. Choosing large valued external resistors, will effect the closed loop behavior of the stage because of the interaction of these resistors with parasitic capacitances. These capacitors could be inherent to the device or a by-product of the board layout and component placement. Either way, keeping the resistor values lower, will diminish this interaction. On the other hand, choosing very low value resistors could load down nodes and will contribute to higher overall power dissipation.

National Semiconductor suggests the following evaluation boards as a guide for high frequency layout and as an aid in device testing and characterization:

Device	Package	Evaluation Board PN
LMH6645MF	SOT23-5	CLC730068
LMH6645MA	8-Pin SOIC	CLC730027
LMH6646MA	8-Pin SOIC	CLC730036
LMH6646MM	8-Pin MSOP	CLC730123
LMH6647MA	8-Pin SOIC	CLC730027
LMH6647MF	SOT23-6	CLC730116

These free evaluation boards are shipped when a device sample request is placed with National Semiconductor.

LMH6647 Evaluation

For normal operation, tie the SD pin to V^- .

Physical Dimensions inches (millimeters) unless otherwise noted

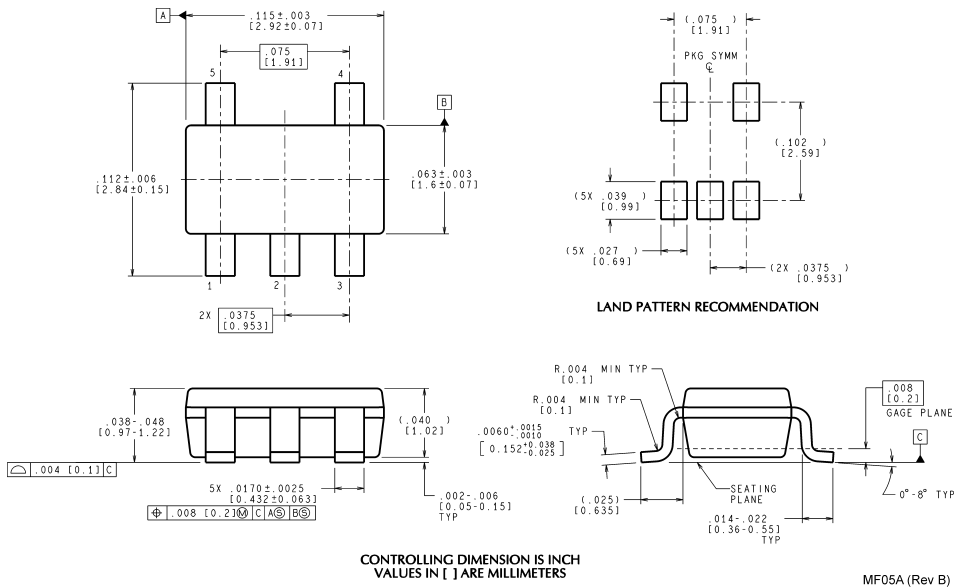

**5-Pin SOT23
NS Package Number MF05A**

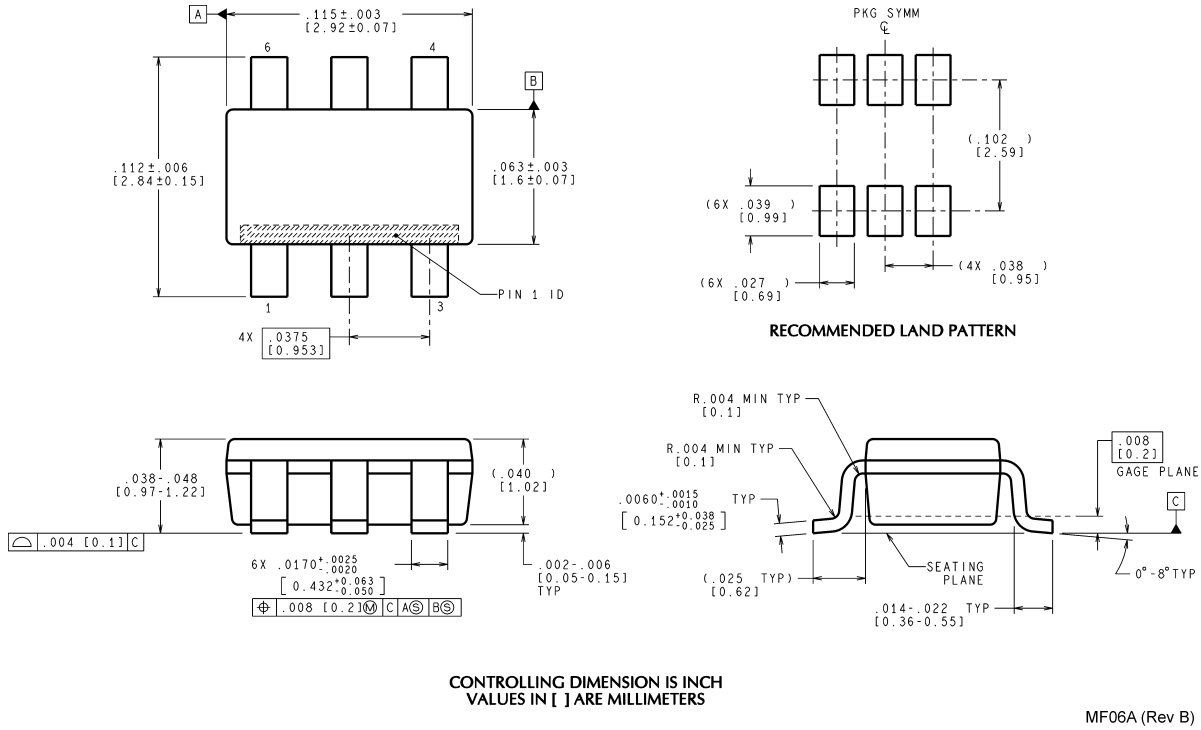

**6-Pin SOT23
NS Package Number MF06A**

Physical Dimensions inches (millimeters) unless otherwise noted (Continued)

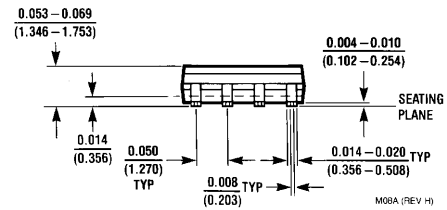
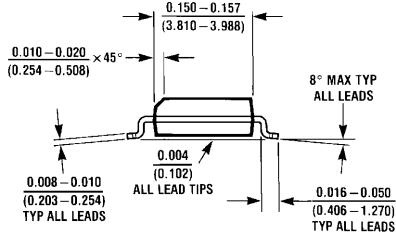
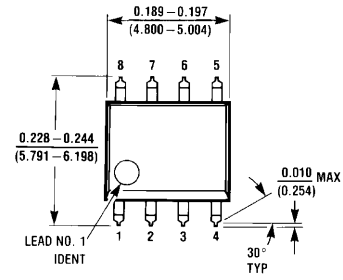

8-Pin SOIC
NS Package Number M08A

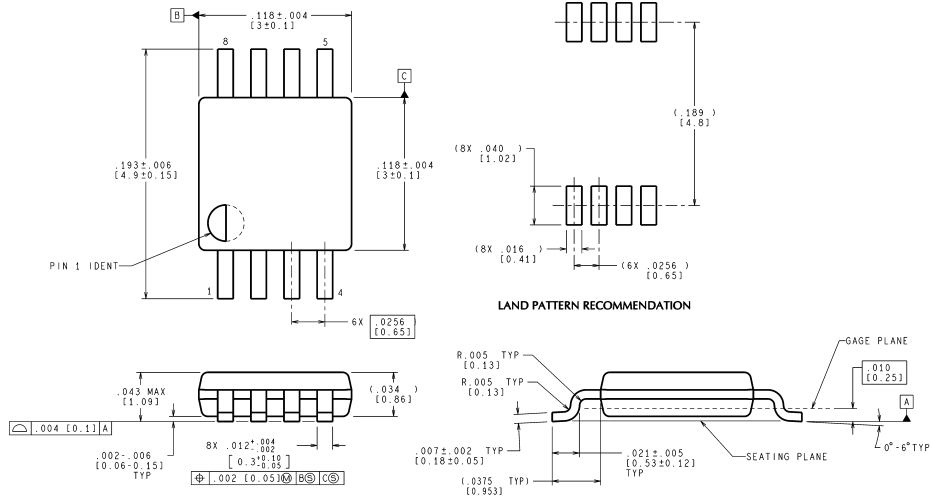

CONTROLLING DIMENSION IS INCH
VALUES IN [] ARE MILLIMETERS

MUA08A (Rev E)

8Pin MSOP
NS Package Number MUA08A

Notes

National does not assume any responsibility for use of any circuitry described, no circuit patent licenses are implied and National reserves the right at any time without notice to change said circuitry and specifications.
 For the most current product information visit us at www.national.com.

LIFE SUPPORT POLICY

NATIONAL'S PRODUCTS ARE NOT AUTHORIZED FOR USE AS CRITICAL COMPONENTS IN LIFE SUPPORT DEVICES OR SYSTEMS WITHOUT THE EXPRESS WRITTEN APPROVAL OF THE PRESIDENT AND GENERAL COUNSEL OF NATIONAL SEMICONDUCTOR CORPORATION. As used herein:

- | | |
|--|---|
| <p>1. Life support devices or systems are devices or systems which, (a) are intended for surgical implant into the body, or (b) support or sustain life, and whose failure to perform when properly used in accordance with instructions for use provided in the labeling, can be reasonably expected to result in a significant injury to the user.</p> | <p>2. A critical component is any component of a life support device or system whose failure to perform can be reasonably expected to cause the failure of the life support device or system, or to affect its safety or effectiveness.</p> |
|--|---|

BANNED SUBSTANCE COMPLIANCE

National Semiconductor manufactures products and uses packing materials that meet the provisions of the Customer Products Stewardship Specification (CSP-9-111C2) and the Banned Substances and Materials of Interest Specification (CSP-9-111S2) and contain no "Banned Substances" as defined in CSP-9-111S2.

Leadfree products are RoHS compliant.



National Semiconductor
Americas Customer
Support Center
 Email: new.feedback@nsc.com
 Tel: 1-800-272-9959

National Semiconductor
Europe Customer Support Center
 Fax: +49 (0) 180-530 85 86
 Email: europe.support@nsc.com
 Deutsch Tel: +49 (0) 69 9508 6208
 English Tel: +44 (0) 870 24 0 2171
 Français Tel: +33 (0) 1 41 91 8790

National Semiconductor
Asia Pacific Customer
Support Center
 Email: ap.support@nsc.com

National Semiconductor
Japan Customer Support Center
 Fax: 81-3-5639-7507
 Email: jpn.feedback@nsc.com
 Tel: 81-3-5639-7560