

Features

- Fast Switching Speed: $t_r \leq 4.0\text{ns}$
- Low Leakage Current: $I_R \leq 25\text{nA}$
- Low Capacitance: $C_T \leq 4\text{pF}$
- Flat Lead for High Thermal Efficiency
- Small Surface Mount Package
- **Lead, Halogen and Antimony Free, RoHS Compliant (Note 1)**
- **"Green" Device (Note 2)**
- **Qualified to AEC-Q101 Standards for High Reliability**

Mechanical Data

- Case: SOD323F
- Case Material: Molded Plastic, "Green Molding Compound".
UL Flammability Classification Rating 94V-0
- Moisture Sensitivity: Level 1 per J-STD-020
- Terminal Connections: Cathode Band
- Terminals: Finish - Matte Tin annealed over Copper Alloy leadframe. Solderable per MIL-STD-202, Method 208
- Weight: 0.007 grams (approximate)

SOD323F

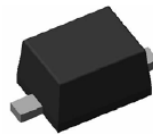

Top View

Ordering Information (Note 3)

Part Number	Qualification	Case	Packaging
1N4448WSF-7	Commercial	SOD323F	3000/Tape & Reel
1N4448WSFQ-7	Automotive	SOD323F	3000/Tape & Reel

- Notes:
1. No purposefully added lead. Halogen and Antimony Free.
 2. Diodes Inc.'s "Green" policy can be found on our website at <http://www.diodes.com>.
 3. For packaging details, go to our website at <http://www.diodes.com>.

Marking Information



TK = Product Type Marking Code
 YM = Date Code Marking
 Y = Year (ex: Y = 2011)
 M = Month (ex: 9 = September)

Date Code Key

Year Code	2011	2012	2013	2014	2015	2016	2017	2018
Code	Y	Z	A	B	C	D	E	F

Month Code	Jan	Feb	Mar	Apr	May	Jun	Jul	Aug	Sep	Oct	Nov	Dec
Code	1	2	3	4	5	6	7	8	9	O	N	D

Maximum Ratings @ $T_A = 25^\circ\text{C}$ unless otherwise specified

Characteristic	Symbol	Value	Unit
Non-Repetitive Peak Reverse Voltage	V_{RM}	100	V
Peak Repetitive Reverse Voltage	V_{RRM}	75	V
Working Peak Reverse Voltage	V_{RWM}		
DC Blocking Voltage	V_R		
RMS Reverse Voltage	$V_{R(RMS)}$	53	V
Forward Continuous Current	I_{FM}	500	mA
Average Rectified Output Current	I_O	250	mA
Non-Repetitive Peak Forward Surge Current	I_{FSM}	@ $t = 1.0\mu\text{s}$	4
		@ $t = 1.0\text{s}$	0.5

Thermal Characteristics

Characteristic	Symbol	Value	Unit
Power Dissipation (Note 4)	P_D	400	mW
Thermal Resistance Junction to Ambient Air (Note 4)	$R_{\theta JA}$	313	$^\circ\text{C/W}$
Operating and Storage Temperature Range	T_J, T_{STG}	-65 to +150	$^\circ\text{C}$

Electrical Characteristics @ $T_A = 25^\circ\text{C}$ unless otherwise specified

Characteristic	Symbol	Min	Max	Unit	Test Condition
Reverse Breakdown Voltage (Note 5)	$V_{(BR)R}$	75	—	V	$I_R = 100\mu\text{A}$
Forward Voltage	V_F	0.62	0.72	V	$I_F = 5.0\text{mA}$
		—	0.855		$I_F = 10\text{mA}$
		—	1.0		$I_F = 100\text{mA}$
		—	1.25		$I_F = 150\text{mA}$
Leakage Current (Note 5)	I_R	—	2.5	μA	$V_R = 75\text{V}$
		—	50	μA	$V_R = 75\text{V}, T_J = 150^\circ\text{C}$
		—	30	μA	$V_R = 25\text{V}, T_J = 150^\circ\text{C}$
		—	25	nA	$V_R = 20\text{V}$
Total Capacitance	C_T	—	4.0	pF	$V_R = 0, f = 1.0\text{MHz}$
Reverse Recovery Time	t_{rr}	—	4.0	ns	$I_F = I_R = 10\text{mA}, I_{rr} = 0.1 \times I_R, R_L = 100\Omega$

- Notes:
- Part mounted on FR-4 PC board with minimum recommended pad layouts, which can be found on our website at <http://www.diodes.com>.
 - Short duration pulse test used to minimize self-heating.

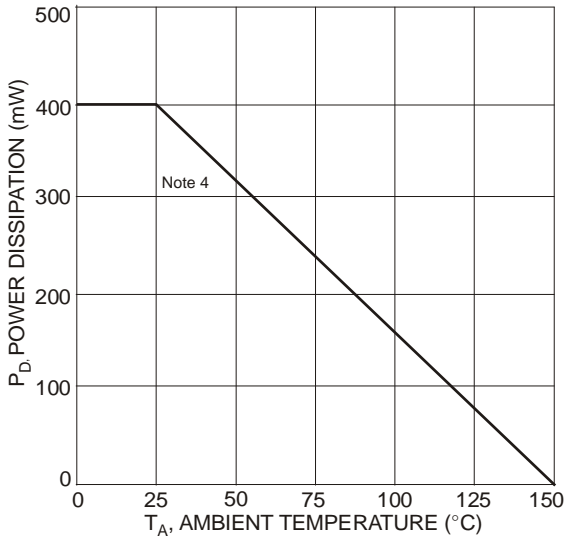

Fig. 1 Forward Current Derating Curve

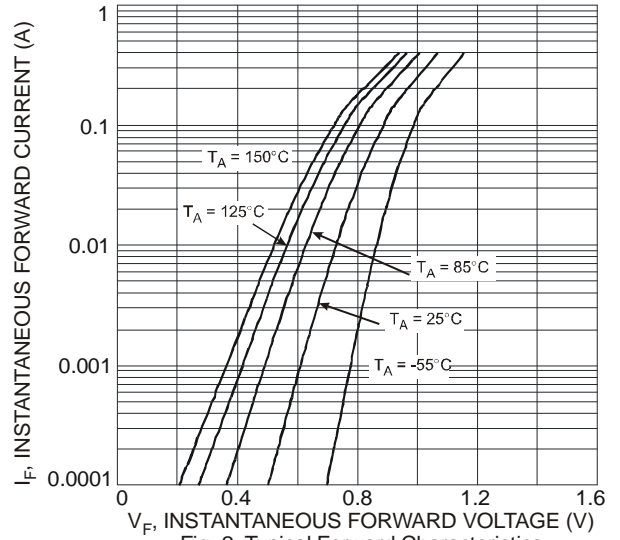

Fig. 2 Typical Forward Characteristics

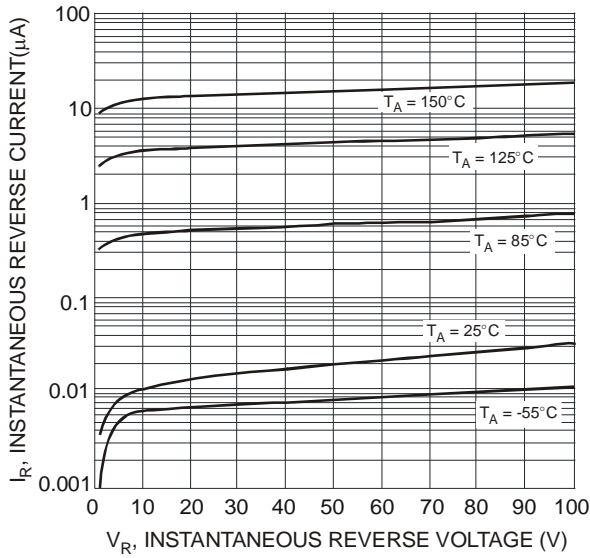

Fig. 3 Typical Reverse Characteristics

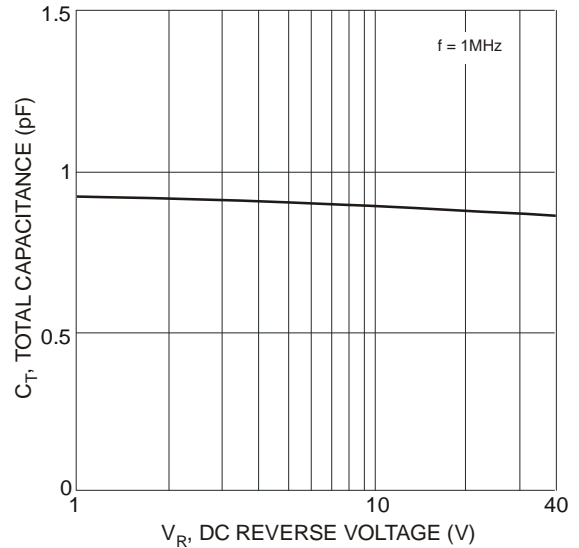
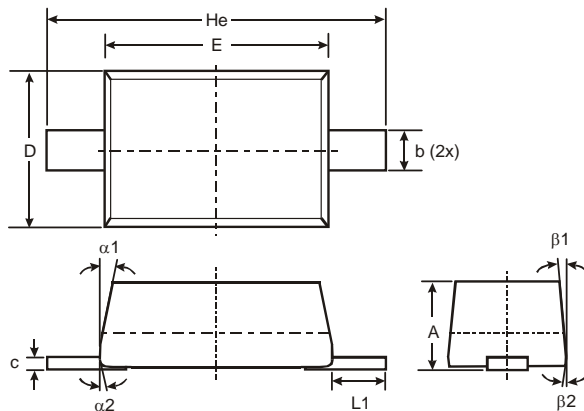

Fig. 4 Total Capacitance vs. Reverse Voltage

Package Outline Dimensions



SOD323F			
Dim	Min	Max	Typ
A	0.60	0.75	-
b	0.25	0.35	-
c	0.05	0.26	-
D	1.15	1.35	1.25
E	1.60	1.80	1.70
He	2.30	2.70	2.50
L1	0.30	0.50	0.40
α1	-	-	7°
α2	-	-	3°
β1	-	-	7°
β2	-	-	3°

All Dimensions in mm

Suggested Pad Layout

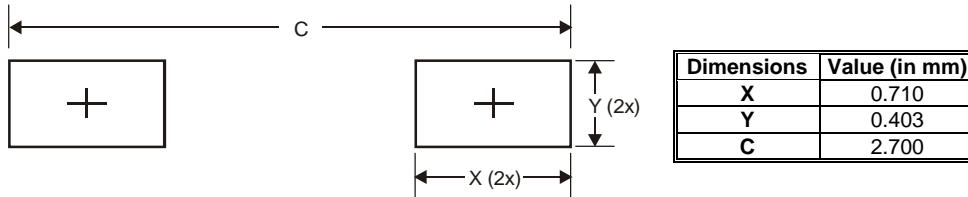

IMPORTANT NOTICE

DIODES INCORPORATED MAKES NO WARRANTY OF ANY KIND, EXPRESS OR IMPLIED, WITH REGARDS TO THIS DOCUMENT, INCLUDING, BUT NOT LIMITED TO, THE IMPLIED WARRANTIES OF MERCHANTABILITY AND FITNESS FOR A PARTICULAR PURPOSE (AND THEIR EQUIVALENTS UNDER THE LAWS OF ANY JURISDICTION).

Diodes Incorporated and its subsidiaries reserve the right to make modifications, enhancements, improvements, corrections or other changes without further notice to this document and any product described herein. Diodes Incorporated does not assume any liability arising out of the application or use of this document or any product described herein; neither does Diodes Incorporated convey any license under its patent or trademark rights, nor the rights of others. Any Customer or user of this document or products described herein in such applications shall assume all risks of such use and will agree to hold Diodes Incorporated and all the companies whose products are represented on Diodes Incorporated website, harmless against all damages.

Diodes Incorporated does not warrant or accept any liability whatsoever in respect of any products purchased through unauthorized sales channel. Should Customers purchase or use Diodes Incorporated products for any unintended or unauthorized application, Customers shall indemnify and hold Diodes Incorporated and its representatives harmless against all claims, damages, expenses, and attorney fees arising out of, directly or indirectly, any claim of personal injury or death associated with such unintended or unauthorized application.

Products described herein may be covered by one or more United States, international or foreign patents pending. Product names and markings noted herein may also be covered by one or more United States, international or foreign trademarks.

LIFE SUPPORT

Diodes Incorporated products are specifically not authorized for use as critical components in life support devices or systems without the express written approval of the Chief Executive Officer of Diodes Incorporated. As used herein:

- A. Life support devices or systems are devices or systems which:
 - 1. are intended to implant into the body, or
 - 2. support or sustain life and whose failure to perform when properly used in accordance with instructions for use provided in the labeling can be reasonably expected to result in significant injury to the user.
- B. A critical component is any component in a life support device or system whose failure to perform can be reasonably expected to cause the failure of the life support device or to affect its safety or effectiveness.

Customers represent that they have all necessary expertise in the safety and regulatory ramifications of their life support devices or systems, and acknowledge and agree that they are solely responsible for all legal, regulatory and safety-related requirements concerning their products and any use of Diodes Incorporated products in such safety-critical, life support devices or systems, notwithstanding any devices- or systems-related information or support that may be provided by Diodes Incorporated. Further, Customers must fully indemnify Diodes Incorporated and its representatives against any damages arising out of the use of Diodes Incorporated products in such safety-critical, life support devices or systems.

Copyright © 2011, Diodes Incorporated

www.diodes.com