

HF  5KP Automotive Series

Agency Approvals

AGENCY	AGENCY FILE NUMBER
	E128662/E230531

**Maximum Ratings and Thermal Characteristics
(T_A=25°C unless otherwise noted)**

Parameter	Symbol	Value	Unit
Peak Pulse Power Dissipation by 10x1000µs test waveform (Fig.1) (Note 1)	P _{PPM}	5000	W
Steady State Power Dissipation on infinite heat sink at T _L =75°C (Fig. 5)	P _D	8.0	W
Peak Forward Surge Current, 8.3ms Single Half Sine Wave Unidirectional only (Note 2)	I _{FSM}	400	A
Maximum Instantaneous Forward Voltage at 100A for Unidirectional only.	V _F	3.5	V
Operating Junction and Storage Temperature Range	T _J , T _{STG}	-55 to 175	°C
Typical Thermal Resistance Junction to Lead	R _{θJL}	8.0	°C/W
Typical Thermal Resistance Junction to Ambient	R _{θJA}	40	°C/W

Notes:

1. Non-repetitive current pulse, per Fig. 3 and derated above T_A = 25°C per Fig. 2.
2. Measured on 8.3ms single half sine wave or equivalent square wave, duty cycle=4 per minute maximum.

Description

The 5KP Automotive Series is designed specifically to protect sensitive electronic equipment from voltage transients induced by lightning and other transient voltage events.

Features

- Halogen-Free
- RoHS compliant
- Typical maximum temperature coefficient
 $\Delta V_{BR} = 0.1\% \times V_{BR} @ 25^{\circ}\text{C} \times \Delta T$
- Glass passivated chip junction in P600 package
- 5000W peak pulse capability at 10x1000µs waveform, repetition rate (duty cycles):0.01%
- Fast response time: typically less than 1.0ps from 0 Volts to BV min
- Excellent clamping capability
- Low incremental surge resistance
- Typical I_R less than 2µA above 12V
- High temperature soldering guaranteed: 260°C/40 seconds / 0.375", (9.5mm) lead length, 5 lbs., (2.3kg) tension
- Plastic package has Underwriters Laboratory Flammability classification 94V-O
- Matte Tin Lead-free plated

Applications

TVS devices are ideal for the protection of I/O interfaces, V_{CC} bus and other vulnerable circuits used in telecom, computer, industrial and consumer electronic applications.

Electrical Characteristics

Part Number (Uni)	Part Number (Bi)	Reverse Stand off Voltage V_R (Volts)	Breakdown Voltage V_{BR} (Volts) @ I_T		Test Current I_T (mA)	Maximum Clamping Voltage V_C @ I_{PP} (V)	Maximum Peak Pulse Current I_{PP} (A)	Maximum Reverse Leakage I_R @ V_R (μ A)	Agency Approval 
			MIN	MAX					
5KP12AAUTO	5KP12CAAUTO	12.0	13.30	14.70	5	19.9	256.3	2	X
5KP13AAUTO	5KP13CAAUTO	13.0	14.40	15.90	5	21.5	237.2	2	X
5KP14AAUTO	5KP14CAAUTO	14.0	15.60	17.20	5	23.2	219.8	2	X
5KP15AAUTO	5KP15CAAUTO	15.0	16.70	18.50	5	24.4	209.0	2	X
5KP16AAUTO	5KP16CAAUTO	16.0	17.80	19.70	5	26.0	196.2	2	X
5KP17AAUTO	5KP17CAAUTO	17.0	18.90	20.90	5	27.6	184.8	2	X
5KP18AAUTO	5KP18CAAUTO	18.0	20.00	22.10	5	29.2	174.7	2	X
5KP20AAUTO	5KP20CAAUTO	20.0	22.20	24.50	5	32.4	157.4	2	X
5KP22AAUTO	5KP22CAAUTO	22.0	24.00	26.90	5	35.5	143.7	2	X
5KP24AAUTO	5KP24CAAUTO	24.0	26.70	29.50	5	38.9	131.1	2	X
5KP26AAUTO	5KP26CAAUTO	26.0	28.90	31.90	5	42.1	121.1	2	X
5KP28AAUTO	5KP28CAAUTO	28.0	31.10	34.40	5	45.4	112.3	2	X
5KP30AAUTO	5KP30CAAUTO	30.0	33.30	36.80	5	48.4	105.4	2	X
5KP33AAUTO	5KP33CAAUTO	33.0	36.70	40.60	5	53.3	95.7	2	X
5KP36AAUTO	5KP36CAAUTO	36.0	40.00	44.20	5	58.1	87.8	2	X
5KP40AAUTO	5KP40CAAUTO	40.0	44.40	49.10	5	64.5	79.1	2	X

For parts without A, the V_{BR} is $\pm 10\%$ and V_C is 5% higher than with A parts

Ratings and Characteristic Curves ($T_A=25^\circ\text{C}$ unless otherwise noted)

Figure 1 - Peak Pulse Power Rating Curve

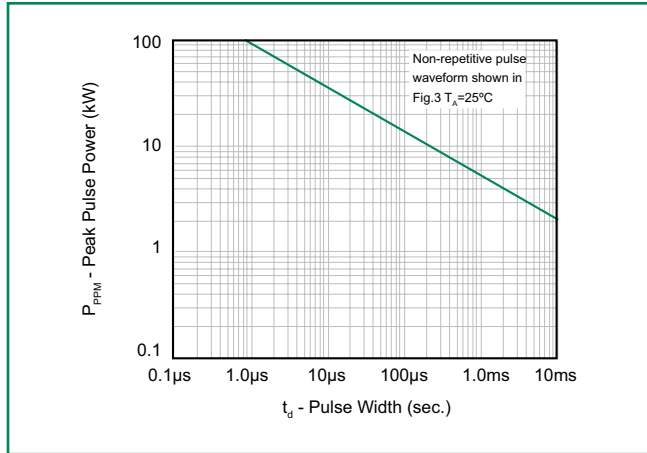

Figure 2 - Pulse Derating Curve

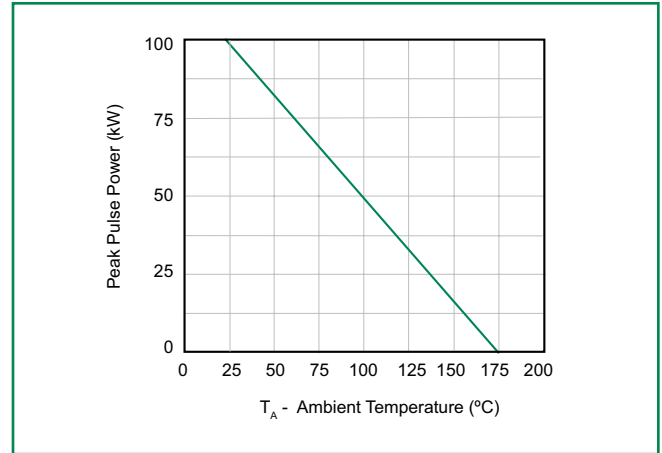

Figure 3 - Pulse Waveform

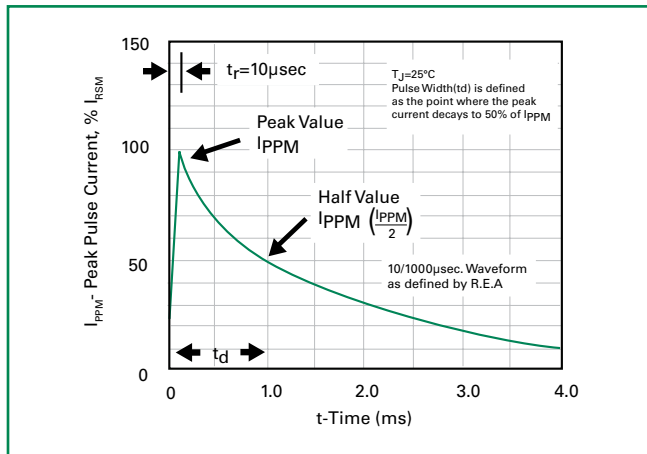

Figure 4 - Typical Junction Capacitance

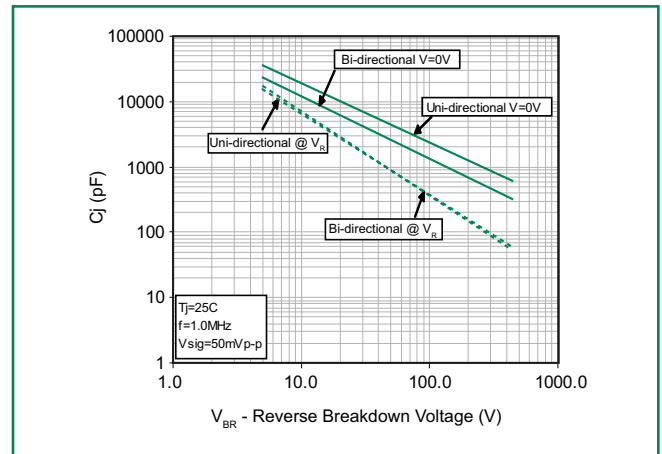

Figure 5 - Steady State Power Derating Curve

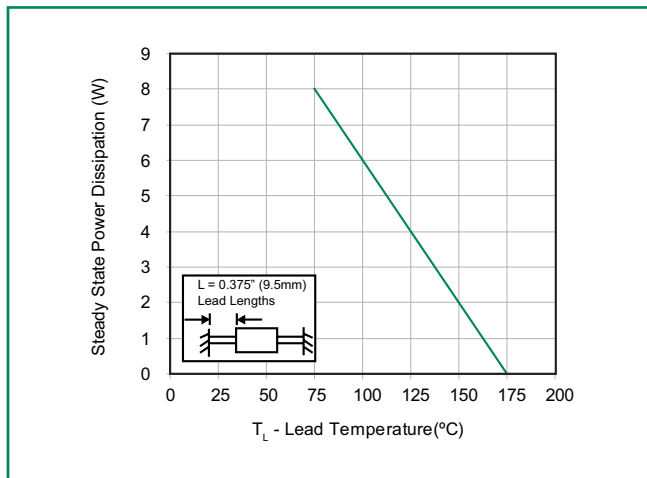
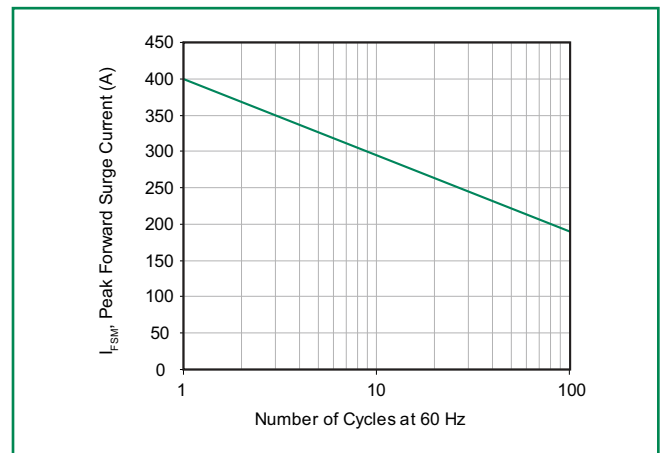

Figure 6 - Maximum Non-Repetitive Peak Forward Surge Current



5KP Automotive Series

Soldering Parameters

Reflow Condition		Lead-free assembly
Pre Heat	- Temperature Min ($T_{s(min)}$)	150°C
	- Temperature Max ($T_{s(max)}$)	200°C
	- Time (min to max) (t_s)	60 – 180 secs
Average ramp up rate (Liquidus Temp (T_L) to peak)		3°C/second max
$T_{s(max)}$ to T_L - Ramp-up Rate		3°C/second max
Reflow	- Temperature (T_L) (Liquidus)	217°C
	- Time (min to max) (t_s)	60 – 150 seconds
Peak Temperature (T_p)		260 ^{+0/-5} °C
Time within 5°C of actual peak Temperature (t_p)		20 – 40 seconds
Ramp-down Rate		6°C/second max
Time 25°C to peak Temperature (T_p)		8 minutes Max.
Do not exceed		280°C

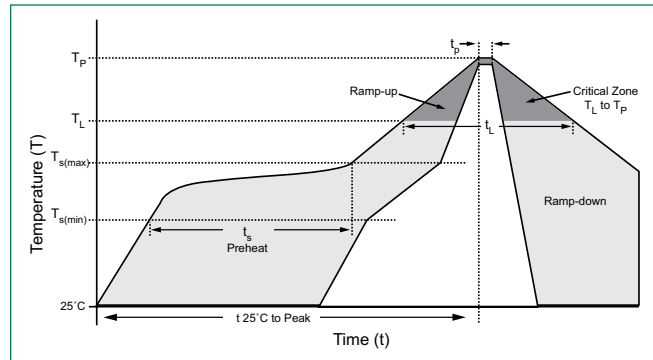

Flow/Wave Soldering (Solder Dipping)

Peak Temperature :	265°C
Dipping Time :	10 seconds
Soldering :	1 time

Physical Specifications

Weight	0.07oz., 2.1g
Case	P600 molded plastic body over passivated junction.
Polarity	Color band denotes the cathode except Bipolar.
Terminal	Matte Tin axial leads, solderable per JESD22-B102D.

Environmental Specifications

Temperature Cycle	JESD22-A104
Pressure Cooker	JESD 22-A102
High Temp. Storage	JESD22-A103
HTRB	JESD22-A108
Thermal Shock	JESD22-A106

Dimensions

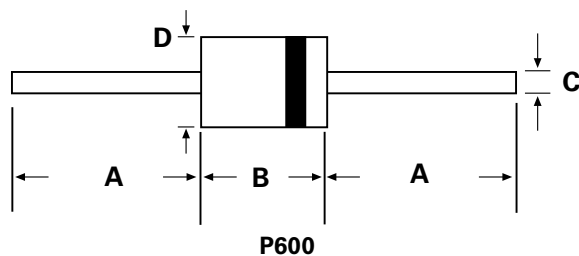

Dimensions	Inches		Millimeters	
	Min	Max	Min	Max
A	1.000	-	25.40	-
B	0.340	0.360	8.60	9.10
C	0.048	0.052	1.22	1.32
D	0.340	0.360	8.60	9.10

Part Numbering System

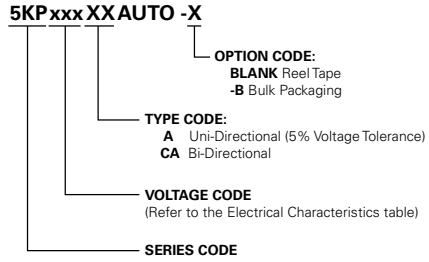

Part Marking System

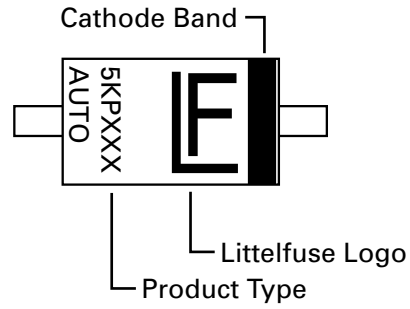

Packaging

Part Number	Component Package	Quantity	Packaging Option	Packaging Specification
5KPxxxXXAUTO	P600	800	Tape & Reel	EIA STD RS-296E
5KPxxxXXAUTO-B	P600	500	BULK	Littelfuse Concord Packing Spec. DM-0016

