

Features

- Fast Switching
- Ultra-Small Surface Mount Package
- PN Junction Guard Ring for Transient and ESD Protection
- Available in Lead Free/RoHS Compliant Version (Note 3)

Mechanical Data

- Case: SOD-323
- Case Material: Molded Plastic. UL Flammability Classification Rating 94V-0
- Moisture Sensitivity: Level 1 per J-STD-020C
- Leads: Solderable per MIL-STD-202, Method 208
- Also Available in Lead Free Plating (Matte Tin Finish annealed over Alloy 42 leadframe). Please See Ordering Information, Note 6, on Page 3
- Polarity: Cathode Band
- Marking: See Page 3
- Type Code: L9
- Weight: 0.004 grams (approximate)

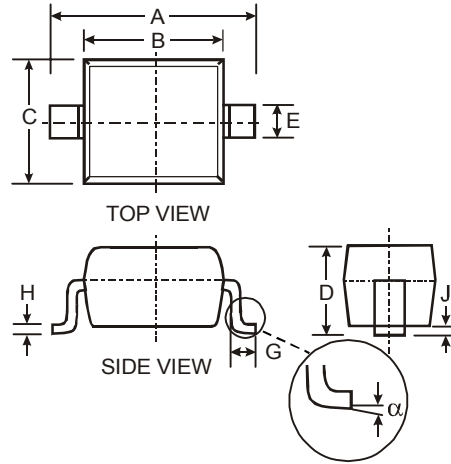

SOD-323		
Dim	Min	Max
A	2.30	2.70
B	1.60	1.80
C	1.20	1.40
D	1.05 Typical	
E	0.25	0.35
G	0.20	0.40
H	0.10	0.15
J	0.05 Typical	
α	0°	8°
All Dimensions in mm		

Maximum Ratings @T_A = 25°C unless otherwise specified

Characteristic	Symbol	Value	Unit
Peak Repetitive Reverse Voltage	V _{RRM}	30	V
Working Peak Reverse Voltage	V _{RWM}		
DC Blocking Voltage	V _R		
RMS Reverse Voltage	V _{R(RMS)}	21	V
Average Rectified Forward Current	I _O	100	mA
Forward Continuous Current (Note 1)	I _F	200	mA
Repetitive Peak Forward Current (Note 1)	I _{FRM}	300	mA
Forward Surge Current (Note 1) @ t < 1.0s	I _{FSM}	600	mA
Power Dissipation (Note 1)	P _d	200	mW
Thermal Resistance, Junction to Ambient Air (Note 1)	R _{θJA}	625	°C/W
Operating and Storage Temperature Range (Note 4)	T _j , T _{STG}	-65 to +150	°C

Electrical Characteristics @T_A = 25°C unless otherwise specified

Characteristic	Symbol	Min	Typ	Max	Unit	Test Condition
Reverse Breakdown Voltage (Note 2)	V _{(BR)R}	30	—	—	V	I _R = 100μA
Forward Voltage	V _{FM}	—	—	240	mV	I _F = 0.1mA
				320		I _F = 1mA
				400		I _F = 10mA
				500		I _F = 30mA
				1000		I _F = 100mA
Reverse Leakage Current (Note 2)	I _{RM}	—	—	2.0	μA	V _R = 25V
Total Capacitance	C _T	—	—	10	pF	V _R = 1.0V, f = 1.0MHz
Reverse Recovery Time	t _{rr}	—	—	5.0	ns	I _F = 10mA through I _R = 10mA to I _R = 1.0mA, R _L = 100Ω

- Notes:
1. Part mounted on FR-4 PC board with recommended pad layout, which can be found on our website at <http://www.diodes.com/datasheets/ap02001.pdf>.
 2. Short duration pulse test used to minimize self-heating effect.
 3. No purposefully added lead.
 4. $\frac{dP_{tot}}{dT_j} > \frac{1}{R_{th(j-a)}}$ thermal runaway condition for a diode on its own heatsink.

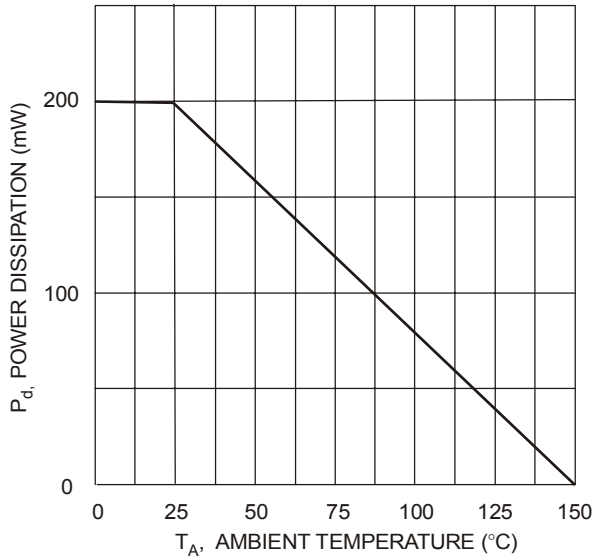

Fig. 1 Power Derating Curve

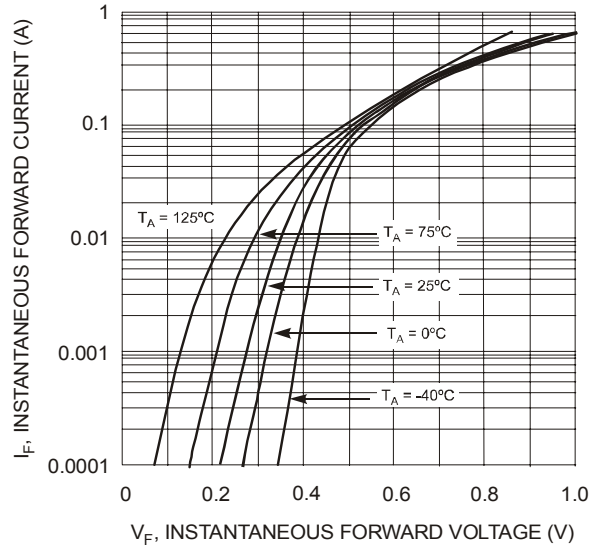

Fig. 2 Forward Characteristics

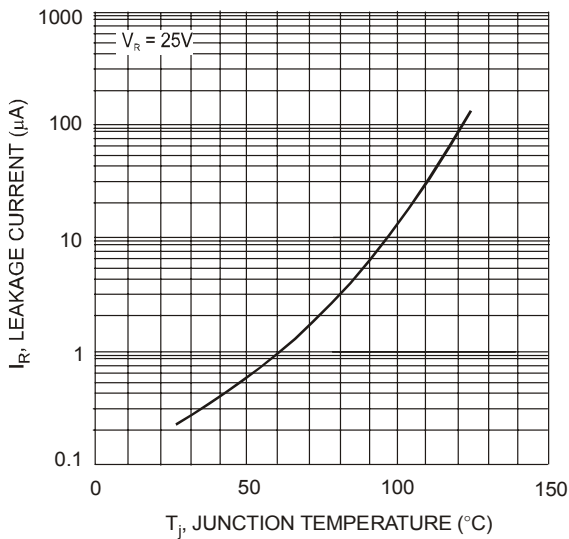

Fig. 3 Typical Reverse Characteristics

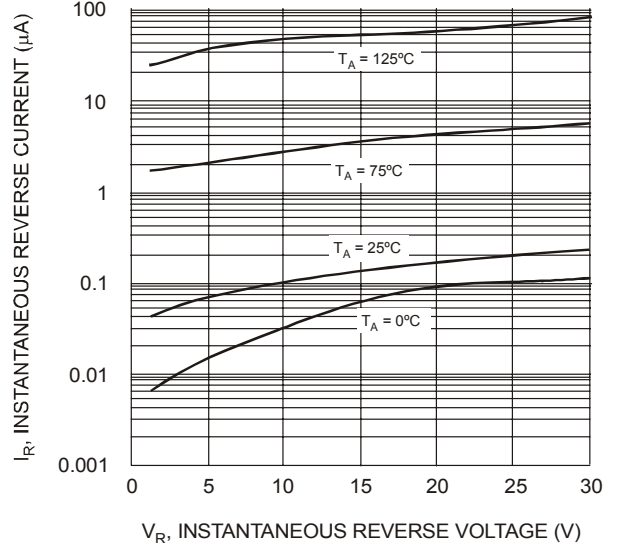

Fig. 4 Typical Reverse Characteristics

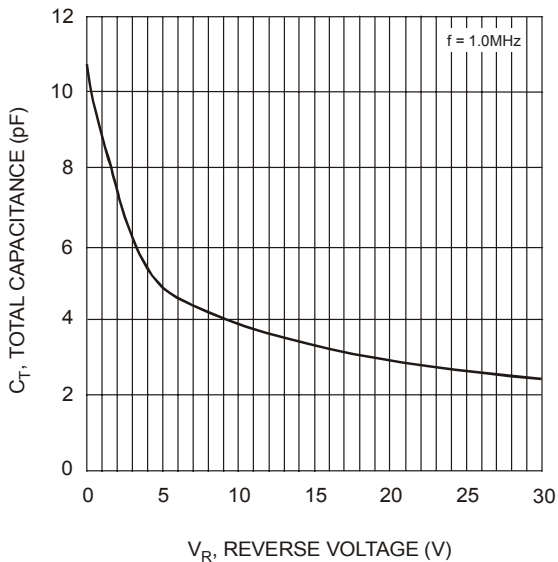

Fig. 5 Typical Capacitance vs. Reverse Voltage

Ordering Information (Note 5)

Device	Packaging	Shipping
BAT54WS-7	SOD-323	3000/Tape & Reel
BAT54WS-7-F (Note 6)	SOD-323	3000/Tape & Reel

Notes: 5. For Packaging Details, go to our website at: <http://www.diodes.com/datasheets/ap02007.pdf>.
6. For Lead Free/RoHS Compliant version part number, please add "-F" suffix to the part number above. Example: BAT54WS-7-F.

Marking Information

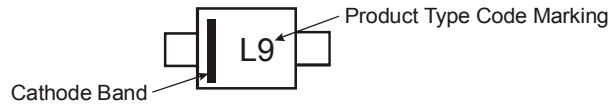

IMPORTANT NOTICE

Diodes Incorporated and its subsidiaries reserve the right to make modifications, enhancements, improvements, corrections or other changes without further notice to any product herein. Diodes Incorporated does not assume any liability arising out of the application or use of any product described herein; neither does it convey any license under its patent rights, nor the rights of others. The user of products in such applications shall assume all risks of such use and will agree to hold Diodes Incorporated and all the companies whose products are represented on our website, harmless against all damages.

LIFE SUPPORT

Diodes Incorporated products are not authorized for use as critical components in life support devices or systems without the expressed written approval of the President of Diodes Incorporated.