

Molded Radials

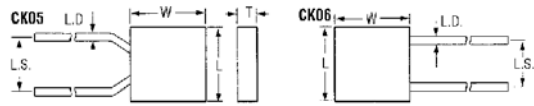

Case Size

Style	Length L	Width W	Thickness T	Lead Spacing LS	Lead Dia. LD
CK05	4.83 ±.25 (.190 ±.010)	4.83 ±.25 (.190 ±.010)	2.29 ±.25 (.090 ±.010)	5.08 ±.38 (.200 ±.015)	.64 ±.05 (.025 ±.002)
CK06	7.37 ±.25 (.290 ±.010)	7.37 ±.25 (.290 ±.010)	2.29 ±.25 (.090 ±.010)	5.08 ±.38 (.200 ±.015)	.64 ±.05 (.025 ±.002)

Stock No.	Mfr.'s Type	Cap. pF	Voltage	Tol.	EACH				Stock No.	Mfr.'s Type	Cap. pF	Voltage	Tol.	EACH			
					1-24	25-49	50-99	100-499						1-24	25-49	50-99	100-499
881-5424	CK05BX123K	12000	50	10	.68	.37	.29	.21	881-5482	CK05BX270K	27	200	10	.56	.37	.31	.25
881-5426	CK05BX153K	15000	50	10	.57	.39	.32	.25	881-5484	CK05BX330K	33	200	10	.56	.37	.31	.25
881-5428	CK05BX183K	18000	50	10	.57	.39	.32	.25	881-5488	CK05BX470K	47	200	10	.56	.37	.31	.25
881-5430	CK05BX223K	22000	50	10	.63	.34	.27	.20	881-5490	CK05BX560K	56	200	10	.46	.25	.19	.15
881-5432	CK05BX273K	27000	50	10	.74	.50	.41	.33	881-5492	CK05BX680K	68	200	10	.56	.37	.31	.25
881-5434	CK05BX333K	33000	50	10	.59	.40	.33	.27	881-5494	CK05BX820K	82	200	10	1.00	.67	.55	.45
881-5438	CK05BX473K	47000	50	10	.64	.36	.28	.20	881-5496	CK05BX101K	100	200	10	.56	.37	.31	.25
881-5440	CK05BX563K	56000	50	10	.68	.45	.39	.31	881-5498	CK05BX121K	120	200	10	.56	.37	.31	.25
881-5442	CK05BX683K	68000	50	10	.68	.45	.39	.31	881-5500	CK05BX151K	150	200	10	.56	.37	.31	.25
881-5446	CK05BX104K	100000	50	10	.54	.37	.31	.25	881-5504	CK05BX221K	220	200	10	.56	.37	.31	.25
881-5450	CK05BX152K	1500	100	10	.56	.37	.31	.25	881-5508	CK05BX331K	330	200	10	.61	.41	.34	.28
881-5452	CK05BX182K	1800	100	10	.56	.37	.31	.25	881-5510	CK05BX391K	390	200	10	.73	.49	.40	.33
881-5454	CK05BX222K	2200	100	10	.46	.25	.19	.15	881-5512	CK05BX471K	470	200	10	.61	.41	.34	.28
881-5456	CK05BX272K	2700	100	10	.56	.37	.31	.25	881-5518	CK05BX821K	820	200	10	.56	.37	.31	.25
881-5458	CK05BX332K	3300	100	10	.56	.37	.31	.25	881-5520	CK05BX102K	1000	200	10	.56	.37	.31	.25
881-5460	CK05BX392K	3900	100	10	.56	.37	.31	.25	881-5524	CK06BX154K	150000	50	10	1.25	.86	.69	.57
881-5462	CK05BX472K	4700	100	10	.46	.25	.19	.15	881-5528	CK06BX224K	220000	50	10	1.09	.75	.61	.49
881-5464	CK05BX562K	5600	100	10	.79	.53	.44	.36	881-5530	CK06BX274K	270000	50	10	1.96	1.34	1.09	.88
881-5466	CK05BX682K	6800	100	10	.56	.39	.32	.25	881-5532	CK06BX334K	330000	50	10	1.96	1.34	1.09	.88
881-5468	CK05BX822K	8200	100	10	1.01	.69	.57	.46	881-5536	CK06BX474K	470000	50	10	2.45	1.66	1.36	1.11
881-5470	CK05BX103K	10000	100	10	.61	.42	.35	.27	881-5540	CK06BX684K	680000	50	10	3.26	2.22	1.80	1.49
881-5472	CK05BX100K	10	200	10	.56	.37	.31	.25	881-5544	CK06BX105K	1000000	50	10	3.26	2.22	1.80	1.49
881-5474	CK05BX120K	12	200	10	.56	.37	.31	.25	881-5552	CK06BX223K	220000	100	10	.65	.43	.35	.29
881-5476	CK05BX150K	15	200	10	1.00	.67	.55	.45	881-5564	CK06BX683K	680000	100	10	.79	.54	.44	.36
881-5478	CK05BX180K	18	200	10	1.00	.67	.56	.46	881-5568	CK06BX104K	1000000	100	10	.71	.39	.29	.23
881-5480	CK05BX220K	22	200	10	.56	.37	.31	.25	881-5592	CK06BX103K	100000	200	10	.62	.42	.34	.28

Ceramic Radial Dipguard

Stock No.	Mfr.'s Type	Cap. pF	Voltage	Tol.	Temp. Coefficient	EACH		
						1-99	100-499	500-Up
881-5624	MD015A100KAB	10	50	10	NPO	.40	.29	.25
881-5626	MD015A150KAB	15	50	10	NPO	.40	.29	.25
881-5636	MD015A101KAB	100	50	10	NPO	.40	.29	.25
881-5640	MD015A221KAB	220	50	10	NPO	.40	.29	.25
881-5642	MD015A331KAB	330	50	10	NPO	.40	.29	.25
881-5648	MD015A102KAB	1000	50	10	NPO	.43	.31	.28
881-5650	MD015A152KAB	1500	50	10	NPO	.51	.37	.32
881-5652	MD015A222KAB	2200	50	10	NPO	.51	.37	.32
881-5654	MD015A332KAB	3300	50	10	NPO	.77	.57	.49
881-5656	MD025A103KAB	10000	50	10	NPO	1.75	1.30	1.11
881-5662	MD015C471KAB	471	50	10	X7R	.43	.31	.28
881-5666	MD015C102KAB	1000	50	10	X7R	.43	.31	.28
881-5672	MD015C332KAB	3300	50	10	X7R	.43	.31	.28
881-5674	MD015C472KAB	4700	50	10	X7R	.43	.31	.28
881-5680	MD015C223KAB	22000	50	10	X7R	.51	.37	.32
881-5684	MD015C473KAB	47000	50	10	X7R	.51	.37	.32
881-5688	MD015C104KAB	100000	50	10	X7R	.43	.31	.28
881-5690	MD025C154KAB	150000	50	10	X7R	.69	.52	.44
881-5692	MD025C224KAB	220000	50	10	X7R	.69	.52	.44
881-5696	MD035C105KAA	1000000	50	10	X7R	5.82	4.40	3.71
881-5700	MD015E103ZAB	10000	50	+80-20%	Z5U	.33	.20	.16
881-5706	MD015E104ZAB	100000	50	+80-20%	Z5U	.33	.20	.16
881-5710	MD015E334ZAB	330000	50	+80-20%	Z5U	.51	.37	.34
881-5714	MD035E105ZAA	1000000	50	+80-20%	Z5U	1.44	1.06	.91

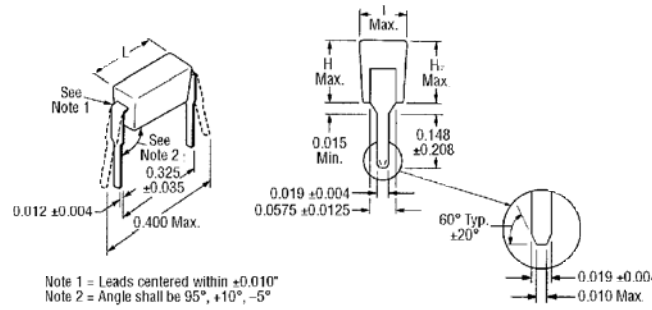

Size Specifications — mm (In.)

Style	Length L	Height H ₁	Height H ₂	Thickness T
MDO1	6.60 (.260 ±.020)	3.43 (.135 max.)	4.19 (.165 max.)	2.54 (.098 max.)
MD02	6.60 (.260 ±.020)	4.19 (.162 max.)	5.08 (.195 max.)	2.54 (.098 max.)
MD03	6.60 (.260 ±.020)	7.37 (.290 max.)	8.13 (.320 max.)	2.54 (.098 max.)