



Device Overview

The 89HPES24N3A is a member of the IDT PRECISE™ family of PCI Express® switching solutions. The PES24N3A is a 24-lane, 3-port peripheral chip that performs PCI Express packet switching with a feature set optimized for high performance applications such as servers, storage, and communications/networking. It provides connectivity and switching functions between a PCI Express upstream port and two downstream ports and supports switching between downstream ports.

Features

- ◆ **High Performance PCI Express Switch**
 - Twenty-four 2.5 Gbps PCI Express lanes
 - Three switch ports
 - Upstream port configurable up to x8
 - Downstream ports configurable up to x8
 - Low-latency cut-through switch architecture
 - Support for Max Payload Size up to 2048 bytes
 - One virtual channel
 - Eight traffic classes
 - PCI Express Base Specification Revision 1.1 compliant
- ◆ **Flexible Architecture with Numerous Configuration Options**
 - Automatic per port link width negotiation to x8, x4, x2 or x1
 - Automatic lane reversal on all ports
 - Automatic polarity inversion on all lanes
 - Ability to load device configuration from serial EEPROM
- ◆ **Legacy Support**
 - PCI compatible INTx emulation
 - Bus locking
- ◆ **Highly Integrated Solution**
 - Requires no external components
 - Incorporates on-chip internal memory for packet buffering and queuing
 - Integrates twenty-four 2.5 Gbps embedded SerDes with 8B/10B encoder/decoder (no separate transceivers needed)
- ◆ **Reliability, Availability, and Serviceability (RAS) Features**
 - Supports ECRC and Advanced Error Reporting
 - Internal end-to-end parity protection on all TLPs ensures data integrity even in systems that do not implement end-to-end CRC (ECRC)
 - Supports PCI Express Native Hot-Plug, Hot-Swap capable I/O
 - Compatible with Hot-Plug I/O expanders used on PC and server motherboards

Block Diagram

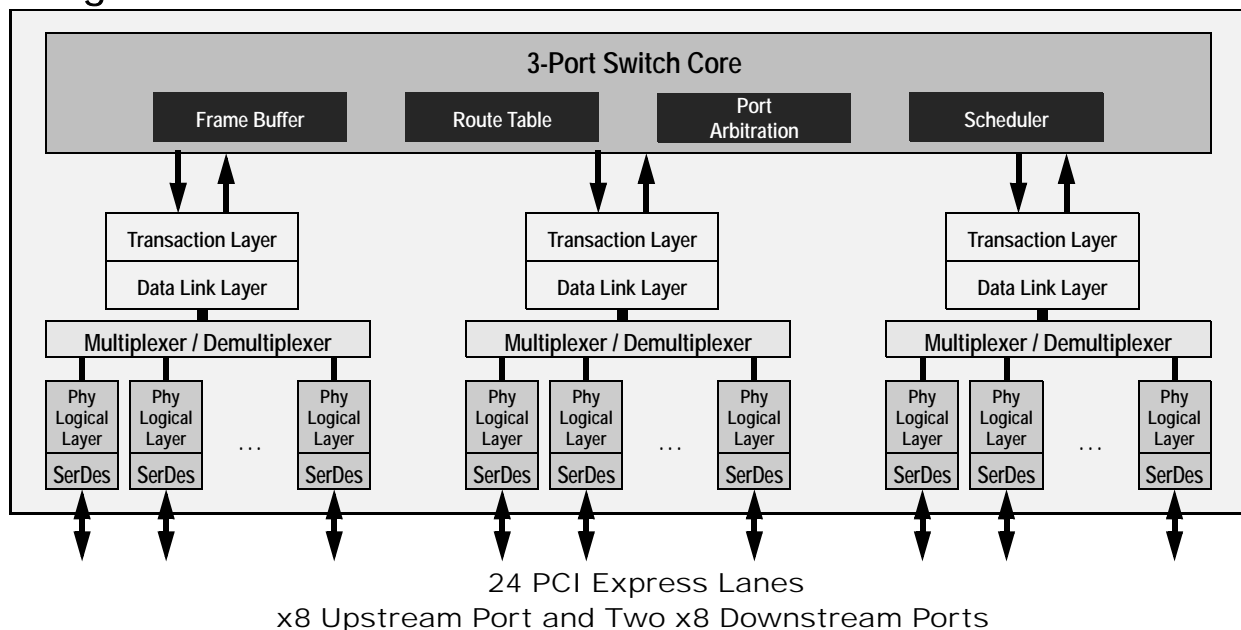

Figure 1 Internal Block Diagram

- ◆ **Power Management**
 - Utilizes advanced low-power design techniques to achieve low typical power consumption
 - Supports PCI Power Management Interface specification (PCI-PM 1.1)
 - Supports device power management states: D0, D3_{hot} and D3_{cold}
 - Unused SerDes are disabled
- ◆ **Testability and Debug Features**
 - Ability to read and write any internal register via the SMBus
- ◆ **Eight General Purpose Input/Output Pins**
 - Each pin may be individually configured as an input or output
 - Each pin may be individually configured as an interrupt input
 - Some pins have selectable alternate functions
- ◆ **Packaged in 27x27mm 420 ball BGA with 1mm ball spacing**

Product Description

Utilizing standard PCI Express interconnect, the PES24N3A provides the most efficient I/O connectivity solution for applications requiring high throughput, low latency, and simple board layout with a minimum number of board layers. It provides connectivity for up to 3 ports across 24 integrated serial lanes. Each lane provides 2.5 Gbps of bandwidth in both directions and is fully compliant with PCI Express Base specification revision 1.1.

SMBus Interface

The PES24N3A contains two SMBus interfaces. The slave interface provides full access to the configuration registers in the PES24N3A, allowing every configuration register in the device to be read or written by an external agent. The master interface allows the default configuration register values of the PES24N3A to be overridden following a reset with values programmed in an external serial EEPROM. The master interface is also used by an external Hot-Plug I/O expander.

Six pins make up each of the two SMBus interfaces. These pins consist of an SMBus clock pin, an SMBus data pin, and 4 SMBus address pins. In the slave interface, these address pins allow the SMBus address to which the device responds to be configured. In the master interface, these address pins allow the SMBus address of the serial configuration EEPROM from which data is loaded to be configured. The SMBus address is set up on negation of PERSTN by sampling the corresponding address pins. When the pins are sampled, the resulting address is assigned as shown in Table 1.

| Bit | Slave SMBus Address | Master SMBus Address |
|-----|---------------------|----------------------|
| 1 | SSMBADDR[1] | MSMBADDR[1] |
| 2 | SSMBADDR[2] | MSMBADDR[2] |
| 3 | SSMBADDR[3] | MSMBADDR[3] |

Table 1 Master and Slave SMBus Address Assignment

| Bit | Slave SMBus Address | Master SMBus Address |
|-----|---------------------|----------------------|
| 4 | 0 | MSMBADDR[4] |
| 5 | SSMBADDR[5] | 1 |
| 6 | 1 | 0 |
| 7 | 1 | 1 |

Table 1 Master and Slave SMBus Address Assignment

As shown in Figure 2, the master and slave SMBuses may be used in a unified or split configuration. In the unified configuration, shown in Figure 2(a), the master and slave SMBuses are tied together and the PES24N3A acts both as a SMBus master as well as a SMBus slave on this bus. This requires that the SMBus master or processor that has access to PES24N3A registers supports SMBus arbitration. In some systems, this SMBus master interface may be implemented using general purpose I/O pins on a processor or micro controller, and may not support SMBus arbitration. To support these systems, the PES24N3A may be configured to operate in a split configuration as shown in Figure 2(b).

In the split configuration, the master and slave SMBuses operate as two independent buses and thus multi-master arbitration is never required. The PES24N3A supports reading and writing of the serial EEPROM on the master SMBus via the slave SMBus, allowing in system programming of the serial EEPROM.

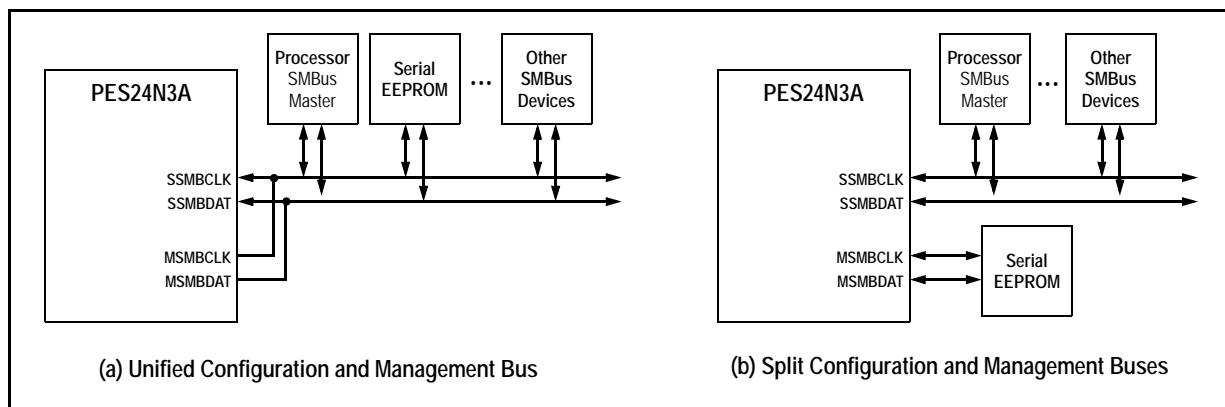

Figure 2 SMBus Interface Configuration Examples

Hot-Plug Interface

The PES24N3A supports PCI Express Hot-Plug on each downstream port. To reduce the number of pins required on the device, the PES24N3A utilizes an external I/O expander, such as that used on PC motherboards, connected to the SMBus master interface. Following reset and configuration, whenever the state of a Hot-Plug output needs to be modified, the PES24N3A generates an SMBus transaction to the I/O expander with the new value of all of the outputs. Whenever a Hot-Plug input changes, the I/O expander generates an interrupt which is received on the IOEXPINTN input pin (alternate function of GPIO) of the PES24N3A. In response to an I/O expander interrupt, the PES24N3A generates an SMBus transaction to read the state of all of the Hot-Plug inputs from the I/O expander.

General Purpose Input/Output

The PES24N3A provides eight General Purpose Input/Output (GPIO) pins that may be used by the system designer as bit I/O ports. Each GPIO pin may be configured independently as an input or output through software control. Some GPIO pins are shared with other on-chip functions. These alternate functions may be enabled via software, SMBus slave interface, or serial configuration EEPROM.

The PES24N3A is based on a flexible and efficient layered architecture. The PCI Express layer consists of SerDes, Physical, Data Link and Transaction layers in compliance with PCI Express Base specification Revision 1.1. The PES24N3A can operate either as a store and forward or cut-through switch and is designed to switch memory and I/O transactions. It supports eight Traffic Classes (TCs) and one Virtual Channel (VC) with sophisticated resource management to enable efficient switching and I/O connectivity for servers, storage, and embedded applications.

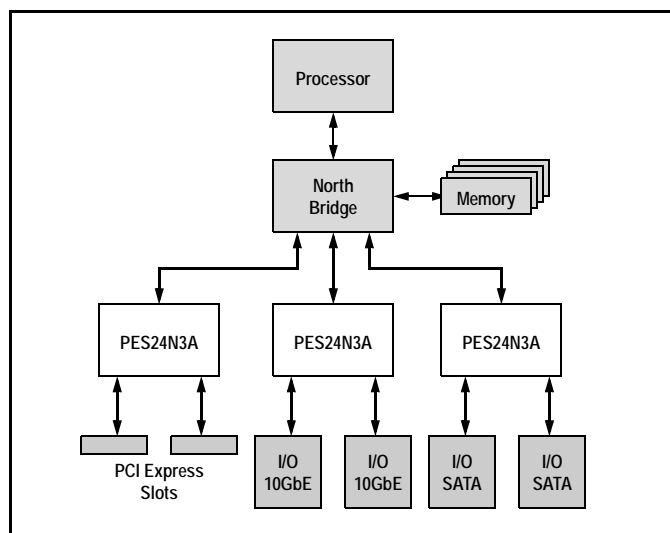

Figure 3 I/O Expansion Application

Pin Description

The following tables list the functions of the pins provided on the PES24N3A. Some of the functions listed may be multiplexed onto the same pin. The active polarity of a signal is defined using a suffix. Signals ending with an "N" are defined as being active, or asserted, when at a logic zero (low) level. All other signals (including clocks, buses, and select lines) will be interpreted as being active, or asserted, when at a logic one (high) level.

Note: In the PES24N3A, the two downstream ports are labeled port 2 and port 4.

| Signal | Type | Name/Description |
|----------------------------------|------|--|
| PE0RP[7:0] PE0RN[7:0] | I | PCI Express Port 0 Serial Data Receive. Differential PCI Express receive pairs for port 0. Port 0 is the upstream port. |
| PE0TP[7:0] PE0TN[7:0] | O | PCI Express Port 0 Serial Data Transmit. Differential PCI Express transmit pairs for port 0. Port 0 is the upstream port. |
| PE2RP[7:0] PE2RN[7:0] | I | PCI Express Port 2 Serial Data Receive. Differential PCI Express receive pairs for port 2. |
| PE2TP[7:0] PE2TN[7:0] | O | PCI Express Port 2 Serial Data Transmit. Differential PCI Express transmit pairs for port 2. |
| PE4RP[7:0] PE4RN[7:0] | I | PCI Express Port 4 Serial Data Receive. Differential PCI Express receive pairs for port 4. |
| PE4TP[7:0] PE4TN[7:0] | O | PCI Express Port 4 Serial Data Transmit. Differential PCI Express transmit pairs for port 4. |
| PEREFCLKP[2:1] PEREFCLKN[2:1] | I | PCI Express Reference Clock. Differential reference clock pair input. This clock is used as the reference clock by on-chip PLLs to generate the clocks required for the system logic and on-chip SerDes. The frequency of the differential reference clock is determined by the REFCLKM signal. |
| REFCLKM | I | PCI Express Reference Clock Mode Select. This signal selects the frequency of the reference clock input. 0x0 - 100 MHz 0x1 - 125 MHz |

Table 2 PCI Express Interface Pins

| Signal | Type | Name/Description |
|-----------------|------|--|
| MSMBADDR[4:1] | I | Master SMBus Address. These pins determine the SMBus address of the serial EEPROM from which configuration information is loaded. |
| MSMBCLK | I/O | Master SMBus Clock. This bidirectional signal is used to synchronize transfers on the master SMBus. It is active and generating the clock only when the EEPROM or I/O Expanders are being accessed. |
| MSMBDAT | I/O | Master SMBus Data. This bidirectional signal is used for data on the master SMBus. |
| SSMBADDR[5,3:1] | I | Slave SMBus Address. These pins determine the SMBus address to which the slave SMBus interface responds. |
| SSMBCLK | I/O | Slave SMBus Clock. This bidirectional signal is used to synchronize transfers on the slave SMBus. |
| SSMBDAT | I/O | Slave SMBus Data. This bidirectional signal is used for data on the slave SMBus. |

Table 3 SMBus Interface Pins

| Signal | Type | Name/Description |
|---------|------|---|
| GPIO[0] | I/O | General Purpose I/O. This pin can be configured as a general purpose I/O pin. Alternate function pin name: P2RSTN Alternate function pin type: Output Alternate function: Reset output for downstream port 2 |
| GPIO[1] | I/O | General Purpose I/O. This pin can be configured as a general purpose I/O pin. Alternate function pin name: P4RSTN Alternate function pin type: Output Alternate function: Reset output for downstream port 4 |
| GPIO[2] | I/O | General Purpose I/O. This pin can be configured as a general purpose I/O pin. Alternate function pin name: IOEXPINTN0 Alternate function pin type: Input Alternate function: I/O Expander interrupt 0 input |
| GPIO[3] | I/O | General Purpose I/O. This pin can be configured as a general purpose I/O pin. |
| GPIO[4] | I/O | General Purpose I/O. This pin can be configured as a general purpose I/O pin. Alternate function pin name: IOEXPINTN2 Alternate function pin type: Input Alternate function: I/O Expander interrupt 2 input |
| GPIO[5] | I/O | General Purpose I/O. This pin can be configured as a general purpose I/O pin. |
| GPIO[6] | I/O | General Purpose I/O. This pin can be configured as a general purpose I/O pin. |
| GPIO[7] | I/O | General Purpose I/O. This pin can be configured as a general purpose I/O pin. Alternate function pin name: GPEN Alternate function pin type: Output Alternate function: General Purpose Event (GPE) output |

Table 4 General Purpose I/O Pins

| Signal | Type | Name/Description |
|-----------|------|--|
| CCLKDS | I | Common Clock Downstream. When the CCLKDS pin is asserted, it indicates that a common clock is being used between the downstream device and the downstream port. |
| CCLKUS | I | Common Clock Upstream. When the CCLKUS pin is asserted, it indicates that a common clock is being used between the upstream device and the upstream port. |
| MSMBSMODE | I | Master SMBus Slow Mode. The assertion of this pin indicates that the master SMBus should operate at 100 KHz instead of 400 KHz. This value may not be overridden. |

Table 5 System Pins (Part 1 of 2)

| Signal | Type | Name/Description |
|-------------|------|--|
| PERSTN | I | Fundamental Reset. Assertion of this signal resets all logic inside PES24N3A and initiates a PCI Express fundamental reset. |
| RSTHALT | I | Reset Halt. When this signal is asserted during a PCI Express fundamental reset, PES24N3A executes the reset procedure and remains in a reset state with the Master and Slave SMBuses active. This allows software to read and write registers internal to the device before normal device operation begins. The device exits the reset state when the RSTHALT bit is cleared in the SWCTL register by an SMBus master. |
| SWMODE[3:0] | I | Switch Mode. These configuration pins determine the PES24N3A switch operating mode. 0x0 - Normal switch mode 0x1 - Normal switch mode with Serial EEPROM initialization 0x2 - through 0xF Reserved |

Table 5 System Pins (Part 2 of 2)

| Signal | Type | Name/Description |
|-------------|------|--|
| JTAG_TCK | I | JTAG Clock. This is an input test clock used to clock the shifting of data into or out of the boundary scan logic or JTAG Controller. JTAG_TCK is independent of the system clock with a nominal 50% duty cycle. |
| JTAG_TDI | I | JTAG Data Input. This is the serial data input to the boundary scan logic or JTAG Controller. |
| JTAG_TDO | O | JTAG Data Output. This is the serial data shifted out from the boundary scan logic or JTAG Controller. When no data is being shifted out, this signal is tri-stated. |
| JTAG_TMS | I | JTAG Mode. The value on this signal controls the test mode select of the boundary scan logic or JTAG Controller. |
| JTAG_TRST_N | I | JTAG Reset. This active low signal asynchronously resets the boundary scan logic and JTAG TAP Controller. An external pull-up on the board is recommended to meet the JTAG specification in cases where the tester can access this signal. However, for systems running in functional mode, one of the following should occur: 1) actively drive this signal low with control logic 2) statically drive this signal low with an external pull-down on the board |

Table 6 Test Pins

| Signal | Type | Name/Description |
|----------------------|------|--|
| V _{DD} CORE | I | Core V_{DD}. Power supply for core logic. |
| V _{DD} IO | I | I/O V_{DD}. LVTTTL I/O buffer power supply. |
| V _{DD} PE | I | PCI Express Digital Power. PCI Express digital power used by the digital power of the SerDes. |

Table 7 Power and Ground Pins

| Signal | Type | Name/Description |
|---------------------|------|--|
| V _{DD} APE | I | PCI Express Analog Power. PCI Express analog power used by the PLL and bias generator. |
| V _{TT} PE | I | PCI Express Termination Power. |
| V _{SS} | I | Ground. |

Table 7 Power and Ground Pins

Pin Characteristics

Note: Some input pads of the PES24N3A do not contain internal pull-ups or pull-downs. Unused inputs should be tied off to appropriate levels. This is especially critical for unused control signal inputs which, if left floating, could adversely affect operation. Also, any input pin left floating can cause a slight increase in power consumption.

| Function | Pin Name | Type | Buffer | I/O Type | Internal Resistor ¹ | Notes |
|-----------------------|-----------------|------|--------|------------------|--------------------------------|----------------------|
| PCI Express Interface | PE0RN[7:0] | I | CML | Serial link | | |
| | PE0RP[7:0] | I | | | | |
| | PE0TN[7:0] | O | | | | |
| | PE0TP[7:0] | O | | | | |
| | PE2RN[7:0] | I | | | | |
| | PE2RP[7:0] | I | | | | |
| | PE2TN[7:0] | O | | | | |
| | PE2TP[7:0] | O | | | | |
| | PE4RN[7:0] | I | | | | |
| | PE4RP[7:0] | I | | | | |
| | PE4TN[7:0] | O | | | | |
| | PE4TP[7:0] | O | | | | |
| | PEREFCLKN[2:1] | I | | | LVPECL/ CML | Diff. Clock Input |
| | PEREFCLKP[2:1] | I | | | | |
| | REFCLKM | I | LVTTTL | Input | pull-down | |
| SMBus | MSMBADDR[4:1] | I | LVTTTL | Input | pull-up | |
| | MSMBCLK | I/O | | STI ² | | pull-up on board |
| | MSMBDAT | I/O | | STI | | pull-up on board |
| | SSMBADDR[5,3:1] | I | | Input | pull-up | |
| | SSMBCLK | I/O | | STI | | pull-up on board |
| | SSMBDAT | I/O | | STI | | pull-up on board |
| General Purpose I/O | GPIO[7:0] | I/O | LVTTTL | High Drive | pull-up | |

Table 8 Pin Characteristics (Part 1 of 2)

| Function | Pin Name | Type | Buffer | I/O Type | Internal Resistor ¹ | Notes |
|--------------|-------------|------|--------|----------|--------------------------------|--------------------|
| System Pins | CCLKDS | I | LVTTTL | Input | pull-up | |
| | CCLKUS | I | | | pull-up | |
| | MSMBSMODE | I | | | pull-down | |
| | PERSTN | I | | | | |
| | RSTHALT | I | | | pull-down | |
| | SWMODE[3:0] | I | | | pull-down | |
| EJTAG / JTAG | JTAG_TCK | I | LVTTTL | STI | pull-up | |
| | JTAG_TDI | I | | STI | pull-up | |
| | JTAG_TDO | O | | | | |
| | JTAG_TMS | I | | STI | pull-up | |
| | JTAG_TRST_N | I | | STI | pull-up | External pull-down |

Table 8 Pin Characteristics (Part 2 of 2)

¹ Internal resistor values under typical operating conditions are 54K Ω for pull-up and 251K Ω for pull-down.

² Schmitt Trigger Input (STI).

Logic Diagram — PES24N3A

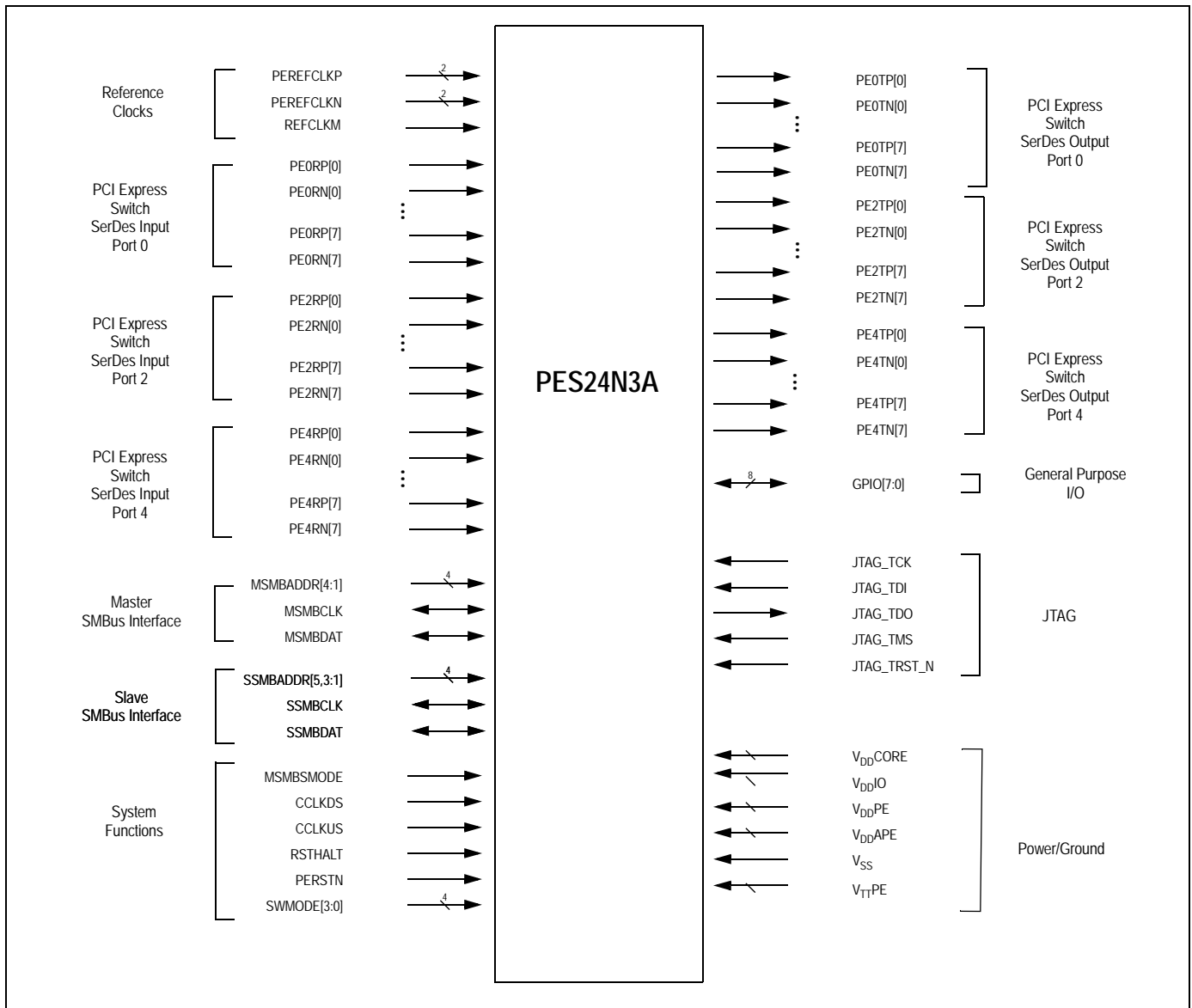

Figure 4 PES24N3A Logic Diagram

System Clock Parameters

Values based on systems running at recommended supply voltages and operating temperatures, as shown in Tables 13 and 14.

| Parameter | Description | Min | Typical | Max | Unit |
|-----------------------------------|---|-----|---------|------------------|-------------------|
| Refclk _{FREQ} | Input reference clock frequency range | 100 | | 125 ¹ | MHz |
| Refclk _{DC} ² | Duty cycle of input clock | 40 | 50 | 60 | % |
| T _R , T _F | Rise/Fall time of input clocks | | | 0.2*RCUI | RCUI ³ |
| V _{SW} | Differential input voltage swing ⁴ | 0.6 | | 1.6 | V |
| T _{jitter} | Input clock jitter (cycle-to-cycle) | | | 125 | ps |
| R _T | Termination Resistor | | 110 | | Ohms |

Table 9 Input Clock Requirements

¹ The input clock frequency will be either 100 or 125 MHz depending on signal REFCLKM.

² CLKIn must be AC coupled. Use 0.01 — 0.1 μF ceramic capacitors.

³ RCUI (Reference Clock Unit Interval) refers to the reference clock period.

⁴ AC coupling required.

AC Timing Characteristics

| Parameter | Description | Min ¹ | Typical ¹ | Max ¹ | Units |
|---|--|------------------|----------------------|------------------|-------|
| PCIe Transmit | | | | | |
| UI | Unit Interval | 399.88 | 400 | 400.12 | ps |
| T _{TX-EYE} | Minimum Tx Eye Width | 0.7 | .9 | | UI |
| T _{TX-EYE-MEDIAN-to-MAX-JITTER} | Maximum time between the jitter median and maximum deviation from the median | | | 0.15 | UI |
| T _{TX-RISE} , T _{TX-FALL} | D+ / D- Tx output rise/fall time | 50 | 90 | | ps |
| T _{TX-IDLE-MIN} | Minimum time in idle | 50 | | | UI |
| T _{TX-IDLE-SET-TO-IDLE} | Maximum time to transition to a valid Idle after sending an Idle ordered set | | | 20 | UI |
| T _{TX-IDLE-TO-DIFF-DATA} | Maximum time to transition from valid idle to diff data | | | 20 | UI |
| T _{TX-SKEW} | Transmitter data skew between any 2 lanes | | 500 | 1300 | ps |
| PCIe Receive | | | | | |
| UI | Unit Interval | 399.88 | 400 | 400.12 | ps |
| T _{RX-EYE (with jitter)} | Minimum Receiver Eye Width (jitter tolerance) | 0.4 | | | UI |

Table 10 PCIe AC Timing Characteristics (Part 1 of 2)

| Parameter | Description | Min ¹ | Typical ¹ | Max ¹ | Units |
|--|---|------------------|----------------------|------------------|-------|
| T _{RX-EYE-MEDIUM TO MAX JITTER} | Max time between jitter median & max deviation | | | 0.3 | UI |
| T _{RX-IDLE-DET-DIFF-ENTER TIME} | Unexpected Idle Enter Detect Threshold Integration Time | | | 10 | ms |
| T _{RX-SKEW} | Lane to lane input skew | | | 20 | ns |

Table 10 PCIe AC Timing Characteristics (Part 2 of 2)

¹: Minimum, Typical, and Maximum values meet the requirements under PCI Specification 1.1

| Signal | Symbol | Reference Edge | Min | Max | Unit | Timing Diagram Reference |
|------------------------|------------------------------|----------------|-----|-----|------|--------------------------|
| GPIO | | | | | | |
| GPIO[7:0] ¹ | T _{pw} ² | None | 50 | — | ns | |

Table 11 GPIO AC Timing Characteristics

¹: GPIO signals must meet the setup and hold times if they are synchronous or the minimum pulse width if they are asynchronous.

²: The values for this symbol were determined by calculation, not by testing.

| Signal | Symbol | Reference Edge | Min | Max | Unit | Timing Diagram Reference |
|----------------------------------|----------------------------------|------------------|------|------|------|--------------------------|
| JTAG | | | | | | |
| JTAG_TCK | T _{per_16a} | none | 50.0 | — | ns | See Figure 5. |
| | Thigh_16a, Tlow_16a | | 10.0 | 25.0 | ns | |
| JTAG_TMS ¹ , JTAG_TDI | T _{su_16b} | JTAG_TCK rising | 2.4 | — | ns | |
| | Thld_16b | | 1.0 | — | ns | |
| JTAG_TDO | T _{do_16c} | JTAG_TCK falling | — | 20 | ns | |
| | T _{dz_16c} ² | | — | 20 | ns | |
| JTAG_TRST_N | T _{pw_16d} ² | none | 25.0 | — | ns | |

Table 12 JTAG AC Timing Characteristics

¹: The JTAG specification, IEEE 1149.1, recommends that JTAG_TMS should be held at 1 while the signal applied at JTAG_TRST_N changes from 0 to 1. Otherwise, a race may occur if JTAG_TRST_N is deasserted (going from low to high) on a rising edge of JTAG_TCK when JTAG_TMS is low, because the TAP controller might go to either the Run-Test/Idle state or stay in the Test-Logic-Reset state.

²: The values for this symbol were determined by calculation, not by testing.

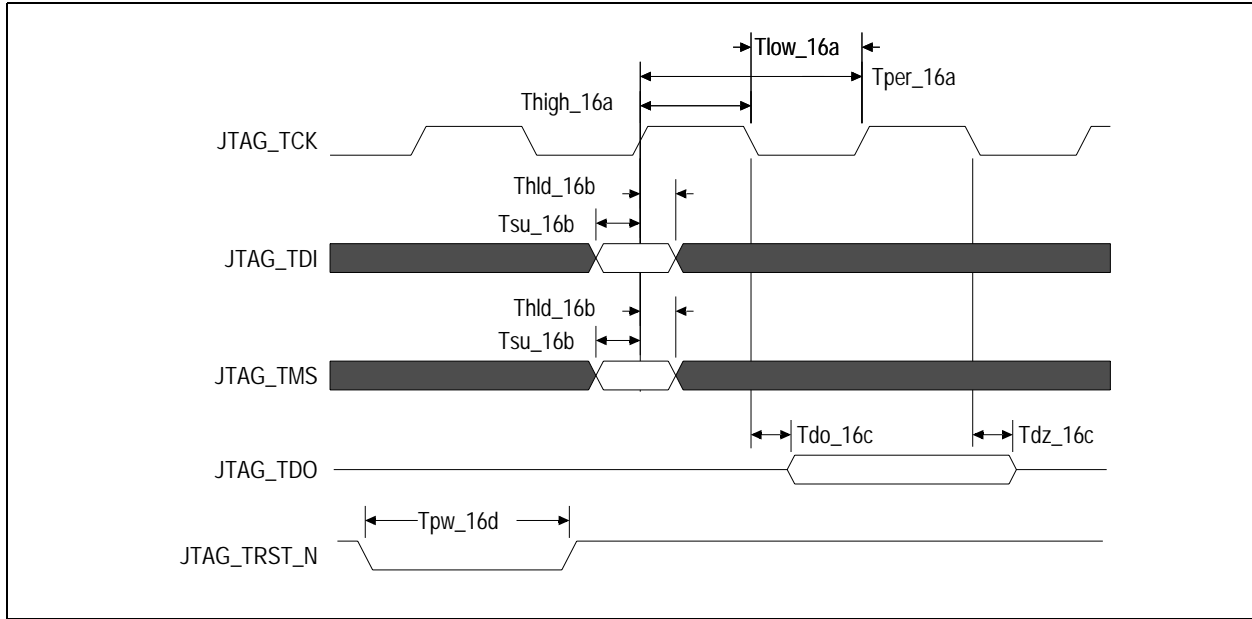

Figure 5 JTAG AC Timing Waveform

Recommended Operating Supply Voltages

| Symbol | Parameter | Minimum | Typical | Maximum | Unit |
|----------------------|--|---------|---------|---------|------|
| V _{DD} CORE | Internal logic supply | 0.9 | 1.0 | 1.1 | V |
| V _{DD} I/O | I/O supply except for SerDes LVPECL/CML | 3.0 | 3.3 | 3.6 | V |
| V _{DD} PE | PCI Express Digital Power | 0.9 | 1.0 | 1.1 | V |
| V _{DD} APE | PCI Express Analog Power | 0.9 | 1.0 | 1.1 | V |
| V _{TT} PE | PCI Express Serial Data Transmit Termination Voltage | 1.425 | 1.5 | 1.575 | V |
| V _{SS} | Common ground | 0 | 0 | 0 | V |

Table 13 PES24N3A Operating Voltages

Power-Up Sequence

This section describes the sequence in which various voltages must be applied to the part during power-up to ensure proper functionality. For the PES24N3A, the power-up sequence must be as follows:

1. V_{DD}I/O — 3.3V
2. V_{DD}Core, V_{DD}PE, V_{DD}APE — 1.0V
3. V_{TT}PE — 1.5V

When powering up, each voltage level must ramp and stabilize prior to applying the next voltage in the sequence to ensure internal latch-up issues are avoided. There are no maximum time limitations in ramping to valid power levels. The power-down sequence must be in the reverse order of the power-up sequence.

Recommended Operating Temperature

| Grade | Temperature |
|------------|----------------------|
| Commercial | 0°C to +70°C Ambient |

Table 14 PES24N3A Operating Temperatures

Power Consumption

Typical power is measured under the following conditions: 25°C Ambient, 35% total link usage on all ports, typical voltages defined in Table 13 (and also listed below).

Maximum power is measured under the following conditions: 70°C Ambient, 85% total link usage on all ports, maximum voltages defined in Table 13 (and also listed below).

| Number of active Lanes per Port | | Core Supply | | PCIe Digital Supply | | PCIe Analog Supply | | PCIe Termination Supply | | I/O Supply | | Total | |
|---------------------------------|-------|-------------|----------|---------------------|----------|--------------------|----------|-------------------------|------------|------------|----------|-----------|-----------|
| | | Typ 1.0V | Max 1.1V | Typ 1.0V | Max 1.1V | Typ 1.0V | Max 1.1V | Typ 1.5V | Max 1.575V | Typ 3.3V | Max 3.6V | Typ Power | Max Power |
| 8/8/8 | mA | 705 | 928 | 1037 | 1247 | 415 | 455 | 520 | 617 | 1 | 1 | 2.9W | 3.9W |
| | Watts | 0.705 | 1.02 | 1.037 | 1.37 | 0.415 | 0.50 | 0.78 | 0.97 | 0.003 | 0.004 | | |
| 8/4/4 | mA | 676 | 845 | 873 | 1004 | 409 | 434 | 360 | 408 | 1 | 1 | 2.5W | 3.2W |
| | Watts | 0.676 | 0.93 | 0.873 | 1.104 | 0.41 | 0.477 | 0.36 | 0.643 | 0.003 | 0.004 | | |

Table 15 PES24N3A Power Consumption

Thermal Considerations

This section describes thermal considerations for the PES24N3A (27mm² BXG420 package). The data in Table 16 below contains information that is relevant to the thermal performance of the PES24N3A switch.

| Symbol | Parameter | Value | Units | Conditions |
|--------------------------|---|-------|-------|---------------------------------------|
| $T_{J(max)}$ | Junction Temperature | 125 | °C | Maximum |
| $T_{A(max)}$ | Ambient Temperature | 70 | °C | Maximum for commercial-rated products |
| $\theta_{JA(effective)}$ | Effective Thermal Resistance, Junction-to-Ambient | 10.6 | °C/W | Zero air flow |
| | | 8.5 | °C/W | 1 m/S air flow |
| | | 7.6 | °C/W | 2 m/S air flow |
| θ_{JB} | Thermal Resistance, Junction-to-Board | 6.8 | °C/W | |
| θ_{JC} | Thermal Resistance, Junction-to-Case | 0.7 | °C/W | |
| P | Power Dissipation of the Device | 3.9 | Watts | Maximum |

Table 16 Thermal Specifications for PES24N3A, 27x27 mm BXG420 Package

Note: The parameter $\theta_{JA(eff)}$ is not the *absolute* thermal resistance for the package as defined by JEDEC (JESD-51). Because resistance can vary with the number of board layers, size of the board, and airflow, $\theta_{JA(eff)}$ is the *effective* thermal resistance. The values for effective θ_{JA} given above are based on a 10-layer, standard height, full length (4.3"x12.2") PCIe add-in card.

Heat Sink

Table 17 lists heat sink requirements for the PES24N3A under three common usage scenarios. As shown in this table, a heat sink is not required in most cases.

| Air Flow | Board Size | Board Layers | Heat Sink Requirement |
|---------------|---|--------------|-----------------------|
| Zero | 3.9"x6.2" (ExpressModule form factor) or larger | 10 or more | No heat sink required |
| Zero | Any | 14 or more | No heat sink required |
| 1 m/S or more | Any | Any | No heat sink required |

Table 17 Heat Sink Requirements Based on Air Flow and Board Characteristics

Thermal Usage Examples

The junction-to-ambient thermal resistance is a measure of a device's ability to dissipate heat from the die to its surroundings in the absence of a heat sink. The general formula to determine θ_{JA} is:

$$\theta_{JA} = (T_J - T_A) / P$$

Thermal reliability of a device is generally assured when the actual value of T_J in the specific system environment being considered is less than the maximum T_J specified for the device. Using an ambient temperature of 70°C and assuming a system with 1m/S airflow, the actual value of T_J is:

$$T_{J(actual)} = T_A + P * \theta_{JA(eff)} = 70^\circ C + 3.9W * 8.5W/\rho C = 103^\circ C$$

The actual T_J of 103°C is well below the maximum T_J of 125°C specified for the device (shown in Table 16). Therefore, no heat sink is needed in this scenario. The formula is also useful from a system design perspective. It can be used to determine if a heat sink should be added to the device based on some desired value of T_J . For example, if for reliability purposes the desired T_J is 100°C, then the maximum allowable T_A is:

$$T_{A(allowed)} = T_{J(desired)} - (P * \theta_{JA(effective)})$$

$$T_{A(allowed)} = 100^\circ C - (3.9W * 8.5W/\rho C) = 100^\circ C - 33^\circ C = 67^\circ C$$

An appropriate level of increased air flow and/or a heat sink can be added to achieve this lower ambient temperature. Please contact ssdhelp@idt.com for further assistance.

DC Electrical Characteristics

Values based on systems running at recommended supply voltages, as shown in Table 13.

Note: See Table 8, Pin Characteristics, for a complete I/O listing.

| I/O Type | Parameter | Description | Min ¹ | Typ ¹ | Max ¹ | Unit | Conditions |
|----------------------------------|---|---|------------------|------------------|------------------|------|------------|
| Serial Link | PCIe Transmit | | | | | | |
| | V _{TX-DIFFp-p} | Differential peak-to-peak output voltage | 800 | | 1200 | mV | |
| | V _{TX-DE-RATIO} | De-emphasized differential output voltage | -3 | | -4 | dB | |
| | V _{TX-DC-CM} | DC Common mode voltage | -0.1 | 1 | 3.7 | V | |
| | V _{TX-CM-ACP} | RMS AC peak common mode output voltage | | | 20 | mV | |
| | V _{TX-CM-DC-active-idle-delta} | Abs delta of DC common mode voltage between L0 and idle | | | 100 | mV | |
| | V _{TX-CM-DC-line-delta} | Abs delta of DC common mode voltage between D+ and D- | | | 25 | mV | |
| | V _{TX-Idle-DIFF} | Electrical idle diff peak output | | | 20 | mV | |
| Serial Link (cont.) | V _{TX-RCV-Detect} | Voltage change during receiver detection | | | 600 | mV | |
| | RL _{TX-DIFF} | Transmitter Differential Return loss | 12 | | | dB | |
| | RL _{TX-CM} | Transmitter Common Mode Return loss | 6 | | | dB | |
| | Z _{TX-DEFF-DC} | DC Differential TX impedance | 80 | 100 | 120 | Ω | |
| | Z _{OSE} | Single ended TX Impedance | 40 | 50 | 60 | Ω | |
| | Transmitter Eye Diagram | TX Eye Height (De-emphasized bits) | 505 | 650 | | mV | |
| | Transmitter Eye Diagram | TX Eye Height (Transition bits) | 800 | 950 | | mV | |
| | PCIe Receive | | | | | | |
| | V _{RX-DIFFp-p} | Differential input voltage (peak-to-peak) | 175 | | 1200 | mV | |
| | V _{RX-CM-AC} | Receiver common-mode voltage for AC coupling | | | 150 | mV | |
| | RL _{RX-DIFF} | Receiver Differential Return Loss | 15 | | | dB | |
| | RL _{RX-CM} | Receiver Common Mode Return Loss | 6 | | | dB | |
| | Z _{RX-DIFF-DC} | Differential input impedance (DC) | 80 | 100 | 120 | Ω | |
| | Z _{RX-COMM-DC} | Single-ended input impedance | 40 | 50 | 60 | Ω | |
| Z _{RX-COMM-HIGH-Z-DC} | Powered down input common mode impedance (DC) | 200k | 350k | | Ω | | |
| V _{RX-IDLE-DET-DIFFp-p} | Electrical idle detect threshold | 65 | | 175 | mV | | |
| PCIe REFCLK | | | | | | | |
| | C _{IN} | Input Capacitance | 1.5 | — | | pF | |

Table 18 DC Electrical Characteristics (Part 1 of 2)

| I/O Type | Parameter | Description | Min ¹ | Typ ¹ | Max ¹ | Unit | Conditions |
|-----------------------------|---|-------------|------------------|------------------|---------------------------|------|---------------------------|
| Other I/Os | | | | | | | |
| LOW Drive Output | I _{OL} | | — | 2.5 | — | mA | V _{OL} = 0.4v |
| | I _{OH} | | — | -5.5 | — | mA | V _{OH} = 1.5V |
| High Drive Output | I _{OL} | | — | 12.0 | — | mA | V _{OL} = 0.4v |
| | I _{OH} | | — | -20.0 | — | mA | V _{OH} = 1.5V |
| Schmitt Trigger Input (STI) | V _{IL} | | -0.3 | — | 0.8 | V | — |
| | V _{IH} | | 2.0 | — | V _{DD} I/O + 0.5 | V | — |
| Input | V _{IL} | | -0.3 | — | 0.8 | V | — |
| | V _{IH} | | 2.0 | — | V _{DD} I/O + 0.5 | V | — |
| Capacitance | C _{IN} | | — | — | 8.5 | pF | — |
| Leakage | Inputs | | — | — | ± 10 | μA | V _{DD} I/O (max) |
| | I/O _{LEAK} w/o Pull-ups/downs | | — | — | ± 10 | μA | V _{DD} I/O (max) |
| | I/O _{LEAK} WITH Pull-ups/downs | | — | — | ± 80 | μA | V _{DD} I/O (max) |

Table 18 DC Electrical Characteristics (Part 2 of 2)

¹: Minimum, Typical, and Maximum values meet the requirements under PCI Specification 1.1.

Package Pinout — 420-BGA Signal Pinout for PES24N3A

The following table lists the pin numbers and signal names for the PES24N3A device.

| Pin | Function | Alt | Pin | Function | Alt | Pin | Function | Alt | Pin | Function | Alt |
|-----|--------------------|-----|-----|----------------------|-----|-----|----------------------|-----|-----|----------------------|-----|
| A1 | V _{SS} | | B9 | MSMBDAT | | C17 | V _{DD} IO | | D25 | V _{SS} | |
| A2 | V _{SS} | | B10 | SSMBADDR_2 | | C18 | V _{SS} | | D26 | PEREFCLKN2 | |
| A3 | V _{SS} | | B11 | SSMBADDR_5 | | C19 | V _{DD} IO | | E1 | V _{SS} | |
| A4 | JTAG_TDI | | B12 | SSMBDAT | | C20 | V _{SS} | | E2 | V _{SS} | |
| A5 | JTAG_TMS | | B13 | NC | | C21 | V _{DD} IO | | E3 | V _{SS} | |
| A6 | MSMBADDR_1 | | B14 | SWMODE_0 | | C22 | V _{SS} | | E4 | V _{SS} | |
| A7 | MSMBADDR_3 | | B15 | SWMODE_2 | | C23 | V _{DD} IO | | E5 | V _{SS} | |
| A8 | MSMBCLK | | B16 | NC | | C24 | V _{SS} | | E6 | V _{DD} CORE | |
| A9 | SSMBADDR_1 | | B17 | V _{DD} IO | | C25 | V _{SS} | | E7 | V _{DD} CORE | |
| A10 | SSMBADDR_3 | | B18 | GPIO_00 | 1 | C26 | PEREFCLKP2 | | E8 | V _{SS} | |
| A11 | SSMBCLK | | B19 | GPIO_02 | 1 | D1 | PEREFCLKP1 | | E9 | V _{DD} CORE | |
| A12 | CCLKUS | | B20 | GPIO_04 | 1 | D2 | V _{SS} | | E10 | V _{SS} | |
| A13 | CCLKDS | | B21 | GPIO_06 | | D3 | V _{SS} | | E11 | V _{DD} CORE | |
| A14 | NC | | B22 | MSMBSMODE | | D4 | V _{SS} | | E12 | V _{SS} | |
| A15 | SWMODE_1 | | B23 | REFCLKM | | D5 | V _{DD} CORE | | E13 | V _{DD} CORE | |
| A16 | SWMODE_3 | | B24 | V _{DD} IO | | D6 | V _{DD} CORE | | E14 | V _{SS} | |
| A17 | PERSTN | | B25 | V _{SS} | | D7 | V _{SS} | | E15 | V _{DD} CORE | |
| A18 | RSTHALT | | B26 | V _{SS} | | D8 | V _{DD} CORE | | E16 | V _{SS} | |
| A19 | GPIO_01 | 1 | C1 | PEREFCLKN1 | | D9 | V _{SS} | | E17 | V _{DD} CORE | |
| A20 | GPIO_03 | | C2 | V _{SS} | | D10 | V _{DD} CORE | | E18 | V _{SS} | |
| A21 | GPIO_05 | | C3 | V _{SS} | | D11 | V _{SS} | | E19 | V _{DD} CORE | |
| A22 | GPIO_07 | 1 | C4 | V _{DD} CORE | | D12 | V _{DD} CORE | | E20 | V _{DD} CORE | |
| A23 | V _{SS} | | C5 | V _{DD} IO | | D13 | V _{DD} CORE | | E21 | V _{DD} CORE | |
| A24 | V _{SS} | | C6 | V _{SS} | | D14 | V _{SS} | | E22 | V _{SS} | |
| A25 | V _{SS} | | C7 | V _{DD} IO | | D15 | V _{DD} CORE | | E23 | V _{SS} | |
| A26 | V _{SS} | | C8 | V _{SS} | | D16 | V _{SS} | | E24 | V _{SS} | |
| B1 | V _{SS} | | C9 | V _{DD} IO | | D17 | V _{DD} CORE | | E25 | V _{SS} | |
| B2 | V _{SS} | | C10 | V _{SS} | | D18 | V _{DD} CORE | | E26 | V _{SS} | |
| B3 | V _{DD} IO | | C11 | V _{DD} IO | | D19 | V _{DD} CORE | | F1 | V _{DD} CORE | |
| B4 | JTAG_TCK | | C12 | V _{SS} | | D20 | V _{SS} | | F2 | V _{DD} CORE | |
| B5 | JTAG-TDO | | C13 | V _{DD} IO | | D21 | V _{DD} CORE | | F3 | V _{DD} APE | |
| B6 | JTAG-TRST_N | | C14 | V _{DD} CORE | | D22 | V _{DD} CORE | | F4 | V _{SS} | |
| B7 | MSMBADDR_2 | | C15 | V _{DD} IO | | D23 | V _{SS} | | F5 | V _{SS} | |
| B8 | MSMBADDR_4 | | C16 | V _{DD} CORE | | D24 | V _{SS} | | F22 | V _{SS} | |

Table 19 PES24N3A 420-pin Signal Pin-Out (Part 1 of 3)

| Pin | Function | Alt | Pin | Function | Alt | Pin | Function | Alt | Pin | Function | Alt |
|-----|----------------------|-----|-----|----------------------|-----|-----|----------------------|-----|-----|----------------------|-----|
| F23 | V _{SS} | | K4 | V _{DD} APE | | P1 | V _{DD} CORE | | U24 | V _{DD} PE | |
| F24 | V _{DD} APE | | K5 | V _{DD} APE | | P2 | V _{SS} | | U25 | PE4TP05 | |
| F25 | V _{DD} CORE | | K22 | V _{DD} APE | | P3 | V _{TT} PE | | U26 | PE4TN05 | |
| F26 | V _{DD} CORE | | K23 | V _{DD} APE | | P4 | V _{TT} PE | | V1 | V _{DD} CORE | |
| G1 | PE2TN07 | | K24 | V _{DD} APE | | P5 | V _{SS} | | V2 | V _{SS} | |
| G2 | PE2TP07 | | K25 | V _{SS} | | P22 | V _{SS} | | V3 | V _{DD} APE | |
| G3 | V _{DD} PE | | K26 | V _{SS} | | P23 | V _{TT} PE | | V4 | V _{DD} APE | |
| G4 | PE2RN07 | | L1 | PE2TN05 | | P24 | V _{TT} PE | | V5 | V _{DD} APE | |
| G5 | PE2RP07 | | L2 | PE2TP05 | | P25 | V _{SS} | | V22 | V _{DD} APE | |
| G22 | PE4RP00 | | L3 | V _{DD} PE | | P26 | V _{DD} CORE | | V23 | V _{DD} APE | |
| G23 | PE4RN00 | | L4 | PE2RN05 | | R1 | PE2TN03 | | V24 | V _{DD} APE | |
| G24 | V _{DD} PE | | L5 | PE2RP05 | | R2 | PE2TP03 | | V25 | V _{SS} | |
| G25 | PE4TP00 | | L22 | PE4RP02 | | R3 | V _{DD} PE | | V26 | V _{DD} CORE | |
| G26 | PE4TN00 | | L23 | PE4RN02 | | R4 | PE2RN03 | | W1 | PE2TN01 | |
| H1 | V _{SS} | | L24 | V _{DD} PE | | R5 | PE2RP03 | | W2 | PE2TP01 | |
| H2 | V _{SS} | | L25 | PE4TP02 | | R22 | PE4RP04 | | W3 | V _{DD} PE | |
| H3 | V _{TT} PE | | L26 | PE4TN02 | | R23 | PE4RN04 | | W4 | PE2RN01 | |
| H4 | V _{TT} PE | | M1 | V _{DD} CORE | | R24 | V _{DD} PE | | W5 | PE2RP01 | |
| H5 | V _{SS} | | M2 | V _{SS} | | R25 | PE4TP04 | | W22 | PE4RP06 | |
| H22 | V _{SS} | | M3 | V _{TT} PE | | R26 | PE4TN04 | | W23 | PE4RN06 | |
| H23 | V _{TT} PE | | M4 | V _{TT} PE | | T1 | V _{DD} CORE | | W24 | V _{DD} PE | |
| H24 | V _{TT} PE | | M5 | V _{SS} | | T2 | V _{SS} | | W25 | PE4TP06 | |
| H25 | V _{SS} | | M22 | V _{SS} | | T3 | V _{DD} APE | | W26 | PE4TN06 | |
| H26 | V _{SS} | | M23 | V _{TT} PE | | T4 | V _{DD} APE | | Y1 | V _{SS} | |
| J1 | PE2TN06 | | M24 | V _{TT} PE | | T5 | V _{SS} | | Y2 | V _{SS} | |
| J2 | PE2TP06 | | M25 | V _{SS} | | T22 | V _{SS} | | Y3 | V _{TT} PE | |
| J3 | V _{DD} PE | | M26 | V _{DD} CORE | | T23 | V _{DD} APE | | Y4 | V _{TT} PE | |
| J4 | PE2RN06 | | N1 | PE2TN04 | | T24 | V _{DD} APE | | Y5 | V _{SS} | |
| J5 | PE2RP06 | | N2 | PE2TP04 | | T25 | V _{SS} | | Y22 | V _{SS} | |
| J22 | PE4RP01 | | N3 | V _{DD} PE | | T26 | V _{DD} CORE | | Y23 | V _{TT} PE | |
| J23 | PE4RN01 | | N4 | PE2RN04 | | U1 | PE2TN02 | | Y24 | V _{TT} PE | |
| J24 | V _{DD} PE | | N5 | PE2RP04 | | U2 | PE2TP02 | | Y25 | V _{SS} | |
| J25 | PE4TP01 | | N22 | PE4RP03 | | U3 | V _{DD} PE | | Y26 | V _{SS} | |
| J26 | PE4TN01 | | N23 | PE4RN03 | | U4 | PE2RN02 | | AA1 | PE2TN00 | |
| K1 | V _{SS} | | N24 | V _{DD} PE | | U5 | PE2RP02 | | AA2 | PE2TP00 | |
| K2 | V _{SS} | | N25 | PE4TP03 | | U22 | PE4RP05 | | AA3 | V _{DD} PE | |
| K3 | V _{DD} APE | | N26 | PE4TN03 | | U23 | PE4RN05 | | AA4 | PE2RN00 | |

Table 19 PES24N3A 420-pin Signal Pin-Out (Part 2 of 3)

| Pin | Function | Alt | Pin | Function | Alt | Pin | Function | Alt | Pin | Function | Alt |
|------|----------------------|-----|------|----------------------|-----|------|----------------------|-----|------|----------------------|-----|
| AA5 | PE2RP00 | | AC3 | V _{DD} CORE | | AD11 | V _{DD} PE | | AE19 | PE0TP01 | |
| AA22 | PE4RP07 | | AC4 | V _{DD} CORE | | AD12 | V _{TT} PE | | AE20 | V _{SS} | |
| AA23 | PE4RN07 | | AC5 | V _{DD} CORE | | AD13 | V _{DD} PE | | AE21 | PE0TP00 | |
| AA24 | V _{DD} PE | | AC6 | V _{TT} PE | | AD14 | V _{TT} PE | | AE22 | V _{SS} | |
| AA25 | PE4TP07 | | AC7 | PE0RN07 | | AD15 | V _{DD} PE | | AE23 | V _{DD} CORE | |
| AA26 | PE4TN07 | | AC8 | V _{DD} APE | | AD16 | V _{DD} APE | | AE24 | V _{DD} CORE | |
| AB1 | V _{SS} | | AC9 | PE0RN06 | | AD17 | V _{SS} | | AE25 | V _{SS} | |
| AB2 | V _{SS} | | AC10 | V _{DD} APE | | AD18 | V _{DD} PE | | AE26 | V _{SS} | |
| AB3 | V _{DD} CORE | | AC11 | PE0RN05 | | AD19 | V _{DD} PE | | AF1 | V _{SS} | |
| AB4 | V _{DD} CORE | | AC12 | V _{TT} PE | | AD20 | V _{TT} PE | | AF2 | V _{SS} | |
| AB5 | V _{DD} CORE | | AC13 | PE0RN04 | | AD21 | V _{DD} PE | | AF3 | V _{DD} CORE | |
| AB6 | V _{SS} | | AC14 | V _{TT} PE | | AD22 | V _{SS} | | AF4 | V _{DD} CORE | |
| AB7 | PE0RP07 | | AC15 | PE0RN03 | | AD23 | V _{DD} CORE | | AF5 | V _{DD} CORE | |
| AB8 | V _{SS} | | AC16 | V _{DD} APE | | AD24 | V _{DD} CORE | | AF6 | V _{SS} | |
| AB9 | PE0RP06 | | AC17 | PE0RN02 | | AD25 | V _{SS} | | AF7 | PE0TN07 | |
| AB10 | V _{DD} APE | | AC18 | V _{DD} APE | | AD26 | V _{SS} | | AF8 | V _{SS} | |
| AB11 | PE0RP05 | | AC19 | PE0RN01 | | AE1 | V _{SS} | | AF9 | PE0TN06 | |
| AB12 | V _{SS} | | AC20 | V _{TT} PE | | AE2 | V _{SS} | | AF10 | V _{DD} CORE | |
| AB13 | PE0RP04 | | AC21 | PE0RN00 | | AE3 | V _{DD} CORE | | AF11 | PE0TN05 | |
| AB14 | V _{DD} APE | | AC22 | V _{SS} | | AE4 | V _{DD} CORE | | AF12 | V _{DD} CORE | |
| AB15 | PE0RP03 | | AC23 | V _{DD} CORE | | AE5 | V _{SS} | | AF13 | PE0TN04 | |
| AB16 | V _{SS} | | AC24 | V _{DD} CORE | | AE6 | V _{SS} | | AF14 | V _{DD} CORE | |
| AB17 | PE0RP02 | | AC25 | V _{SS} | | AE7 | PE0TP07 | | AF15 | PE0TN03 | |
| AB18 | V _{DD} APE | | AC26 | V _{SS} | | AE8 | V _{SS} | | AF16 | V _{DD} CORE | |
| AB19 | PE0RP01 | | AD1 | V _{SS} | | AE9 | PE0TP06 | | AF17 | PE0TN02 | |
| AB20 | V _{SS} | | AD2 | V _{SS} | | AE10 | V _{SS} | | AF18 | V _{SS} | |
| AB21 | PE0RP00 | | AD3 | V _{DD} CORE | | AE11 | PE0TP05 | | AF19 | PE0TN01 | |
| AB22 | V _{SS} | | AD4 | V _{DD} CORE | | AE12 | V _{SS} | | AF20 | V _{SS} | |
| AB23 | V _{DD} CORE | | AD5 | V _{DD} CORE | | AE13 | PE0TP04 | | AF21 | PE0TN00 | |
| AB24 | V _{DD} CORE | | AD6 | V _{TT} PE | | AE14 | V _{SS} | | AF22 | V _{SS} | |
| AB25 | V _{SS} | | AD7 | V _{SS} | | AE15 | PE0TP03 | | AF23 | V _{DD} CORE | |
| AB26 | V _{SS} | | AD8 | V _{DD} PE | | AE16 | V _{SS} | | AF24 | V _{DD} CORE | |
| AC1 | V _{SS} | | AD9 | V _{SS} | | AE17 | PE0TP02 | | AF25 | V _{SS} | |
| AC2 | V _{SS} | | AD10 | V _{DD} PE | | AE18 | V _{SS} | | AF26 | V _{SS} | |

Table 19 PES24N3A 420-pin Signal Pin-Out (Part 3 of 3)

Power Pins

| V _{DD} Core | V _{DD} Core | V _{DD} Core | V _{DD} IO | V _{DD} PE | V _{DD} APE | V _{TT} PE |
|----------------------|----------------------|----------------------|--------------------|--------------------|---------------------|--------------------|
| C4 | F2 | AE3 | B3 | G3 | F3 | H3 |
| C14 | F25 | AE4 | B17 | G24 | F24 | H4 |
| C16 | F26 | AE23 | B24 | J3 | K3 | H23 |
| D5 | M1 | AE24 | C5 | J24 | K4 | H24 |
| D6 | M26 | AF3 | C7 | L3 | K5 | M3 |
| D8 | P1 | AF4 | C9 | L24 | K22 | M4 |
| D10 | P26 | AF5 | C11 | N3 | K23 | M23 |
| D12 | T1 | AF10 | C13 | N24 | K24 | M24 |
| D13 | T26 | AF12 | C15 | R3 | T3 | P3 |
| D15 | V1 | AF14 | C17 | R24 | T4 | P4 |
| D17 | V26 | AF16 | C19 | U3 | T23 | P23 |
| D18 | AB3 | AF23 | C21 | U24 | T24 | P24 |
| D19 | AB4 | AF24 | C23 | W3 | V3 | Y3 |
| D21 | AB5 | | | W24 | V4 | Y4 |
| D22 | AB23 | | | AA3 | V5 | Y23 |
| E6 | AB24 | | | AA24 | V22 | Y24 |
| E7 | AC3 | | | AD8 | V23 | AC6 |
| E9 | AC4 | | | AD10 | V24 | AC12 |
| E11 | AC5 | | | AD11 | AB10 | AC14 |
| E13 | AC23 | | | AD13 | AB14 | AC20 |
| E15 | AC24 | | | AD15 | AB18 | AD6 |
| E17 | AD3 | | | AD18 | AC8 | AD12 |
| E19 | AD4 | | | AD19 | AC10 | AD14 |
| E20 | AD5 | | | AD21 | AC16 | AD20 |
| E21 | AD23 | | | | AC18 | |
| F1 | AD24 | | | | AD16 | |

Table 20 PES24N3A Power Pins

Ground Pins

| V_{SS} | V_{SS} | V_{SS} | V_{SS} | V_{SS} |
|----------|----------|----------|----------|----------|
| A1 | D9 | F22 | Y1 | AD22 |
| A2 | D11 | F23 | Y2 | AD25 |
| A3 | D14 | H1 | Y5 | AD26 |
| A23 | D16 | H2 | Y22 | AE1 |
| A24 | D20 | H5 | Y25 | AE2 |
| A25 | D23 | H22 | Y26 | AE5 |
| A26 | D24 | H25 | AB1 | AE6 |
| B1 | D25 | H26 | AB2 | AE8 |
| B2 | E1 | K1 | AB6 | AE10 |
| B25 | E2 | K2 | AB8 | AE12 |
| B26 | E3 | K25 | AB12 | AE14 |
| C2 | E4 | K26 | AB16 | AE16 |
| C3 | E5 | M2 | AB20 | AE18 |
| C6 | E8 | M5 | AB22 | AE20 |
| C8 | E10 | M22 | AB25 | AE22 |
| C10 | E12 | M25 | AB26 | AE25 |
| C12 | E14 | P2 | AC1 | AE26 |
| C18 | E16 | P5 | AC2 | AF1 |
| C20 | E18 | P22 | AC22 | AF2 |
| C22 | E22 | P25 | AC25 | AF6 |
| C24 | E23 | T2 | AC26 | AF8 |
| C25 | E24 | T5 | AD1 | AF18 |
| D2 | E25 | T22 | AD2 | AF20 |
| D3 | E26 | T25 | AD7 | AF22 |
| D4 | F4 | V2 | AD9 | AF25 |
| D7 | F5 | V25 | AD17 | AF26 |

Table 21 PES24N3A Ground Pins

Alternate Signal Functions

| Pin | GPIO | Alternate |
|-----|---------|------------|
| B18 | GPIO_00 | P2RSTN |
| A19 | GPIO_01 | P4RSTN |
| B19 | GPIO_02 | IOEXPINTN0 |
| B20 | GPIO_04 | IOEXPINTN2 |
| A22 | GPIO_07 | GPEN |

Table 22 PES24N3A Alternate Signal Functions

Signals Listed Alphabetically

| Signal Name | I/O Type | Location | Signal Category |
|-------------|----------|----------|------------------------------|
| CCLKDS | I | A13 | System |
| CCLKUS | I | A12 | |
| GPIO_00 | I/O | B18 | General Purpose Input/Output |
| GPIO_01 | I/O | A19 | |
| GPIO_02 | I/O | B19 | |
| GPIO_03 | I/O | A20 | |
| GPIO_04 | I/O | B20 | |
| GPIO_05 | I/O | A21 | |
| GPIO_06 | I/O | B21 | |
| GPIO_07 | I/O | A22 | |
| JTAG_TCK | I | B4 | JTAG |
| JTAG_TDI | I | A4 | |
| JTAG_TMS | I | A5 | |
| JTAG-TDO | O | B5 | |
| JTAG-TRST_N | I | B6 | |
| MSMBADDR_1 | I | A6 | SMBus |
| MSMBADDR_2 | I | B7 | |
| MSMBADDR_3 | I | A7 | |
| MSMBADDR_4 | I | B8 | |
| MSMBCLK | I/O | A8 | |
| MSMBDAT | I/O | B9 | |
| MSMBSMODE | I | B22 | System |

Table 23 89PES24N3A Alphabetical Signal List (Part 1 of 5)

| Signal Name | I/O Type | Location | Signal Category |
|-------------|----------|----------|-----------------|
| NC | | A14 | PCI Express |
| NC | | B13 | |
| NC | | B16 | |
| PE0RN00 | I | AC21 | |
| PE0RN01 | I | AC19 | |
| PE0RN02 | I | AC17 | |
| PE0RN03 | I | AC15 | |
| PE0RN04 | I | AC13 | |
| PE0RN05 | I | AC11 | |
| PE0RN06 | I | AC9 | |
| PE0RN07 | I | AC7 | |
| PE0RP00 | I | AB21 | |
| PE0RP01 | I | AB19 | |
| PE0RP02 | I | AB17 | |
| PE0RP03 | I | AB15 | |
| PE0RP04 | I | AB13 | |
| PE0RP05 | I | AB11 | |
| PE0RP06 | I | AB9 | |
| PE0RP07 | I | AB7 | |
| PE0TN00 | O | AF21 | |
| PE0TN01 | O | AF19 | |
| PE0TN02 | O | AF17 | |
| PE0TN03 | O | AF15 | |
| PE0TN04 | O | AF13 | |
| PE0TN05 | O | AF11 | |
| PE0TN06 | O | AF9 | |
| PE0TN07 | O | AF7 | |
| PE0TP00 | O | AE21 | |
| PE0TP01 | O | AE19 | |
| PE0TP02 | O | AE17 | |
| PE0TP03 | O | AE15 | |
| PE0TP04 | O | AE13 | |
| PE0TP05 | O | AE11 | |
| PE0TP06 | O | AE9 | |
| PE0TP07 | O | AE7 | |

Table 23 89PES24N3A Alphabetical Signal List (Part 2 of 5)

| Signal Name | I/O Type | Location | Signal Category |
|-------------|----------|----------|---------------------|
| PE2RN00 | I | AA4 | PCI Express (Cont.) |
| PE2RN01 | I | W4 | |
| PE2RN02 | I | U4 | |
| PE2RN03 | I | R4 | |
| PE2RN04 | I | N4 | |
| PE2RN05 | I | L4 | |
| PE2RN06 | I | J4 | |
| PE2RN07 | I | G4 | |
| PE2RP00 | I | AA5 | |
| PE2RP01 | I | W5 | |
| PE2RP02 | I | U5 | |
| PE2RP03 | I | R5 | |
| PE2RP04 | I | N5 | |
| PE2RP05 | I | L5 | |
| PE2RP06 | I | J5 | |
| PE2RP07 | I | G5 | |
| PE2TN00 | O | AA1 | |
| PE2TN01 | O | W1 | |
| PE2TN02 | O | U1 | |
| PE2TN03 | O | R1 | |
| PE2TN04 | O | N1 | |
| PE2TN05 | O | L1 | |
| PE2TN06 | O | J1 | |
| PE2TN07 | O | G1 | |
| PE2TP00 | O | AA2 | |
| PE2TP01 | O | W2 | |
| PE2TP02 | O | U2 | |
| PE2TP03 | O | R2 | |
| PE2TP04 | O | N2 | |
| PE2TP05 | O | L2 | |
| PE2TP06 | O | J2 | |
| PE2TP07 | O | G2 | |
| PE4RN00 | I | G23 | |
| PE4RN01 | I | J23 | |
| PE4RN02 | I | L23 | |
| PE4RN03 | I | N23 | |

Table 23 89PES24N3A Alphabetical Signal List (Part 3 of 5)

| Signal Name | I/O Type | Location | Signal Category |
|-------------|----------|----------|---------------------|
| PE4RN04 | I | R23 | PCI Express (Cont.) |
| PE4RN05 | I | U23 | |
| PE4RN06 | I | W23 | |
| PE4RN07 | I | AA23 | |
| PE4RP00 | I | G22 | |
| PE4RP01 | I | J22 | |
| PE4RP02 | I | L22 | |
| PE4RP03 | I | N22 | |
| PE4RP04 | I | R22 | |
| PE4RP05 | I | U22 | |
| PE4RP06 | I | W22 | |
| PE4RP07 | I | AA22 | |
| PE4TN00 | O | G26 | |
| PE4TN01 | O | J26 | |
| PE4TN02 | O | L26 | |
| PE4TN03 | O | N26 | |
| PE4TN04 | O | R26 | |
| PE4TN05 | O | U26 | |
| PE4TN06 | O | W26 | |
| PE4TN07 | O | AA26 | |
| PE4TP00 | O | G25 | |
| PE4TP01 | O | J25 | |
| PE4TP02 | O | L25 | |
| PE4TP03 | O | N25 | |
| PE4TP04 | O | R25 | |
| PE4TP05 | O | U25 | |
| PE4TP06 | O | W25 | |
| PE4TP07 | O | AA25 | |
| PEREFCLKN1 | I | C1 | |
| PEREFCLKN2 | I | D26 | |
| PEREFCLKP1 | I | D1 | |
| PEREFCLKP2 | I | C26 | |
| PERSTN | I | A17 | System |
| REFCLKM | I | B23 | PCI Express |
| RSTHALT | I | A18 | System |









Table 23 89PES24N3A Alphabetical Signal List (Part 4 of 5)

| Signal Name | I/O Type | Location | Signal Category |
|---|--|----------|-----------------|
| SSMBADDR_1 | I | A9 | SMBus |
| SSMBADDR_2 | I | B10 | |
| SSMBADDR_3 | I | A10 | |
| SSMBADDR_5 | I | B11 | |
| SSMBCLK | I/O | A11 | SMBus |
| SSMBDAT | I/O | B12 | |
| SWMODE_0 | I | B14 | System |
| SWMODE_1 | I | A15 | |
| SWMODE_2 | I | B15 | |
| SWMODE_3 | I | A16 | |
| V_{DDCORE} , V_{DDAPE} , V_{DDIO} , V_{DDPE} , V_{TTPE} | See Table 20 for a listing of power pins. | | |
| V_{SS} | See Table 21 for a listing of ground pins. | | |

Table 23 89PES24N3A Alphabetical Signal List (Part 5 of 5)

PES24N3A Pinout — Top View

| | 1 | 2 | 3 | 4 | 5 | 6 | 7 | 8 | 9 | 10 | 11 | 12 | 13 | 14 | 15 | 16 | 17 | 18 | 19 | 20 | 21 | 22 | 23 | 24 | 25 | 26 |
|----|---|---|---|---|---|---|---|---|---|----|----|----|----|----|----|----|----|----|----|----|----|----|----|----|----|----|
| A | ✓ | ✓ | ✓ | □ | □ | □ | □ | □ | □ | □ | □ | □ | □ | ✗ | □ | □ | □ | □ | □ | □ | □ | □ | ✓ | ✓ | ✓ | ✓ |
| B | ✓ | ✓ | ✗ | □ | □ | □ | □ | □ | □ | □ | □ | □ | ✗ | □ | □ | ✗ | ✗ | □ | □ | □ | □ | □ | □ | ✗ | ✓ | ✓ |
| C | □ | ✓ | ✓ | ✗ | ✗ | ✓ | ✗ | ✓ | ✗ | ✓ | ✗ | ✓ | ✗ | ✗ | ✗ | ✗ | ✓ | ✗ | ✓ | ✗ | ✓ | ✗ | ✓ | ✗ | ✓ | □ |
| D | □ | ✓ | ✓ | ✓ | ✗ | ✗ | ✓ | ✗ | ✓ | ✗ | ✓ | ✗ | ✗ | ✓ | ✗ | ✓ | ✗ | ✗ | ✗ | ✓ | ✗ | ✓ | ✗ | ✓ | ✓ | □ |
| E | ✓ | ✓ | ✓ | ✓ | ✓ | ✗ | ✗ | ✓ | ✗ | ✓ | ✗ | ✓ | ✗ | ✓ | ✗ | ✓ | ✗ | ✗ | ✗ | ✓ | ✗ | ✓ | ✗ | ✓ | ✓ | ✓ |
| F | ✗ | ✗ | ✗ | ✓ | ✓ | | | | | | | | | | | | | | | | | ✓ | ✓ | ✗ | ✗ | ✗ |
| G | □ | □ | ✗ | □ | □ | | | | | | | | | | | | | | | | | □ | □ | ✗ | □ | □ |
| H | ✓ | ✓ | ✗ | ✗ | ✓ | | | | | | | | | | | | | | | | | ✓ | ✗ | ✗ | ✓ | ✓ |
| J | □ | □ | ✗ | □ | □ | | | | | | | | | | | | | | | | | □ | □ | ✗ | □ | □ |
| K | ✓ | ✓ | ✗ | ✗ | ✗ | | | | | | | | | | | | | | | | | ✗ | ✗ | ✗ | ✓ | ✓ |
| L | □ | □ | ✗ | □ | □ | | | | | | | | | | | | | | | | | □ | □ | ✗ | □ | □ |
| M | ✗ | ✓ | ✗ | ✗ | ✓ | | | | | | | | | | | | | | | | | ✓ | ✗ | ✗ | ✓ | ✗ |
| N | □ | □ | ✗ | □ | □ | | | | | | | | | | | | | | | | | □ | □ | ✗ | □ | □ |
| P | ✗ | ✓ | ✗ | ✗ | ✓ | | | | | | | | | | | | | | | | | ✓ | ✗ | ✗ | ✓ | ✗ |
| R | □ | □ | ✗ | □ | □ | | | | | | | | | | | | | | | | | □ | □ | ✗ | □ | □ |
| T | ✗ | ✓ | ✗ | ✗ | ✓ | | | | | | | | | | | | | | | | | ✓ | ✗ | ✗ | ✓ | ✗ |
| U | □ | □ | ✗ | □ | □ | | | | | | | | | | | | | | | | | □ | □ | ✗ | □ | □ |
| V | ✗ | ✓ | ✗ | ✗ | ✗ | | | | | | | | | | | | | | | | | ✗ | ✗ | ✗ | ✓ | ✗ |
| W | □ | □ | ✗ | □ | □ | | | | | | | | | | | | | | | | | □ | □ | ✗ | □ | □ |
| Y | ✓ | ✓ | ✗ | ✗ | ✓ | | | | | | | | | | | | | | | | | ✓ | ✗ | ✗ | ✓ | ✓ |
| AA | □ | □ | ✗ | □ | □ | | | | | | | | | | | | | | | | | □ | □ | ✗ | □ | □ |
| AB | ✓ | ✓ | ✗ | ✗ | ✗ | ✓ | □ | ✓ | □ | ✗ | □ | ✓ | □ | ✗ | □ | ✓ | □ | ✗ | □ | ✓ | □ | ✓ | ✗ | ✗ | ✓ | ✓ |
| AC | ✓ | ✓ | ✗ | ✗ | ✗ | ✗ | □ | ✗ | □ | ✗ | □ | ✗ | □ | ✗ | □ | ✗ | □ | ✗ | □ | ✗ | □ | ✓ | ✗ | ✗ | ✓ | ✓ |
| AD | ✓ | ✓ | ✗ | ✗ | ✗ | ✗ | ✓ | ✗ | ✗ | ✗ | ✗ | ✗ | ✗ | ✗ | ✗ | ✗ | ✗ | ✗ | ✗ | ✗ | ✗ | ✗ | ✗ | ✗ | ✗ | ✗ |
| AE | ✓ | ✓ | ✗ | ✗ | ✓ | ✓ | □ | ✓ | □ | ✓ | □ | ✓ | □ | ✓ | □ | ✓ | □ | ✓ | □ | ✓ | □ | ✓ | □ | ✓ | ✗ | ✓ |
| AF | ✓ | ✓ | ✗ | ✗ | ✗ | ✓ | □ | ✓ | □ | ✗ | □ | ✗ | □ | ✗ | □ | ✗ | □ | ✓ | □ | ✓ | □ | ✓ | ✗ | ✗ | ✓ | ✓ |

| | | | |
|--|---|---|---|
|  $V_{DD}Core$ (Power) |  $V_{TT}PE$ (Power) |  V_{SS} (Ground) |  Signals |
|  $V_{DD}I/O$ (Power) |  $V_{DD}PE$ (Power) | |  Not connected |
| |  $V_{DD}APE$ (Power) | | |

PES24N3A Package Drawing — 420-Pin BX420/BXG420

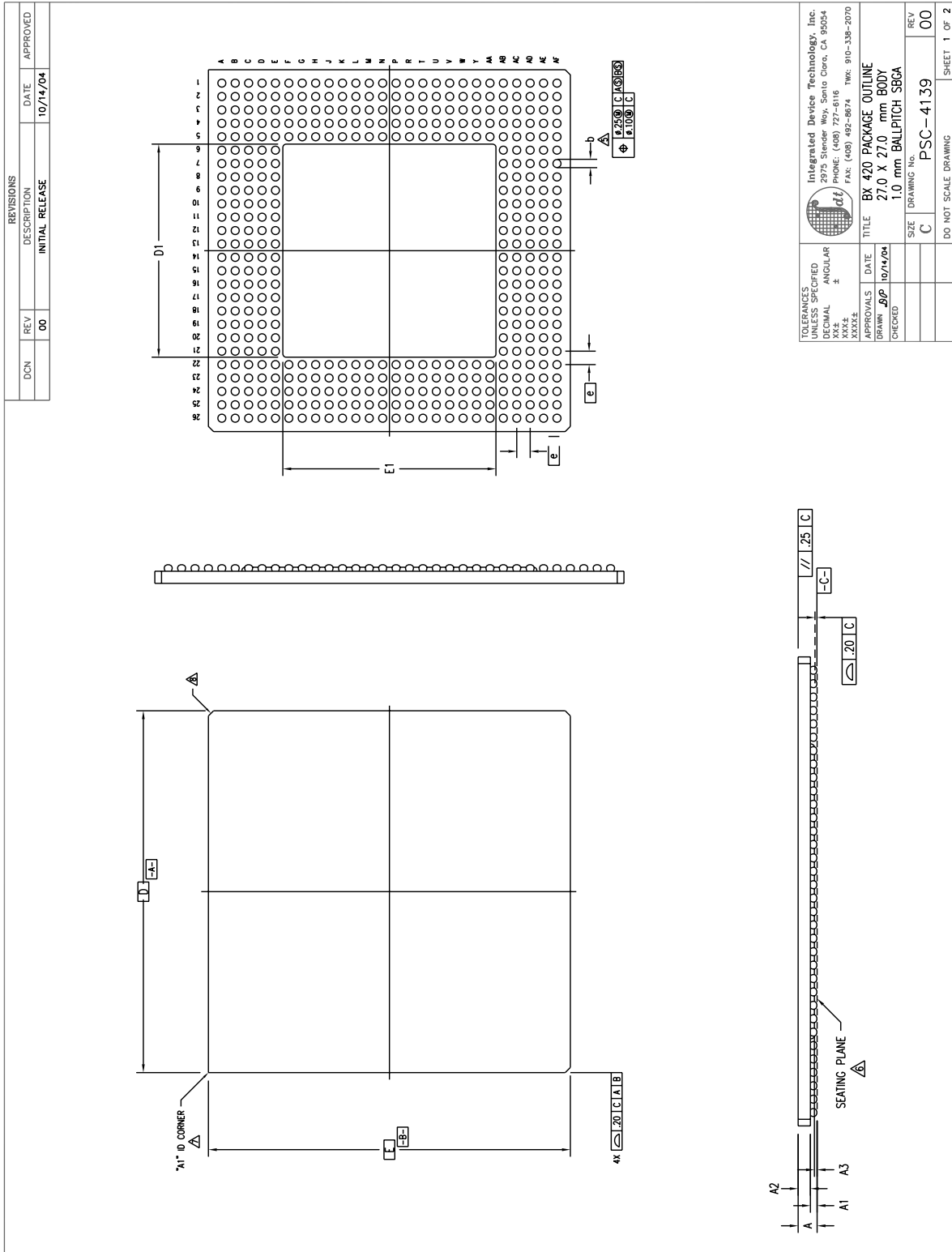

PES24N3A Package Drawing — Page Two

| REVISIONS | | |
|-----------------|-----|----------|
| DCN | REV | DATE |
| | 00 | 10/14/04 |
| DESCRIPTION | | APPROVED |
| INITIAL RELEASE | | |

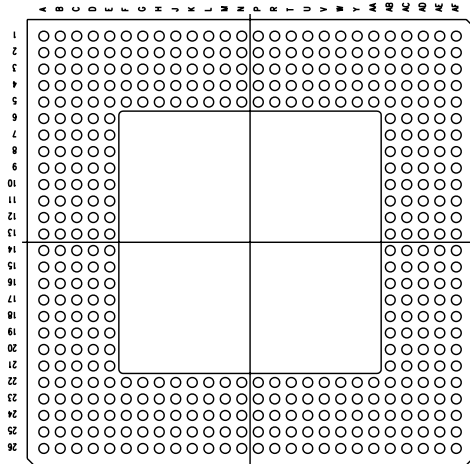

NOTES:

- 1 ALL DIMENSIONING AND TOLERANCING CONFORM TO ANSI Y14.5M-1982
- 2 "e" REPRESENTS THE BASIC SOLDER BALL GRID PITCH
- 3 "M" REPRESENTS THE MAXIMUM SOLDER BALL MATRIX SIZE
- 4 "N" REPRESENTS THE BALLCOUNT NUMBER
- 5 DIMENSION "b" IS MEASURED AT THE MAXIMUM SOLDER BALL DIAMETER, PARALLEL TO PRIMARY DATUM \square -C-
- 6 SEATING PLANE AND PRIMARY DATUM \square -C- ARE DEFINED BY THE SPHERICAL CROWNS OF THE SOLDER BALLS
- 7 "A1" ID CORNER MUST BE IDENTIFIED BY CHAMFER, INK MARK, METALLIZED MARKING, INDENTATION OR OTHER FEATURE ON PACKAGE BODY
- 8 EXACT SHAPE OF EACH CORNER IS OPTIONAL
- 9 ALL DIMENSIONS ARE IN MILLIMETERS

| SYMBOL | JEDEC VARIATION | | | NOMINAL |
|--------------------|------------------|-----------|------|---------|
| | MIN | NOM | MAX | |
| A | - | - | 1.70 | |
| A1 | .30 | - | - | |
| A2 | .25 | - | 1.10 | |
| A3 | .15 | - | - | |
| D | - | 27.00 BSC | - | |
| D1 | - | - | 15.9 | |
| E | - | 27.00 BSC | - | |
| E1 | - | - | 15.9 | |
| M | 26 (DEPOPULATED) | - | - | 3 |
| N | - | 420 | - | 4 |
| e | - | 1.00 BSC | - | |
| b | .50 | .60 | .70 | 5 |
| CENTER BALL MATRIX | N/A | | | |

| | |
|---|------------------------------|
|  Integrated Device Technology, Inc. 2975 Steiner Way, Santa Clara, CA 95054 PHONE: (408) 727-6116 FAX: (408) 492-8674 TWR: 910-338-2070 | |
| TOLERANCES UNLESS SPECIFIED DECIMAL ANGULAR XX± XXX± | DATE 10/14/04 |
| APPROVALS <i>BP</i> | TITLE BX 420 PACKAGE OUTLINE |
| DRAWN | 27.0 X 27.0 mm BODY |
| CHECKED | 1.0 mm BALLPITCH SBCA |
| SIZE | DRAWING No. PSC-4139 |
| REV | 00 |
| DO NOT SCALE DRAWING | |
| SHEET 2 OF 2 | |

Revision History

February 8, 2007: Initial publication.

April 4, 2007: In Table 3, revised description for MSMBCLK signal.

May 30, 2007: Added ZG device revision to Ordering Information.

November 14, 2007: Added new parameter, Termination Resistor, to Table 9, Input Clock Requirements.

March 25, 2008: Added θ_{JB} and θ_{JC} parameters to Table 16, Thermal Specifications.

April 23, 2008: Added 1ZC device revision to Ordering Information.

Ordering Information

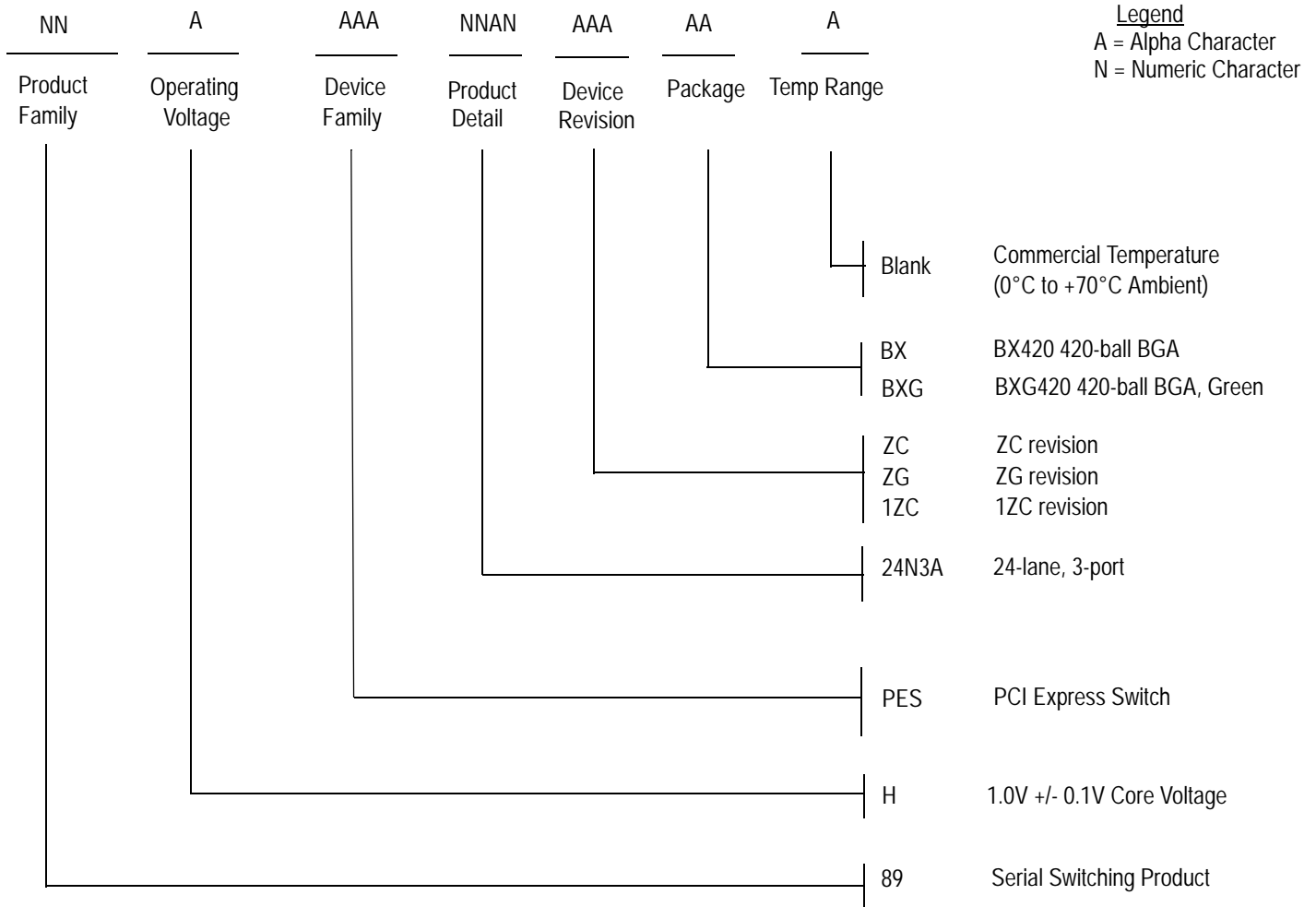

Valid Combinations

| | |
|-------------------|---|
| 89HPES24N3AZCBX | 420-pin BX420 package, Commercial Temperature |
| 89HPES24N3AZGBX | 420-pin BX420 package, Commercial Temperature |
| 89HPES24N3A1ZCBX | 420-pin BX420 package, Commercial Temperature |
| 89HPES24N3AZCBXG | 420-pin Green BX420 package, Commercial Temperature |
| 89HPES24N3AZGBXG | 420-pin Green BX420 package, Commercial Temperature |
| 89HPES24N3A1ZCBXG | 420-pin Green BX420 package, Commercial Temperature |



CORPORATE HEADQUARTERS
6024 Silver Creek Valley Road
San Jose, CA 95138

for SALES:
800-345-7015 or 408-284-8200
fax: 408-284-2775
www.idt.com

for Tech Support:
email: ssdhelp@idt.com
phone: 408-284-8208