

Features

- Low Turn-on Voltage
- Fast Switching
- PN Junction Guard Ring for Transient and ESD Protection
- Ultra-Small Surface Mount Package
- Also Available in Lead Free Version

Mechanical Data

- Case: SOT-523, Molded Plastic
- Case material - UL Flammability Rating 94V-0
- Moisture sensitivity: Level 1 per J-STD-020A
- Terminals: Solderable per MIL-STD-202, Method 208
- Also Available in Lead Free Plating (Matte Tin Finish). Please see Ordering Information, Note 4, on Page 3
- Polarity: See Diagrams Below
- Marking: See Diagrams Below & Page 2
- Weight: 0.002 grams (approx.)

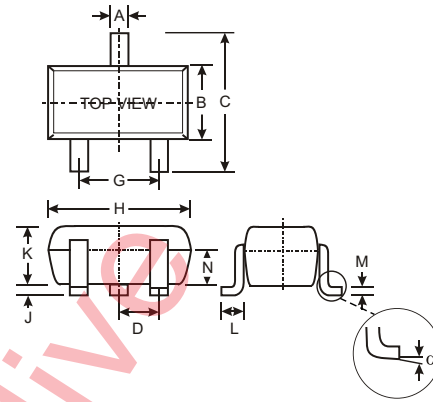

SOT-523			
Dim	Min	Max	Typ
A	0.15	0.30	0.22
B	0.75	0.85	0.80
C	1.45	1.75	1.60
D	—	—	0.50
G	0.90	1.10	1.00
H	1.50	1.70	1.60
J	0.00	0.10	0.05
K	0.60	0.80	0.75
L	0.10	0.30	0.22
M	0.10	0.20	0.12
N	0.45	0.65	0.50
α	0°	8°	—

All Dimensions in mm

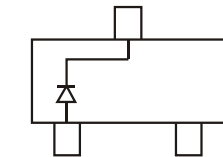

BAS70T Marking: 7C

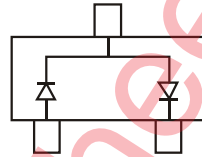

BAS70-04T Marking: 7D

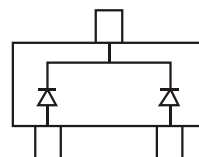

BAS70-05T Marking: 7E

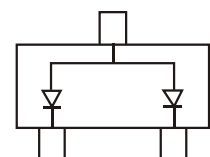

BAS70-06T Marking: 7F

Maximum Ratings and Electrical Characteristics, Single Diode @ $T_A = 25^\circ\text{C}$ unless otherwise specified

Characteristic	Symbol	Value	Unit
Peak Repetitive Reverse Voltage Working Peak Reverse Voltage DC Blocking Voltage	V_{RRM} V_{RWM} V_R	70	V
RMS Reverse Voltage	$V_{R(RMS)}$	49	V
Forward Continuous Current (Note 1)	I_{FM}	70	mA
Non-Repetitive Peak Forward Surge Current @ $t_p < 1.0\text{s}$	I_{FSM}	100	mA
Power Dissipation (Note 1)	P_d	150	mW
Thermal Resistance Junction to Ambient Air (Note 1)	$R_{\theta JA}$	833	$^\circ\text{C}/\text{W}$
Operating Temperature Range	T_j	-55 to +125	$^\circ\text{C}$
Storage Temperature Range	T_{STG}	-65 to +150	$^\circ\text{C}$

Electrical Ratings @ $T_A = 25^\circ\text{C}$ unless otherwise specified

Characteristic	Symbol	Min	Max	Unit	Test Condition
Reverse Breakdown Voltage (Note 2)	$V_{(BR)R}$	70	—	—	$I_R = 10\mu\text{A}$
Forward Voltage (Note 2)	V_F	—	410 1000	mV	$t_p < 300\mu\text{s}$, $I_F = 1.0\text{mA}$ $t_p < 300\mu\text{s}$, $I_F = 15\text{mA}$
Leakage Current (Note 2)	I_R	—	100	nA	$t_p < 300\mu\text{s}$, $V_R = 50\text{V}$
Total Capacitance	C_T	—	2.0	pF	$V_R = 0\text{V}$, $f = 1.0\text{MHz}$
Reverse Recovery Time	t_{rr}	—	5.0	ns	$I_F = I_R = 10\text{mA}$ to $I_R = 1.0\text{mA}$, $I_{rr} = 0.1 \times I_R$, $R_L = 100\Omega$

- Notes: 1. Device mounted on FR-4 PC board with recommended pad layout, which can be found on our website at <http://www.diodes.com/datasheets/ap02001.pdf>.
2. Short duration test pulse used to minimize self-heating effect.

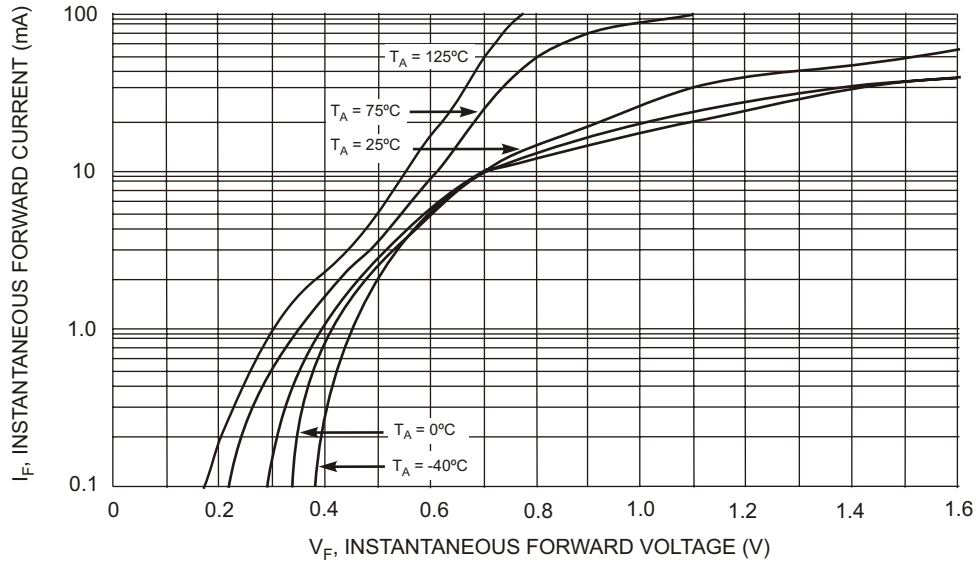

Fig. 1 Typical Forward Characteristics

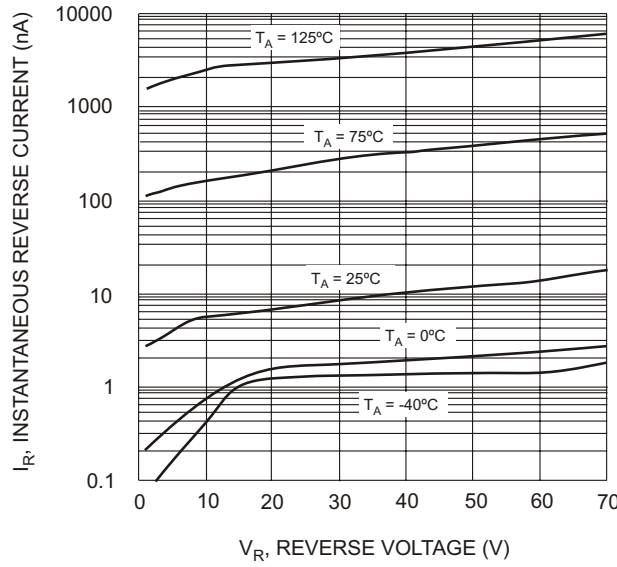

Fig. 2 Typical Reverse Characteristics

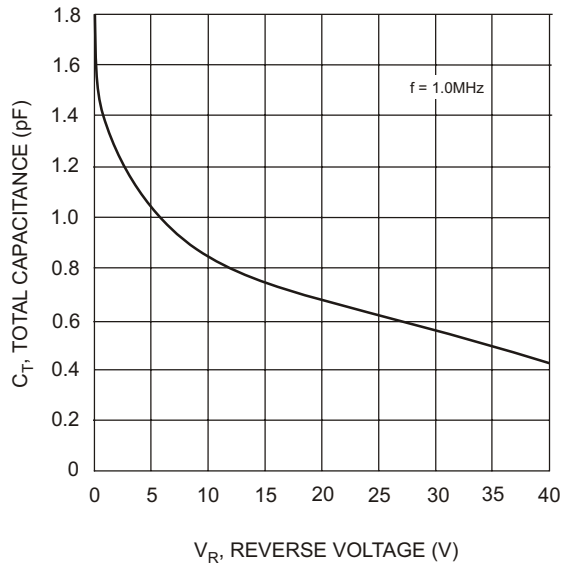

Fig. 3 Typical Capacitance

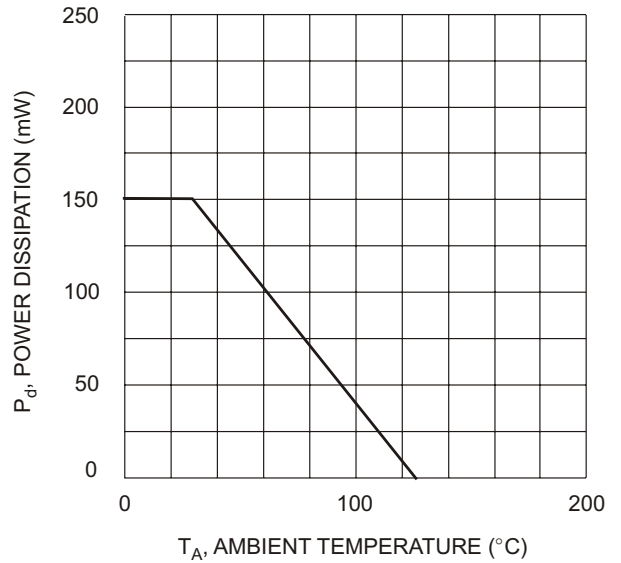

Fig. 4 Power Derating Curve, Total Package

Ordering Information (Note 3)

Device	Packaging	Shipping
BAS70T-7	SOT-523	3000/Tape & Reel
BAS70-04T-7	SOT-523	3000/Tape & Reel
BAS70-05T-7	SOT-523	3000/Tape & Reel
BAS70-06T-7	SOT-523	3000/Tape & Reel

- Notes: 3. For Packaging Details: go to our website at <http://www.diodes.com/datasheets/ap02007.pdf>.
 4. For Lead Free version (with Lead Free terminal finish) part number, please add "-F" suffix to part number above.
 Example: BAS70-06T-7-F.

Marking Information

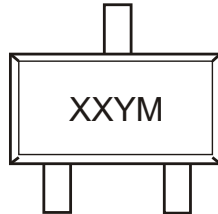

XX = Product Type Marking Code (See Page 1, e.g. 7C = BAS70T)
 YM = Date Code Marking
 Y = Year (ex: N = 2002)
 M = Month (ex: 9 = September)

Date Code Key

Year	2002	2003	2004	2005	2006	2007	2008	2009
Code	N	P	R	S	T	U	V	W

Month	Jan	Feb	March	Apr	May	Jun	Jul	Aug	Sep	Oct	Nov	Dec
Code	1	2	3	4	5	6	7	8	9	O	N	D