

# TPS77501, TPS77515, TPS77516, TPS77518, TPS77525, TPS77533 WITH RESET OUTPUT TPS77601, TPS77615, TPS77618, TPS77625, TPS77628, TPS77633 WITH PG OUTPUT FAST-TRANSIENT-RESPONSE 500-mA LOW-DROPOUT VOLTAGE REGULATORS

SLVS232H – SEPTEMBER 1999 – REVISED JUNE 2003

- Open Drain Power-On Reset With 200-ms Delay (TPS775xx)
- Open Drain Power Good (TPS776xx)
- 500-mA Low-Dropout Voltage Regulator
- Available in 1.5-V, 1.6-V (TPS77516 Only), 1.8-V, 2.5-V, 2.8-V (TPS77628 Only), 3.3-V Fixed Output and Adjustable Versions
- Dropout Voltage to 169 mV (Typ) at 500 mA (TPS77x33)
- Ultralow 85  $\mu$ A Typical Quiescent Current
- Fast Transient Response
- 2% Tolerance Over Specified Conditions for Fixed-Output Versions
- 8-Pin SOIC and 20-Pin TSSOP PowerPAD™ (PWP) Package
- Thermal Shutdown Protection

## description

The TPS775xx and TPS776xx devices are designed to have a fast transient response and be stable with a 10- $\mu$ F low ESR capacitors. This combination provides high performance at a reasonable cost.

PWP PACKAGE  
(TOP VIEW)

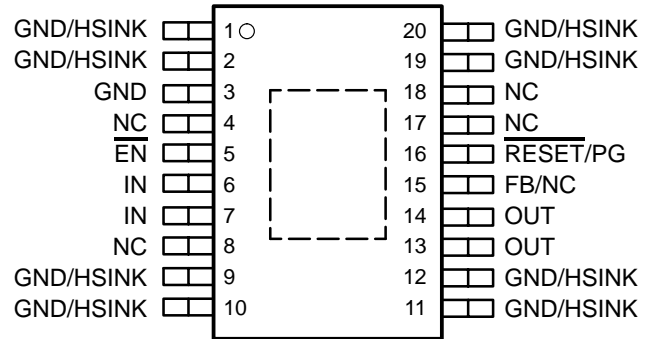

NC – No internal connection

D PACKAGE  
(TOP VIEW)

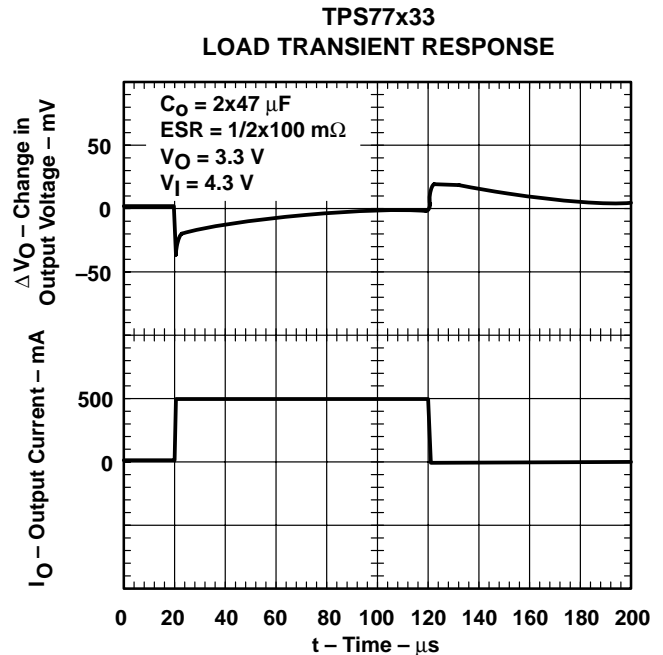
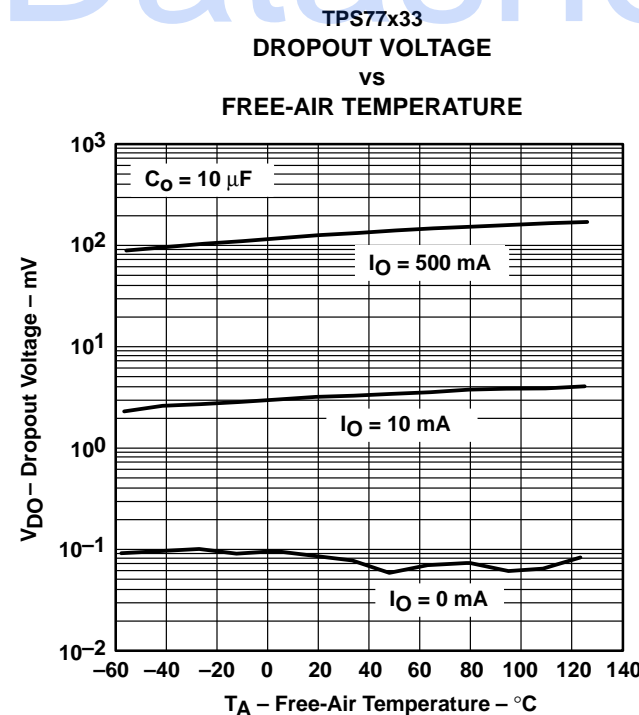
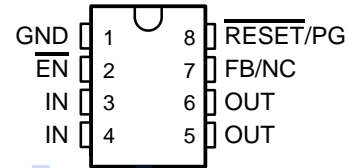

Please be aware that an important notice concerning availability, standard warranty, and use in critical applications of Texas Instruments semiconductor products and disclaimers thereto appears at the end of this data sheet.

PowerPAD is a trademark of Texas Instruments.

PRODUCTION DATA information is current as of publication date. Products conform to specifications per the terms of Texas Instruments standard warranty. Production processing does not necessarily include testing of all parameters.

**TEXAS  
INSTRUMENTS**

POST OFFICE BOX 655303 • DALLAS, TEXAS 75265

Copyright © 1999 – 2003, Texas Instruments Incorporated

# TPS77501, TPS77515, TPS77516, TPS77518, TPS77525, TPS77533 WITH $\overline{\text{RESET}}$ OUTPUT TPS77601, TPS77615, TPS77618, TPS77625, TPS77628, TPS77633 WITH PG OUTPUT FAST-TRANSIENT-RESPONSE 500-mA LOW-DROPOUT VOLTAGE REGULATORS

SLVS232H – SEPTEMBER 1999 – REVISED JUNE 2003

## description (continued)

Because the PMOS device behaves as a low-value resistor, the dropout voltage is very low (typically 169 mV at an output current of 500 mA for the TPS77x33) and is directly proportional to the output current. Additionally, since the PMOS pass element is a voltage-driven device, the quiescent current is very low and independent of output loading (typically 85  $\mu\text{A}$  over the full range of output current, 0 mA to 500 mA). These two key specifications yield a significant improvement in operating life for battery-powered systems. This LDO family also features a sleep mode; applying a TTL high signal to  $\overline{\text{EN}}$  (enable) shuts down the regulator, reducing the quiescent current to 1  $\mu\text{A}$  at  $T_J = 25^\circ\text{C}$ .

The  $\overline{\text{RESET}}$  output of the TPS775xx initiates a reset in microcomputer and microprocessor systems in the event of an undervoltage condition. An internal comparator in the TPS775xx monitors the output voltage of the regulator to detect an undervoltage condition on the regulated output voltage.

Power good (PG) of the TPS776xx is an active high output, which can be used to implement a power-on reset or a low-battery indicator.

The TPS775xx and TPS776xx are offered in 1.5-V, 1.6-V (TPS77516 only), 1.8-V, 2.5-V, 2.8 V (TPS77628 only), and 3.3-V fixed-voltage versions and in an adjustable version (programmable over the range of 1.5 V to 5.5 V for TPS77501 option and 1.2 V to 5.5 V for TPS77601 option). Output voltage tolerance is specified as a maximum of 2% over line, load, and temperature ranges. The TPS775xx and TPS776xx families are available in 8 pin SOIC and 20 pin TSSOP packages.

### AVAILABLE OPTIONS†

T <sub>J</sub>	OUTPUT VOLTAGE (V)	PACKAGED DEVICES			
	TYP	TSSOP (PWP)		SOIC (D)	
-40°C to 125°C	3.3	TPS77533PWP	TPS77633PWP	TPS77533D	TPS77633D
	2.5	TPS77525PWP	TPS77625PWP	TPS77525D	TPS77625D
	2.8	—	TPS77628PWP	—	TPS77628D
	1.8	TPS77518PWP	TPS77618PWP	TPS77518D	TPS77618D
	1.6	TPS77516PWP	—	TPS77516D	—
	1.5	TPS77515PWP	TPS77615PWP	TPS77515D	TPS77615D
	Adjustable‡ 1.2 V to 5.5 V	—	TPS77601PWP	—	TPS77601D
	Adjustable‡ 1.5 V to 5.5 V	TPS77501PWP	—	TPS77501D	—

† The TPS775xx has an open-drain power-on reset with a 200-ms delay function. The TPS776xx has an open-drain power good function.

‡ The TPS77x01 is programmable using an external resistor divider (see application information). The D and PWP packages are available taped and reeled. Add an R suffix to the device type (e.g., TPS77501DR).

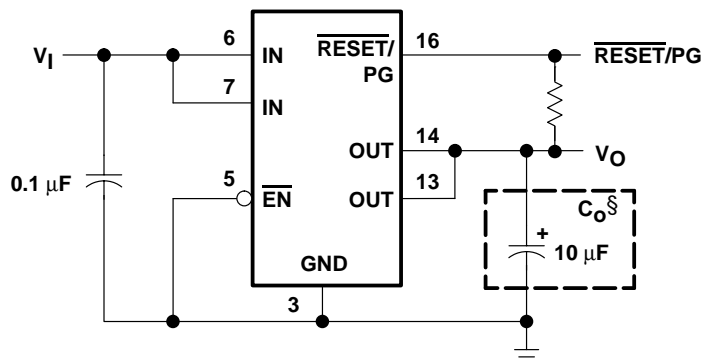

§ See application information section for capacitor selection details.

Figure 1. Typical Application Configuration for Fixed Output Options

TPS77501, TPS77515, TPS77516, TPS77518, TPS77525, TPS77533 WITH  $\overline{\text{RESET}}$  OUTPUT  
 TPS77601, TPS77615, TPS77618, TPS77625, TPS77628, TPS77633 WITH PG OUTPUT  
 FAST-TRANSIENT-RESPONSE 500-mA LOW-DROPOUT VOLTAGE REGULATORS

SLVS232H – SEPTEMBER 1999 – REVISED JUNE 2003

functional block diagram—adjustable version

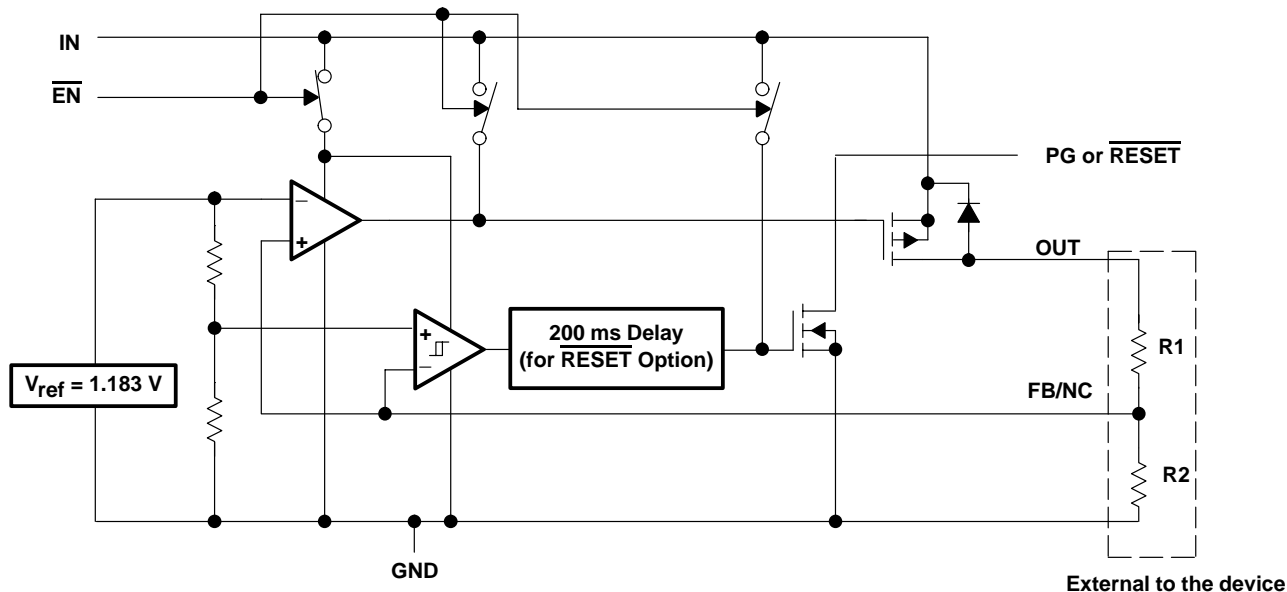

functional block diagram—fixed-voltage version

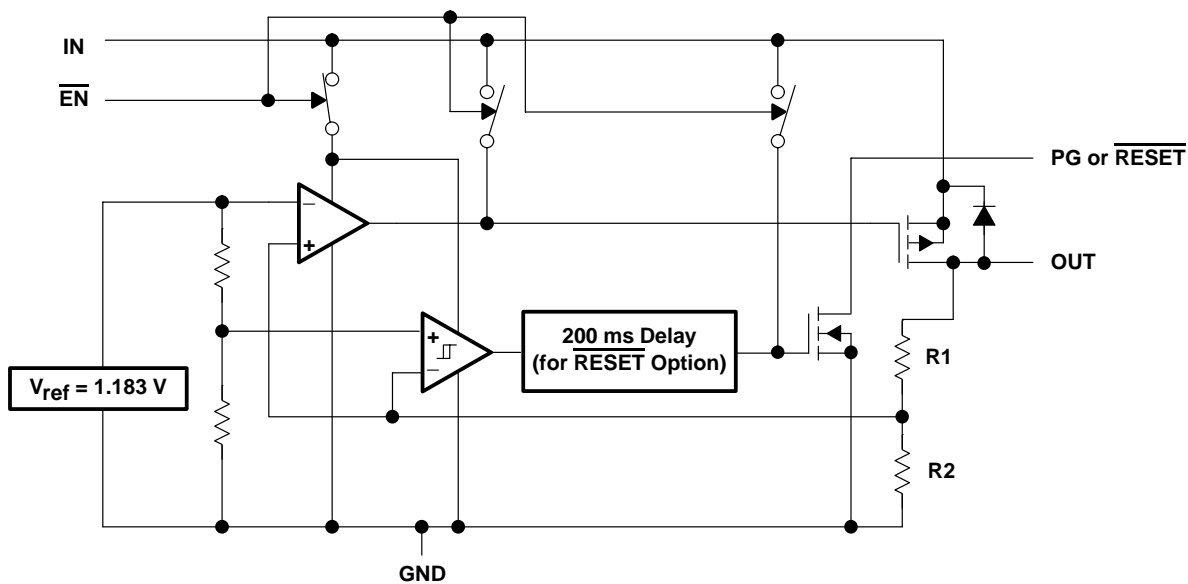

**TPS77501, TPS77515, TPS77516, TPS77518, TPS77525, TPS77533 WITH  $\overline{\text{RESET}}$  OUTPUT**  
**TPS77601, TPS77615, TPS77618, TPS77625, TPS77628, TPS77633 WITH PG OUTPUT**  
**FAST-TRANSIENT-RESPONSE 500-mA LOW-DROPOUT VOLTAGE REGULATORS**

SLVS232H – SEPTEMBER 1999 – REVISED JUNE 2003

**Terminal Functions**

**SOIC Package (TPS775xx)**

TERMINAL NAME	NO.	I/O	DESCRIPTION
$\overline{\text{EN}}$	2	I	Enable input
FB/NC	7	I	Feedback input voltage for adjustable device (no connect for fixed options)
GND	1		Regulator ground
IN	3, 4	I	Input voltage
OUT	5, 6	O	Regulated output voltage
$\overline{\text{RESET}}$	8	O	$\overline{\text{RESET}}$ output

**TSSOP Package (TPS775xx)**

TERMINAL NAME	NO.	I/O	DESCRIPTION
$\overline{\text{EN}}$	5	I	Enable input
FB/NC	15	I	Feedback input voltage for adjustable device (no connect for fixed options)
GND	3		Regulator ground
GND/HSINK	1, 2, 9, 10, 11, 12, 19, 20		Ground/heatsink
IN	6, 7	I	Input voltage
NC	4, 8, 17, 18		No connect
OUT	13, 14	O	Regulated output voltage
$\overline{\text{RESET}}$	16	O	$\overline{\text{RESET}}$ output

**SOIC Package (TPS776xx)**

TERMINAL NAME	NO.	I/O	DESCRIPTION
$\overline{\text{EN}}$	2	I	Enable input
FB/NC	7	I	Feedback input voltage for adjustable device (no connect for fixed options)
GND	1		Regulator ground
IN	3, 4	I	Input voltage
OUT	5, 6	O	Regulated output voltage
PG	8	O	PG output

**TSSOP Package (TPS776xx)**

TERMINAL NAME	NO.	I/O	DESCRIPTION
$\overline{\text{EN}}$	5	I	Enable input
FB/NC	15	I	Feedback input voltage for adjustable device (no connect for fixed options)
GND	3		Regulator ground
GND/HSINK	1, 2, 9, 10, 11, 12, 19, 20		Ground/heatsink
IN	6, 7	I	Input voltage
NC	4, 8, 17, 18		No connect
OUT	13, 14	O	Regulated output voltage
PG	16	O	PG output



TPS77501, TPS77515, TPS77516, TPS77518, TPS77525, TPS77533 WITH  $\overline{\text{RESET}}$  OUTPUT  
 TPS77601, TPS77615, TPS77618, TPS77625, TPS77628, TPS77633 WITH PG OUTPUT  
 FAST-TRANSIENT-RESPONSE 500-mA LOW-DROPOUT VOLTAGE REGULATORS

SLVS232H – SEPTEMBER 1999 – REVISED JUNE 2003

TPS775xx  $\overline{\text{RESET}}$  timing diagram

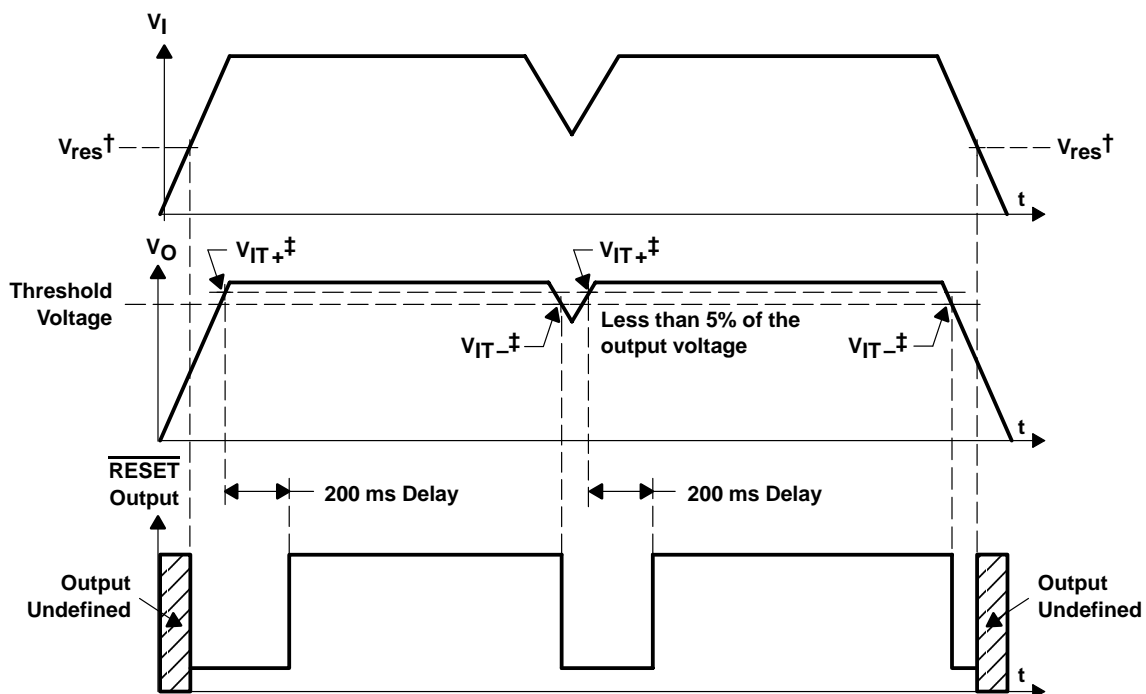

$^\dagger V_{res}$  is the minimum input voltage for a valid  $\overline{\text{RESET}}$ . The symbol  $V_{res}$  is not currently listed within EIA or JEDEC standards for semiconductor symbology.

$^\ddagger V_{IT-}$  – Trip voltage is typically 5% lower than the output voltage ( $95\%V_o$ ).  $V_{IT-}$  to  $V_{IT+}$  is the hysteresis voltage.

**TPS77501, TPS77515, TPS77516, TPS77518, TPS77525, TPS77533 WITH RESET OUTPUT**  
**TPS77601, TPS77615, TPS77618, TPS77625, TPS77628, TPS77633 WITH PG OUTPUT**  
**FAST-TRANSIENT-RESPONSE 500-mA LOW-DROPOUT VOLTAGE REGULATORS**

SLVS232H – SEPTEMBER 1999 – REVISED JUNE 2003

**absolute maximum ratings over operating free-air temperature range (unless otherwise noted)†**

Input voltage range‡, $V_I$ .....	-0.3 V to 13.5 V
Voltage range at $\overline{EN}$ .....	-0.3 V to 16.5 V
Maximum $\overline{RESET}$ voltage (TPS775xx) .....	16.5 V
Maximum PG voltage (TPS776xx) .....	16.5 V
Peak output current .....	Internally limited
Output voltage, $V_O$ (OUT, FB) .....	7 V
Continuous total power dissipation .....	See dissipation rating tables
Operating virtual junction temperature range, $T_J$ .....	-40°C to 125°C
Storage temperature range, $T_{stg}$ .....	-65°C to 150°C
ESD rating, HBM .....	2 kV

† Stresses beyond those listed under “absolute maximum ratings” may cause permanent damage to the device. These are stress ratings only, and functional operation of the device at these or any other conditions beyond those indicated under “recommended operating conditions” is not implied. Exposure to absolute-maximum-rated conditions for extended periods may affect device reliability.

‡ All voltage values are with respect to network terminal ground.

**DISSIPATION RATING TABLE 1 – FREE-AIR TEMPERATURES**

PACKAGE	AIR FLOW (CFM)	$T_A < 25^\circ\text{C}$ POWER RATING	DERATING FACTOR ABOVE $T_A = 25^\circ\text{C}$	$T_A = 70^\circ\text{C}$ POWER RATING	$T_A = 85^\circ\text{C}$ POWER RATING
D	0	568 mW	5.68 mW/°C	312 mW	227 mW
	250	904 mW	9.04 mW/°C	497 mW	361 mW

**DISSIPATION RATING TABLE 2 – FREE-AIR TEMPERATURES**

PACKAGE	AIR FLOW (CFM)	$T_A < 25^\circ\text{C}$ POWER RATING	DERATING FACTOR ABOVE $T_A = 25^\circ\text{C}$	$T_A = 70^\circ\text{C}$ POWER RATING	$T_A = 85^\circ\text{C}$ POWER RATING
PWP§	0	2.9 W	23.5 mW/°C	1.9 W	1.5 W
	300	4.3 W	34.6 mW/°C	2.8 W	2.2 W
PWP¶	0	3 W	23.8 mW/°C	1.9 W	1.5 W
	300	7.2 W	57.9 mW/°C	4.6 W	3.8 W

§ This parameter is measured with the recommended copper heat sink pattern on a 1-layer PCB, 5-in × 5-in PCB, 1 oz. copper, 2-in × 2-in coverage (4 in<sup>2</sup>).

¶ This parameter is measured with the recommended copper heat sink pattern on a 8-layer PCB, 1.5-in × 2-in PCB, 1 oz. copper with layers 1, 2, 4, 5, 7, and 8 at 5% coverage (0.9 in<sup>2</sup>) and layers 3 and 6 at 100% coverage (6 in<sup>2</sup>). For more information, refer to TI technical brief SLMA002.

**recommended operating conditions**

		MIN	MAX	UNIT
Input voltage, $V_I$ #		2.7	10	V
Output voltage range, $V_O$	TPS77501	1.5	5.5	V
	TPS77601	1.2	5.5	
Operating virtual junction temperature, $T_J$ (see Note 1)		-40	125	°C

# To calculate the minimum input voltage for your maximum output current, use the following equation:  $V_{I(\min)} = V_{O(\max)} + V_{DO(\max \text{ load})}$ .



**TPS77501, TPS77515, TPS77516, TPS77518, TPS77525, TPS77533 WITH RESET OUTPUT  
TPS77601, TPS77615, TPS77618, TPS77625, TPS77628, TPS77633 WITH PG OUTPUT  
FAST-TRANSIENT-RESPONSE 500-mA LOW-DROPOUT VOLTAGE REGULATORS**

SLVS232H – SEPTEMBER 1999 – REVISED JUNE 2003

**electrical characteristics over recommended operating temperature range (T<sub>J</sub> = –40°C to 125°C),  
V<sub>I</sub> = V<sub>O(typ)</sub> + 1 V, I<sub>O</sub> = 1 mA,  $\overline{EN}$  = 0 V, C<sub>O</sub> = 10 μF (unless otherwise noted)**

PARAMETER		TEST CONDITIONS	MIN	TYP	MAX	UNIT
Output voltage (10 μA to 500 mA load) (see Note 2)	TPS77501	1.5 V ≤ V <sub>O</sub> ≤ 5.5 V, T <sub>J</sub> = 25°C		V <sub>O</sub>		V
		1.5 V ≤ V <sub>O</sub> ≤ 5.5 V,	0.98V <sub>O</sub>		1.02V <sub>O</sub>	
	TPS77601	1.2 V ≤ V <sub>O</sub> ≤ 5.5 V, T <sub>J</sub> = 25°C		V <sub>O</sub>		
		1.2 V ≤ V <sub>O</sub> ≤ 5.5 V,	0.98V <sub>O</sub>		1.02V <sub>O</sub>	
	TPS77x15	T <sub>J</sub> = 25°C, 2.7 V < V <sub>IN</sub> < 10 V		1.5		
		T <sub>J</sub> = –40°C to 125°C, 2.7 V < V <sub>IN</sub> < 10 V	1.470		1.530	
	TPS77516	T <sub>J</sub> = 25°C, 2.7 V < V <sub>IN</sub> < 10 V		1.6		
		T <sub>J</sub> = –40°C to 125°C, 2.7 V < V <sub>IN</sub> < 10 V	1.568		1.632	
	TPS77x18	T <sub>J</sub> = 25°C, 2.8 V < V <sub>IN</sub> < 10 V		1.8		
		T <sub>J</sub> = –40°C to 125°C, 2.8 V < V <sub>IN</sub> < 10 V	1.764		1.836	
	TPS77x25	T <sub>J</sub> = 25°C, 3.5 V < V <sub>IN</sub> < 10 V		2.5		
		T <sub>J</sub> = –40°C to 125°C, 3.5 V < V <sub>IN</sub> < 10 V	2.450		2.550	
	TPS77628	T <sub>J</sub> = 25°C, 3.8 V < V <sub>IN</sub> < 10 V		2.8		
		T <sub>J</sub> = –40°C to 125°C, 3.8 V < V <sub>IN</sub> < 10 V	2.744		2.856	
	TPS77x33	T <sub>J</sub> = 25°C, 4.3 V < V <sub>IN</sub> < 10 V		3.3		
		T <sub>J</sub> = –40°C to 125°C, 4.3 V < V <sub>IN</sub> < 10 V	3.234		3.366	
Quiescent current (GND current) EN = 0V, (see Note 2)		10 μA < I <sub>O</sub> < 500 mA, T <sub>J</sub> = 25°C		85		μA
		I <sub>O</sub> = 500 mA, T <sub>J</sub> = –40°C to 125°C			125	
Output voltage line regulation (ΔV <sub>O</sub> /V <sub>O</sub> ) (see Notes 2 and 3)		V <sub>O</sub> + 1 V < V <sub>I</sub> ≤ 10 V, T <sub>J</sub> = 25°C		0.01		%/V
Load regulation				3		mV
Output noise voltage (TPS77x18)		BW = 200 Hz to 100 kHz, I <sub>C</sub> = 500 mA C <sub>O</sub> = 10 μF, T <sub>J</sub> = 25°C		53		μVrms
Output current limit		V <sub>O</sub> = 0 V	1.2	1.6	1.9	A
Thermal shutdown junction temperature				150		°C
Standby current		$\overline{EN}$ = V <sub>I</sub> , T <sub>J</sub> = 25°C, 2.7 V < V <sub>I</sub> < 10 V		1		μA
		$\overline{EN}$ = V <sub>I</sub> , 2.7 V < V <sub>I</sub> < 10 V			10	μA
FB input current	TPS77x01	FB = 1.5 V		2		nA
High level enable input voltage				1.7		V
Low level enable input voltage					0.9	V
Power supply ripple rejection (see Note 2)		f = 1 KHz, C <sub>O</sub> = 10 μF, T <sub>J</sub> = 25°C		60		dB

- NOTES: 1. Minimum IN operating voltage is 2.7 V or V<sub>O(typ)</sub> + 1 V, whichever is greater. Maximum IN voltage 10V.  
2. If V<sub>O</sub> ≤ 1.8 V then V<sub>Imin</sub> = 2.7 V, V<sub>Imax</sub> = 10 V:

$$\text{Line Reg. (mV)} = (\%/V) \times \frac{V_O(V_{I\max} - 2.7 V)}{100} \times 1000$$

If V<sub>O</sub> ≥ 2.5 V then V<sub>Imin</sub> = V<sub>O</sub> + 1 V, V<sub>Imax</sub> = 10 V:

$$\text{Line Reg. (mV)} = (\%/V) \times \frac{V_O(V_{I\max} - (V_O + 1 V))}{100} \times 1000$$



**TPS77501, TPS77515, TPS77516, TPS77518, TPS77525, TPS77533 WITH RESET OUTPUT**  
**TPS77601, TPS77615, TPS77618, TPS77625, TPS77628, TPS77633 WITH PG OUTPUT**  
**FAST-TRANSIENT-RESPONSE 500-mA LOW-DROPOUT VOLTAGE REGULATORS**

SLVS232H – SEPTEMBER 1999 – REVISED JUNE 2003

**electrical characteristics over recommended operating temperature range (T<sub>J</sub> = –40°C to 125°C),**  
**V<sub>I</sub> = V<sub>O</sub>(typ) + 1 V, I<sub>O</sub> = 1 mA,  $\overline{EN}$  = 0 V, C<sub>O</sub> = 10 μF (unless otherwise noted) (continued)**

PARAMETER		TEST CONDITIONS	MIN	TYP	MAX	UNIT
Reset (TPS775xx)	Minimum input voltage for valid $\overline{RESET}$	I <sub>O</sub> (RESET) = 300μA		1.1		V
	Trip threshold voltage	V <sub>O</sub> decreasing	92		98	%V <sub>O</sub>
	Hysteresis voltage	Measured at V <sub>O</sub>		0.5		%V <sub>O</sub>
	Output low voltage	V <sub>I</sub> = 2.7 V, I <sub>O</sub> (RESET) = 1 mA		0.15	0.4	V
	Leakage current	V(RESET) = 5 V			1	μA
	RESET time-out delay			200		ms
PG (TPS776xx)	Minimum input voltage for valid PG	I <sub>O</sub> (PG) = 300 μA		1.1		V
	Trip threshold voltage	V <sub>O</sub> decreasing	92		98	%V <sub>O</sub>
	Hysteresis voltage	Measured at V <sub>O</sub>		0.5		%V <sub>O</sub>
	Output low voltage	V <sub>I</sub> = 2.7 V, I <sub>O</sub> (PG) = 1 mA		0.15	0.4	V
	Leakage current	V(PG) = 5 V			1	μA
Input current ( $\overline{EN}$ )		$\overline{EN}$ = 0 V	–1	0	1	μA
		$\overline{EN}$ = V <sub>I</sub>	–1		1	
Dropout voltage (see Note 4)	TPS77628	I <sub>O</sub> = 500 mA, T <sub>J</sub> = 25°C		285		mV
		I <sub>O</sub> = 500 mA,			410	
	TPS77533	I <sub>O</sub> = 500 mA, T <sub>J</sub> = 25°C		169		
		I <sub>O</sub> = 500 mA,			287	
	TPS77633	I <sub>O</sub> = 500 mA, T <sub>J</sub> = 25°C		169		
		I <sub>O</sub> = 500 mA,			287	

NOTE 3: I<sub>N</sub> voltage equals V<sub>O</sub>(typ) – 100 mV; TPS77x15, TPS77516, TPS77x18, and TPS77x25 dropout voltage limited by input voltage range limitations (i.e., TPS77x33 input voltage needs to drop to 3.2 V for purpose of this test).

**TYPICAL CHARACTERISTICS**

**Table of Graphs**

		FIGURE
V <sub>O</sub>	Output voltage	vs Output current
		vs Free-air temperature
	Ground current	vs Free-air temperature
	Power supply ripple rejection	vs Frequency
	Output spectral noise density	vs Frequency
Z <sub>O</sub>	Output impedance	vs Frequency
V <sub>DO</sub>	Dropout voltage	vs Input voltage
		vs Free-air temperature
	Input voltage (min)	vs Output voltage
	Line transient response	
	Load transient response	
V <sub>O</sub>	Output voltage	vs Time
	Equivalent series resistance (ESR)	vs Output current





TYPICAL CHARACTERISTICS

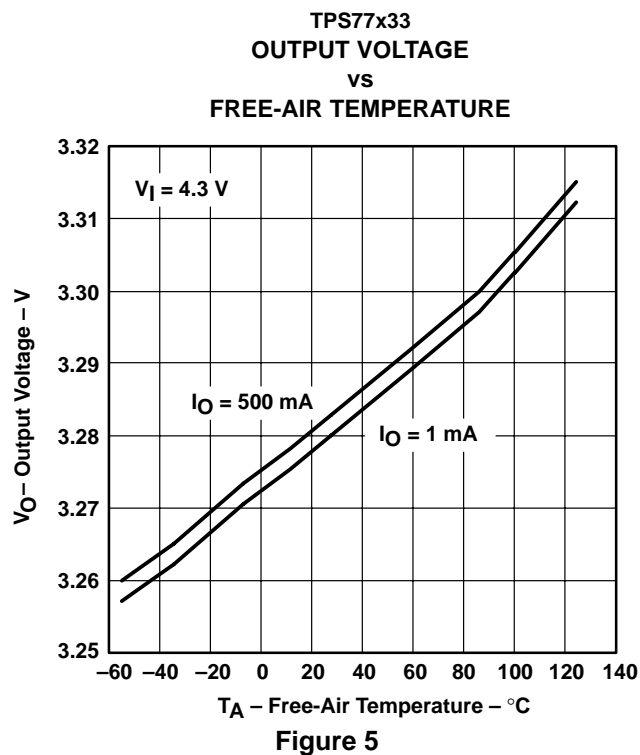
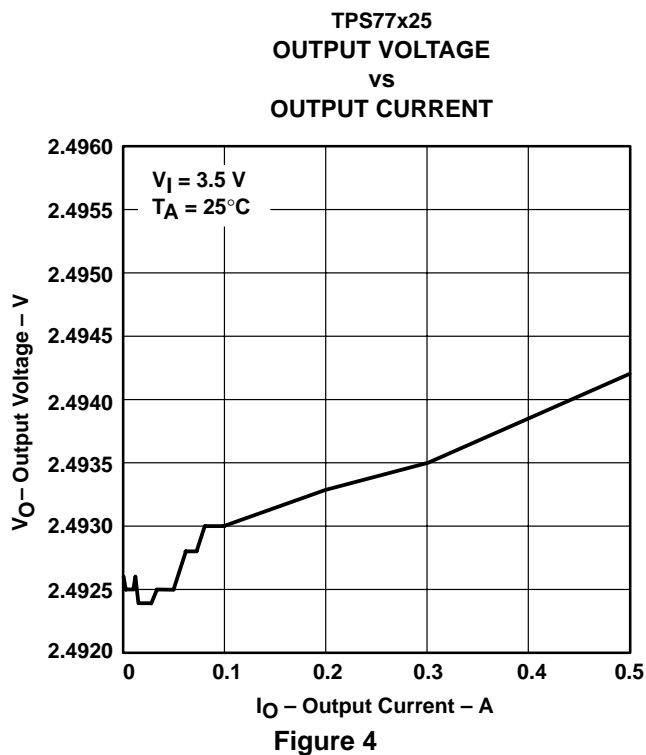
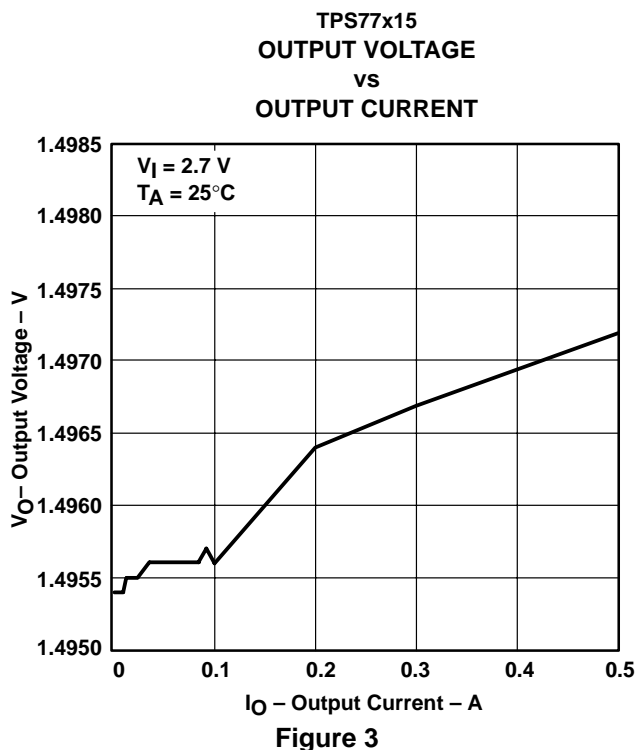
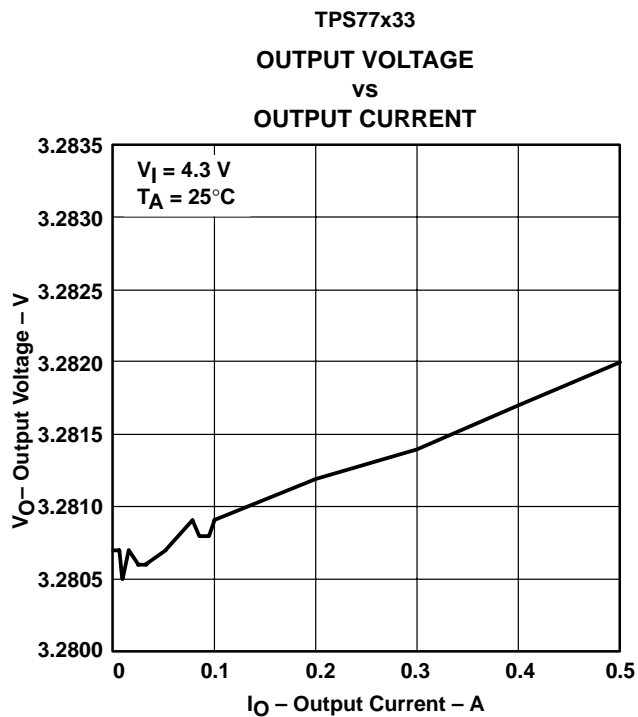

**TPS77501, TPS77515, TPS77516, TPS77518, TPS77525, TPS77533 WITH RESET OUTPUT**  
**TPS77601, TPS77615, TPS77618, TPS77625, TPS77628, TPS77633 WITH PG OUTPUT**  
**FAST-TRANSIENT-RESPONSE 500-mA LOW-DROPOUT VOLTAGE REGULATORS**

SLVS232H – SEPTEMBER 1999 – REVISED JUNE 2003

**TYPICAL CHARACTERISTICS**

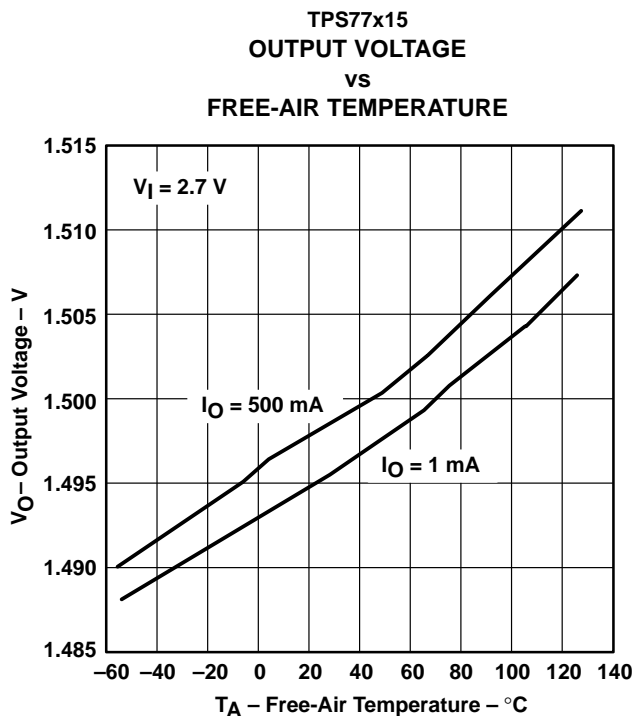

**Figure 6**

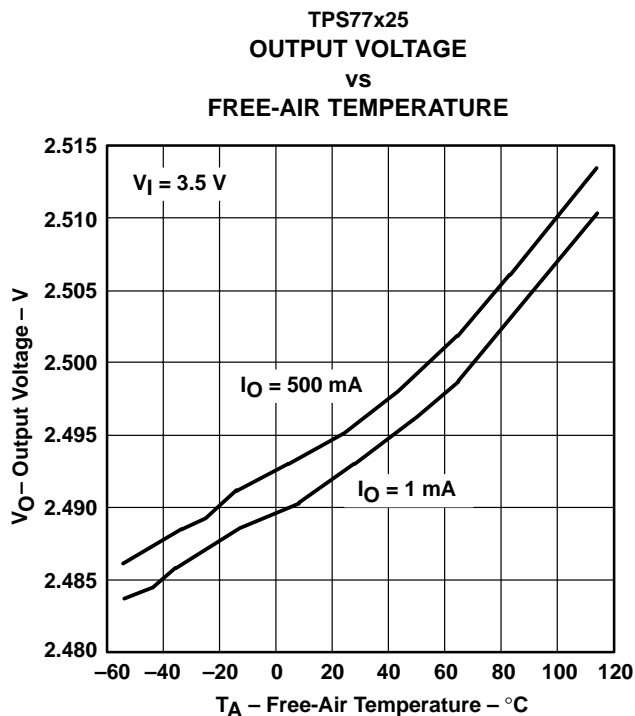

**Figure 7**

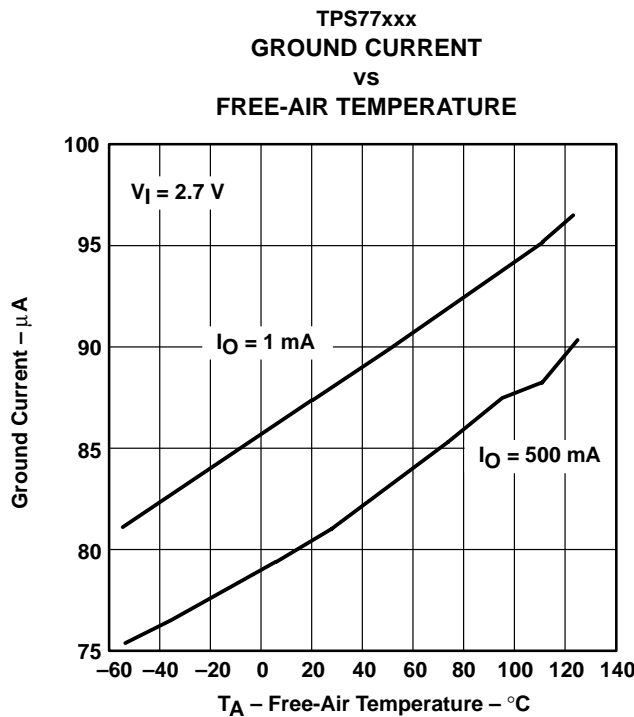

**Figure 8**

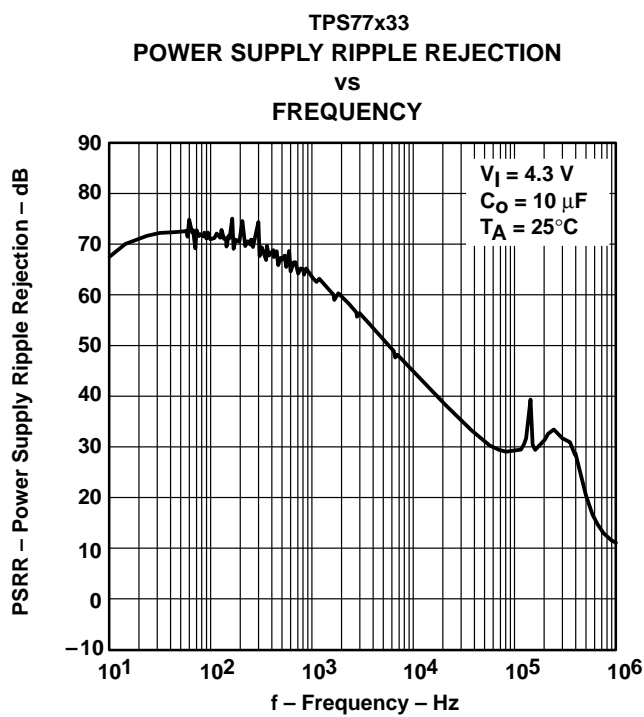

**Figure 9**



TYPICAL CHARACTERISTICS

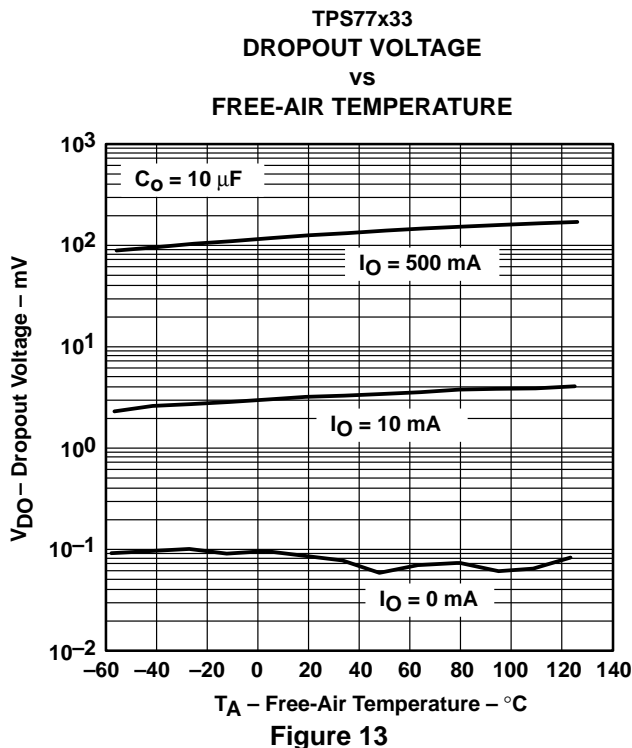
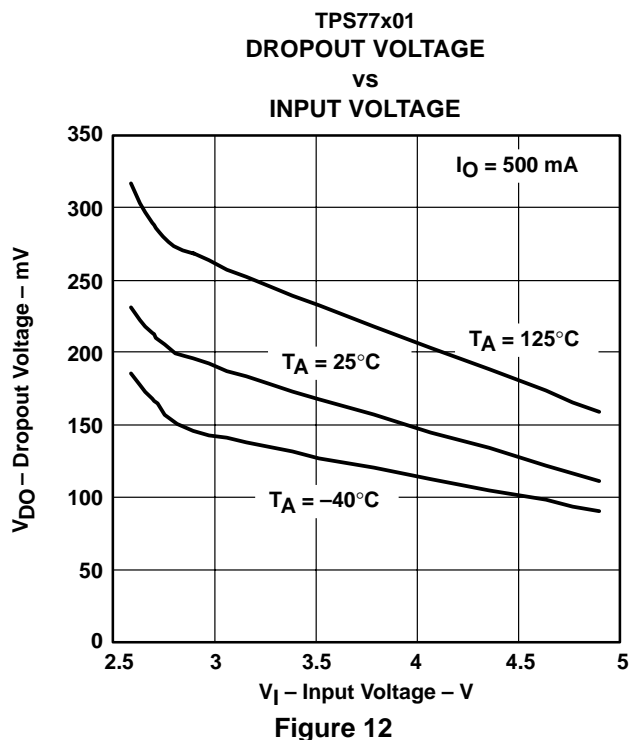
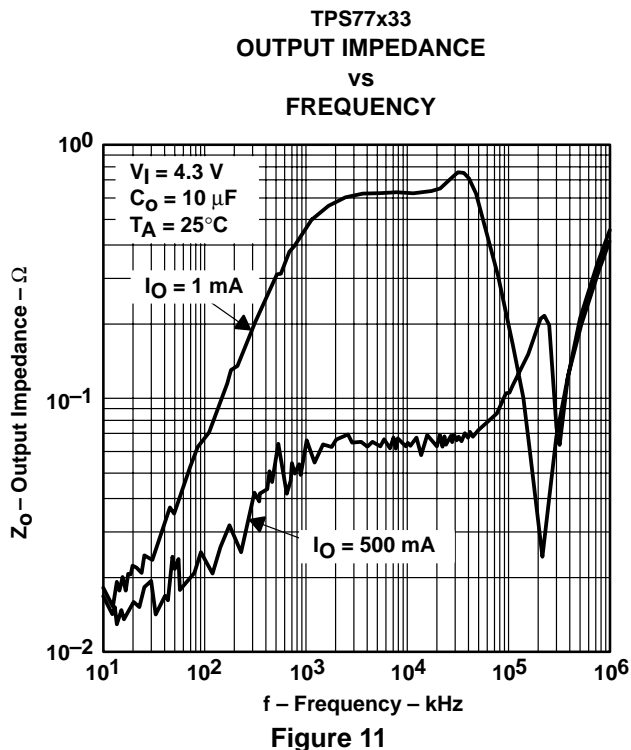
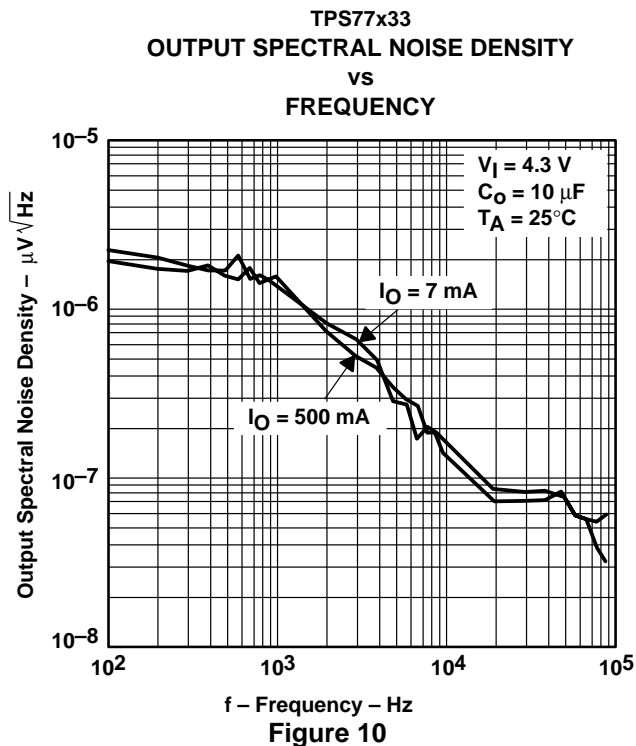

**TPS77501, TPS77515, TPS77516, TPS77518, TPS77525, TPS77533 WITH RESET OUTPUT**  
**TPS77601, TPS77615, TPS77618, TPS77625, TPS77628, TPS77633 WITH PG OUTPUT**  
**FAST-TRANSIENT-RESPONSE 500-mA LOW-DROPOUT VOLTAGE REGULATORS**

SLVS232H – SEPTEMBER 1999 – REVISED JUNE 2003

**TYPICAL CHARACTERISTICS**

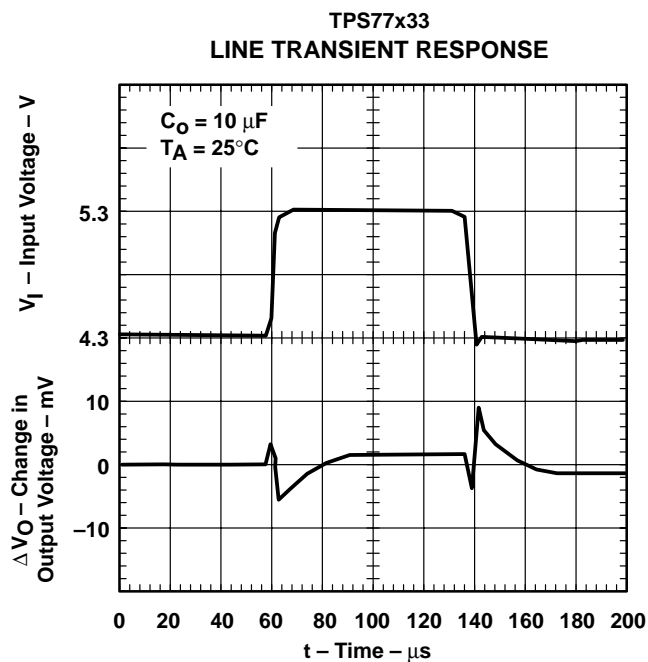
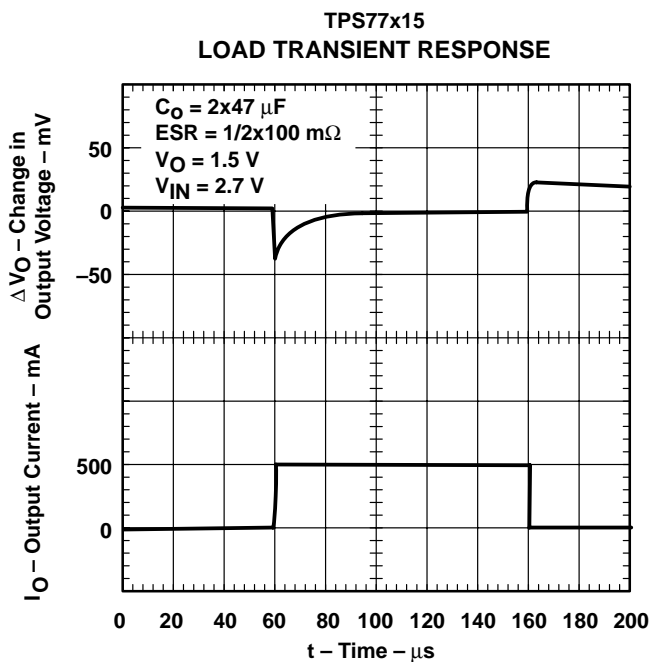
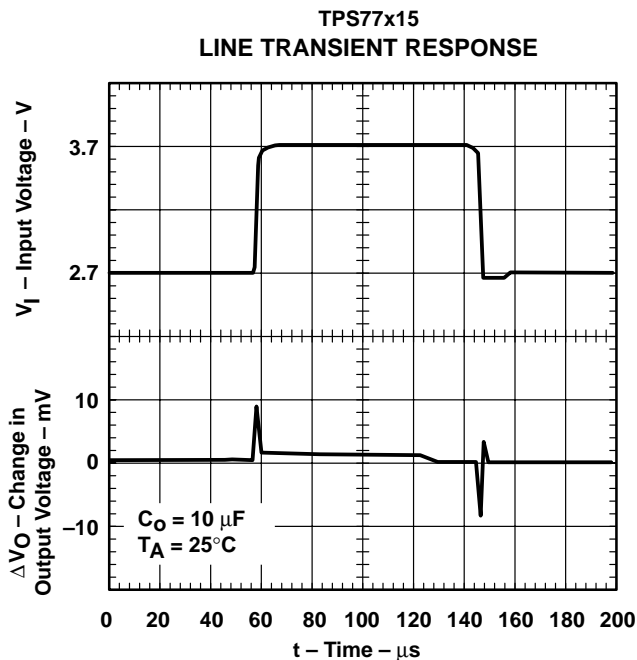
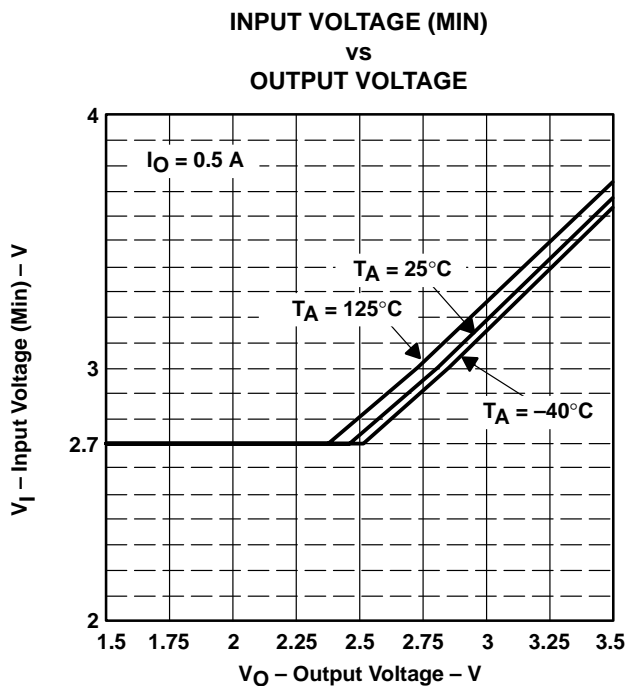

TYPICAL CHARACTERISTICS

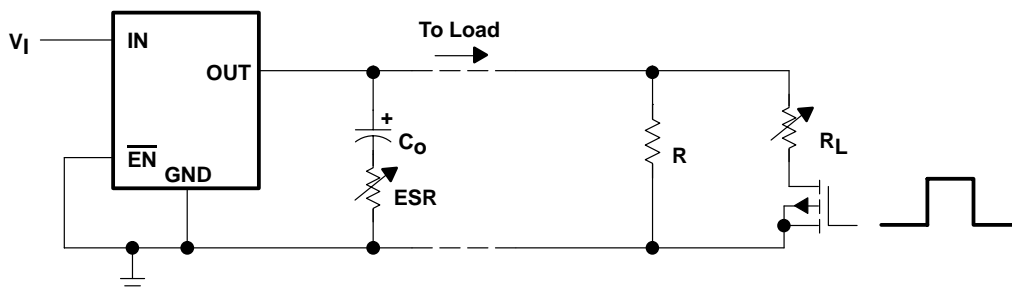
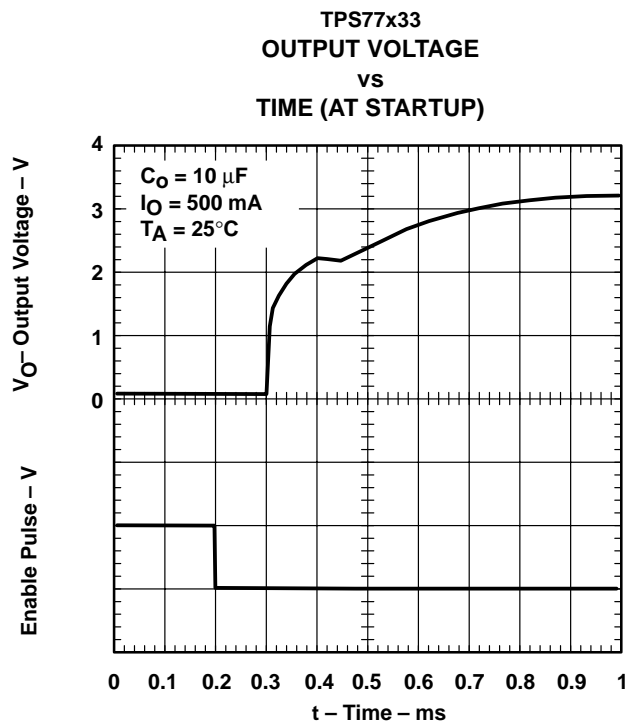
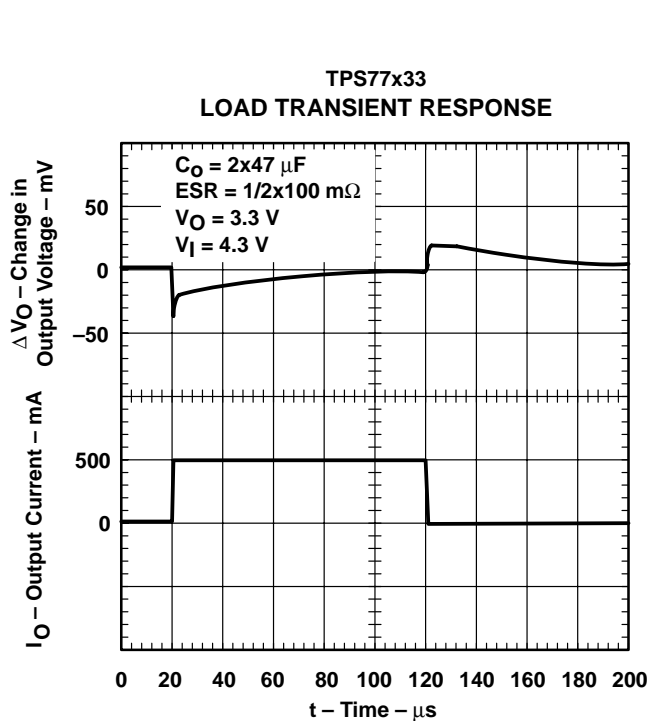

Figure 20. Test Circuit for Typical Regions of Stability (Figures 21 through 24) (Fixed Output Options)

**TPS77501, TPS77515, TPS77516, TPS77518, TPS77525, TPS77533 WITH RESET OUTPUT  
 TPS77601, TPS77615, TPS77618, TPS77625, TPS77628, TPS77633 WITH PG OUTPUT  
 FAST-TRANSIENT-RESPONSE 500-mA LOW-DROPOUT VOLTAGE REGULATORS**

SLVS232H – SEPTEMBER 1999 – REVISED JUNE 2003

**TYPICAL CHARACTERISTICS**

**TYPICAL REGION OF STABILITY  
 EQUIVALENT SERIES RESISTANCE†  
 VS  
 OUTPUT CURRENT**

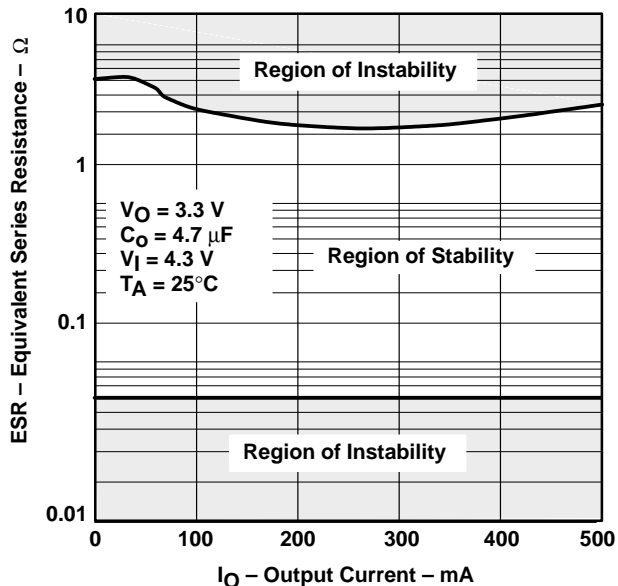

**Figure 21**

**TYPICAL REGION OF STABILITY  
 EQUIVALENT SERIES RESISTANCE†  
 VS  
 OUTPUT CURRENT**

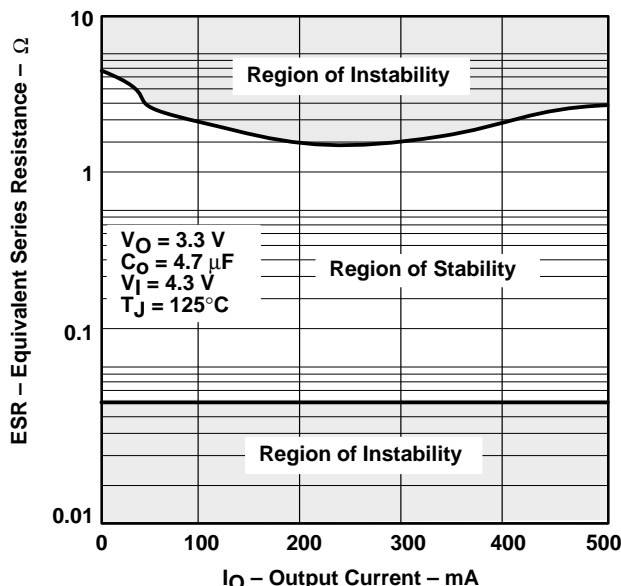

**Figure 22**

**TYPICAL REGION OF STABILITY  
 EQUIVALENT SERIES RESISTANCE†  
 VS  
 OUTPUT CURRENT**

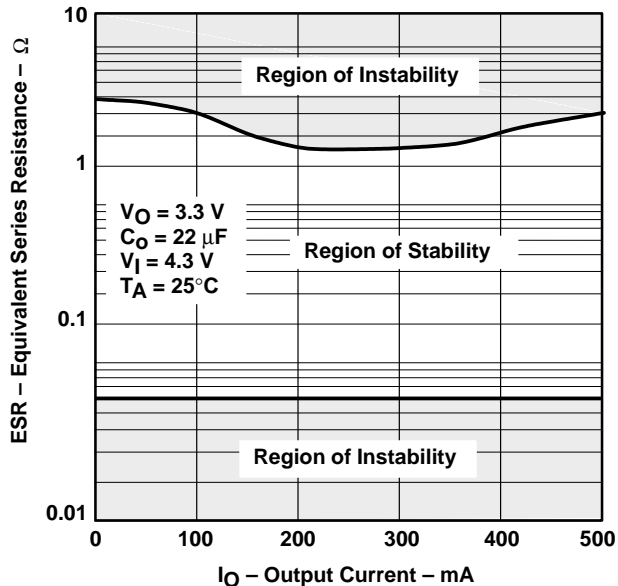

**Figure 23**

**TYPICAL REGION OF STABILITY  
 EQUIVALENT SERIES RESISTANCE†  
 VS  
 OUTPUT CURRENT**

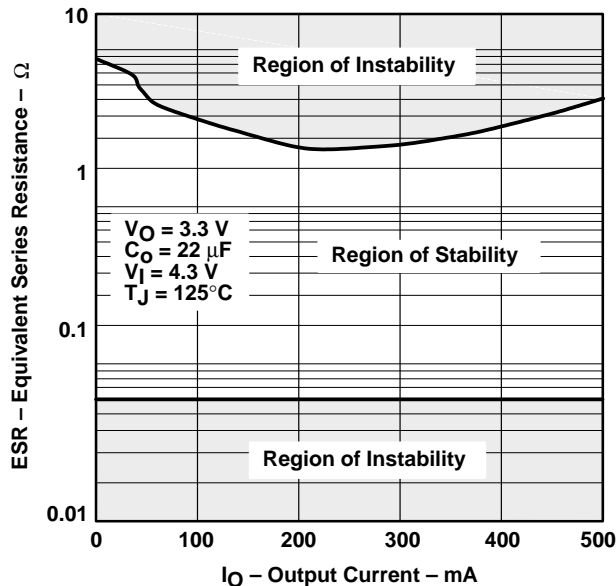

**Figure 24**

† Equivalent series resistance (ESR) refers to the total series resistance, including the ESR of the capacitor, any series resistance added externally, and PWB trace resistance to  $C_O$ .



## APPLICATION INFORMATION

The TPS775xx family includes five fixed-output voltage regulators (1.5 V, 1.6 V, 1.8 V, 2.5 V, and 3.3 V), and an adjustable regulator, the TPS77501 (adjustable from 1.5 V to 5.5 V).

The TPS776xx family includes five fixed-output voltage regulators (1.5 V, 1.8 V, 2.5 V, 2.8 V, and 3.3 V), and an adjustable regulator, the TPS77601 (adjustable from 1.2 V to 5.5 V).

### device operation

The TPS775xx and TPS776xx feature very low quiescent current, which remains virtually constant even with varying loads. Conventional LDO regulators use a pnp pass element, the base current of which is directly proportional to the load current through the regulator ( $I_B = I_C/\beta$ ). The TPS775xx and TPS776xx use a PMOS transistor to pass current; because the gate of the PMOS is voltage driven, operating current is low and invariable over the full load range.

Another pitfall associated with the pnp-pass element is its tendency to saturate when the device goes into dropout. The resulting drop in  $\beta$  forces an increase in  $I_B$  to maintain the load. During power up, this translates to large start-up currents. Systems with limited supply current may fail to start up. In battery-powered systems, it means rapid battery discharge when the voltage decays below the minimum required for regulation. The TPS775xx and TPS776xx quiescent currents remain low even when the regulator drops out, eliminating both problems.

The TPS775xx and TPS776xx families also feature a shutdown mode that places the output in the high-impedance state (essentially equal to the feedback-divider resistance) and reduces quiescent current to 2  $\mu$ A. If the shutdown feature is not used,  $\overline{EN}$  should be tied to ground.

### minimum load requirements

The TPS775xx and TPS776xx families are stable even at zero load; no minimum load is required for operation.

### FB—pin connection (adjustable version only)

The FB pin is an input pin to sense the output voltage and close the loop for the adjustable option. The output voltage is sensed through a resistor divider network to close the loop as it is shown in Figure 26. Normally, this connection should be as short as possible; however, the connection can be made near a critical circuit to improve performance at that point. Internally, FB connects to a high-impedance wide-bandwidth amplifier and noise pickup feeds through to the regulator output. Routing the FB connection to minimize/avoid noise pickup is essential.

### external capacitor requirements

An input capacitor is not usually required; however, a ceramic bypass capacitor (0.047  $\mu$ F or larger) improves load transient response and noise rejection if the TPS775xx or TPS776xx are located more than a few inches from the power supply. A higher-capacitance electrolytic capacitor may be necessary if large (hundreds of milliamps) load transients with fast rise times are anticipated.

Like all low dropout regulators, the TPS775xx and TPS776xx require an output capacitor connected between OUT and GND to stabilize the internal control loop. The minimum recommended capacitance value is 10  $\mu$ F and the ESR (equivalent series resistance) must be between 50 m $\Omega$  and 1.5  $\Omega$ . Capacitor values 10  $\mu$ F or larger are acceptable, provided the ESR is less than 1.5  $\Omega$ . Solid tantalum electrolytic, aluminum electrolytic, and multilayer ceramic capacitors are all suitable, provided they meet the requirements described previously.

**APPLICATION INFORMATION**

**external capacitor requirements (continued)**

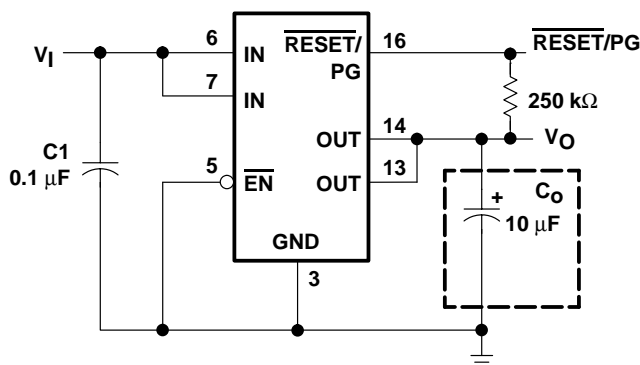

**Figure 25. Typical Application Circuit (Fixed Versions)**

**programming the TPS77x01 adjustable LDO regulator**

The output voltage of the TPS77x01 adjustable regulator is programmed using an external resistor divider as shown in Figure 26. The output voltage is calculated using:

$$V_O = V_{ref} \times \left(1 + \frac{R1}{R2}\right) \tag{1}$$

Where:

$$V_{ref} = 1.1834 \text{ V typ (the internal reference voltage)}$$

Resistors R1 and R2 should be chosen for approximately 10-μA divider current. Lower value resistors can be used but offer no inherent advantage and waste more power. Higher values should be avoided as leakage currents at FB increase the output voltage error. The recommended design procedure is to choose R2 = 110 kΩ to set the divider current at approximately 10 μA and then calculate R1 using:

$$R1 = \left(\frac{V_O}{V_{ref}} - 1\right) \times R2 \tag{2}$$

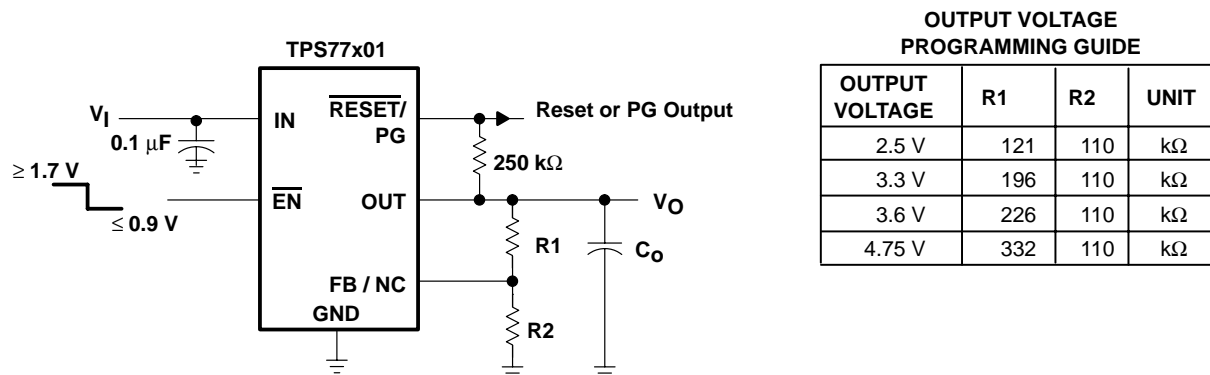

**Figure 26. TPS77x01 Adjustable LDO Regulator Programming**



---

## APPLICATION INFORMATION

### reset indicator

The TPS775xx features a  $\overline{\text{RESET}}$  output that can be used to monitor the status of the regulator. The internal comparator monitors the output voltage: when the output drops to between 92% and 98% of its nominal regulated value, the  $\overline{\text{RESET}}$  output transistor turns on, taking the signal low. The open-drain output requires a pullup resistor. If not used, it can be left floating.  $\overline{\text{RESET}}$  can be used to drive power-on reset circuitry or as a low-battery indicator.  $\overline{\text{RESET}}$  does not assert itself when the regulated output voltage falls outside the specified 2% tolerance, but instead reports an output voltage low relative to its nominal regulated value (refer to timing diagram for start-up sequence).

### power-good indicator

The TPS776xx features a power-good (PG) output that can be used to monitor the status of the regulator. The internal comparator monitors the output voltage: when the output drops to between 92% and 98% of its nominal regulated value, the PG output transistor turns on, taking the signal low. The open-drain output requires a pullup resistor. If not used, it can be left floating. PG can be used to drive power-on reset circuitry or used as a low-battery indicator.

### regulator protection

The TPS775xx and TPS776xx PMOS-pass transistors have a built-in back diode that conducts reverse currents when the input voltage drops below the output voltage (e.g., during power down). Current is conducted from the output to the input and is not internally limited. When extended reverse voltage is anticipated, external limiting may be appropriate.

The TPS775xx and TPS776xx also feature internal current limiting and thermal protection. During normal operation, the TPS775xx and TPS776xx limit output current to approximately 1.7 A. When current limiting engages, the output voltage scales back linearly until the overcurrent condition ends. While current limiting is designed to prevent gross device failure, care should be taken not to exceed the power dissipation ratings of the package. If the temperature of the device exceeds 150°C(typ), thermal-protection circuitry shuts it down. Once the device has cooled below 130°C(typ), regulator operation resumes.

**TPS77501, TPS77515, TPS77516, TPS77518, TPS77525, TPS77533 WITH RESET OUTPUT  
TPS77601, TPS77615, TPS77618, TPS77625, TPS77628, TPS77633 WITH PG OUTPUT  
FAST-TRANSIENT-RESPONSE 500-mA LOW-DROPOUT VOLTAGE REGULATORS**

SLVS232H – SEPTEMBER 1999 – REVISED JUNE 2003

---

**APPLICATION INFORMATION**

**power dissipation and junction temperature**

Specified regulator operation is assured to a junction temperature of 125°C; the maximum junction temperature should be restricted to 125°C under normal operating conditions. This restriction limits the power dissipation the regulator can handle in any given application. To ensure the junction temperature is within acceptable limits, calculate the maximum allowable dissipation,  $P_{D(max)}$ , and the actual dissipation,  $P_D$ , which must be less than or equal to  $P_{D(max)}$ .

The maximum-power-dissipation limit is determined using the following equation:

$$P_{D(max)} = \frac{T_{Jmax} - T_A}{R_{\theta JA}}$$

Where:

$T_{Jmax}$  is the maximum allowable junction temperature.

$R_{\theta JA}$  is the thermal resistance junction-to-ambient for the package, and is calculated as

$$\frac{1}{\text{derating factor}} \quad \text{from the dissipation rating tables.}$$

$T_A$  is the ambient temperature.

The regulator dissipation is calculated using:

$$P_D = (V_I - V_O) \times I_O$$

Power dissipation resulting from quiescent current is negligible. Excessive power dissipation will trigger the thermal protection circuit.



POST OFFICE BOX 655303 • DALLAS, TEXAS 75265

**PACKAGING INFORMATION**

Orderable Device	Status <sup>(1)</sup>	Package Type	Package Drawing	Pins	Package Qty	Eco Plan <sup>(2)</sup>	Lead/Ball Finish	MSL Peak Temp <sup>(3)</sup>
TPS77501D	ACTIVE	SOIC	D	8	75	Green (RoHS & no Sb/Br)	CU NIPDAU	Level-1-260C-UNLIM
TPS77501DR	ACTIVE	SOIC	D	8	2500	Green (RoHS & no Sb/Br)	CU NIPDAU	Level-1-260C-UNLIM
TPS77501DRG4	ACTIVE	SOIC	D	8	2500	Green (RoHS & no Sb/Br)	CU NIPDAU	Level-1-260C-UNLIM
TPS77501PWP	ACTIVE	HTSSOP	PWP	20	70	Green (RoHS & no Sb/Br)	CU NIPDAU	Level-2-260C-1 YEAR
TPS77501PWPR	ACTIVE	HTSSOP	PWP	20	2000	Green (RoHS & no Sb/Br)	CU NIPDAU	Level-2-260C-1 YEAR
TPS77501PWPRG4	ACTIVE	HTSSOP	PWP	20	2000	Green (RoHS & no Sb/Br)	CU NIPDAU	Level-2-260C-1 YEAR
TPS77515D	ACTIVE	SOIC	D	8	75	Green (RoHS & no Sb/Br)	CU NIPDAU	Level-1-260C-UNLIM
TPS77515DG4	ACTIVE	SOIC	D	8	75	Green (RoHS & no Sb/Br)	CU NIPDAU	Level-1-260C-UNLIM
TPS77515DR	ACTIVE	SOIC	D	8	2500	Green (RoHS & no Sb/Br)	CU NIPDAU	Level-1-260C-UNLIM
TPS77515DRG4	ACTIVE	SOIC	D	8	2500	Green (RoHS & no Sb/Br)	CU NIPDAU	Level-1-260C-UNLIM
TPS77515PWP	ACTIVE	HTSSOP	PWP	20	70	Green (RoHS & no Sb/Br)	CU NIPDAU	Level-2-260C-1 YEAR
TPS77515PWPG4	ACTIVE	HTSSOP	PWP	20	70	Green (RoHS & no Sb/Br)	CU NIPDAU	Level-2-260C-1 YEAR
TPS77515PWPR	ACTIVE	HTSSOP	PWP	20	2000	Green (RoHS & no Sb/Br)	CU NIPDAU	Level-2-260C-1 YEAR
TPS77515PWPRG4	ACTIVE	HTSSOP	PWP	20	2000	Green (RoHS & no Sb/Br)	CU NIPDAU	Level-2-260C-1 YEAR
TPS77516D	ACTIVE	SOIC	D	8	75	Green (RoHS & no Sb/Br)	CU NIPDAU	Level-1-260C-UNLIM
TPS77516DR	ACTIVE	SOIC	D	8	2500	Green (RoHS & no Sb/Br)	CU NIPDAU	Level-1-260C-UNLIM
TPS77516DRG4	ACTIVE	SOIC	D	8	2500	Green (RoHS & no Sb/Br)	CU NIPDAU	Level-1-260C-UNLIM
TPS77516PWP	ACTIVE	HTSSOP	PWP	20	70	Green (RoHS & no Sb/Br)	CU NIPDAU	Level-2-260C-1 YEAR
TPS77516PWPR	ACTIVE	HTSSOP	PWP	20	2000	Green (RoHS & no Sb/Br)	CU NIPDAU	Level-2-260C-1 YEAR
TPS77516PWPRG4	ACTIVE	HTSSOP	PWP	20	2000	Green (RoHS & no Sb/Br)	CU NIPDAU	Level-2-260C-1 YEAR
TPS77518D	ACTIVE	SOIC	D	8	75	Green (RoHS & no Sb/Br)	CU NIPDAU	Level-1-260C-UNLIM
TPS77518DG4	ACTIVE	SOIC	D	8	75	Green (RoHS & no Sb/Br)	CU NIPDAU	Level-1-260C-UNLIM
TPS77518DR	ACTIVE	SOIC	D	8	2500	Green (RoHS & no Sb/Br)	CU NIPDAU	Level-1-260C-UNLIM
TPS77518DRG4	ACTIVE	SOIC	D	8	2500	Green (RoHS & no Sb/Br)	CU NIPDAU	Level-1-260C-UNLIM
TPS77518PWP	ACTIVE	HTSSOP	PWP	20	70	Green (RoHS & no Sb/Br)	CU NIPDAU	Level-2-260C-1 YEAR

Orderable Device	Status <sup>(1)</sup>	Package Type	Package Drawing	Pins	Package Qty	Eco Plan <sup>(2)</sup>	Lead/Ball Finish	MSL Peak Temp <sup>(3)</sup>
TPS77518PWPR	ACTIVE	HTSSOP	PWP	20	2000	Green (RoHS & no Sb/Br)	CU NIPDAU	Level-2-260C-1 YEAR
TPS77518PWPRG4	ACTIVE	HTSSOP	PWP	20	2000	Green (RoHS & no Sb/Br)	CU NIPDAU	Level-2-260C-1 YEAR
TPS77525D	ACTIVE	SOIC	D	8	75	Green (RoHS & no Sb/Br)	CU NIPDAU	Level-1-260C-UNLIM
TPS77525DR	ACTIVE	SOIC	D	8	2500	Green (RoHS & no Sb/Br)	CU NIPDAU	Level-1-260C-UNLIM
TPS77525DRG4	ACTIVE	SOIC	D	8	2500	Green (RoHS & no Sb/Br)	CU NIPDAU	Level-1-260C-UNLIM
TPS77525PWP	ACTIVE	HTSSOP	PWP	20	70	Green (RoHS & no Sb/Br)	CU NIPDAU	Level-2-260C-1 YEAR
TPS77525PWPR	ACTIVE	HTSSOP	PWP	20	2000	Green (RoHS & no Sb/Br)	CU NIPDAU	Level-2-260C-1 YEAR
TPS77525PWPRG4	ACTIVE	HTSSOP	PWP	20	2000	Green (RoHS & no Sb/Br)	CU NIPDAU	Level-2-260C-1 YEAR
TPS77533D	ACTIVE	SOIC	D	8	75	Green (RoHS & no Sb/Br)	CU NIPDAU	Level-1-260C-UNLIM
TPS77533DG4	ACTIVE	SOIC	D	8	75	Green (RoHS & no Sb/Br)	CU NIPDAU	Level-1-260C-UNLIM
TPS77533DR	ACTIVE	SOIC	D	8	2500	Green (RoHS & no Sb/Br)	CU NIPDAU	Level-1-260C-UNLIM
TPS77533DRG4	ACTIVE	SOIC	D	8	2500	Green (RoHS & no Sb/Br)	CU NIPDAU	Level-1-260C-UNLIM
TPS77533PWP	ACTIVE	HTSSOP	PWP	20	70	Green (RoHS & no Sb/Br)	CU NIPDAU	Level-2-260C-1 YEAR
TPS77533PWPG4	ACTIVE	HTSSOP	PWP	20	70	Green (RoHS & no Sb/Br)	CU NIPDAU	Level-2-260C-1 YEAR
TPS77533PWPR	ACTIVE	HTSSOP	PWP	20	2000	Green (RoHS & no Sb/Br)	CU NIPDAU	Level-2-260C-1 YEAR
TPS77533PWPRG4	ACTIVE	HTSSOP	PWP	20	2000	Green (RoHS & no Sb/Br)	CU NIPDAU	Level-2-260C-1 YEAR
TPS77601D	ACTIVE	SOIC	D	8	75	Green (RoHS & no Sb/Br)	CU NIPDAU	Level-1-260C-UNLIM
TPS77601DG4	ACTIVE	SOIC	D	8	75	Green (RoHS & no Sb/Br)	CU NIPDAU	Level-1-260C-UNLIM
TPS77601DR	ACTIVE	SOIC	D	8	2500	Green (RoHS & no Sb/Br)	CU NIPDAU	Level-1-260C-UNLIM
TPS77601DRG4	ACTIVE	SOIC	D	8	2500	Green (RoHS & no Sb/Br)	CU NIPDAU	Level-1-260C-UNLIM
TPS77601PWP	ACTIVE	HTSSOP	PWP	20	70	Green (RoHS & no Sb/Br)	CU NIPDAU	Level-2-260C-1 YEAR
TPS77601PWPG4	ACTIVE	HTSSOP	PWP	20	70	Green (RoHS & no Sb/Br)	CU NIPDAU	Level-2-260C-1 YEAR
TPS77601PWPR	ACTIVE	HTSSOP	PWP	20	2000	Green (RoHS & no Sb/Br)	CU NIPDAU	Level-2-260C-1 YEAR
TPS77601PWPRG4	ACTIVE	HTSSOP	PWP	20	2000	Green (RoHS & no Sb/Br)	CU NIPDAU	Level-2-260C-1 YEAR
TPS77615D	ACTIVE	SOIC	D	8	75	Green (RoHS & no Sb/Br)	CU NIPDAU	Level-1-260C-UNLIM
TPS77615DG4	ACTIVE	SOIC	D	8	75	Green (RoHS & no Sb/Br)	CU NIPDAU	Level-1-260C-UNLIM

Orderable Device	Status <sup>(1)</sup>	Package Type	Package Drawing	Pins	Package Qty	Eco Plan <sup>(2)</sup>	Lead/Ball Finish	MSL Peak Temp <sup>(3)</sup>
TPS77615DR	ACTIVE	SOIC	D	8	2500	Green (RoHS & no Sb/Br)	CU NIPDAU	Level-1-260C-UNLIM
TPS77615DRG4	ACTIVE	SOIC	D	8	2500	Green (RoHS & no Sb/Br)	CU NIPDAU	Level-1-260C-UNLIM
TPS77615PWP	ACTIVE	HTSSOP	PWP	20	70	Green (RoHS & no Sb/Br)	CU NIPDAU	Level-2-260C-1 YEAR
TPS77615PWPG4	ACTIVE	HTSSOP	PWP	20	70	Green (RoHS & no Sb/Br)	CU NIPDAU	Level-2-260C-1 YEAR
TPS77615PWPR	ACTIVE	HTSSOP	PWP	20	2000	Green (RoHS & no Sb/Br)	CU NIPDAU	Level-2-260C-1 YEAR
TPS77615PWPRG4	ACTIVE	HTSSOP	PWP	20	2000	Green (RoHS & no Sb/Br)	CU NIPDAU	Level-2-260C-1 YEAR
TPS77618D	ACTIVE	SOIC	D	8	75	Green (RoHS & no Sb/Br)	CU NIPDAU	Level-1-260C-UNLIM
TPS77618DG4	ACTIVE	SOIC	D	8	75	Green (RoHS & no Sb/Br)	CU NIPDAU	Level-1-260C-UNLIM
TPS77618DR	ACTIVE	SOIC	D	8	2500	Green (RoHS & no Sb/Br)	CU NIPDAU	Level-1-260C-UNLIM
TPS77618DRG4	ACTIVE	SOIC	D	8	2500	Green (RoHS & no Sb/Br)	CU NIPDAU	Level-1-260C-UNLIM
TPS77618PWP	ACTIVE	HTSSOP	PWP	20	70	Green (RoHS & no Sb/Br)	CU NIPDAU	Level-2-260C-1 YEAR
TPS77618PWPG4	ACTIVE	HTSSOP	PWP	20	70	Green (RoHS & no Sb/Br)	CU NIPDAU	Level-2-260C-1 YEAR
TPS77618PWPR	ACTIVE	HTSSOP	PWP	20	2000	Green (RoHS & no Sb/Br)	CU NIPDAU	Level-2-260C-1 YEAR
TPS77618PWPRG4	ACTIVE	HTSSOP	PWP	20	2000	Green (RoHS & no Sb/Br)	CU NIPDAU	Level-2-260C-1 YEAR
TPS77625D	ACTIVE	SOIC	D	8	75	Green (RoHS & no Sb/Br)	CU NIPDAU	Level-1-260C-UNLIM
TPS77625DG4	ACTIVE	SOIC	D	8	75	Green (RoHS & no Sb/Br)	CU NIPDAU	Level-1-260C-UNLIM
TPS77625DR	ACTIVE	SOIC	D	8	2500	Green (RoHS & no Sb/Br)	CU NIPDAU	Level-1-260C-UNLIM
TPS77625DRG4	ACTIVE	SOIC	D	8	2500	Green (RoHS & no Sb/Br)	CU NIPDAU	Level-1-260C-UNLIM
TPS77625PWP	ACTIVE	HTSSOP	PWP	20	70	Green (RoHS & no Sb/Br)	CU NIPDAU	Level-2-260C-1 YEAR
TPS77625PWPG4	ACTIVE	HTSSOP	PWP	20	70	Green (RoHS & no Sb/Br)	CU NIPDAU	Level-2-260C-1 YEAR
TPS77625PWPR	ACTIVE	HTSSOP	PWP	20	2000	Green (RoHS & no Sb/Br)	CU NIPDAU	Level-2-260C-1 YEAR
TPS77625PWPRG4	ACTIVE	HTSSOP	PWP	20	2000	Green (RoHS & no Sb/Br)	CU NIPDAU	Level-2-260C-1 YEAR
TPS77628D	ACTIVE	SOIC	D	8	75	Green (RoHS & no Sb/Br)	CU NIPDAU	Level-1-260C-UNLIM
TPS77628DG4	ACTIVE	SOIC	D	8	75	Green (RoHS & no Sb/Br)	CU NIPDAU	Level-1-260C-UNLIM
TPS77628DR	ACTIVE	SOIC	D	8	2500	Green (RoHS & no Sb/Br)	CU NIPDAU	Level-1-260C-UNLIM
TPS77628DRG4	ACTIVE	SOIC	D	8	2500	Green (RoHS & no Sb/Br)	CU NIPDAU	Level-1-260C-UNLIM

Orderable Device	Status <sup>(1)</sup>	Package Type	Package Drawing	Pins	Package Qty	Eco Plan <sup>(2)</sup>	Lead/Ball Finish	MSL Peak Temp <sup>(3)</sup>
TPS77628PWP	ACTIVE	HTSSOP	PWP	20	70	Green (RoHS & no Sb/Br)	CU NIPDAU	Level-2-260C-1 YEAR
TPS77628PWPG4	ACTIVE	HTSSOP	PWP	20	70	Green (RoHS & no Sb/Br)	CU NIPDAU	Level-2-260C-1 YEAR
TPS77628PWPR	ACTIVE	HTSSOP	PWP	20	2000	Green (RoHS & no Sb/Br)	CU NIPDAU	Level-2-260C-1 YEAR
TPS77633D	ACTIVE	SOIC	D	8	75	Green (RoHS & no Sb/Br)	CU NIPDAU	Level-1-260C-UNLIM
TPS77633DR	ACTIVE	SOIC	D	8	2500	Green (RoHS & no Sb/Br)	CU NIPDAU	Level-1-260C-UNLIM
TPS77633DRG4	ACTIVE	SOIC	D	8	2500	Green (RoHS & no Sb/Br)	CU NIPDAU	Level-1-260C-UNLIM
TPS77633PWP	ACTIVE	HTSSOP	PWP	20	70	Green (RoHS & no Sb/Br)	CU NIPDAU	Level-2-260C-1 YEAR
TPS77633PWPR	ACTIVE	HTSSOP	PWP	20	2000	Green (RoHS & no Sb/Br)	CU NIPDAU	Level-2-260C-1 YEAR
TPS77633PWPRG4	ACTIVE	HTSSOP	PWP	20	2000	Green (RoHS & no Sb/Br)	CU NIPDAU	Level-2-260C-1 YEAR

<sup>(1)</sup> The marketing status values are defined as follows:

**ACTIVE:** Product device recommended for new designs.

**LIFEBUY:** TI has announced that the device will be discontinued, and a lifetime-buy period is in effect.

**NRND:** Not recommended for new designs. Device is in production to support existing customers, but TI does not recommend using this part in a new design.

**PREVIEW:** Device has been announced but is not in production. Samples may or may not be available.

**OBSELETE:** TI has discontinued the production of the device.

<sup>(2)</sup> Eco Plan - The planned eco-friendly classification: Pb-Free (RoHS) or Green (RoHS & no Sb/Br) - please check <http://www.ti.com/productcontent> for the latest availability information and additional product content details.

**TBD:** The Pb-Free/Green conversion plan has not been defined.

**Pb-Free (RoHS):** TI's terms "Lead-Free" or "Pb-Free" mean semiconductor products that are compatible with the current RoHS requirements for all 6 substances, including the requirement that lead not exceed 0.1% by weight in homogeneous materials. Where designed to be soldered at high temperatures, TI Pb-Free products are suitable for use in specified lead-free processes.

**Green (RoHS & no Sb/Br):** TI defines "Green" to mean Pb-Free (RoHS compatible), and free of Bromine (Br) and Antimony (Sb) based flame retardants (Br or Sb do not exceed 0.1% by weight in homogeneous material)

<sup>(3)</sup> MSL, Peak Temp. -- The Moisture Sensitivity Level rating according to the JEDEC industry standard classifications, and peak solder temperature.

**Important Information and Disclaimer:**The information provided on this page represents TI's knowledge and belief as of the date that it is provided. TI bases its knowledge and belief on information provided by third parties, and makes no representation or warranty as to the accuracy of such information. Efforts are underway to better integrate information from third parties. TI has taken and continues to take reasonable steps to provide representative and accurate information but may not have conducted destructive testing or chemical analysis on incoming materials and chemicals. TI and TI suppliers consider certain information to be proprietary, and thus CAS numbers and other limited information may not be available for release.

In no event shall TI's liability arising out of such information exceed the total purchase price of the TI part(s) at issue in this document sold by TI to Customer on an annual basis.

PWP (R-PDSO-G\*\*) 20 PIN SHOWN

PowerPAD™ PLASTIC SMALL-OUTLINE PACKAGE

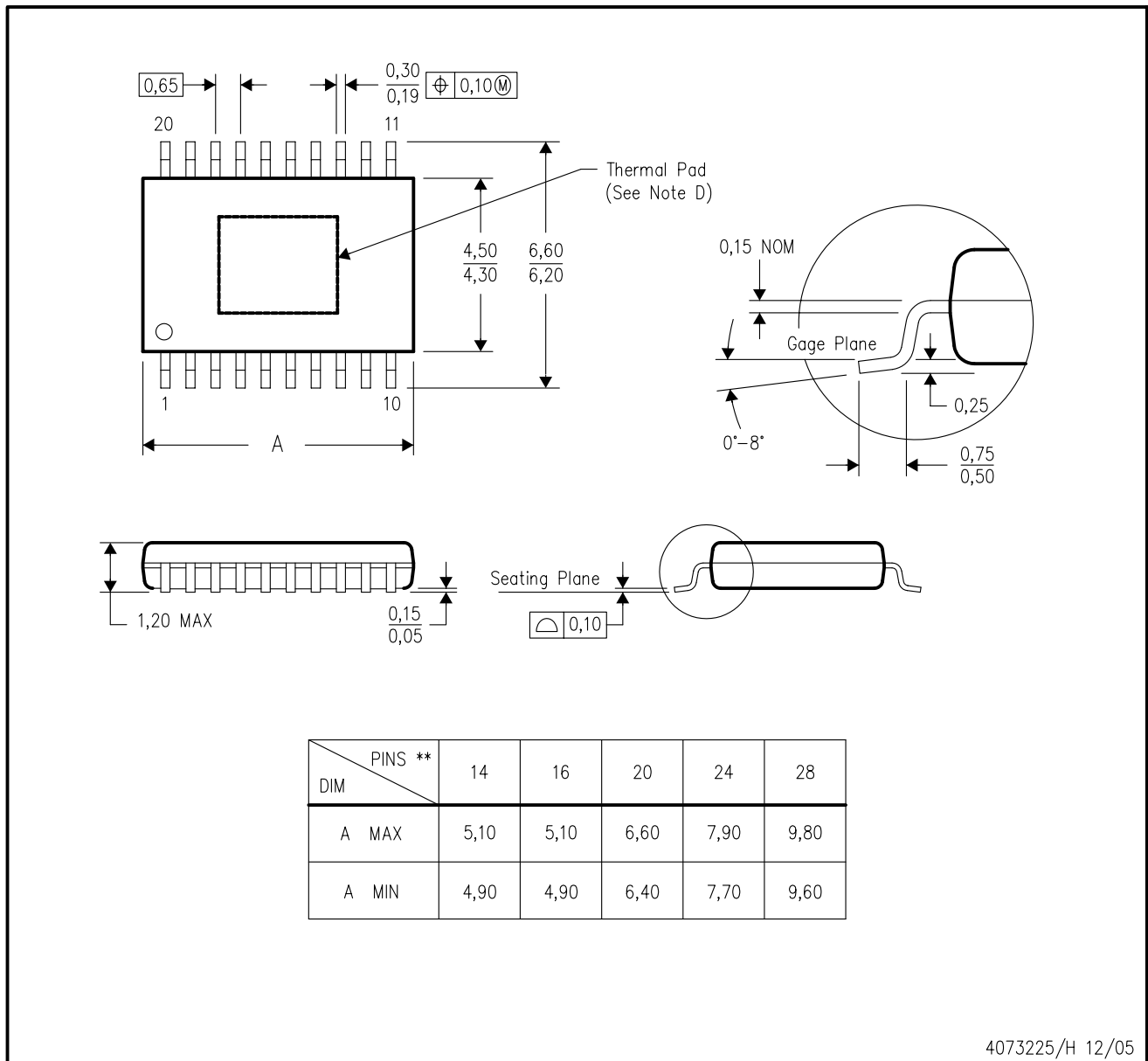

4073225/H 12/05

- NOTES:
- A. All linear dimensions are in millimeters.
  - B. This drawing is subject to change without notice.
  - C. Body dimensions do not include mold flash or protrusions. Mold flash and protrusion shall not exceed 0.15 per side.
  - D. This package is designed to be soldered to a thermal pad on the board. Refer to Technical Brief, PowerPad Thermally Enhanced Package, Texas Instruments Literature No. SLMA002 for information regarding recommended board layout. This document is available at [www.ti.com](http://www.ti.com) <<http://www.ti.com>>.
  - E. Falls within JEDEC MO-153

PowerPAD is a trademark of Texas Instruments.





## IMPORTANT NOTICE

Texas Instruments Incorporated and its subsidiaries (TI) reserve the right to make corrections, modifications, enhancements, improvements, and other changes to its products and services at any time and to discontinue any product or service without notice. Customers should obtain the latest relevant information before placing orders and should verify that such information is current and complete. All products are sold subject to TI's terms and conditions of sale supplied at the time of order acknowledgment.

TI warrants performance of its hardware products to the specifications applicable at the time of sale in accordance with TI's standard warranty. Testing and other quality control techniques are used to the extent TI deems necessary to support this warranty. Except where mandated by government requirements, testing of all parameters of each product is not necessarily performed.

TI assumes no liability for applications assistance or customer product design. Customers are responsible for their products and applications using TI components. To minimize the risks associated with customer products and applications, customers should provide adequate design and operating safeguards.

TI does not warrant or represent that any license, either express or implied, is granted under any TI patent right, copyright, mask work right, or other TI intellectual property right relating to any combination, machine, or process in which TI products or services are used. Information published by TI regarding third-party products or services does not constitute a license from TI to use such products or services or a warranty or endorsement thereof. Use of such information may require a license from a third party under the patents or other intellectual property of the third party, or a license from TI under the patents or other intellectual property of TI.

Reproduction of information in TI data books or data sheets is permissible only if reproduction is without alteration and is accompanied by all associated warranties, conditions, limitations, and notices. Reproduction of this information with alteration is an unfair and deceptive business practice. TI is not responsible or liable for such altered documentation.

Resale of TI products or services with statements different from or beyond the parameters stated by TI for that product or service voids all express and any implied warranties for the associated TI product or service and is an unfair and deceptive business practice. TI is not responsible or liable for any such statements.

Following are URLs where you can obtain information on other Texas Instruments products and application solutions:

<b>Products</b>		<b>Applications</b>	
Amplifiers	<a href="http://amplifier.ti.com">amplifier.ti.com</a>	Audio	<a href="http://www.ti.com/audio">www.ti.com/audio</a>
Data Converters	<a href="http://dataconverter.ti.com">dataconverter.ti.com</a>	Automotive	<a href="http://www.ti.com/automotive">www.ti.com/automotive</a>
DSP	<a href="http://dsp.ti.com">dsp.ti.com</a>	Broadband	<a href="http://www.ti.com/broadband">www.ti.com/broadband</a>
Interface	<a href="http://interface.ti.com">interface.ti.com</a>	Digital Control	<a href="http://www.ti.com/digitalcontrol">www.ti.com/digitalcontrol</a>
Logic	<a href="http://logic.ti.com">logic.ti.com</a>	Military	<a href="http://www.ti.com/military">www.ti.com/military</a>
Power Mgmt	<a href="http://power.ti.com">power.ti.com</a>	Optical Networking	<a href="http://www.ti.com/opticalnetwork">www.ti.com/opticalnetwork</a>
Microcontrollers	<a href="http://microcontroller.ti.com">microcontroller.ti.com</a>	Security	<a href="http://www.ti.com/security">www.ti.com/security</a>
		Telephony	<a href="http://www.ti.com/telephony">www.ti.com/telephony</a>
		Video & Imaging	<a href="http://www.ti.com/video">www.ti.com/video</a>
		Wireless	<a href="http://www.ti.com/wireless">www.ti.com/wireless</a>

Mailing Address: Texas Instruments  
Post Office Box 655303 Dallas, Texas 75265