

1N5221B THRU 1N5267B

List

List..... 1

Package outline..... 2

Features..... 2

Mechanical data..... 2

Maximum ratings 2

Electrical characteristics..... 3

Rating and characteristic curves..... 4~5

Pinning information..... 6

Taping & bulk specifications for AXIAL devices..... 6

Suggested thermal profiles for soldering processes..... 7

High reliability test capabilities..... 8

1N5221B THRU 1N5267B

500mW Axial Lead Zener Diodes - 2.4V-75V

Features

- Silicon epitaxial planar chip structure.
- Leaded glass hermetically sealed package.
- Wide zener reverse voltage range 2.4V to 75V.
- Standard zener voltage tolerance $\pm 5\%$ with a "B" suffix.
- Other tolerance are available upon request.
- Lead-free parts meet environmental standards of MIL-STD-19500 /228

Mechanical data

- Case : Glass, DO-35G
- Terminals :Plated terminals, solderable per MIL-STD-750, Method 2026
- Polarity : Indicated by cathode band
- Mounting Position : Any
- Weight : Approximated 0.125 gram

Package outline

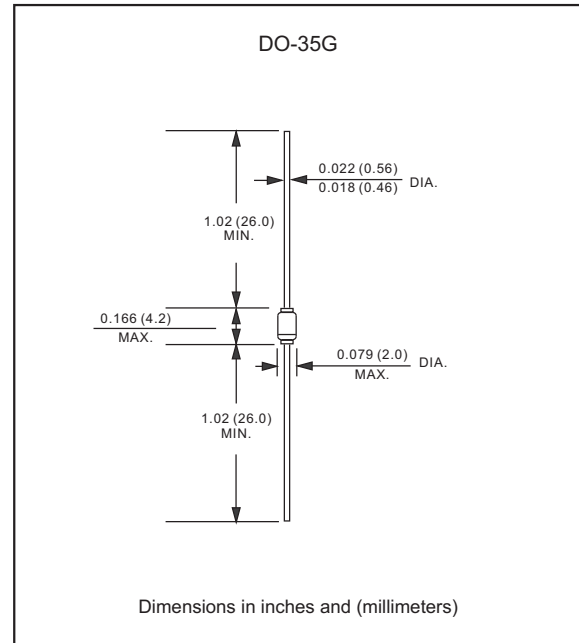

Maximum ratings (at $T_A=25^\circ\text{C}$ unless otherwise noted)

PARAMETER	CONDITIONS	Symbol	MIN.	TYP.	MAX.	UNIT
Forward voltage	$I_F = 100 \text{ mA}$	V_F			1.10	V
Power Dissipation	$T_{amb} \leq 75^\circ\text{C}$	P_D			500	mW
Operating temperature		T_J	-55		+150	$^\circ\text{C}$
Storage temperature		T_{STG}	-65		+175	$^\circ\text{C}$

Electrical characteristics (at T_A=25°C unless otherwise noted)

Part No.	Marking code	Zener voltage			Test current	Zener impedance			Leakage current	
		V _Z @ I _{ZT} (Volts)			I _{ZT}	Z _{ZT} @ I _{ZT}	Z _{ZK} @ I _{ZK}	I _{ZK}	I _R	V _R
		Min.	Nom.	Max.	mA	Max. (Ω)	Max. (Ω)	mA	Max. (μA)	Volts
1N5221B	1N5221B	2.28	2.4	2.52	20.0	30	1200	0.25	100	1.0
1N5222B	1N5222B	2.38	2.5	2.63	20.0	30	1250	0.25	100	1.0
1N5223B	1N5223B	2.57	2.7	2.84	20.0	30	1300	0.25	75	1.0
1N5224B	1N5224B	2.66	2.8	2.94	20.0	30	1400	0.25	75	1.0
1N5225B	1N5225B	2.85	3.0	3.15	20.0	29	1600	0.25	50	1.0
1N5226B	1N5226B	3.14	3.3	3.47	20.0	28	1600	0.25	25	1.0
1N5227B	1N5227B	3.42	3.6	3.78	20.0	24	1700	0.25	15	1.0
1N5228B	1N5228B	3.71	3.9	4.10	20.0	23	1900	0.25	10	1.0
1N5229B	1N5229B	4.09	4.3	4.52	20.0	22	2000	0.25	5.0	1.0
1N5230B	1N5230B	4.47	4.7	4.94	20.0	19	1900	0.25	5.0	2.0
1N5231B	1N5231B	4.85	5.1	5.36	20.0	17	1600	0.25	5.0	2.0
1N5232B	1N5232B	5.32	5.6	5.88	20.0	11	1600	0.25	5.0	3.0
1N5233B	1N5233B	5.70	6.0	6.30	20.0	7	1600	0.25	5.0	3.5
1N5234B	1N5234B	5.89	6.2	6.51	20.0	7	1000	0.25	5.0	4.0
1N5235B	1N5235B	6.46	6.8	7.14	20.0	5	750	0.25	3.0	5.0
1N5236B	1N5236B	7.13	7.5	7.88	20.0	6	500	0.25	3.0	6.0
1N5237B	1N5237B	7.79	8.2	8.61	20.0	8	500	0.25	3.0	6.5
1N5238B	1N5238B	8.27	8.7	9.14	20.0	8	600	0.25	3.0	6.5
1N5239B	1N5239B	8.65	9.1	9.56	20.0	10	600	0.25	3.0	7.0
1N5240B	1N5240B	9.50	10	10.50	20.0	17	600	0.25	3.0	8.0
1N5241B	1N5241B	10.45	11	11.55	20.0	22	600	0.25	2.0	8.4
1N5242B	1N5242B	11.40	12	12.60	20.0	30	600	0.25	1.0	9.1
1N5243B	1N5243B	12.35	13	13.65	9.5	13	600	0.25	0.5	9.9
1N5244B	1N5244B	13.30	14	14.70	9.0	15	600	0.25	0.1	10
1N5245B	1N5245B	14.25	15	15.75	8.5	16	600	0.25	0.1	11
1N5246B	1N5246B	15.20	16	16.80	7.8	17	600	0.25	0.1	12
1N5247B	1N5247B	16.15	17	17.85	7.4	19	600	0.25	0.1	13
1N5248B	1N5248B	17.10	18	18.90	7.0	21	600	0.25	0.1	14
1N5249B	1N5249B	18.05	19	19.95	6.6	23	600	0.25	0.1	14
1N5250B	1N5250B	19.00	20	21.00	6.2	25	600	0.25	0.1	15
1N5251B	1N5251B	20.90	22	23.10	5.6	29	600	0.25	0.1	17
1N5252B	1N5252B	22.80	24	25.20	5.2	33	600	0.25	0.1	18
1N5253B	1N5253B	23.75	25	26.25	5.0	35	600	0.25	0.1	19
1N5254B	1N5254B	25.65	27	28.35	4.6	41	600	0.25	0.1	21
1N5255B	1N5255B	26.60	28	29.40	4.5	44	600	0.25	0.1	21
1N5256B	1N5256B	28.50	30	31.50	4.2	49	600	0.25	0.1	23
1N5257B	1N5257B	31.35	33	34.65	3.8	58	700	0.25	0.1	25
1N5258B	1N5258B	34.20	36	37.80	3.4	70	700	0.25	0.1	27
1N5259B	1N5259B	37.05	39	40.95	3.2	80	800	0.25	0.1	30
1N5260B	1N5260B	40.85	43	45.15	3.0	93	900	0.25	0.1	33
1N5261B	1N5261B	44.65	47	49.35	2.7	105	1000	0.25	0.1	36
1N5262B	1N5262B	48.45	51	53.55	2.5	125	1100	0.25	0.1	39
1N5263B	1N5263B	53.20	56	58.80	2.2	150	1300	0.25	0.1	43
1N5264B	1N5264B	57.00	60	63.00	2.1	170	1400	0.25	0.1	46
1N5265B	1N5265B	58.90	62	65.10	2.0	185	1400	0.25	0.1	47
1N5266B	1N5266B	64.60	68	71.40	1.8	230	1600	0.25	0.1	52
1N5267B	1N5267B	71.25	75	78.75	1.7	270	1700	0.25	0.1	56

Note : 5% tolerance of Zener voltage



Rating and characteristic curves (1N5221B THRU 1N5267B)

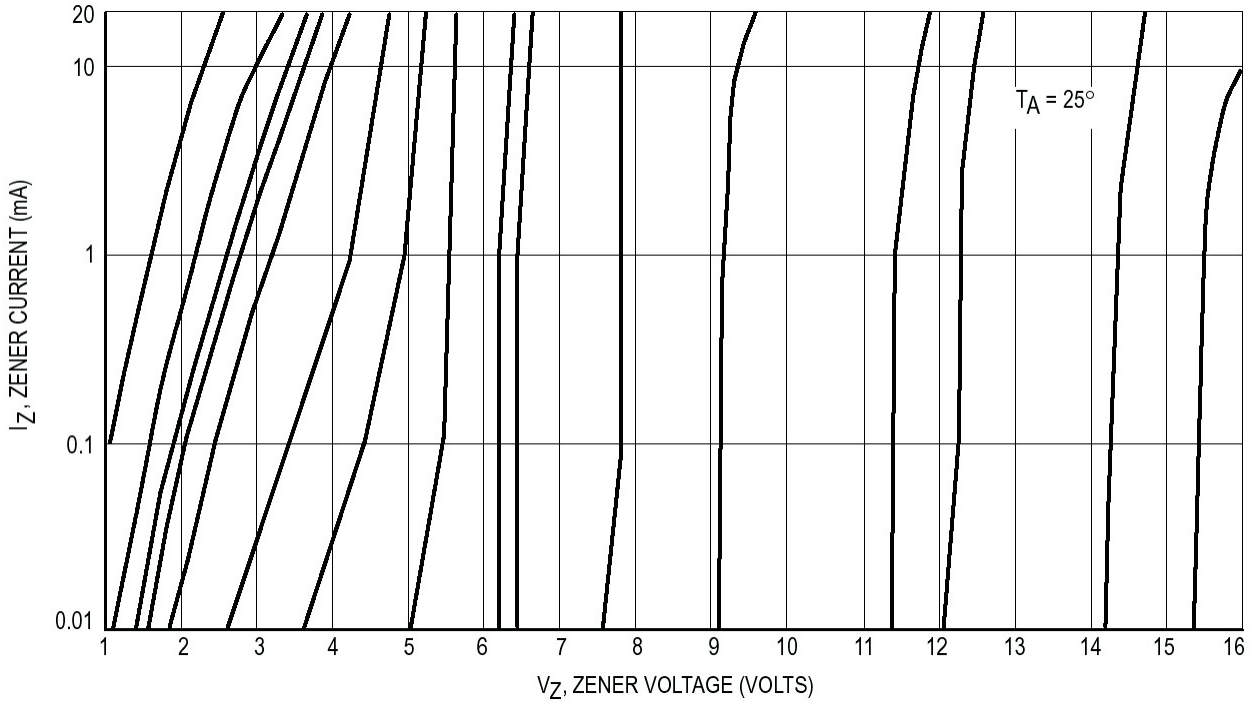

Figure 1. Zener Voltage versus Zener Current – $V_Z=1$ thru 16 Volts

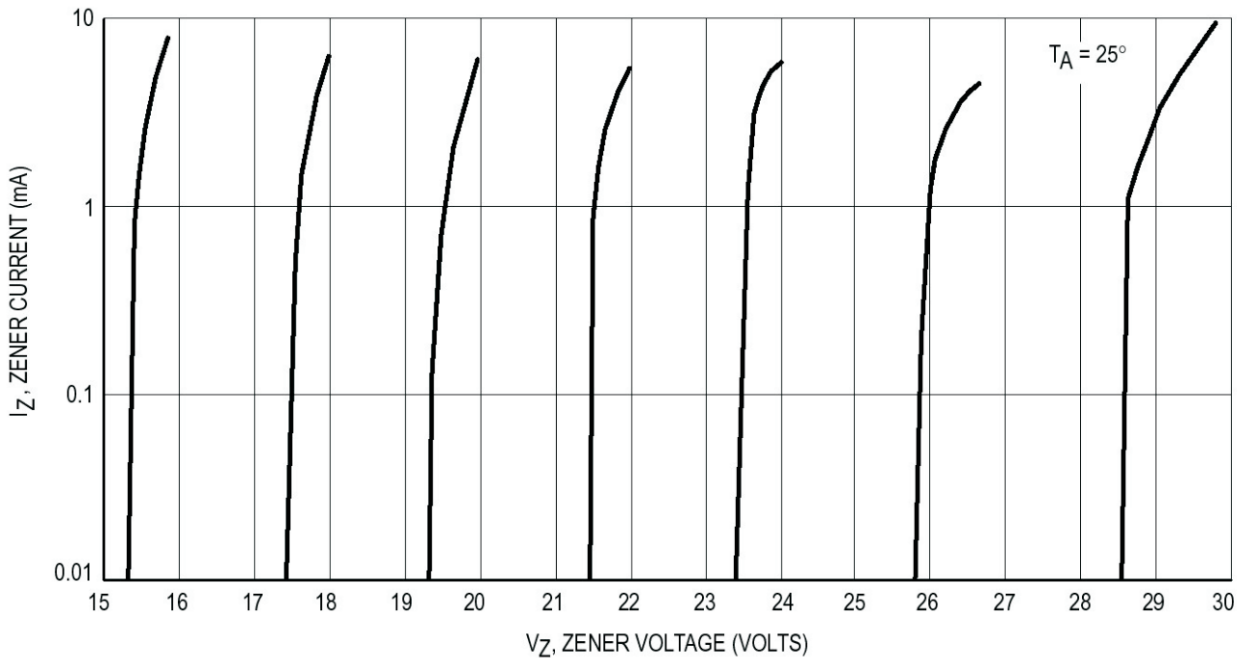

Figure 2. Zener Voltage versus Zener Current – $V_Z=15$ thru 30 Volts

Rating and characteristic curves (1N5221B THRU 1N5267B)

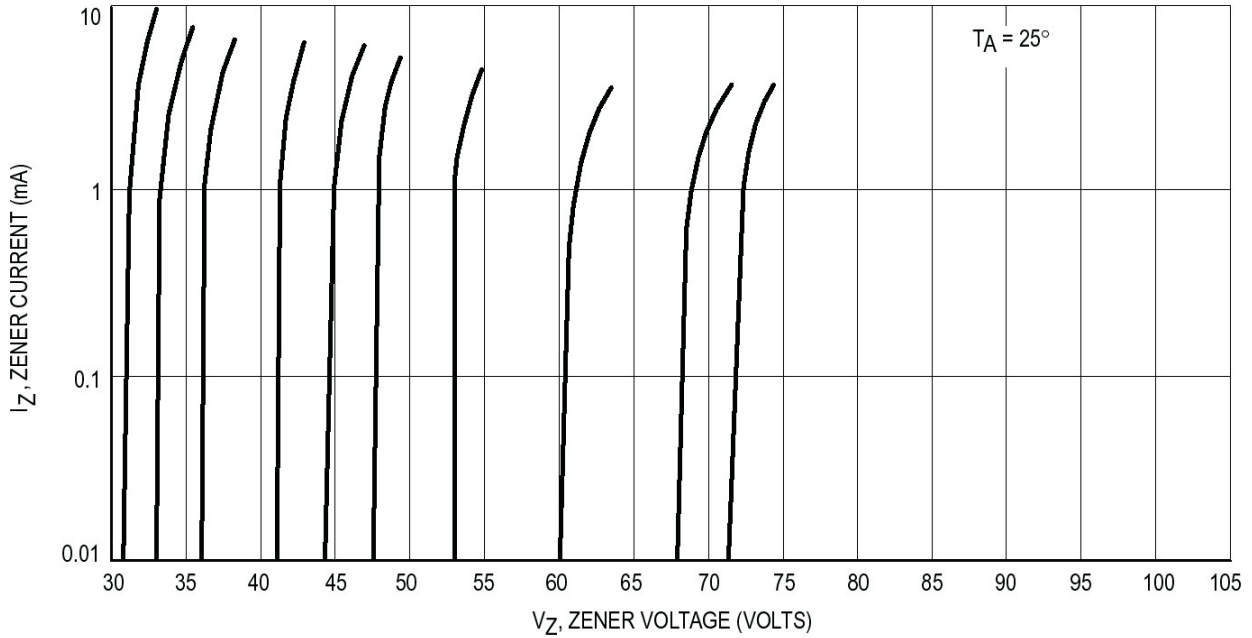

Figure 3. Zener Voltage versus Zener Current – Vz=30 thru 75 Volts

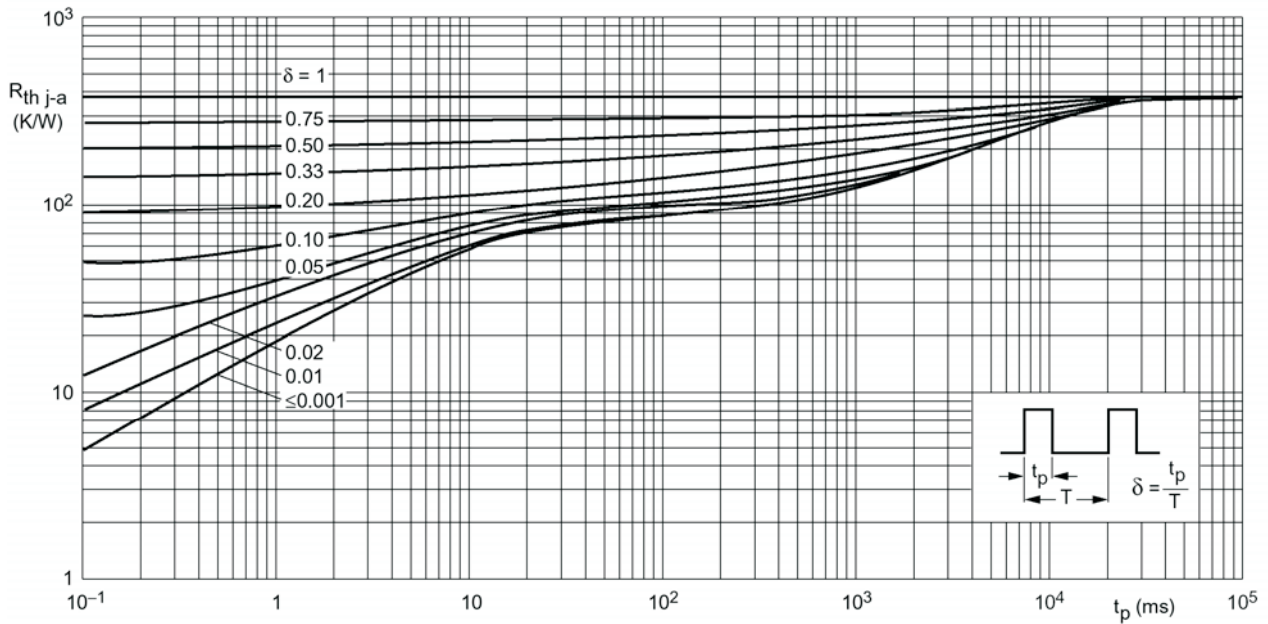



Figure 4. Thermal resistance from junction to ambient as a function of pulse duration

1N5221B THRU 1N5267B

Pinning information

Pin	Simplified outline	Symbol
Pin1 cathode Pin2 anode		

Taping & bulk specifications for AXIAL devices

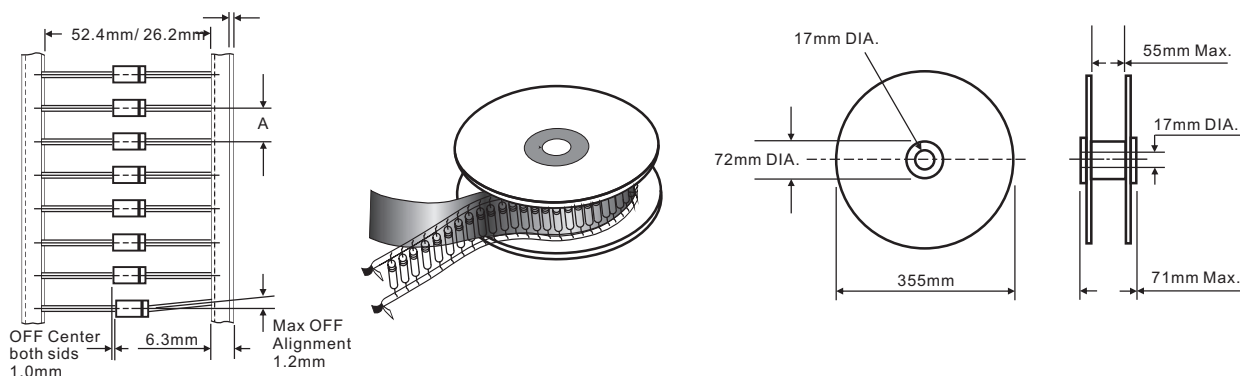

REEL PACKING

DEVICE CASE TYPE	Q'TY 1 (PCS / REEL)	COMPONENT SPACING "A" in FIG. A	CARTON SIZE (m/m)	Q'TY 2 (PCS / CARTON)	APPROX. CROSS WEIGHT(kg)
DO-35G/52mm	5,000	5 mm	360 * 340 * 370	20,000	7.3

AMMO PACKING

DEVICE CASE TYPE	Q'TY 1 (PCS / BOX)	INNER BOX SIZE (m/m)	CARTON SIZE (m/m)	Q'TY 2 (PCS / CARTON)	APPROX. CROSS WEIGHT(kg)
DO-35G/26mm	5,000	250 * 78 * 48	420 * 270 * 330	150,000	16.7
DO-35G/52mm	5,000	250 * 78 * 78	420 * 270 * 330	100,000	15.0

1N5221B THRU 1N5267B

BULK PACKING

DEVICE CASE TYPE	Q'TY 1 (PCS / BOX)	INNER BOX SIZE (m/m)	CARTON SIZE (m/m)	Q'TY 2 (PCS / CARTON)	APPROX. CROSS WEIGHT(kg)
DO-35G	2,000	96 * 80 * 42	410 * 335 * 265	120,000	17.4

Suggested thermal profiles for soldering processes

1. Lead free temperature profile wave-soldering

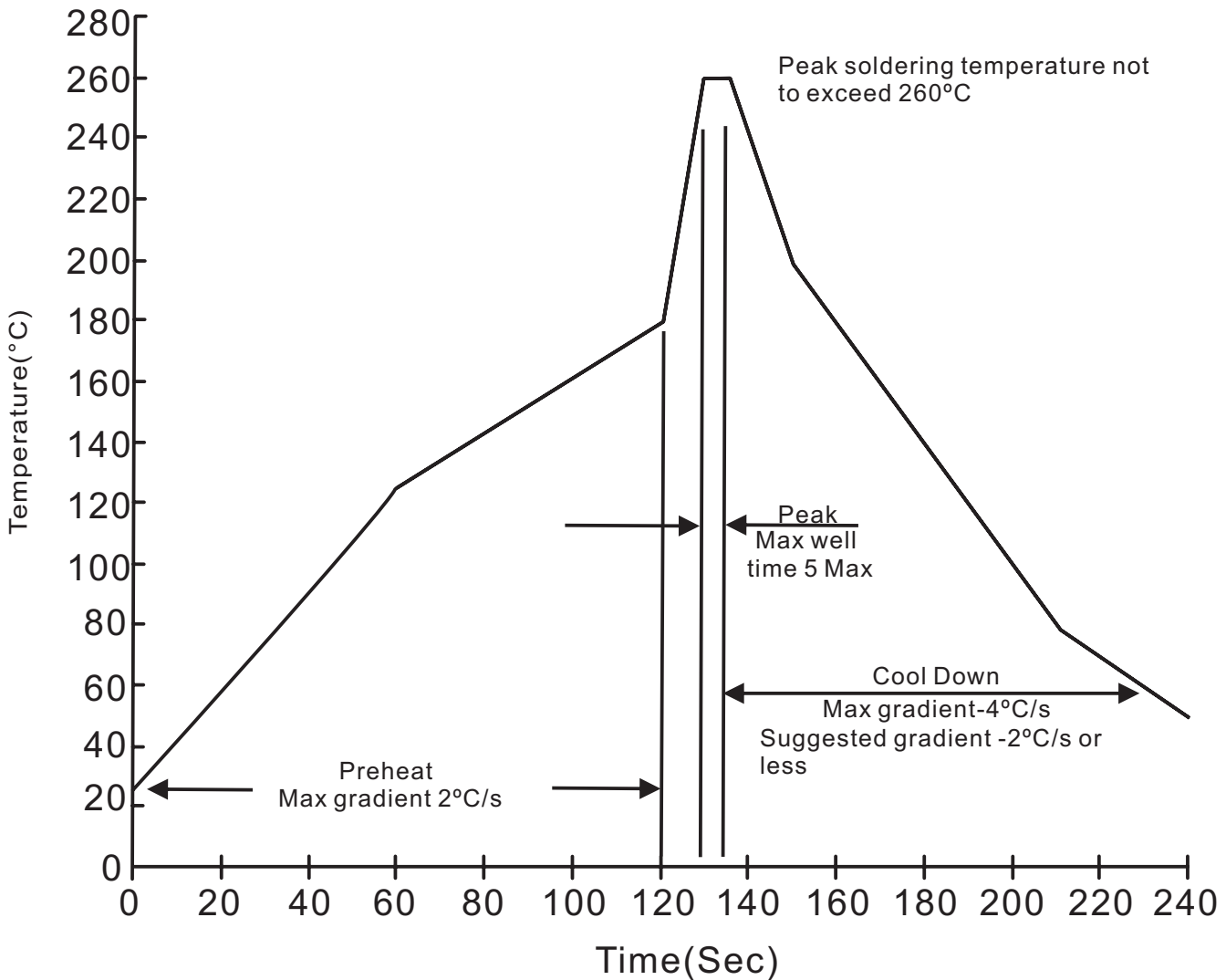

1N5221B THRU 1N5267B**High reliability test capabilities**

Item Test	Conditions	Reference
1. Solder Resistance	at 260±5°C for 10±2sec. immerse body into solder 1/16"±1/32"	MIL-STD-750D METHOD-2031
2. Solderability	at 245±5°C for 5 sec.	MIL-STD-202F METHOD-208
3. Pull Test	0.25kg in axial lead direction for 10 sec.	MIL-STD-750D METHOD-2036
4. Bend Lead	0.25kg weight applied to each lead bending arc 90°±5° for 3 times.	MIL-STD-750D METHOD-2036
5. High Temperature Reverse Bias	V _R =80% rate at T _J =150°C for 168 hrs.	MIL-STD-750D METHOD-1038
6. Pressure Cooker	15P _{SIG} at T _A =121°C for 4 hrs.	JESD22-A102
7. Temperature Cycling	-55°C to +125°C dwelled for 30 min. and transferred for 5min. total 10 cycles.	MIL-STD-750D METHOD-1051
8. Thermal Shock	0°C for 5 min. rise to 100°C for 5 min. total 10 cycles.	MIL-STD-750D METHOD-1056
9. Humidity	at T _A =85°C, RH=85% for 1000hrs.	MIL-STD-750D METHOD-1021
10. High Temperature Storage Life	at 175°C for 1000 hrs.	MIL-STD-750D METHOD-1031