**LOW NOISE 150mA LDO
REGULATOR
R1112N SERIES**

APPLICATION MANUAL

Datasheet.Live

R1112N SERIES

OUTLINE

The R1112N Series are voltage regulator ICs with high output voltage accuracy, extremely low supply current, low ON-resistance, and high ripple rejection by CMOS process. Each of these voltage regulator ICs consists of a voltage reference unit, an error amplifier, resistors, a current limit circuit, and a chip enable circuit.

These ICs perform with low dropout voltage and a chip enable function. The line transient response and load transient response of the R1112N Series are excellent, thus these ICs are very suitable for the power supply for hand-held communication equipment.

The output voltage of these ICs is fixed with high accuracy. Since the package for these ICs are SOT-23-5 (Mini-mold) package, high density mounting of the ICs on boards is possible.

FEATURES

- Ultra-Low Supply Current TYP. 100 μ A
- Standby Mode Current..... TYP. 0.1 μ A
- Low Dropout Voltage TYP. 0.19V ($I_{OUT}=100\text{mA}$ 3.0V Output type)
- High Ripple Rejection TYP. 80dB($f=1\text{kHz}$)
- Low Temperature-Drift Coefficient of Output Voltage TYP. $\pm 100\text{ppm}/^{\circ}\text{C}$
- Excellent Line Regulation..... TYP. 0.05%/V
- High Output Voltage Accuracy $\pm 2.0\%$
- Excellent Dynamic Response
- Small Package SOT-23-5 (Mini-mold)
- Output Voltage..... Stepwise setting with a step of 0.1V in the range of 1.5V to 5.0V is possible
- Built-in chip enable circuit (2 types; A: active low, B: active high)
- Pin-out..... Similar to the LP2980/LP2985
- Built-in fold-back protection circuit..... TYP. 30mA (Current at short mode)
- Ceramic capacitors recommended to be used with this IC

APPLICATIONS

- Power source for cellular phones such as GSM, CDMA and various kind of PCSs.
- Power source for electrical appliances such as cameras, VCRs and camcorders.
- Power source for battery-powered equipment.

BLOCK DIAGRAM

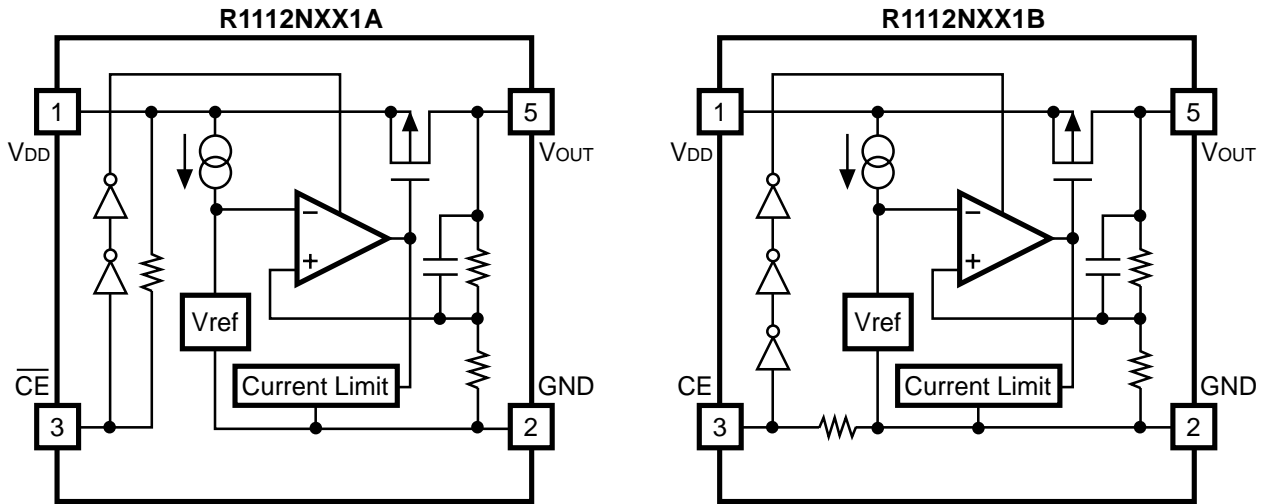

SELECTION GUIDE

The output voltage, the active type, the packing type, and the taping type for the ICs can be selected at the user's request. The selection can be made by designating the part number as shown below:

R1112XXX1X-XX ←Part Number
 ↑ ↑ ↑ ↑
 a b c d

Code	Contents
a	Designation of Package Type: N: SOT-23-5 (Mini-mold)
b	Setting Output Voltage (V_{OUT}): Stepwise setting with a step of 0.1V in the range of 1.5V to 5.0V is possible.
c	Designation of Active Type: A: active low type B: active high type
d	Designation of Taping Type: Ex. TR, TL (refer to Taping Specifications; TR type is the standard direction.)

PIN CONFIGURATION

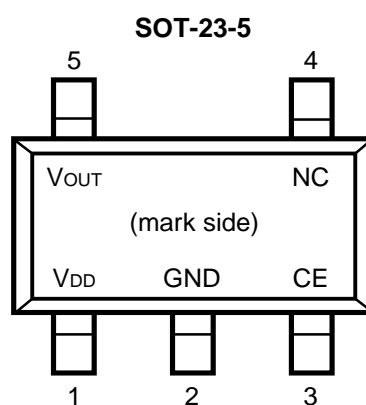

PIN DESCRIPTION

Pin No.	Symbol	Description
1	V _{DD}	Input Pin
2	GND	Ground Pin
3	$\overline{\text{CE}}$ or CE	Chip Enable Pin
4	NC	No Connection
5	V _{OUT}	Output pin

ABSOLUTE MAXIMUM RATINGS

Symbol	Item	Rating	Unit
V_{IN}	Input Voltage	7.0	V
V_{CE}	Input Voltage(\overline{CE} or CE Pin)	-0.3 ~ $V_{IN}+0.3$	V
V_{OUT}	Output Voltage	-0.3 ~ $V_{IN}+0.3$	V
I_{OUT}	Output Current	200	mA
P_D	Power Dissipation	250	mW
T_{opt}	Operating Temperature Range	-40 ~ 85	°C
T_{stg}	Storage Temperature Range	-55 ~ 125	°C

ELECTRICAL CHARACTERISTICS

• R1112NXX1A

 $T_{opt}=25^{\circ}\text{C}$

Symbol	Item	Conditions	MIN.	TYP.	MAX.	Unit
V_{OUT}	Output Voltage	$V_{IN} = \text{Set } V_{OUT}+1\text{V}$ $1\text{mA} \leq I_{OUT} \leq 30\text{mA}$	V_{OUT} $\times 0.98$		V_{OUT} $\times 1.02$	V
I_{OUT}	Output Current	$V_{IN} - V_{OUT} = 1.0\text{V}$	150			mA
$\Delta V_{OUT}/\Delta I_{OUT}$	Load Regulation	$V_{IN} = \text{Set } V_{OUT}+1\text{V}$ $1\text{mA} \leq I_{OUT} \leq 80\text{mA}$		12	40	mV
V_{DIF}	Dropout Voltage	Refer to the ELECTRICAL CHARACTERISTICS by OUTPUT VOLTAGE				
I_{SS}	Supply Current	$V_{IN} = \text{Set } V_{OUT}+1\text{V}$		100	170	μA
Istandby	Supply Current (Standby)	$V_{IN} = V_{CE} = \text{Set } V_{OUT}+1\text{V}$		0.1	1.0	μA
$\Delta V_{OUT}/\Delta V_{IN}$	Line Regulation	Set $V_{OUT}+0.5\text{V} \leq V_{IN} \leq 8\text{V}$ $I_{OUT} = 30\text{mA}$		0.05	0.20	%/V
RR	Ripple Rejection	$f = 1\text{kHz}$, Ripple 0.5Vp-p $V_{IN} = \text{Set } V_{OUT}+1\text{V}$		80		dB
V_{IN}	Input Voltage		2.0		6.0	V
$\Delta V_{OUT}/\Delta T$	Output Voltage Temperature Coefficient	$I_{OUT} = 30\text{mA}$ $-40^{\circ}\text{C} \leq T_{opt} \leq 85^{\circ}\text{C}$		± 100		ppm/ °C
I_{lim}	Short Current Limit	$V_{OUT} = 0\text{V}$		30		mA
R_{PU}	\overline{CE} Pull-up Resistance		2.5	5	10	$\text{M}\Omega$
V_{CEH}	\overline{CE} Input Voltage "H"		1.5		V_{IN}	V
V_{CEL}	\overline{CE} Input Voltage "L"		0		0.25	V
e_n	Output Noise	BW=10Hz to 100kHz		30		μVrms

• R1112NXX1B

Topt=25°C

Symbol	Item	Conditions	MIN.	TYP.	MAX.	Unit
V _{OUT}	Output Voltage	V _{IN} = Set V _{OUT} +1V 1mA ≤ I _{OUT} ≤ 30mA	V _{OUT} ×0.98		V _{OUT} ×1.02	V
I _{OUT}	Output Current	V _{IN} - V _{OUT} = 1.0V	150			mA
ΔV _{OUT} /ΔI _{OUT}	Load Regulation	V _{IN} = Set V _{OUT} +1V 1mA ≤ I _{OUT} ≤ 80mA		12	40	mV
V _{DIF}	Dropout Voltage	Refer to the ELECTRICAL CHARACTERISTICS by OUTPUT VOLTAGE				
I _{SS}	Supply Current	V _{IN} = Set V _{OUT} +1V		100	170	μA
I _{standby}	Supply Current (Standby)	V _{IN} = Set V _{OUT} +1V V _{CE} =GND		0.1	1.0	μA
ΔV _{OUT} /ΔV _{IN}	Line Regulation	Set V _{OUT} +0.5V ≤ V _{IN} ≤ 8V I _{OUT} = 30mA		0.05	0.20	%/V
RR	Ripple Rejection	f = 1kHz, Ripple 0.5Vp-p V _{IN} = Set V _{OUT} +1V		80		dB
V _{IN}	Input Voltage		2.0		6.0	V
ΔV _{OUT} /ΔT	Output Voltage Temperature Coefficient	I _{OUT} = 30mA -40°C ≤ Top t ≤ 85°C		±100		ppm /°C
I _{lim}	Short Current Limit	V _{OUT} = 0V		30		mA
R _{PD}	CE Pull-down Resistance		2.5	5	10	MΩ
V _{CEH}	CE Input Voltage "H"		1.5		V _{IN}	V
V _{CEL}	CE Input Voltage "L"		0		0.25	V
e _n	Output Noise	BW=10Hz to 100kHz		30		μVrms

• ELECTRICAL CHARACTERISTICS by OUTPUT VOLTAGE

Topt = 25°C

Output Voltage V _{OUT} (V)	Dropout Voltage		
	V _{DIF} (V)		
	Condition	TYP.	MAX.
1.5 ≤ V _{OUT} ≤ 1.6	I _{OUT} = 100mA	0.32	0.55
1.7 ≤ V _{OUT} ≤ 1.8		0.28	0.47
1.9 ≤ V _{OUT} ≤ 2.3		0.25	0.35
2.4 ≤ V _{OUT} ≤ 2.7		0.20	0.29
2.8 ≤ V _{OUT} ≤ 5.0		0.19	0.26

OPERATION

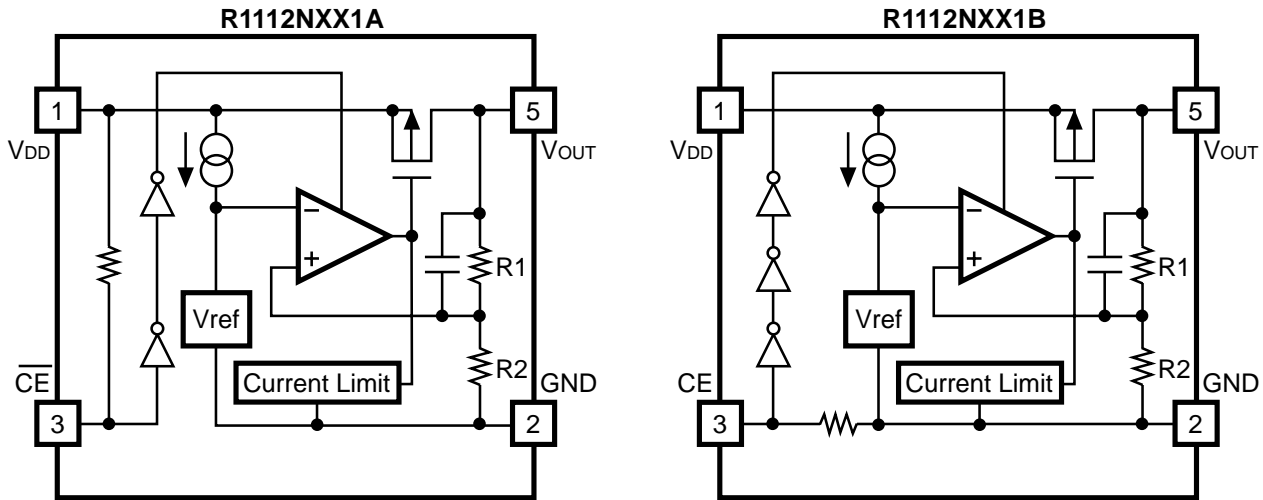

In these ICs, fluctuation of Output Voltage, V_{OUT} is detected by Feed-back Registers R1, R2, and the result is compared with a reference voltage by Error Amplifier, so that a constant voltage is output. A current limit circuit for protection at short mode and a chip enable circuit are included.

TECHNICAL NOTES

When using these ICs, consider the following points:

Phase Compensation

In these ICs, phase compensation is made for securing stable operation even if the load current is varied. For this purpose, be sure to use a capacitor C_{OUT} with good frequency characteristics and ESR (Equivalent Series Resistance). We use Ceramic Capacitors for evaluation of these ICs.

Recommended Capacitors; GRM40X5R225K6.3 (Murata)

GRM40-034X5R335K6.3 (Murata)

GRM40-034X5R475K6.3 (Murata)

(Note: When the additional ceramic capacitors are connected to the Output Pin with Output capacitor for phase compensation, the operation might be unstable. Because of this, test these ICs with as same external components as ones to be used on the PCB.)

PCB Layout

Make V_{DD} and GND line sufficient. When the impedance of these is high, it would be a cause of picking up the noise or unstable operation. Connect a capacitor with a capacitance value of $2.2\mu\text{F}$ or more between V_{DD} and GND pin as close as possible.

Set external components, especially output capacitor as close as possible to the ICs and make wiring shortest.

TEST CIRCUITS

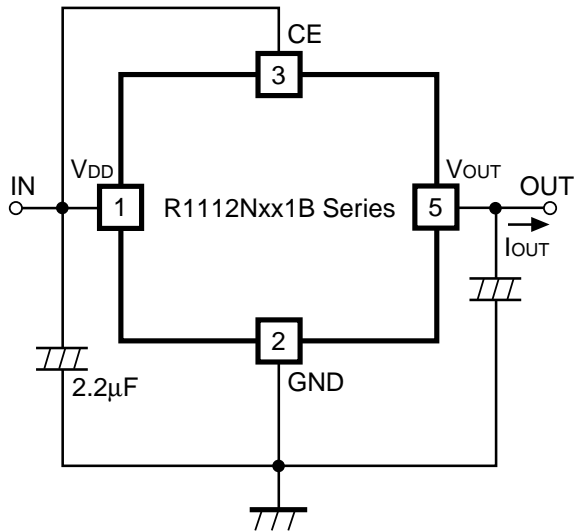

Fig.1 Standard test Circuit

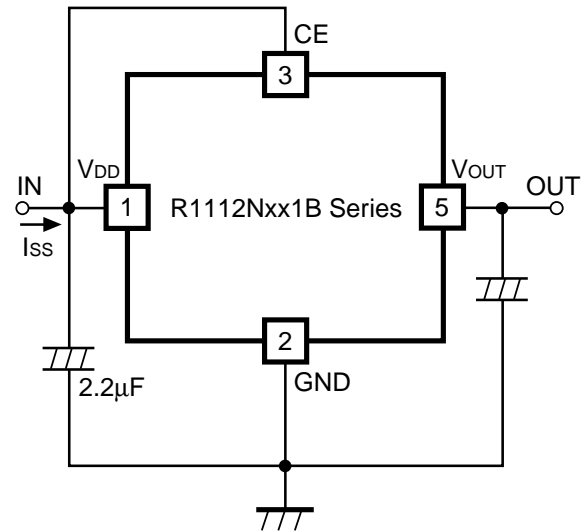

Fig.2 Supply Current Test Circuit

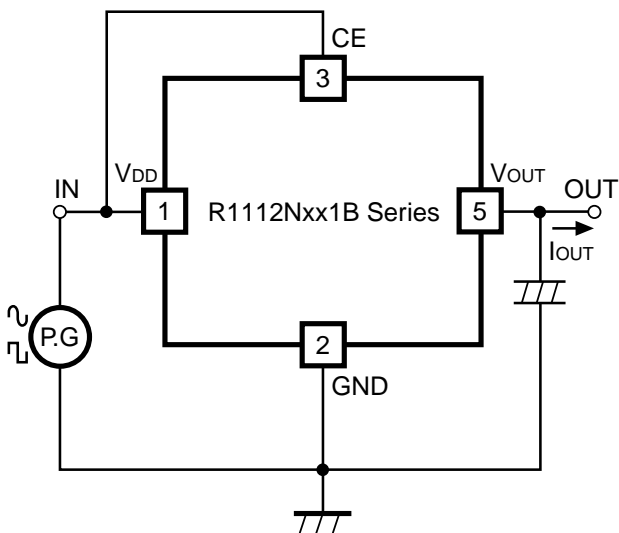

Fig.3 Ripple Rejection, Line Transient Response Test Circuit

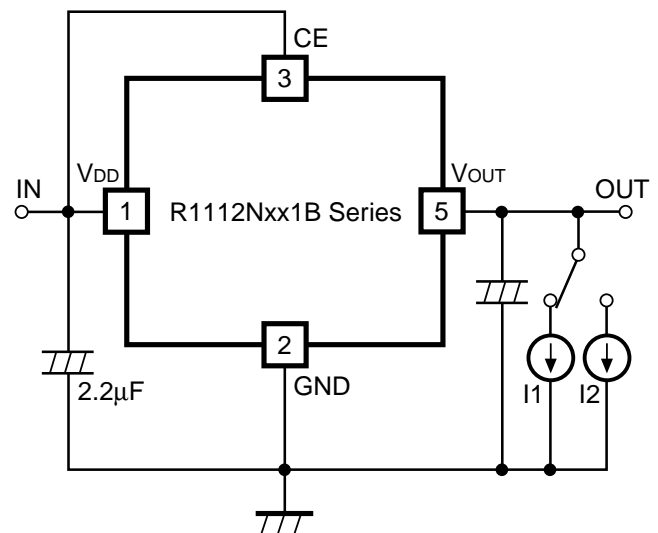
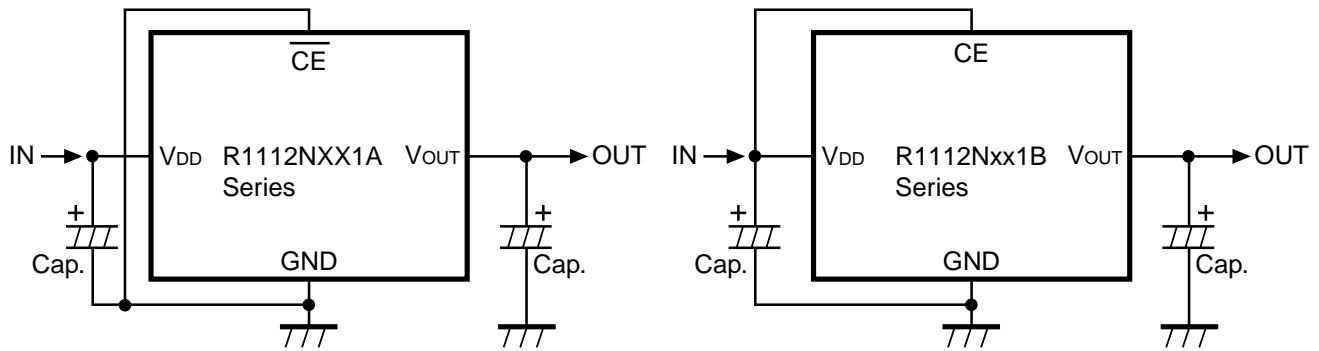

Fig.4 Load Transient Response Test Circuit

TYPICAL APPLICATION

(External Components)

Output Capacitor; Ceramic 2.2 μ F (Set Output Voltage in the range from 2.5 to 5.0V)

Ceramic 4.7 μ F (Set Output Voltage in the range from 1.5 to 2.5V)

Input Capacitor; Ceramic 2.2 μ F

TYPICAL CHARACTERISTICS

1) Output Voltage vs. Output Current

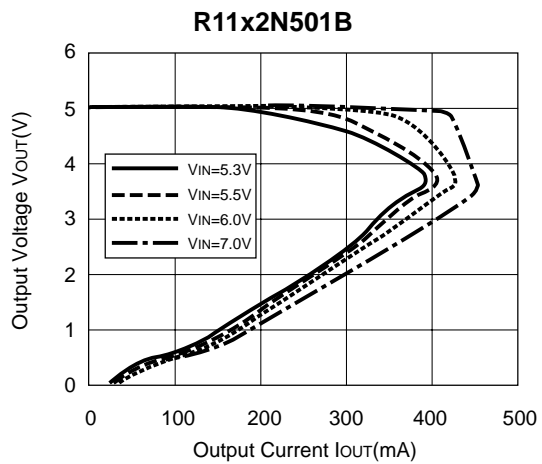
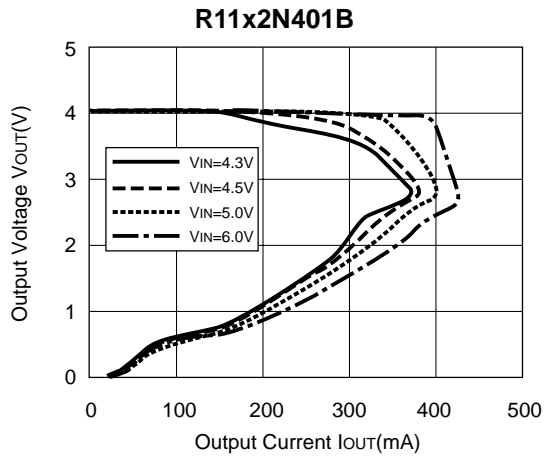
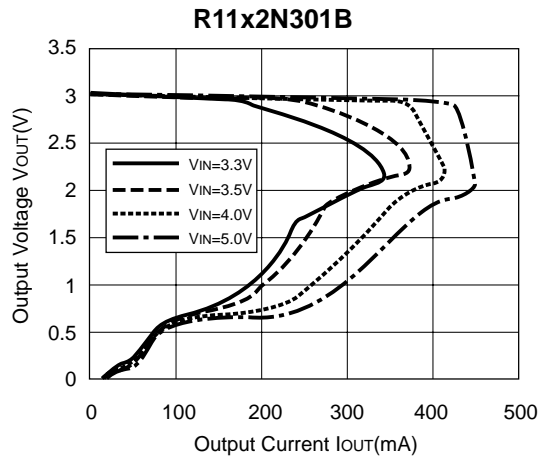
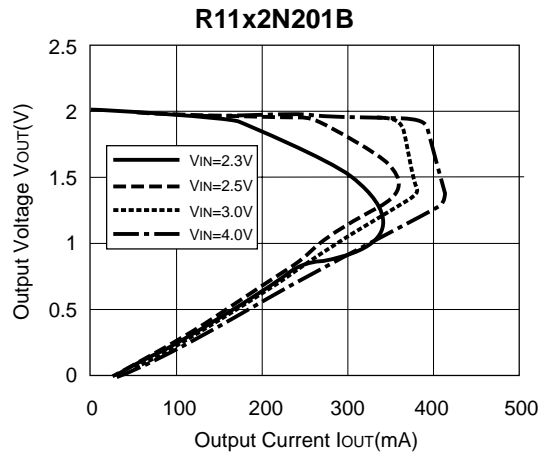
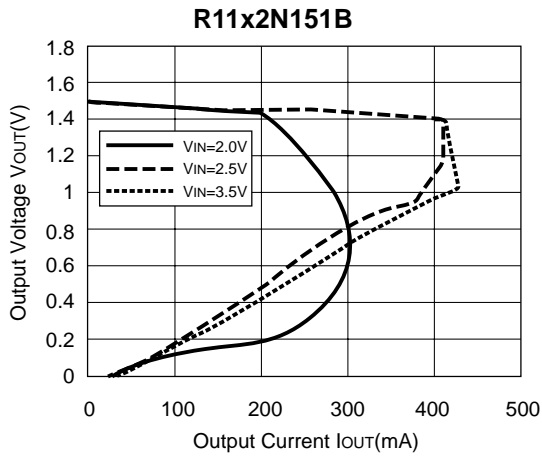

2) Output Voltage vs. Input Voltage

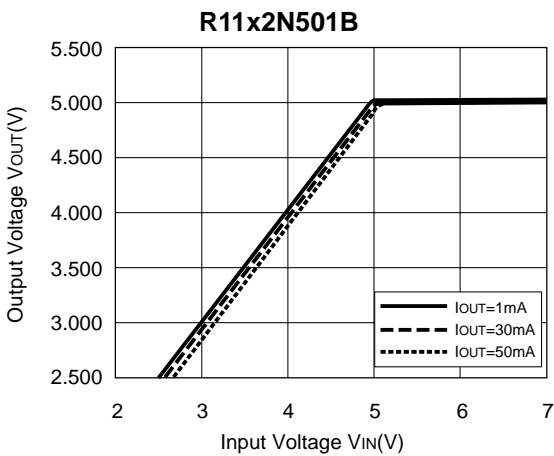
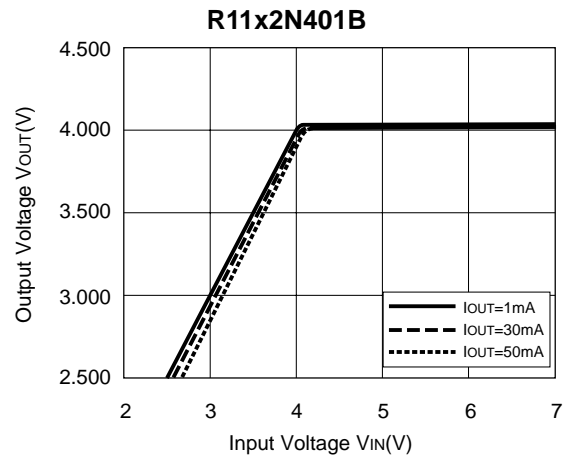
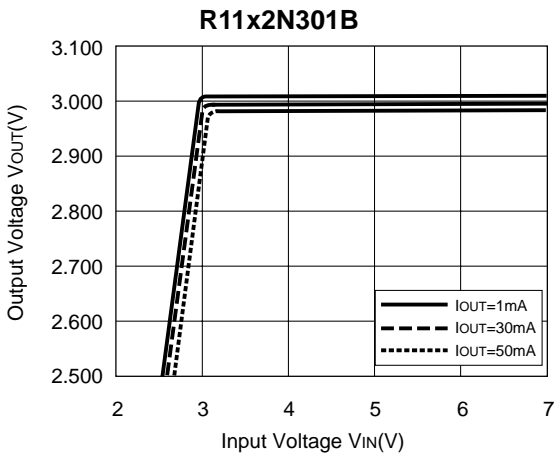
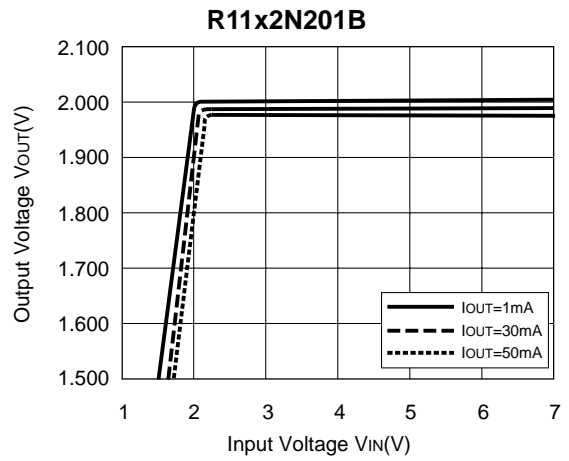
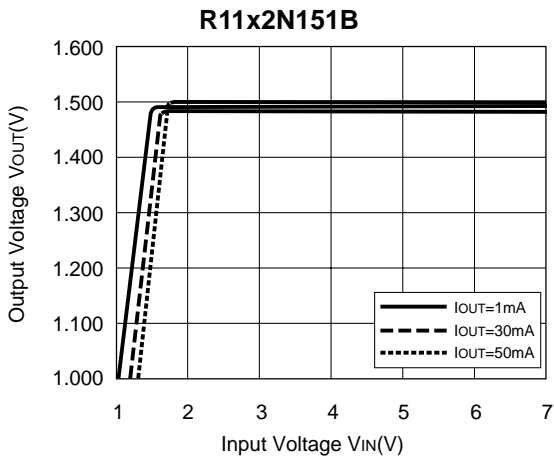

3) Dropout Voltage vs. Output Current

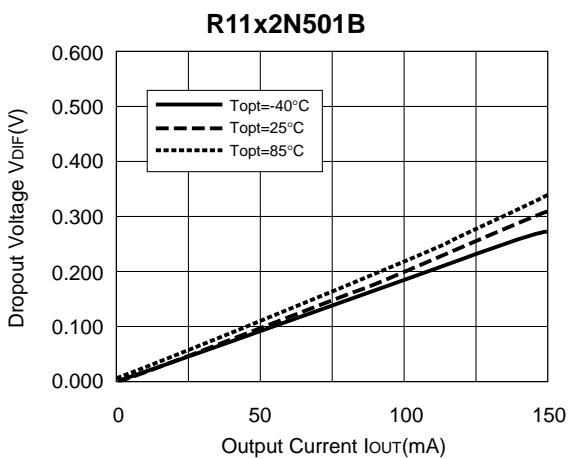
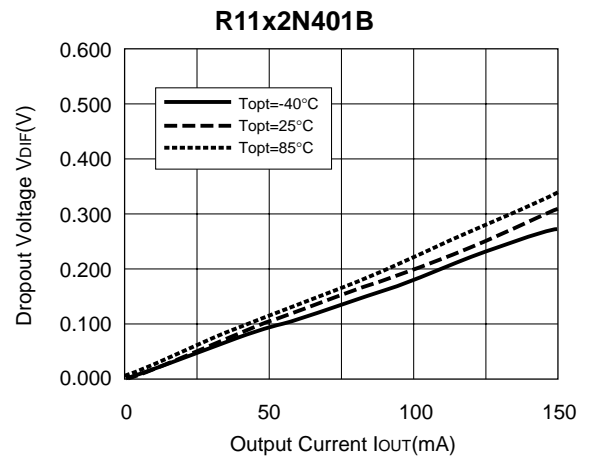
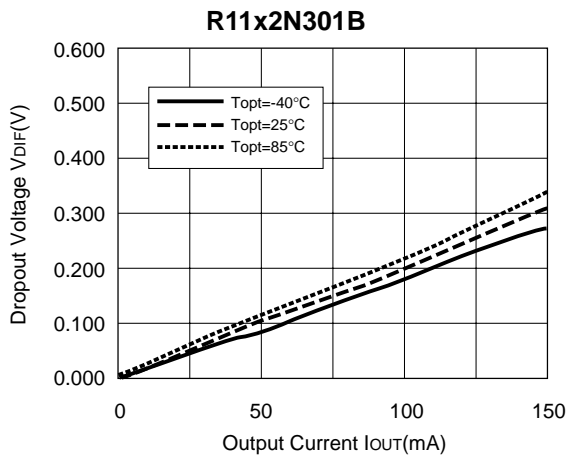
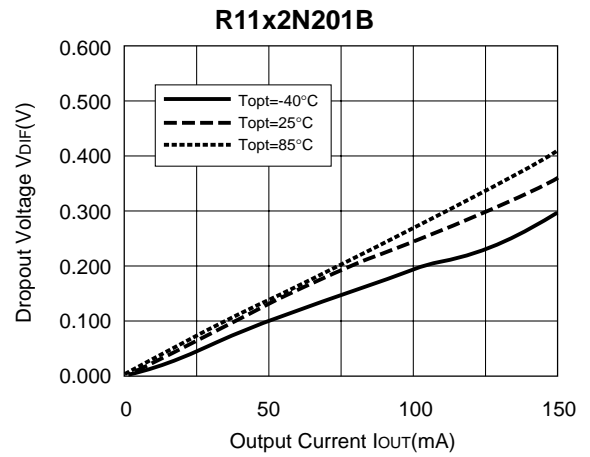
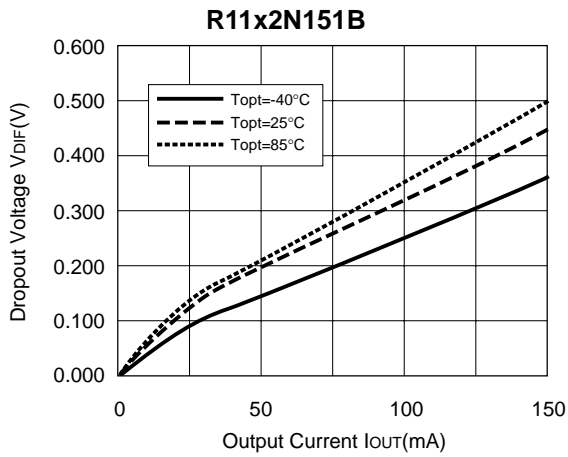

4) Output Voltage vs. Temperature

R11x2N151A/B

$V_{IN}=2.5V$ $C_{IN}=1\mu F$
 $C_{OUT}=2.2\mu F$ $I_{OUT}=30mA$

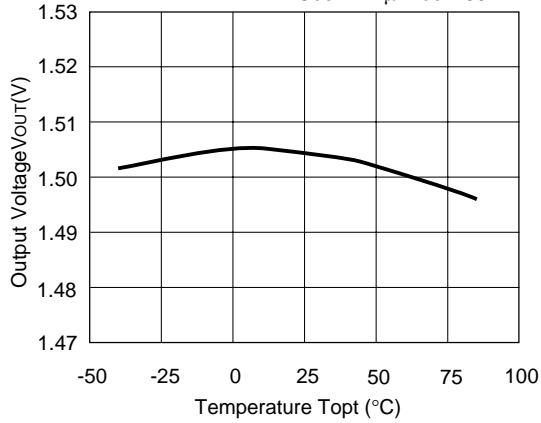

R11x2N201B

$V_{IN}=3.0V$ $C_{IN}=1\mu F$
 $C_{OUT}=2.2\mu F$ $I_{OUT}=30mA$

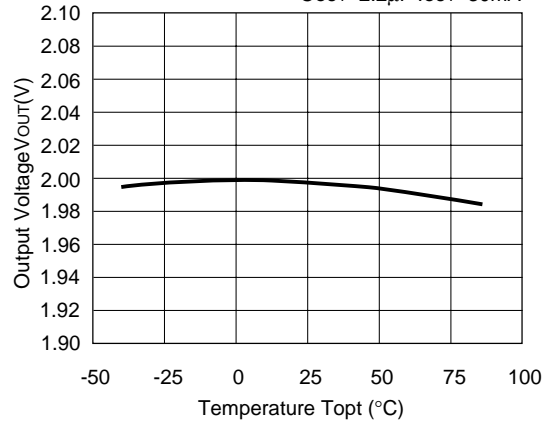

R11x2N301A/B

$V_{IN}=4.0V$ $C_{IN}=1\mu F$
 $C_{OUT}=2.2\mu F$ $I_{OUT}=30mA$

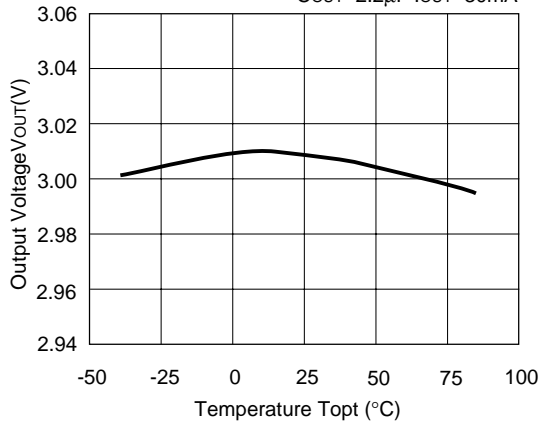

R11x2N401A/B

$V_{IN}=5.0V$ $C_{IN}=1\mu F$
 $C_{OUT}=2.2\mu F$ $I_{OUT}=30mA$

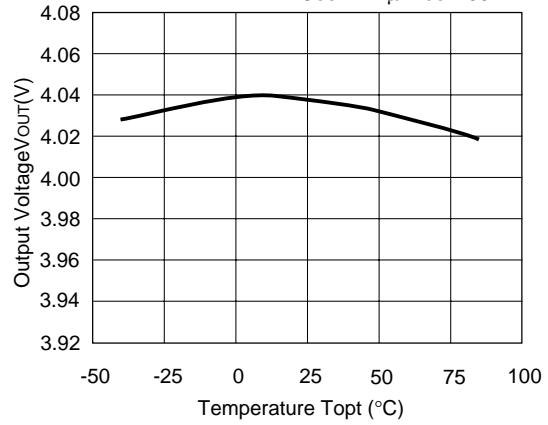

R11x2N501A/B

$V_{IN}=6.0V$ $C_{IN}=1\mu F$
 $C_{OUT}=2.2\mu F$ $I_{OUT}=30mA$

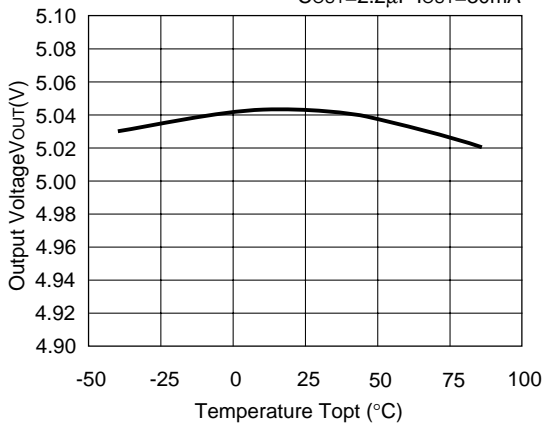

5) Supply Current vs. Input Voltage

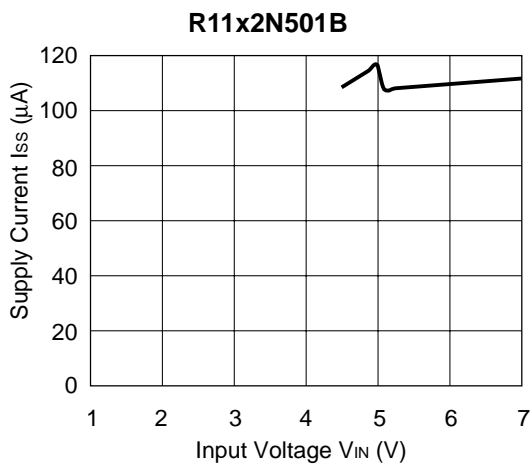
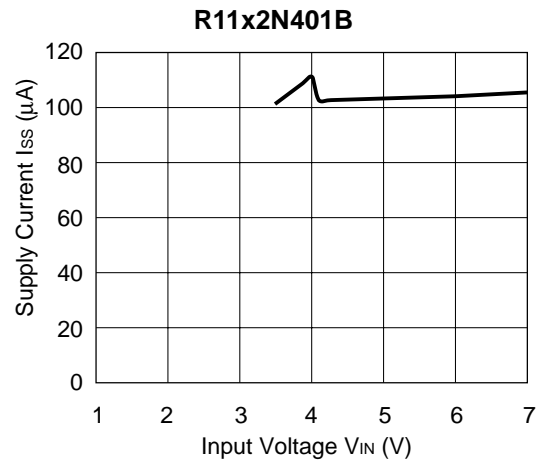
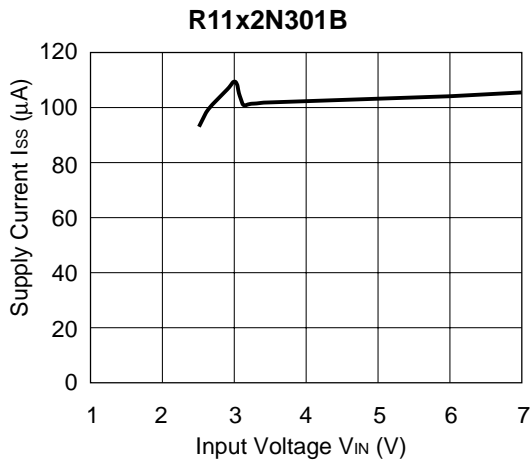
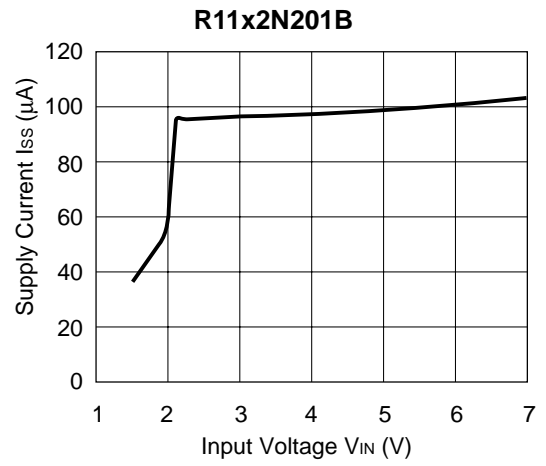
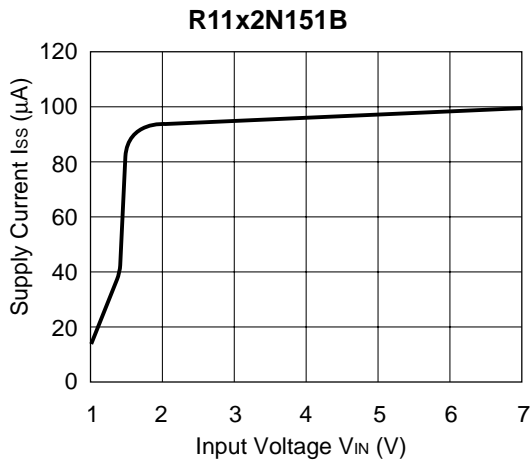

6) Supply Current vs. Temperature

R11x2N151A/B

$V_{IN}=2.5V$ $C_{IN}=1\mu F$
 $C_{OUT}=2.2\mu F$

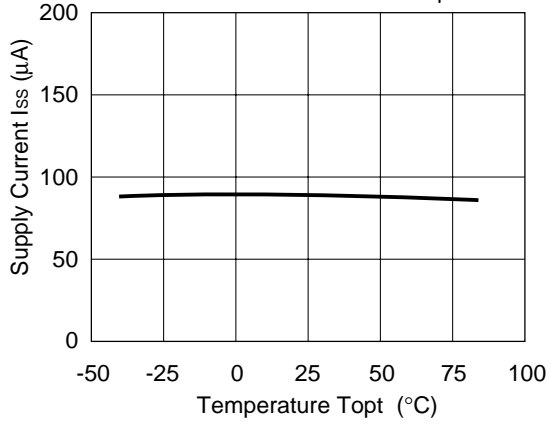

R11x2N201A/B

$V_{IN}=3.0V$ $C_{IN}=1\mu F$
 $C_{OUT}=2.2\mu F$

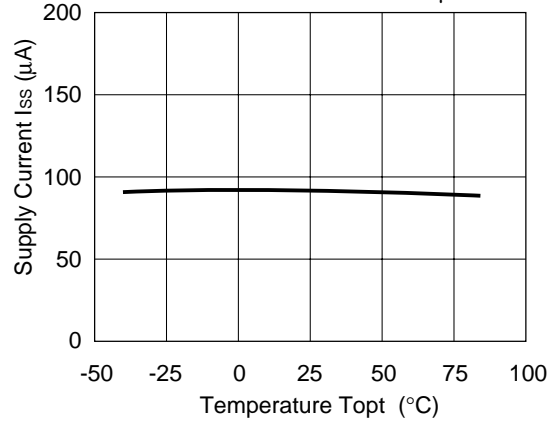

R11x2N301A/B

$V_{IN}=4.0V$ $C_{IN}=1\mu F$
 $C_{OUT}=2.2\mu F$

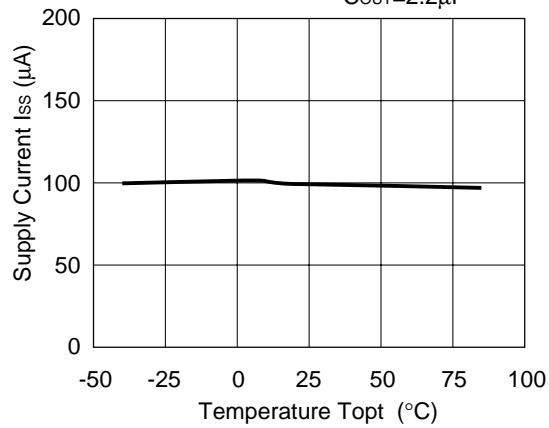

R11x2N401A/B

$V_{IN}=5.0V$ $C_{IN}=1\mu F$
 $C_{OUT}=2.2\mu F$

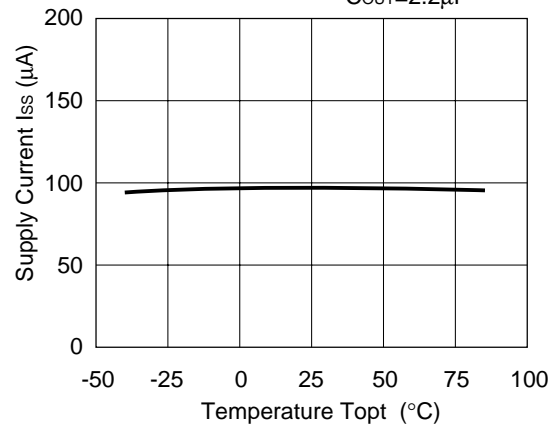

R11x2N501A/B

$V_{IN}=6.0V$ $C_{IN}=1\mu F$
 $C_{OUT}=2.2\mu F$

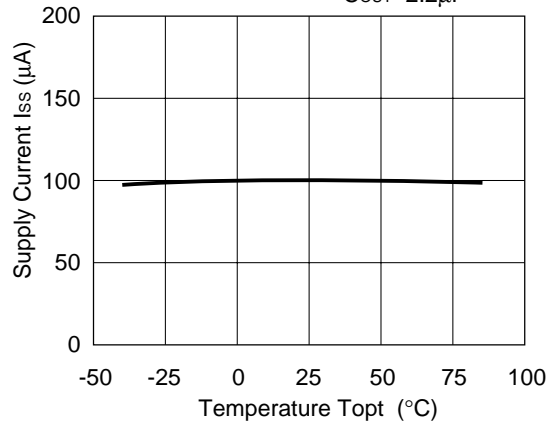

7) Ripple Rejection vs. Frequency

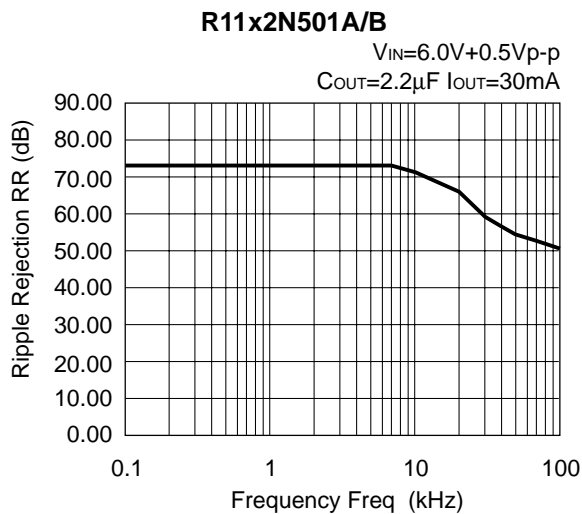
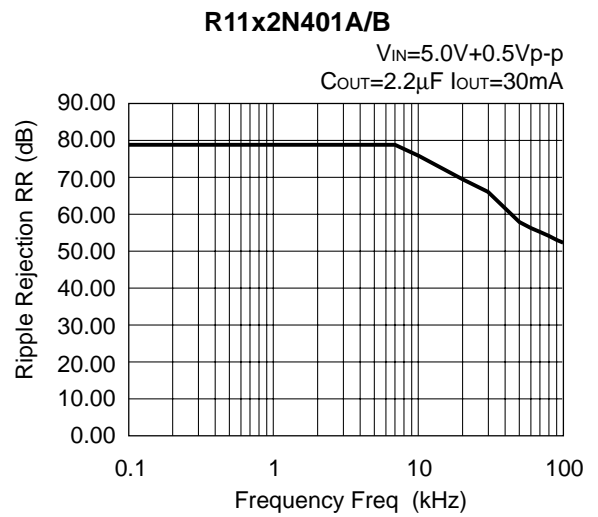
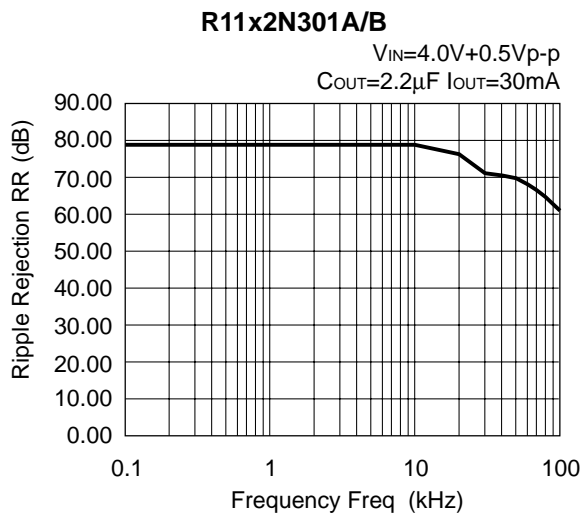
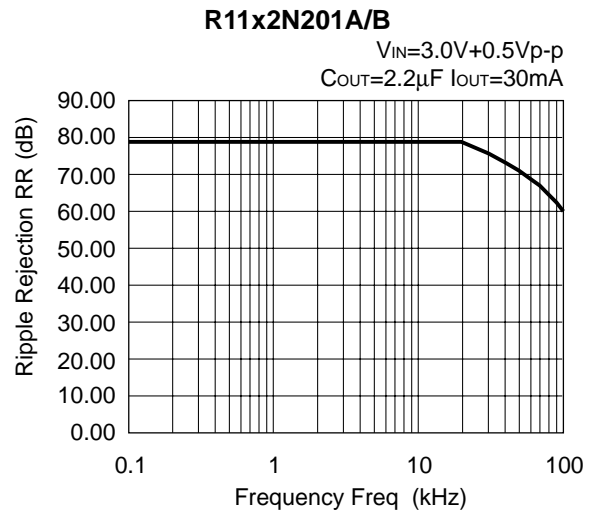
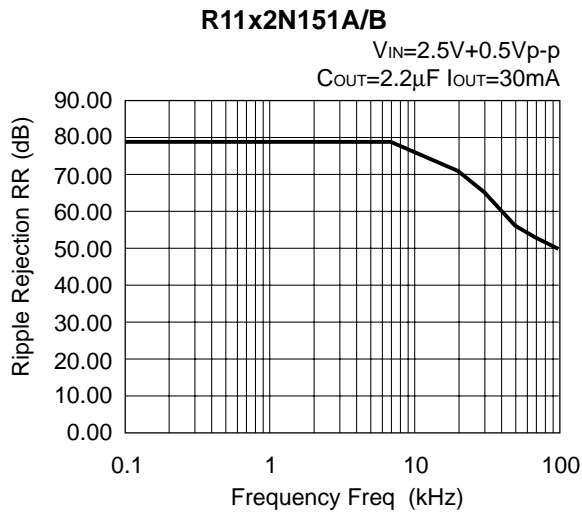

8) Ripple Rejection vs. Input Voltage (DC bias)

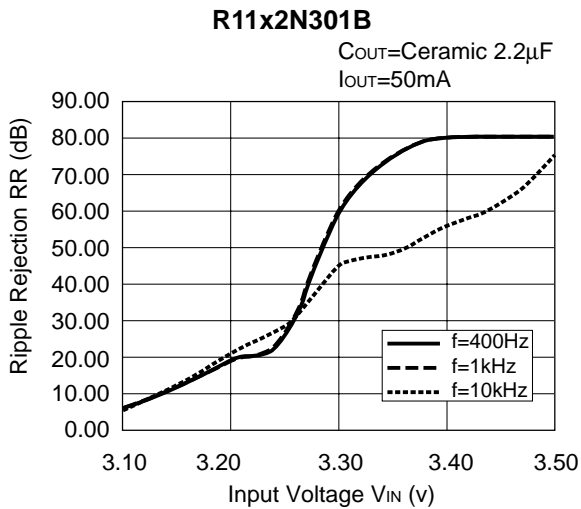
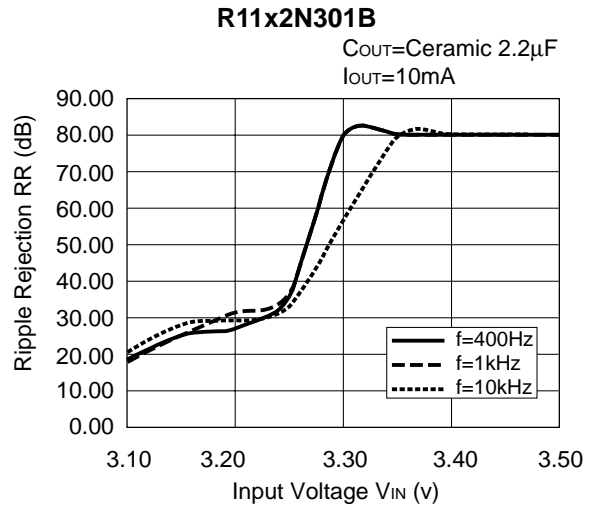
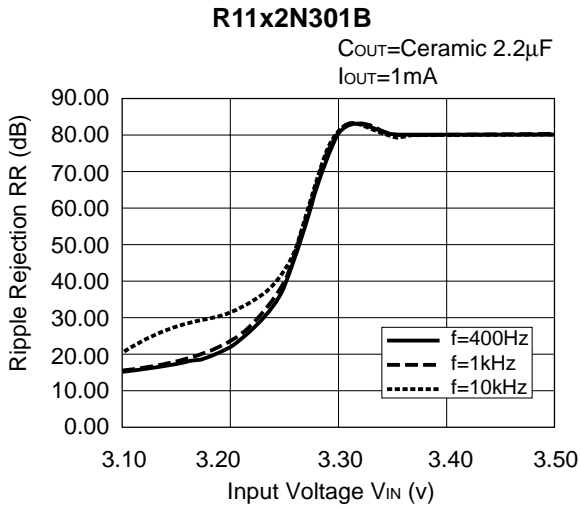

9) Input Transient Response

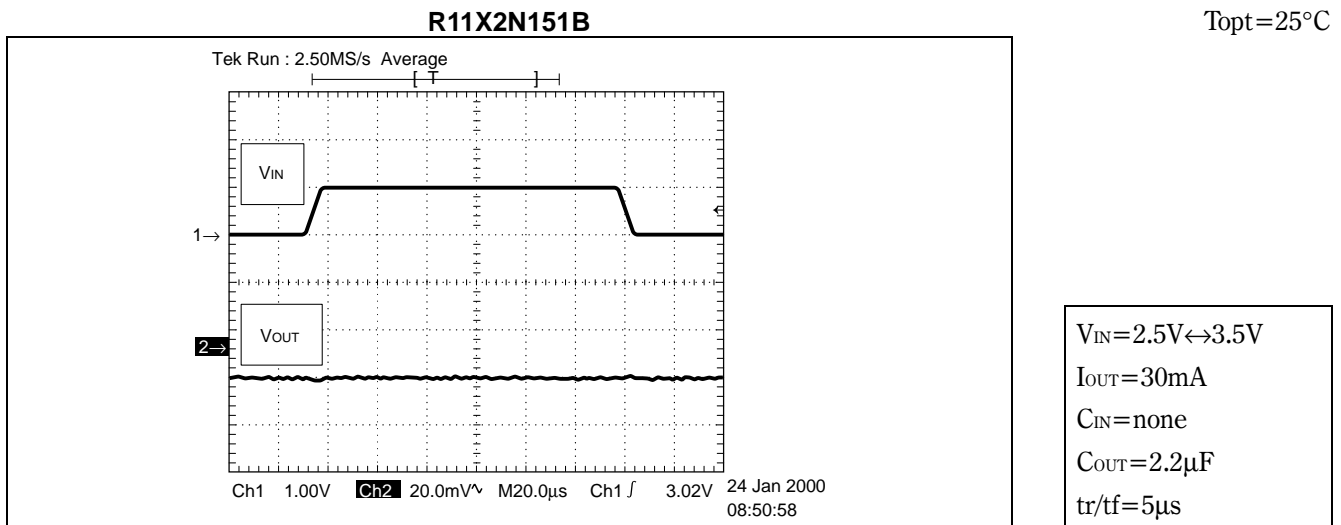

R11X2N201B

Topt=25°C

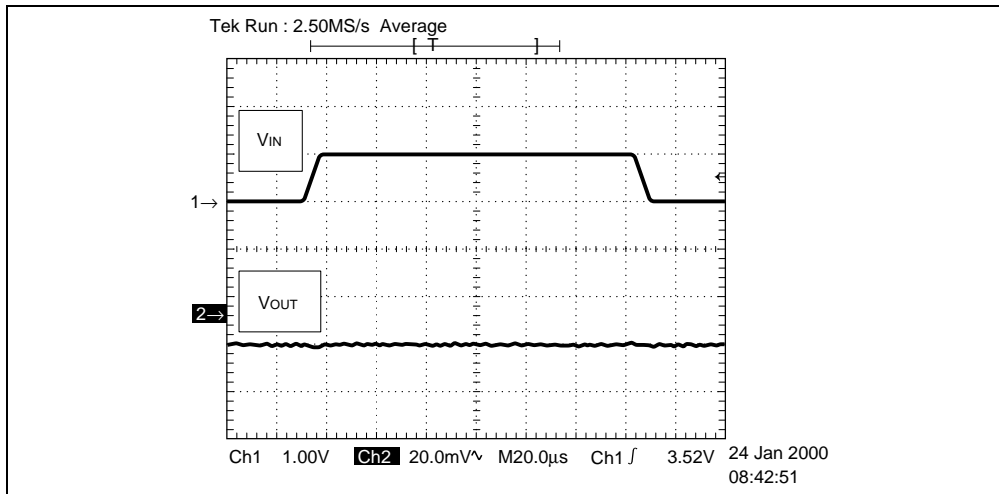
 $V_{IN}=3.0V \leftrightarrow 4.0V$ $I_{OUT}=30mA$ $C_{IN}=\text{none}$ $C_{OUT}=2.2\mu F$ $t_r/t_f=5\mu s$

R11X2N301B

Topt=25°C

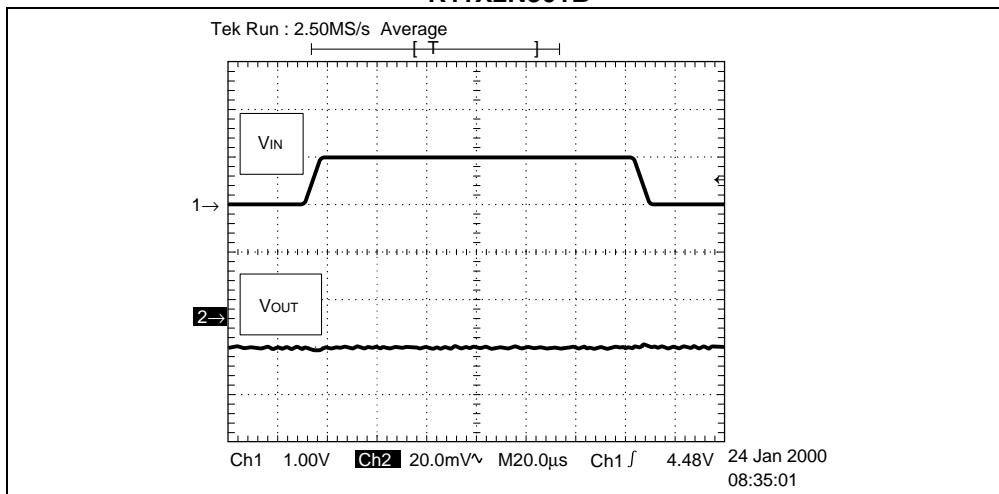
 $V_{IN}=4.0V \leftrightarrow 5.0V$ $I_{OUT}=30mA$ $C_{IN}=\text{none}$ $C_{OUT}=2.2\mu F$ $t_r/t_f=5\mu s$

R11X2N401B

Topt=25°C

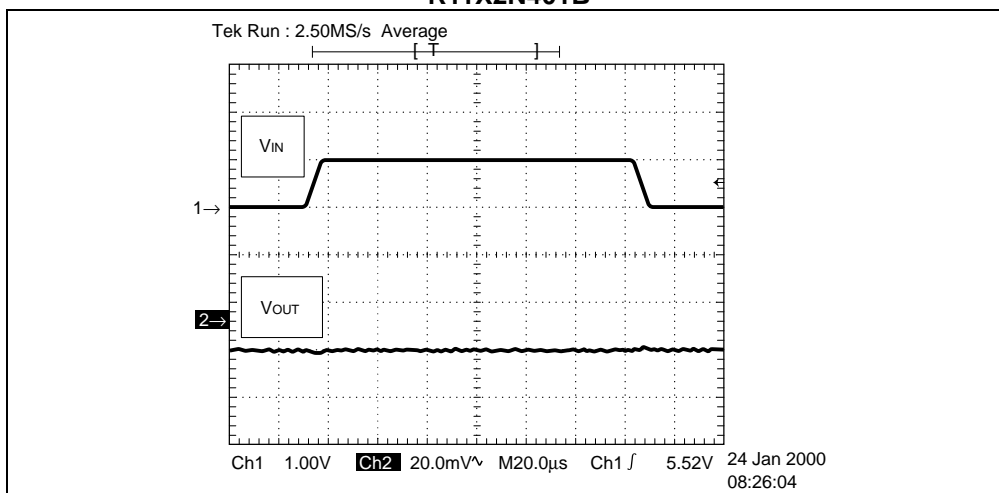
 $V_{IN}=5.0V \leftrightarrow 6.0V$ $I_{OUT}=30mA$ $C_{IN}=\text{none}$ $C_{OUT}=2.2\mu F$ $t_r/t_f=5\mu s$

R11X2N501B

$T_{opt}=25^{\circ}\text{C}$

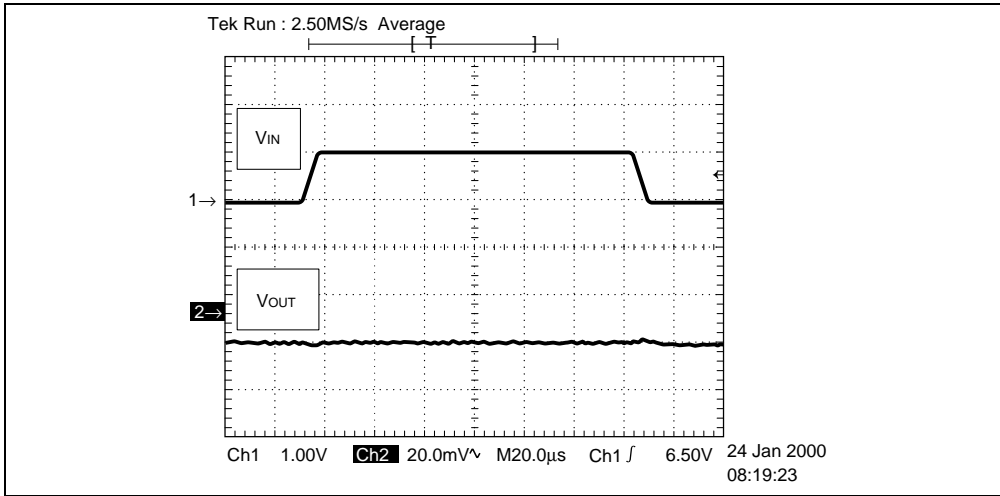

$V_{IN}=6.0\text{V}\leftrightarrow 7.0\text{V}$
 $I_{OUT}=30\text{mA}$
 $C_{IN}=\text{none}$
 $C_{OUT}=2.2\mu\text{F}$
 $t_r/t_f=5\mu\text{s}$

10) Load Transient Response

R11X2N151B

$T_{opt}=25^{\circ}\text{C}$

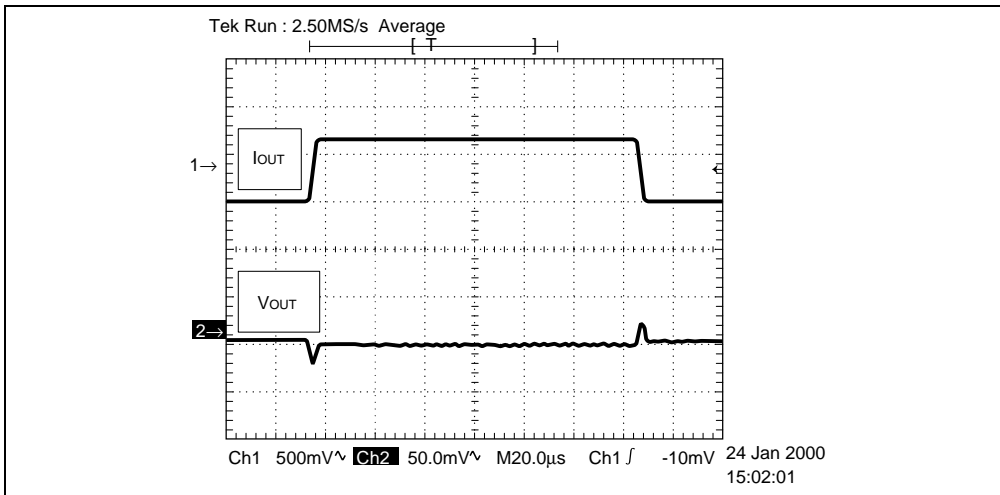

$I_{OUT}=50\text{mA}\leftrightarrow 100\text{mA}$
 $V_{IN}=2.5\text{V}$
 $C_{IN}=2.2\mu\text{F}$
 $C_{OUT}=2.2\mu\text{F}$
 $t_r/t_f=5\mu\text{s}$

R11X2N201B

$T_{opt}=25^{\circ}\text{C}$

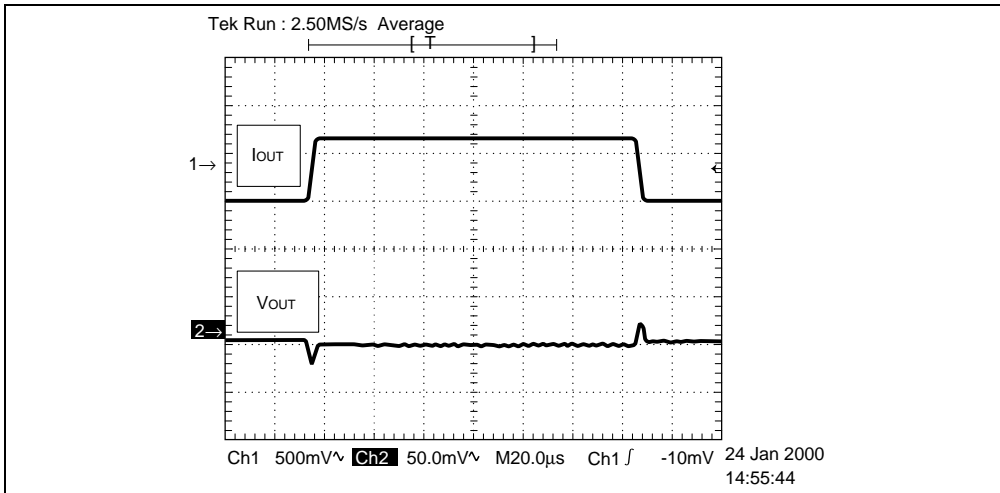

$I_{OUT}=50\text{mA}\leftrightarrow 100\text{mA}$
 $V_{IN}=3.0\text{V}$
 $C_{IN}=2.2\mu\text{F}$
 $C_{OUT}=2.2\mu\text{F}$
 $t_r/t_f=5\mu\text{s}$

R11X2N301B

$T_{opt}=25^{\circ}\text{C}$

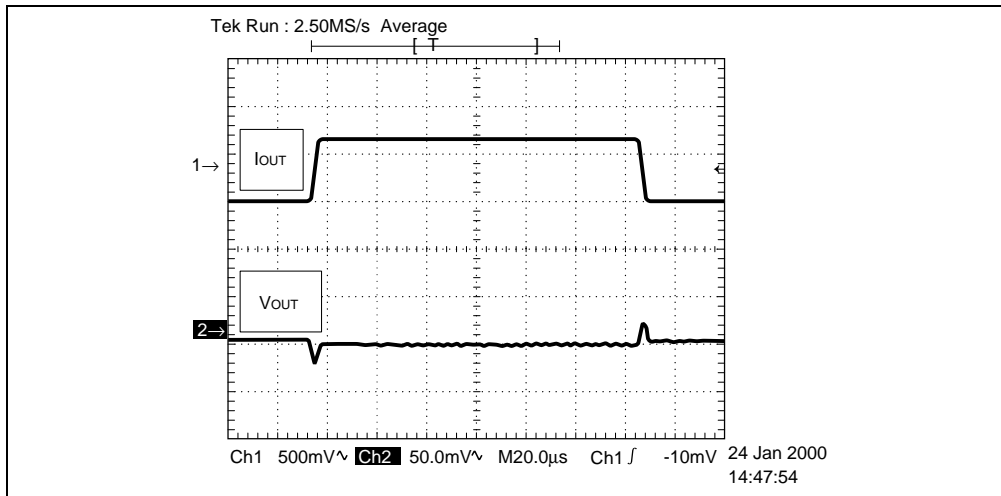

$I_{OUT}=50\text{mA}\leftrightarrow 100\text{mA}$
 $V_{IN}=4.0\text{V}$
 $C_{IN}=2.2\mu\text{F}$
 $C_{OUT}=2.2\mu\text{F}$
 $t_r/t_f=5\mu\text{s}$

R11X2N401B

$T_{opt}=25^{\circ}\text{C}$

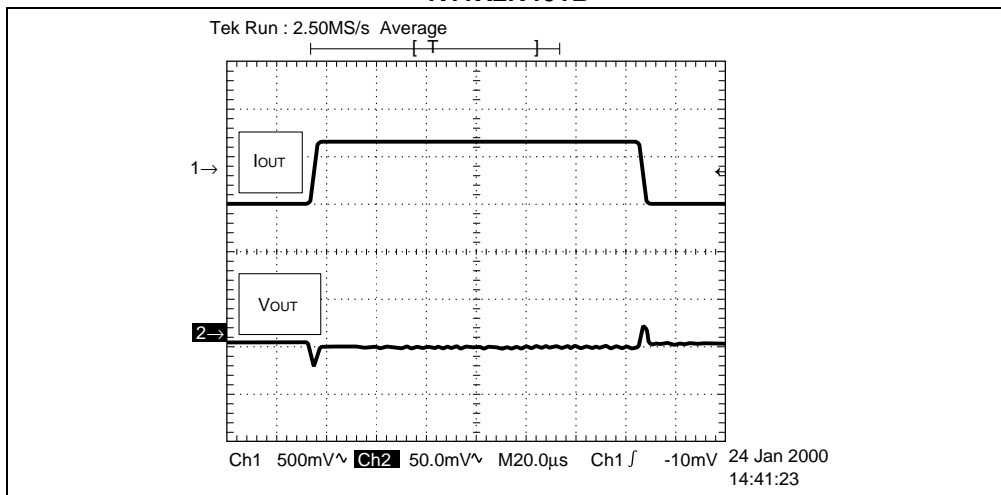

$I_{OUT}=50\text{mA}\leftrightarrow 100\text{mA}$
 $V_{IN}=5.0\text{V}$
 $C_{IN}=2.2\mu\text{F}$
 $C_{OUT}=2.2\mu\text{F}$
 $t_r/t_f=5\mu\text{s}$

R11X2N501B

$T_{opt}=25^{\circ}\text{C}$

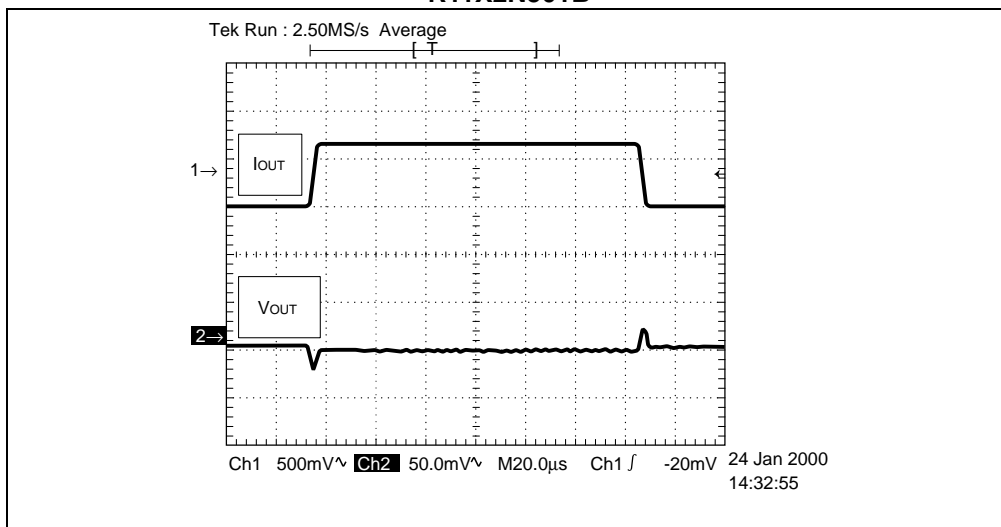

$I_{OUT}=50\text{mA}\leftrightarrow 100\text{mA}$
 $V_{IN}=6.0\text{V}$
 $C_{IN}=2.2\mu\text{F}$
 $C_{OUT}=2.2\mu\text{F}$
 $t_r/t_f=5\mu\text{s}$

TECHNICAL NOTES

When using these ICs, consider the following points:

In these ICs, phase compensation is made for securing stable operation even if the load current is varied. For this purpose, be sure to use a capacitor C_{OUT} with good frequency characteristics and ESR (Equivalent Series Resistance) of which is in the range described as follows:

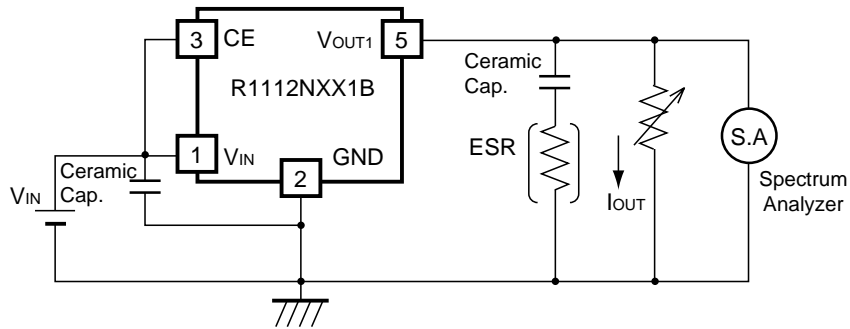

Measuring Circuit for white noise; R1112NXX1B

The relations between I_{OUT} (Output Current) and ESR of Output Capacitor are shown below. The conditions when the white noise level is under $40\mu V$ (Avg.) are marked as the hatched area in the graph.

(note: When the additional ceramic capacitors are connected to the Output Pin with Output capacitor for phase compensation, the operation might be unstable. Because of this, test these ICs with as same external components as ones to be used on the PCB.)

<measuring conditions>

- (1) $V_{IN} = V_{OUT} + 1V$
- (2) Frequency band: 10Hz to 1MHz
- (3) Temperature: $25^{\circ}C$

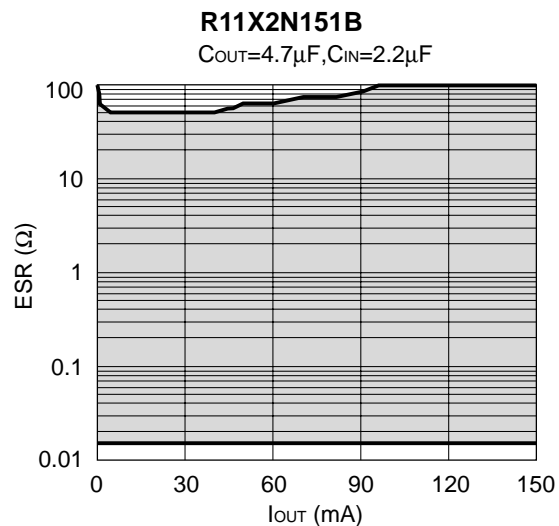
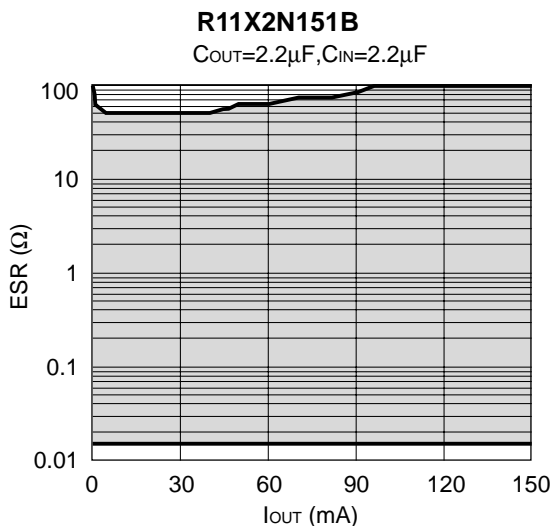

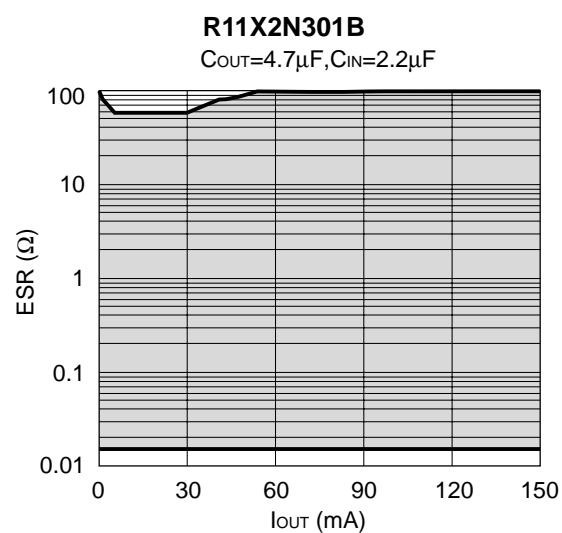
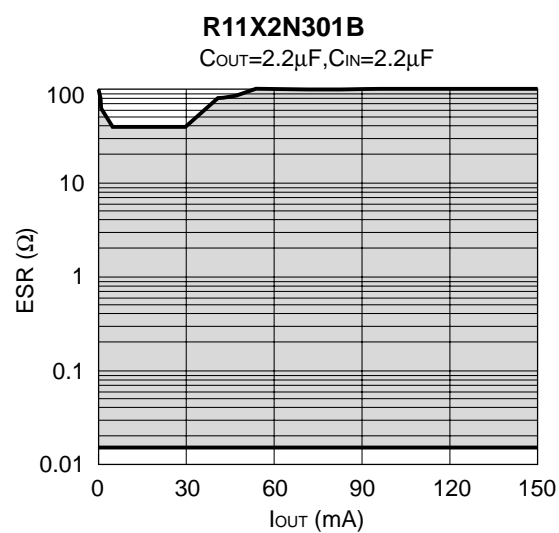

- Make V_{DD} and GND line sufficient. When the impedance of these is high, the noise might be picked up or not work correctly.
- Connect the capacitor with a capacitance of $2.2\mu F$ or more between V_{DD} and GND as close as possible.
- Set external components, especially Output Capacitor, as close as possible to the ICs and make wiring shortest.