

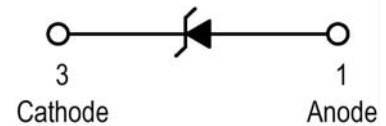

Zener diode

Features

1. High reliability
2. Wide voltage range available
3. Low reverse current level
4. Small outline package for space savings
5. Surface mount package

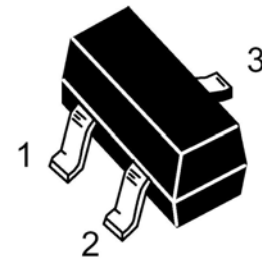

Applications

Voltage stabilization

Absolute Maximum Ratings

$T_j=25^\circ\text{C}$

Parameter	Test Conditions	Type	Symbol	Value	Unit
Power dissipation	$T_{amb} \leq 75^\circ\text{C}$		P_V	410	mW
Z-current			I_Z	P_V/V_Z	mA
Junction temperature			T_j	150	$^\circ\text{C}$
Storage temperature range			T_{stg}	-55~+150	$^\circ\text{C}$

Maximum Thermal Resistance

$T_j=25^\circ\text{C}$

Parameter	Test Conditions	Symbol	Value	Unit
Junction ambient	$l=9.5\text{mm}(3/8") T_L=\text{constant}$	R_{thJA}	300	K/W

Stresses exceeding maximum ratings may damage the device. Maximum ratings are stress ratings only. Functional operation above the recommended operating conditions is not implied. Extended exposure to stresses above the recommended operating conditions may affect device reliability.

Electrical Characteristics

$T_j=25^\circ\text{C}$

Parameter	Test Conditions	Type	Symbol	Min	Typ	Max	Unit
Forward voltage	$I_F=10\text{mA}$		V_F			0.9	V

Excel Semiconductor



Type	Marking	V_{Znom}	I_{ZT}	for V_{ZT} &		r_{zIT}	r_{zIK} at	I_{ZK}	I_R & I_R at V_R		TK_{VZ}
BZX84C		V	mA	$V^{(1)}$	Ω	Ω	mA	μA	V	%/K	
2V4	Z11	2.4	5	2.2~2.6	<100	<600	1	<50	1	-0.09~-0.06	
2V7	Z12	2.7	5	2.5~2.9	<100	<600	1	<20	1	-0.09~-0.06	
3V0	Z13	3.0	5	2.8~3.2	<95	<600	1	<10	1	-0.08~-0.05	
3V3	Z14	3.3	5	3.1~3.5	<95	<600	1	<5	1	-0.08~-0.05	
3V6	Z15	3.6	5	3.4~3.8	<90	<600	1	<5	1	-0.08~-0.05	
3V9	Z16	3.9	5	3.7~4.1	<90	<600	1	<3	1	-0.08~-0.05	
4V3	W9	4.3	5	4.0~4.6	<90	<600	1	<3	1	-0.06~-0.03	
4V7	Z1	4.7	5	4.4~5.0	<80	<500	1	<3	2	-0.05~+0.02	
5V1	Z2	5.1	5	4.8~5.4	<60	<480	1	<2	2	-0.02~+0.02	
5V6	Z3	5.6	5	5.2~6.0	<40	<400	1	<1	2	-0.05~+0.05	
6V2	Z4	6.2	5	5.8~6.6	<10	<150	1	<3	4	0.03~0.06	
6V8	Z5	6.8	5	6.4~7.2	<15	<80	1	<2	4	0.03~0.07	
7V5	Z6	7.5	5	7.0~7.9	<15	<80	1	<1	5	0.03~0.07	
8V2	Z7	8.2	5	7.7~8.7	<15	<80	1	<0.7	5	0.03~0.08	
9V1	Z8	9.1	5	8.5~9.6	<15	<100	1	<0.5	6	0.03~0.09	
10	Z9	10	5	9.4~10.6	<20	<150	1	<0.2	7	0.03~0.1	
11	Y1	11	5	10.4~11.6	<20	<150	1	<0.1	8	0.03~0.11	
12	Y2	12	5	11.4~12.7	<25	<150	1	<0.1	8	0.03~0.11	
13	Y3	13	5	12.4~14.1	<30	<170	1	<0.1	8	0.03~0.11	
15	Y4	15	5	13.8~15.6	<30	<200	1	<0.05	10.5	0.03~0.11	
16	Y5	16	5	15.3~17.1	<40	<200	1	<0.05	11.2	0.03~0.11	
18	Y6	18	5	16.8~19.1	<45	<225	1	<0.05	12.6	0.03~0.11	
20	Y7	20	5	18.8~21.2	<55	<225	1	<0.05	14	0.03~0.11	
22	Y8	22	5	20.8~23.3	<55	<250	1	<0.05	15.4	0.04~0.12	
24	Y9	24	5	22.8~25.6	<70	<250	1	<0.05	16.8	0.04~0.12	
27	Y10	27	5	25.1~28.9	<80	<300	1	<0.05	18.9	0.04~0.12	
30	Y11	30	5	28~32	<80	<300	1	<0.05	21	0.04~0.12	
33	Y12	33	5	31~35	<80	<325	1	<0.05	23.1	0.04~0.12	
36	Y13	36	5	34~38	<90	<350	1	<0.05	25.2	0.04~0.12	
39	Y14	39	2.5	37~41	<130	<350	0.5	<0.05	27.3	0.04~0.12	
43	Y15	43	2.5	40~46	<150	<375	0.5	<0.05	30.1	0.04~0.12	
47	Y16	47	2.5	44~50	<170	<375	0.5	<0.05	32.9	0.04~0.12	
51	Y17	51	2.5	48~54	<180	<400	0.5	<0.05	35.7	0.04~0.12	
56	Y18	56	2.5	52~60	<200	<425	0.5	<0.05	39.2	0.04~0.12	
62	Y19	62	2.5	58~66	<215	<450	0.5	<0.05	43.4	0.04~0.12	
68	Y20	68	2.5	64~72	<240	<475	0.5	<0.05	47.6	0.04~0.12	
75	Y21	75	2.5	70~79	<255	<500	0.5	<0.05	52.5	0.04~0.12	



Characteristics ($T_j=25^\circ\text{C}$ unless otherwise specified)

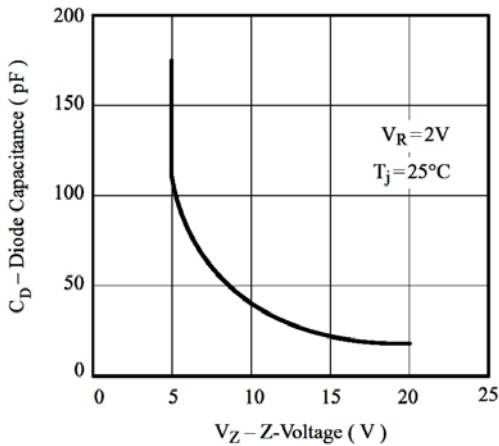

Figure 1. Diode Capacitance vs. Z-voltage

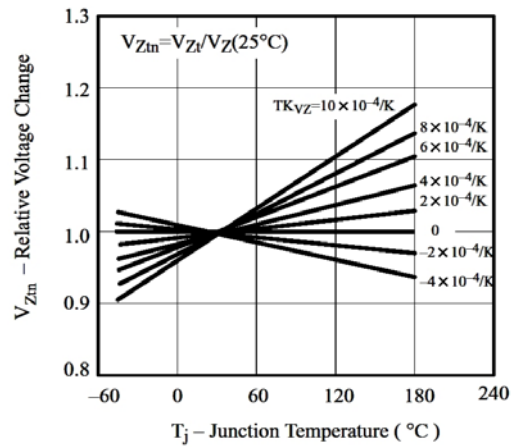

Figure 2. Typical Change of Working Voltage Vs. Junction Temperature

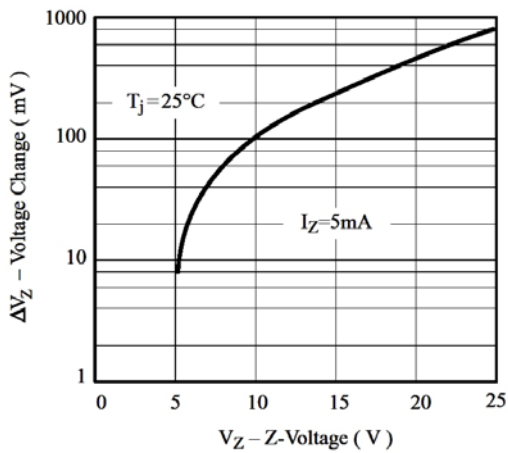

Figure 3. Typical Change of Working Voltage under Operating Conditions at $T_{amb}=25^\circ\text{C}$

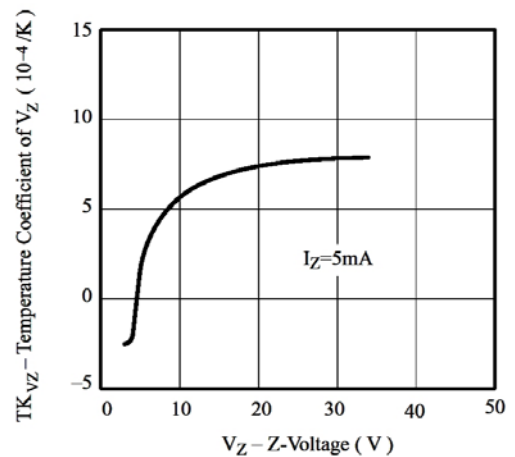

Figure 4. Temperature Coefficient of V_Z vs. Z-Voltage

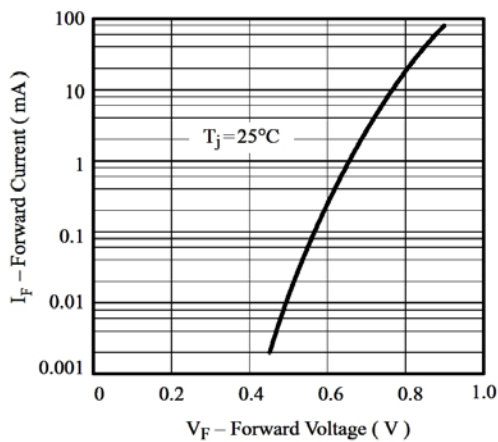

Figure 5. Forward Current vs. Forward Voltage

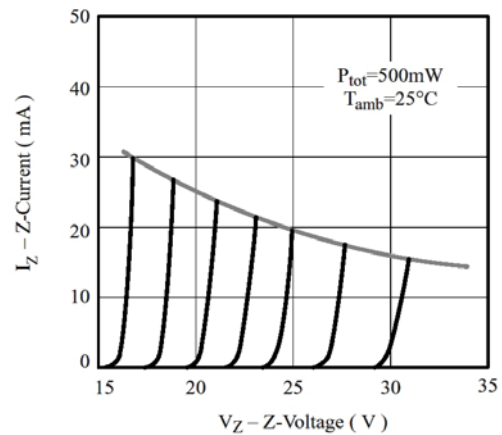

Figure 6. Z-Current vs. Z-Voltage

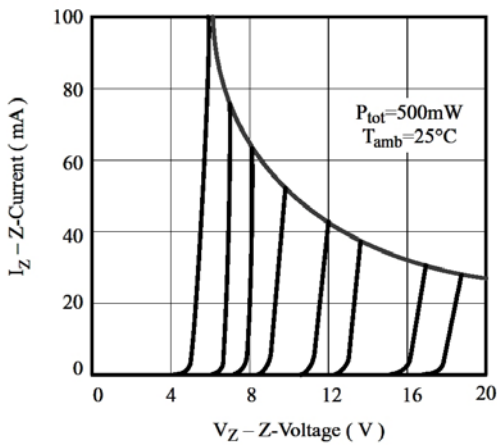

Figure 7. Z-Current vs. Z-Voltage

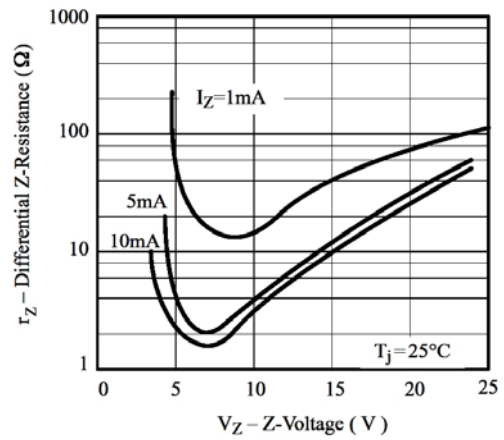

Figure 8. Differential Z-Resistance Vz vs. Z-Voltage

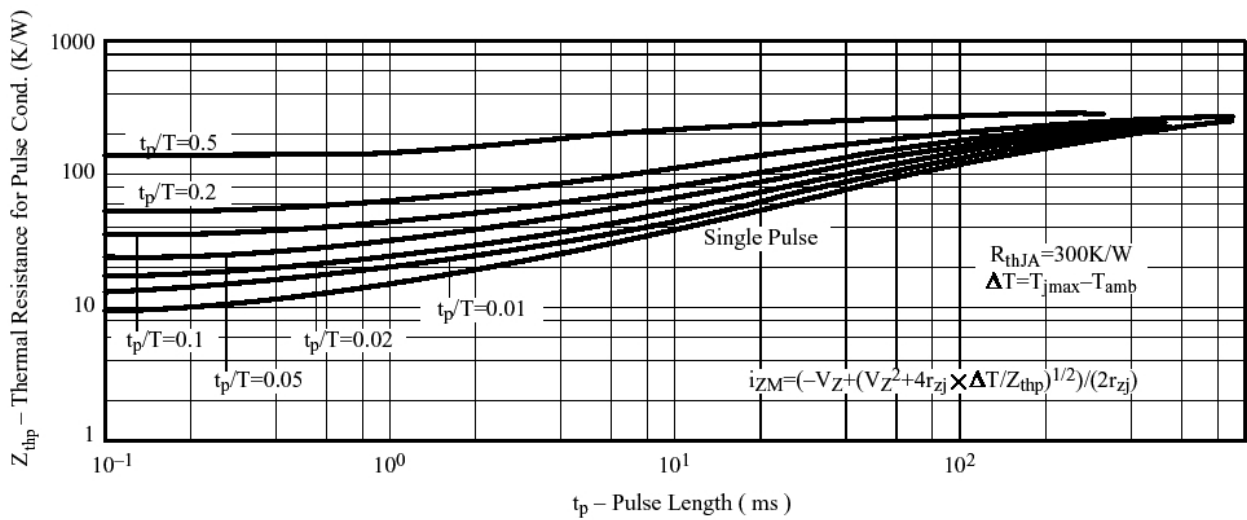
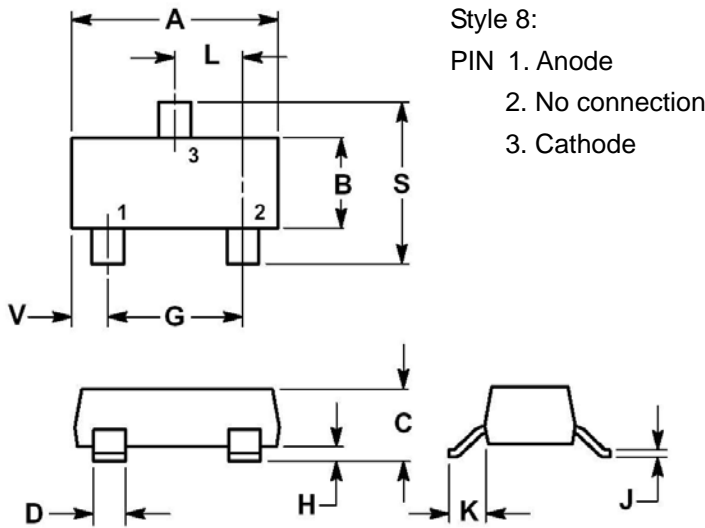

Figure 9. Thermal Response



Dimensions



DIM	INCHES		MILLIMETERS	
	MIN	MAX	MIN	MAX
A	0.1102	0.1197	2.80	3.04
B	0.0472	0.0551	1.20	1.40
C	0.0350	0.0440	0.89	1.11
D	0.0150	0.0200	0.37	0.50
G	0.0701	0.0807	1.78	2.04
H	0.0005	0.0040	0.013	0.100
J	0.0034	0.0070	0.085	0.177
K	0.0180	0.0236	0.45	0.60
L	0.0350	0.0401	0.89	1.02
S	0.0830	0.0984	2.10	2.50
V	0.0177	0.0236	0.45	0.60

Notes:

1. Dimensioning and tolerance per ANSI Y14.5M, 1982.
2. Controlling dimension: inch.
3. Maximum lead thickness includes lead finish thickness. Minimum lead thickness is the minimum thickness of base material.

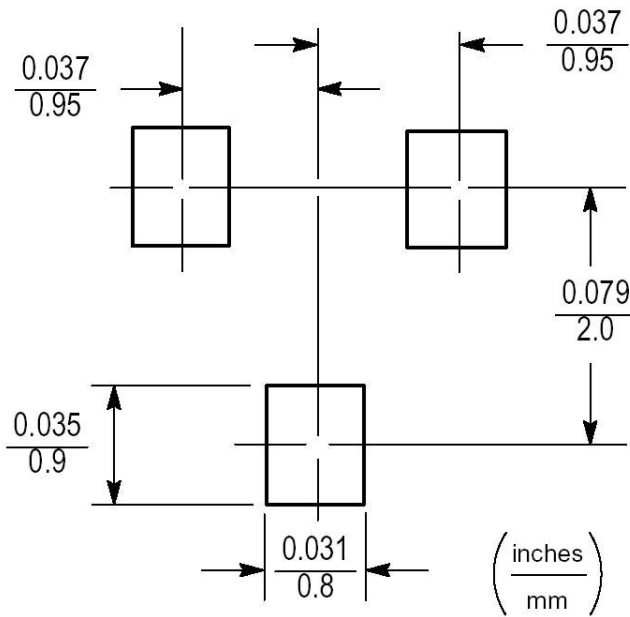

SOT-23 Footprint