



# 1.3W, Filterless, Stereo Class D Audio Power Amplifier

MAX9701

## General Description

The MAX9701 stereo Class D audio power amplifier provides Class AB amplifier audio performance with the benefits of Class D efficiency, eliminating the need for a heatsink while extending battery life. The MAX9701 delivers up to 1.3W per channel into an 8Ω load while offering 87% efficiency. Maxim's next-generation, low-EMI modulation scheme allows the amplifier to operate without an external LC filter while still meeting FCC EMI emission levels.

The MAX9701 offers two modulation schemes: a fixed-frequency (FFM) mode, and a spread-spectrum (SSM) mode that reduces EMI-radiated emissions. The MAX9701 oscillator can be synchronized to an external clock through the SYNC input, allowing synchronization of multiple Maxim Class D amplifiers. The sync output (SYNC\_OUT) can be used for a master-slave application where more channels are required. The MAX9701 features a fully differential architecture, a full bridge-tied load (BTL) output, and comprehensive click-and-pop suppression. The device features internally set gains of 0dB, 6dB, 12dB, and 18dB selected through two gain-select inputs, further reducing external component count.

The MAX9701 features high 80dB PSRR, less than 0.1% THD+N, and SNR in excess of 88dB. Short-circuit and thermal-overload protection prevent the device from being damaged during a fault condition. The MAX9701 is available in 24-pin thin QFN-EP (4mm x 4mm x 0.8mm) and 20-bump UCSP™ (2mm x 2.5mm x 0.6mm) packages. The MAX9701 is specified over the extended -40°C to +85°C temperature range.

## Applications

Cellular Phones  
Notebooks  
Handheld Gaming Consoles  
Docking Stations  
MP3 Players

*Pin Configurations appear at end of data sheet.*

*UCSP is a trademark of Maxim Integrated Products, Inc.*



## Features

- ◆ Spread-Spectrum Modulation Lowers Radiated Emissions
- ◆ Single-Supply Operation (2.5V to 5.5V)
- ◆ 1.3W Stereo Output (8Ω, V<sub>DD</sub> = 5V, THD+N = 1%)
- ◆ No LC Output Filter Required
- ◆ 87% Efficiency (R<sub>L</sub> = 8Ω, P<sub>OUT</sub> = 1000mW)
- ◆ Less Than 0.1% THD+N
- ◆ High 80dB PSRR
- ◆ Fully Differential Inputs
- ◆ Integrated Click-and-Pop Suppression
- ◆ Typical Low Quiescent Current (9mA)
- ◆ Typical Low-Power Shutdown Mode (0.1μA)
- ◆ Short-Circuit and Thermal-Overload Protection
- ◆ Available in Thermally Efficient, Space-Saving Packages
  - 24-Pin Thin QFN-EP (4mm x 4mm x 0.8mm)
  - 20-Bump UCSP (2mm x 2.5mm x 0.6mm)

## Ordering Information

PART	TEMP RANGE	PIN-PACKAGE
MAX9701EBP+TG45	-40°C to +85°C	20 UCSP
MAX9701ETG+	-40°C to +85°C	24 TQFN-EP*

+ Denotes lead(Pb)-free/RoHS-compliant package.

\*EP = Exposed pad.

## Block Diagram

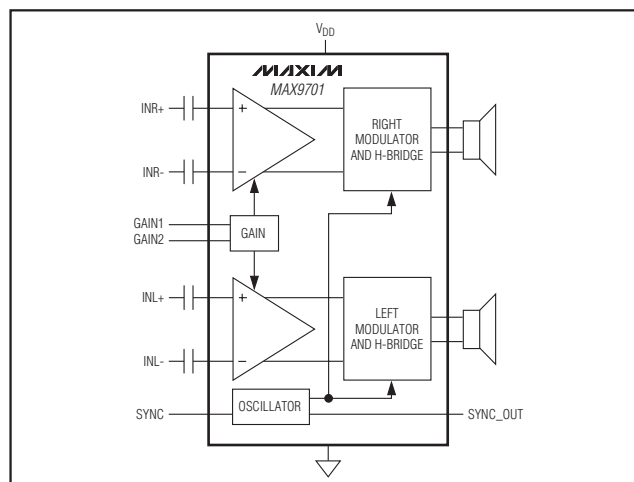

# 1.3W, Filterless, Stereo Class D Audio Power Amplifier

## ABSOLUTE MAXIMUM RATINGS

V <sub>DD</sub> to GND	6V
V <sub>DD</sub> to PV <sub>DD</sub>	-0.3V to +0.3V
PV <sub>DD</sub> to PGND	6V
GND to PGND	-0.3V to +0.3V
All Other Pins to GND	-0.3V to (V <sub>DD</sub> + 0.3V)
Continuous Current In/Out of PV <sub>DD</sub> , PGND, OUT <sub>-</sub>	±800mA
Continuous Input Current (all other pins)	±20mA
Duration of OUT <sub>-</sub> Short Circuit to GND or PV <sub>DD</sub>	Continuous
Duration of Short Circuit Between OUT <sub>+</sub> and OUT <sub>-</sub>	Continuous

Continuous Power Dissipation (T <sub>A</sub> = +70°C)	
20-Bump UCSP (derate 10mW/°C above +70°C)	800mW
24-Pin Thin QFN (derate 20.8mW/°C above +70°C)	1666.7mW
Junction Temperature	+150°C
Operating Temperature Range	-40°C to +85°C
Storage Temperature Range	-65°C to +150°C
Bump Temperature (soldering)	+235°C
Lead Temperature (soldering, 10s)	+300°C

Stresses beyond those listed under "Absolute Maximum Ratings" may cause permanent damage to the device. These are stress ratings only, and functional operation of the device at these or any other conditions beyond those indicated in the operational sections of the specifications is not implied. Exposure to absolute maximum rating conditions for extended periods may affect device reliability.

## ELECTRICAL CHARACTERISTICS

(V<sub>DD</sub> = PV<sub>DD</sub> =  $\overline{\text{SHDN}}$  = 3.3V, GND = PGND = 0V, SYNC = 0V (FFM), gain = 6dB (GAIN1 = 0, GAIN2 = 1), R<sub>L</sub> connected between OUT<sub>+</sub> and OUT<sub>-</sub>, R<sub>L</sub> = ∞, T<sub>A</sub> = T<sub>MIN</sub> to T<sub>MAX</sub>, unless otherwise noted. Typical values are at T<sub>A</sub> = +25°C.) (Notes 1, 2)

PARAMETER	SYMBOL	CONDITIONS	MIN	TYP	MAX	UNITS	
<b>GENERAL</b>							
Supply Voltage Range	V <sub>DD</sub>	Inferred from PSRR test	2.5		5.5	V	
Quiescent Current	I <sub>DD</sub>	V <sub>DD</sub> = 3.3V, per channel		4.5	8	mA	
		V <sub>DD</sub> = 5V, per channel		6.3	10		
Shutdown Current	I <sub>SHDN</sub>			0.1	10	μA	
Common-Mode Rejection Ratio	CMRR	f <sub>IN</sub> = 1kHz		66		dB	
Input Bias Voltage	V <sub>BIAS</sub>		1.125	1.25	1.375	V	
Turn-On Time	t <sub>ON</sub>			40		ms	
Output Offset Voltage	V <sub>OS</sub>	T <sub>A</sub> = +25°C		±10	±30	mV	
		T <sub>MIN</sub> < T <sub>A</sub> < T <sub>MAX</sub>			±55		
Power-Supply Rejection Ratio	PSRR	V <sub>DD</sub> = 2.5V to 5.5V, V <sub>IN</sub> = 0V	60	80		dB	
		100mV <sub>P-P</sub> ripple, V <sub>IN</sub> = 0V	f <sub>RIPPLE</sub> = 217Hz		72		
			f <sub>RIPPLE</sub> = 20kHz		50		
Output Power (Note 3)	P <sub>OUT</sub>	THD+N = 1%, T <sub>A</sub> = +25°C	V <sub>DD</sub> = 3.3V	R <sub>L</sub> = 8Ω	460	mW	
				R <sub>L</sub> = 4Ω	750		
			V <sub>DD</sub> = 5V	R <sub>L</sub> = 8Ω	1300		
				R <sub>L</sub> = 4Ω	2200		
Total Harmonic Distortion Plus Noise (Note 3)	THD+N	R <sub>L</sub> = 8Ω (P <sub>OUT</sub> = 300mW), f = 1kHz		0.08		%	
		R <sub>L</sub> = 4Ω (P <sub>OUT</sub> = 400mW), f = 1kHz		0.15			
Signal-to-Noise Ratio	SNR	V <sub>OUT</sub> = 1V <sub>RMS</sub>	BW = 22Hz to 22kHz	FFM	86	dB	
				SSM	86		
			A-weighted	FFM	88.5		
				SSM	88.5		
Oscillator Frequency	f <sub>OSC</sub>	SYNC = GND	950	1100	1250	kHz	
		SYNC = unconnected	1200	1400	1600		
		SYNC = V <sub>DD</sub>		1200	±60		
Minimum On-Time	t <sub>MIN</sub>			200		ns	
SYNC Frequency Lock Range	f <sub>SYNC</sub>		1000		1600	kHz	

# 1.3W, Filterless, Stereo Class D Audio Power Amplifier

MAX9701

## ELECTRICAL CHARACTERISTICS (continued)

( $V_{DD} = PV_{DD} = \overline{SHDN} = 3.3V$ ,  $GND = PGND = 0V$ ,  $SYNC = 0V$  (FFM), gain = 6dB (GAIN1 = 0, GAIN2 = 1),  $R_L$  connected between OUT+ and OUT-,  $R_L = \infty$ ,  $T_A = T_{MIN}$  to  $T_{MAX}$ , unless otherwise noted. Typical values are at  $T_A = +25^\circ C$ .) (Notes 1, 2)

PARAMETER	SYMBOL	CONDITIONS	MIN	TYP	MAX	UNITS
SYNC_OUT Capacitance Drive	$C_{SYNC\_OUT}$			100		pF
Capacitive Drive	$C_L$	Bridge-tied capacitance		200		pF
		Single ended		400		
Click-and-Pop Level	$K_{CP}$	Peak reading, THD+N = 1% A-weighted, 32 samples per second (Note 4)	Into shutdown		66.16	dB
			Out of shutdown		66.26	
Efficiency	$\eta$	$V_{DD} = 3.3V$ , $P_{OUT} = 500mW$ per channel, $f_{IN} = 1kHz$ , $R_L = 8\Omega$		87		%
		$V_{DD} = 5V$ , $P_{OUT} = 1000mW$ per channel, $f_{IN} = 1kHz$ , $R_L = 8\Omega$		87.4		
Input Resistance	$R_{IN}$	GAIN1 = 0, GAIN2 = 0	10.5	15	19.5	k $\Omega$
		GAIN1 = 1, GAIN2 = 0		25		
		GAIN1 = 0, GAIN2 = 1		37.4		
		GAIN1 = 1, GAIN2 = 1		50		
Gain	$A_V$	GAIN1 = 0, GAIN2 = 0		18		dB
		GAIN1 = 1, GAIN2 = 0		12		
		GAIN1 = 0, GAIN2 = 1		6		
		GAIN1 = 1, GAIN2 = 1		0		
Channel-to-Channel Gain Tracking			1		%	
Crosstalk		L to R, R to L, $f = 10kHz$ , $R_L = 8\Omega$ , $P_{OUT} = 300mW$		70		dB
<b>DIGITAL INPUTS (<math>\overline{SHDN}</math>, SYNC, GAIN1, GAIN2)</b>						
Input-Voltage High	$V_{INH}$		2			V
Input-Voltage Low	$V_{INL}$				0.8	V
Input Leakage Current ( $\overline{SHDN}$ , GAIN1, GAIN2)					$\pm 1$	$\mu A$
Input Leakage Current (SYNC)		$V_{IN} = GND$ , normal operation	-15	-7		$\mu A$
		$V_{IN} = V_{DD}$ , normal operation		12	25	
<b>DIGITAL OUTPUTS (SYNC_OUT)</b>						
Output-Voltage High	$V_{OH}$	$I_{OH} = 3mA$ , $V_{DD} = 3.3V$	2.4			V
Output-Voltage Low	$V_{OL}$	$I_{OL} = 3mA$		0.08		V

**Note 1:** All devices are 100% production tested at +25°C. All temperature limits are guaranteed by design.

**Note 2:** Testing performed with a resistive load in series with an inductor to simulate an actual speaker load. For  $R_L = 4\Omega$ ,  $L = 33\mu H$ . For  $R_L = 8\Omega$ ,  $L = 68\mu H$ .

**Note 3:** When driving speakers below 4 $\Omega$  with large signals, exercise care to avoid violating the absolute maximum rating for continuous output current.

**Note 4:** Testing performed with 8 $\Omega$  resistive load in series with 68 $\mu H$  inductive load connected across the BTL output. Mode transitions are controlled by  $\overline{SHDN}$ .  $K_{CP}$  level is calculated as:  $20 \times \log[(\text{peak voltage under normal operation at rated power level}) / (\text{peak voltage during mode transition, no input signal})]$ . Units are expressed in dB.

# 1.3W, Filterless, Stereo Class D Audio Power Amplifier

## Typical Operating Characteristics

( $V_{DD} = PV_{DD} = \overline{SHDN} = 3.3V$ ,  $GND = PGND = 0V$ ,  $SYNC = V_{DD}$  (SSM), gain = 6dB (GAIN1 = 0, GAIN2 = 1)).

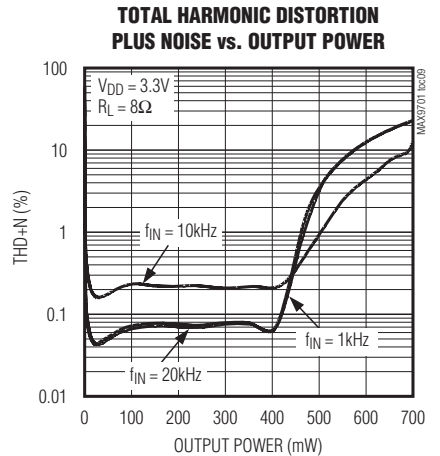
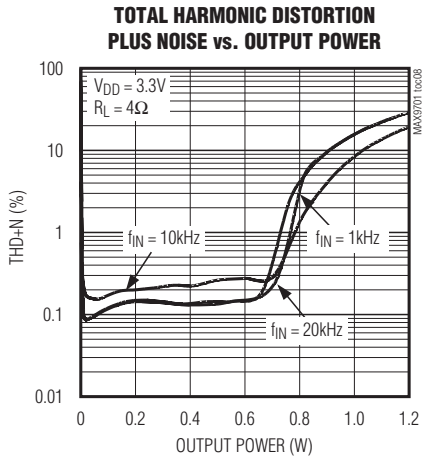
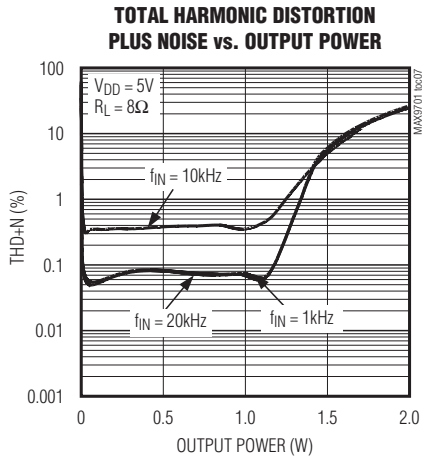
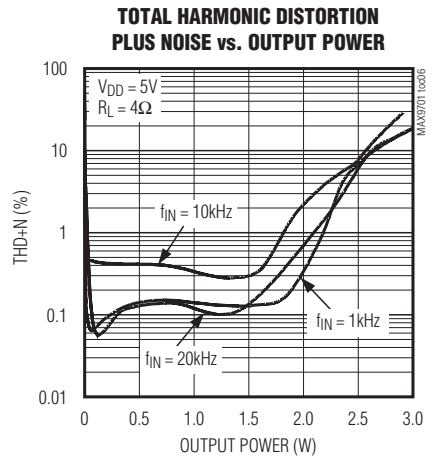
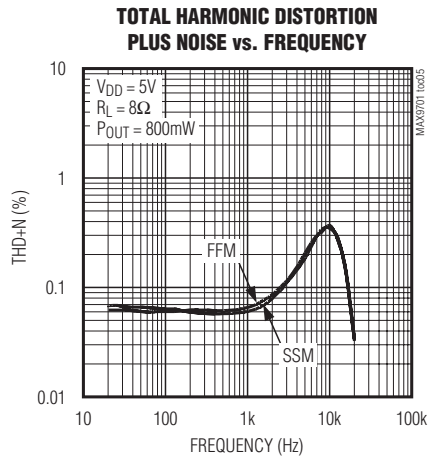
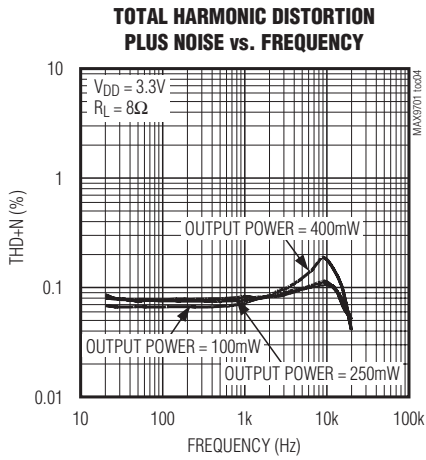
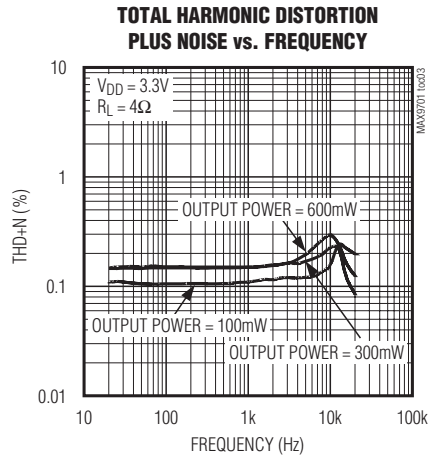
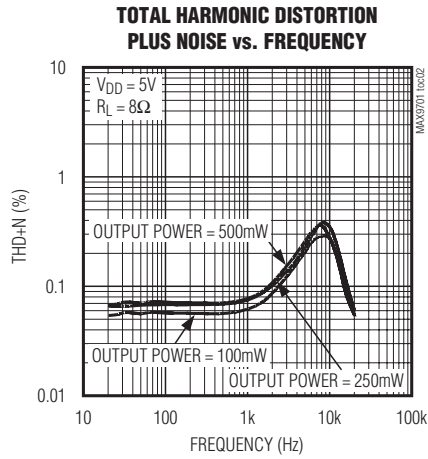
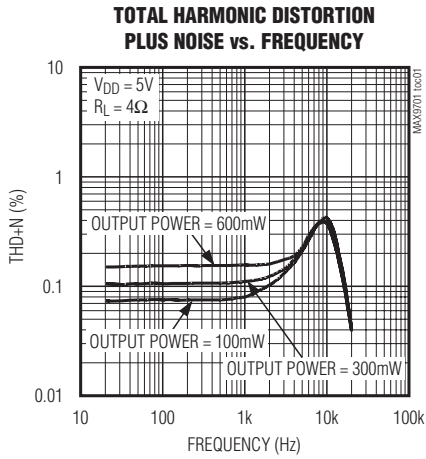

# 1.3W, Filterless, Stereo Class D Audio Power Amplifier

MAX9701

## Typical Operating Characteristics (continued)

( $V_{DD} = PV_{DD} = \overline{SHDN} = 3.3V$ ,  $GND = PGND = 0V$ ,  $SYNC = V_{DD}$  (SSM), gain = 6dB (GAIN1 = 0, GAIN2 = 1)).

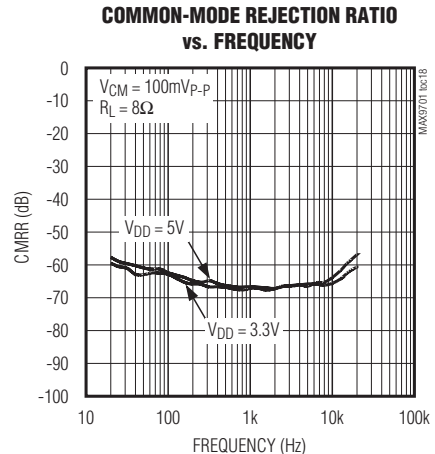
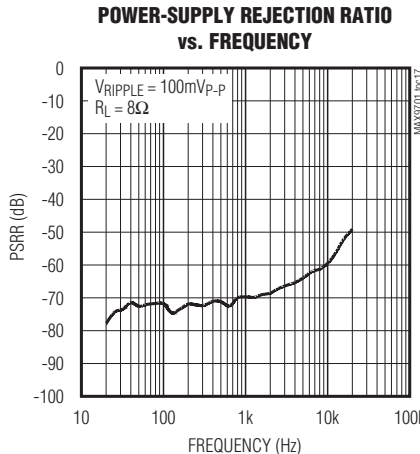
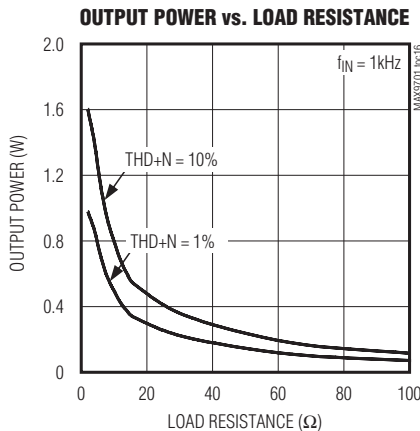
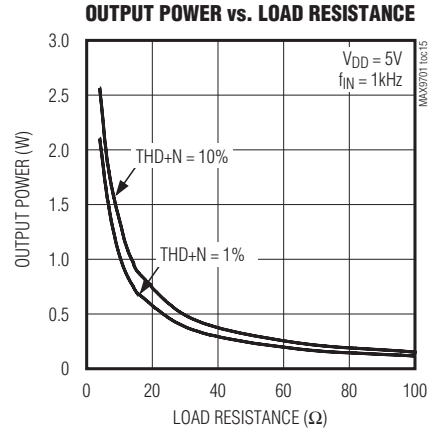
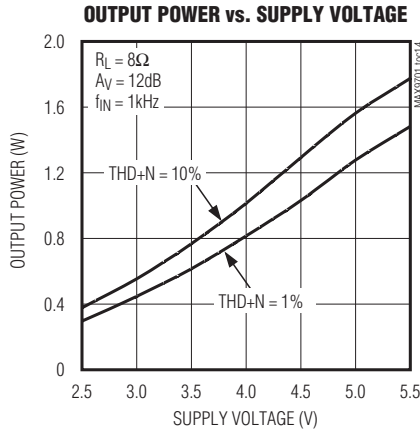
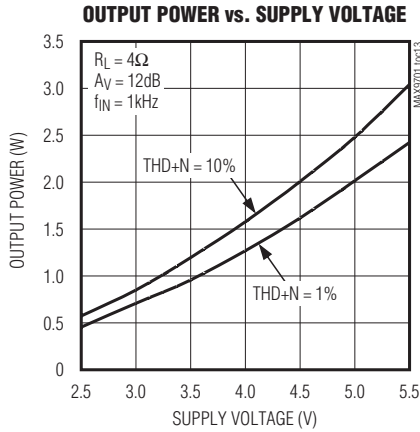
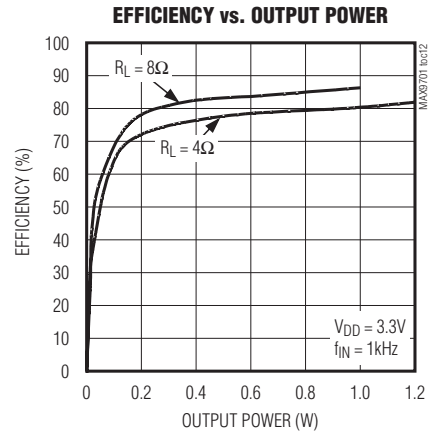
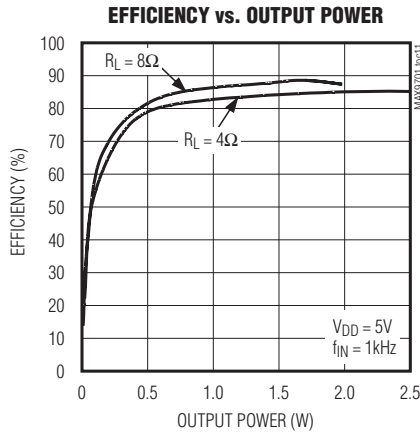
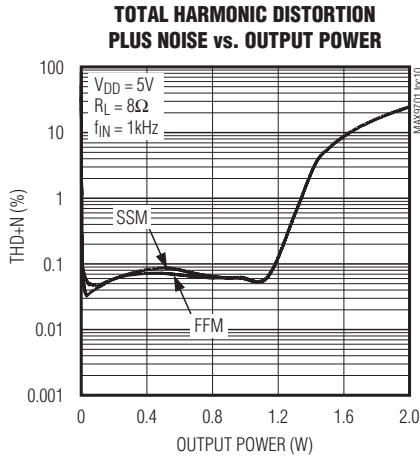

# 1.3W, Filterless, Stereo Class D Audio Power Amplifier

## Typical Operating Characteristics (continued)

( $V_{DD} = PV_{DD} = \overline{SHDN} = 3.3V$ ,  $GND = PGND = 0V$ ,  $SYNC = V_{DD}$  (SSM), gain = 6dB (GAIN1 = 0, GAIN2 = 1)).

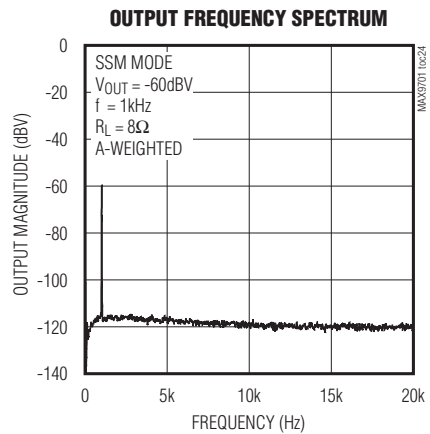
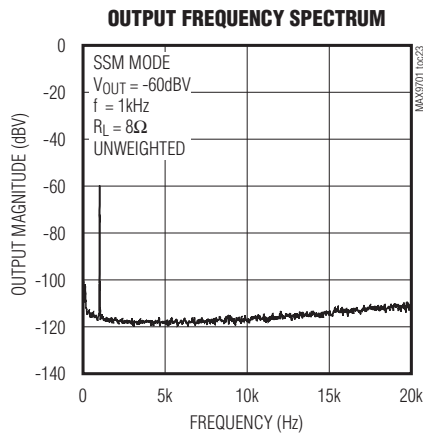
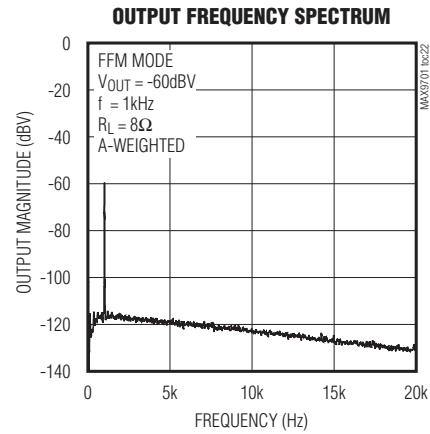
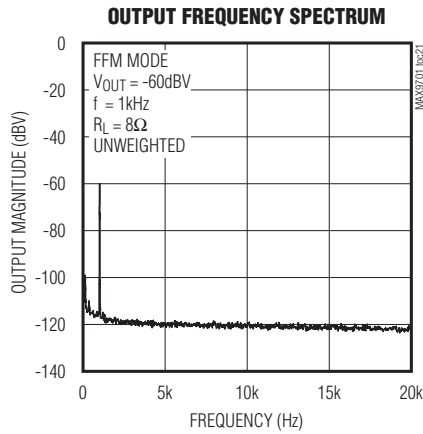
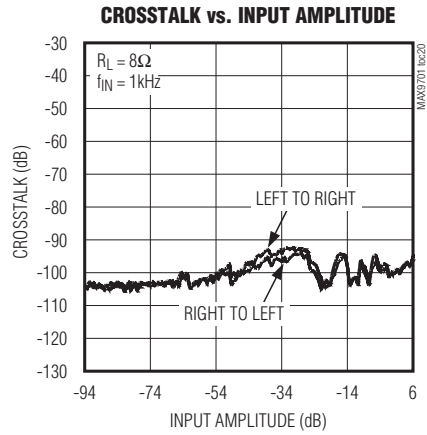
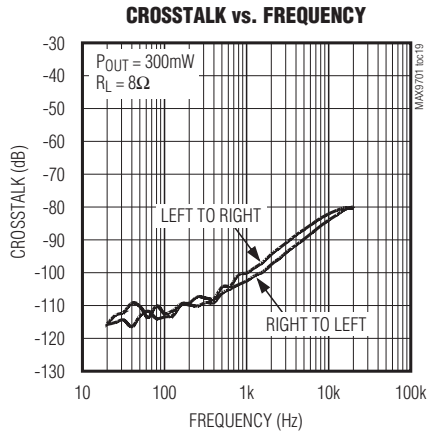

# 1.3W, Filterless, Stereo Class D Audio Power Amplifier

MAX9701

## Typical Operating Characteristics (continued)

( $V_{DD} = PV_{DD} = \overline{SHDN} = 3.3V$ ,  $GND = PGND = 0V$ ,  $SYNC = V_{DD}$  (SSM), gain = 6dB (GAIN1 = 0, GAIN2 = 1)).

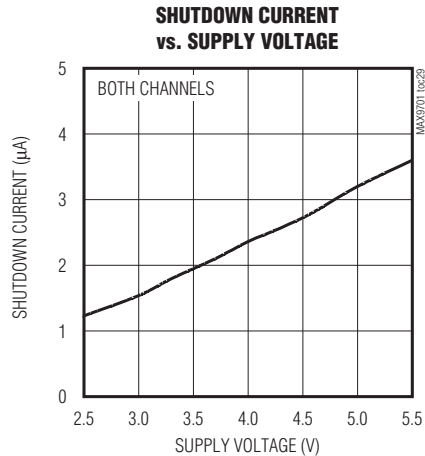
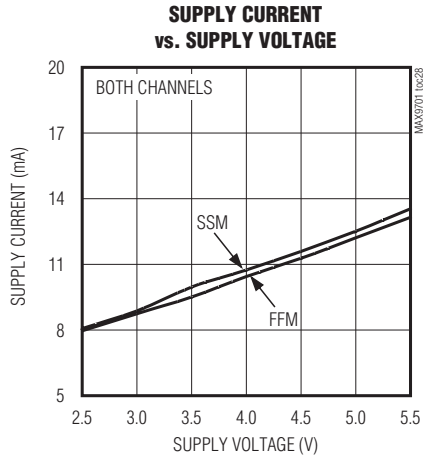
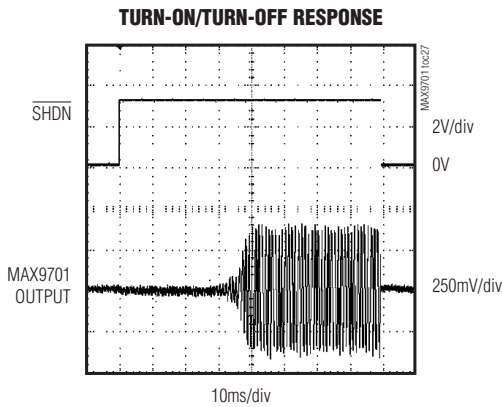
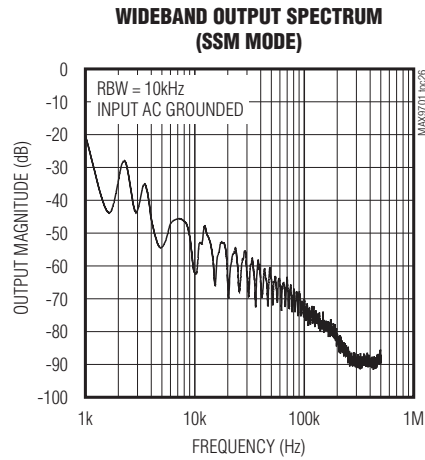
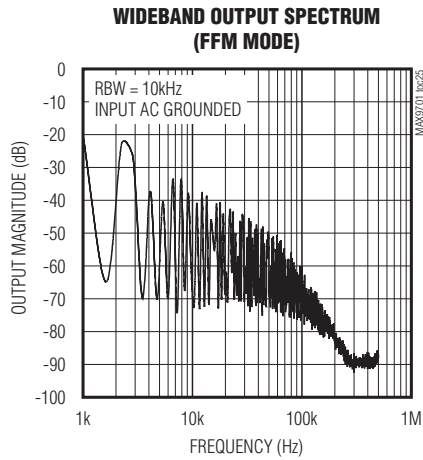

# 1.3W, Filterless, Stereo Class D Audio Power Amplifier

## Pin Description

PIN		NAME	FUNCTION
TQFN	UCSP		
1	A2	SHDN	Active-Low Shutdown. Connect to V <sub>DD</sub> for normal operation.
2	B3	SYNC	Frequency Select and External Clock Input. SYNC = GND: Fixed-frequency mode with f <sub>S</sub> = 1100kHz. SYNC = Unconnected: Fixed-frequency mode with f <sub>S</sub> = 1400kHz. SYNC = V <sub>DD</sub> : Spread-spectrum mode with f <sub>S</sub> = 1200kHz ±60kHz. SYNC = Clocked: Fixed-frequency mode with f <sub>S</sub> = external clock frequency.
3, 8, 11, 16	—	N.C.	No Connection. Not internally connected.
4	A3	OURL+	Left-Channel Amplifier Output Positive Phase
5, 14	A4, D4	PV <sub>DD</sub>	H-Bridge Power Supply. Connect to V <sub>DD</sub> . Bypass with a 0.1μF capacitor to PGND.
6, 13	B4, C4	PGND	Power Ground
7	A5	OURL-	Left-Channel Amplifier Output Negative Phase
9, 22	B1, B5	GND	Analog Ground
10	C5	SYNC_OUT	Clock Signal Output
12	D5	OUTR-	Right-Channel Amplifier Output Negative Phase
15	D3	OUTR+	Right-Channel Amplifier Output Positive Phase
17	C3	GAIN1	Gain-Select Input 1
18	D2	GAIN2	Gain-Select Input 2
19	D1	INR-	Right-Channel Inverting Input
20	C2	INR+	Right-Channel Noninverting Input
21	C1	V <sub>DD</sub>	Analog Power Supply. Connect to PV <sub>DD</sub> . Bypass with a 10μF capacitor to GND.
23	B2	INL+	Left-Channel Noninverting Input
24	A1	INL-	Left-Channel Inverting Input
EP	—	EP	Exposed Pad. Connect the exposed thermal pad to the GND plane (see the <i>Supply Bypassing, Layout, and Grounding</i> section).



# 1.3W, Filterless, Stereo Class D Audio Power Amplifier

## Functional Diagram

MAX9701

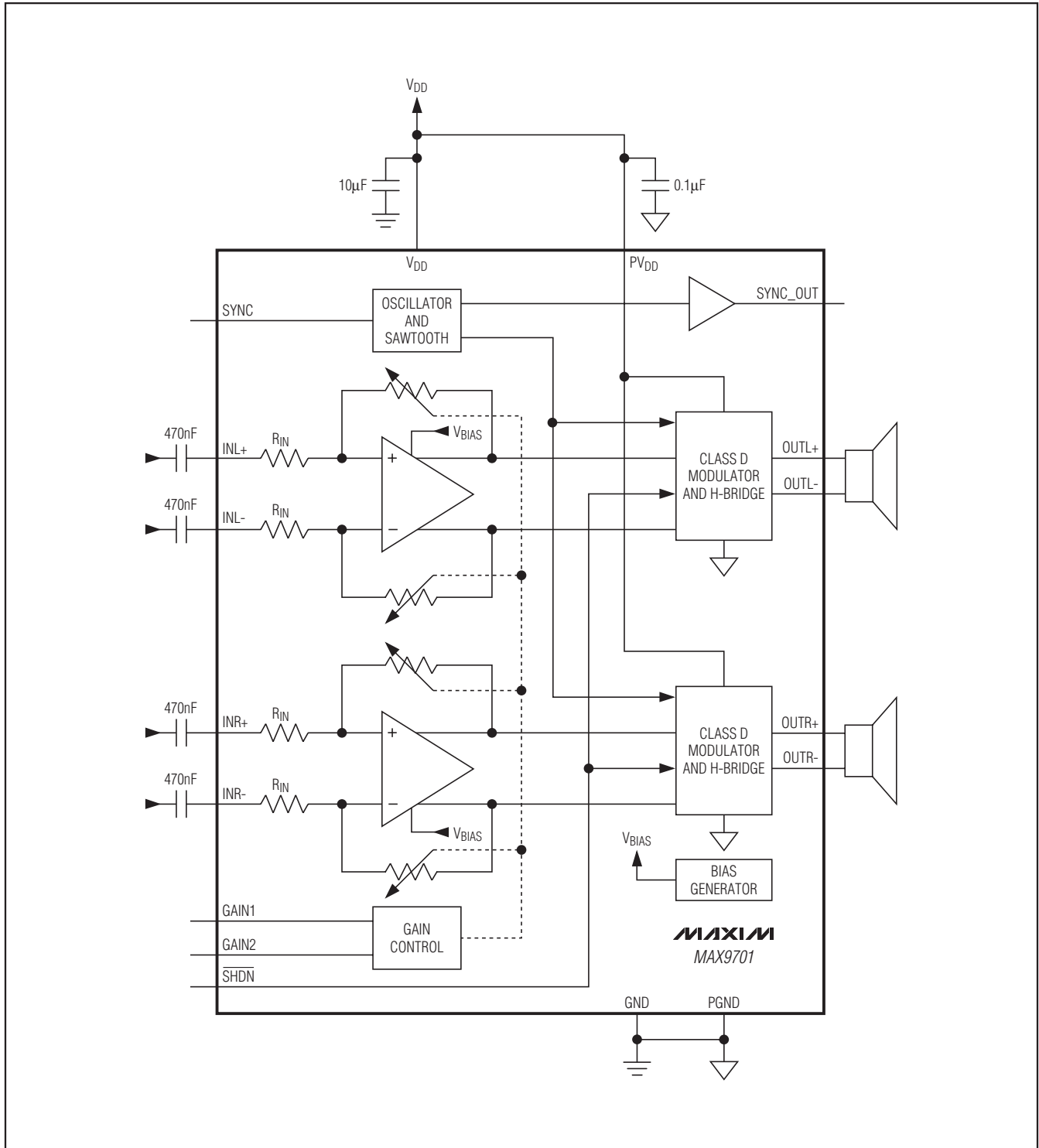

# 1.3W, Filterless, Stereo Class D Audio Power Amplifier

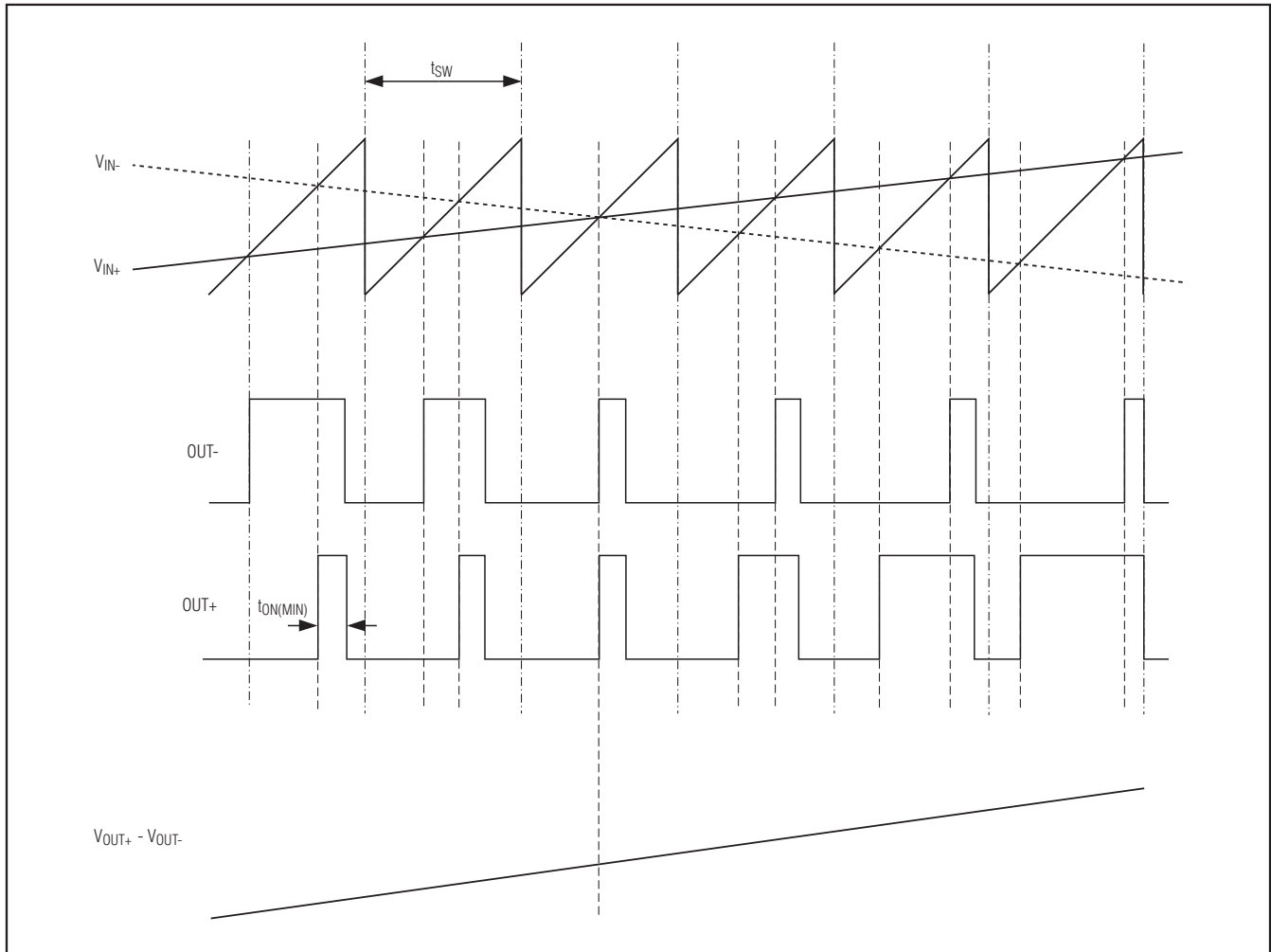

Figure 1. MAX9701 Outputs with an Input Signal Applied

## Detailed Description

The MAX9701 filterless, stereo Class D audio power amplifier features several improvements to switch-mode amplifier technology. The MAX9701 offers Class AB performance with Class D efficiency, while occupying minimal board space. A unique, filterless modulation scheme, synchronizable switching frequency, and spread-spectrum switching mode create a compact, flexible, low-noise, efficient audio power amplifier. The differential input architecture reduces common-mode noise pickup, and can be used without input-coupling capacitors. The inputs can also be configured to accept a single-ended input signal.

Comparators monitor the MAX9701 inputs and compare the complementary input voltages to the sawtooth waveform. The comparators trip when the input magnitude of the sawtooth exceeds their corresponding input voltage. Both comparators reset at a fixed time after the rising edge of the second comparator trip point, generating a minimum-width pulse ( $t_{ON(MIN)}$ ) at the output of the second comparator (Figure 1). As the input voltage increases or decreases, the duration of the pulse at one output increases while the other output pulse duration remains the same. This causes the net voltage across the speaker ( $V_{OUT+} - V_{OUT-}$ ) to change. The minimum-width pulse helps the device to achieve high levels of linearity.

# 1.3W, Filterless, Stereo Class D Audio Power Amplifier

MAX9701

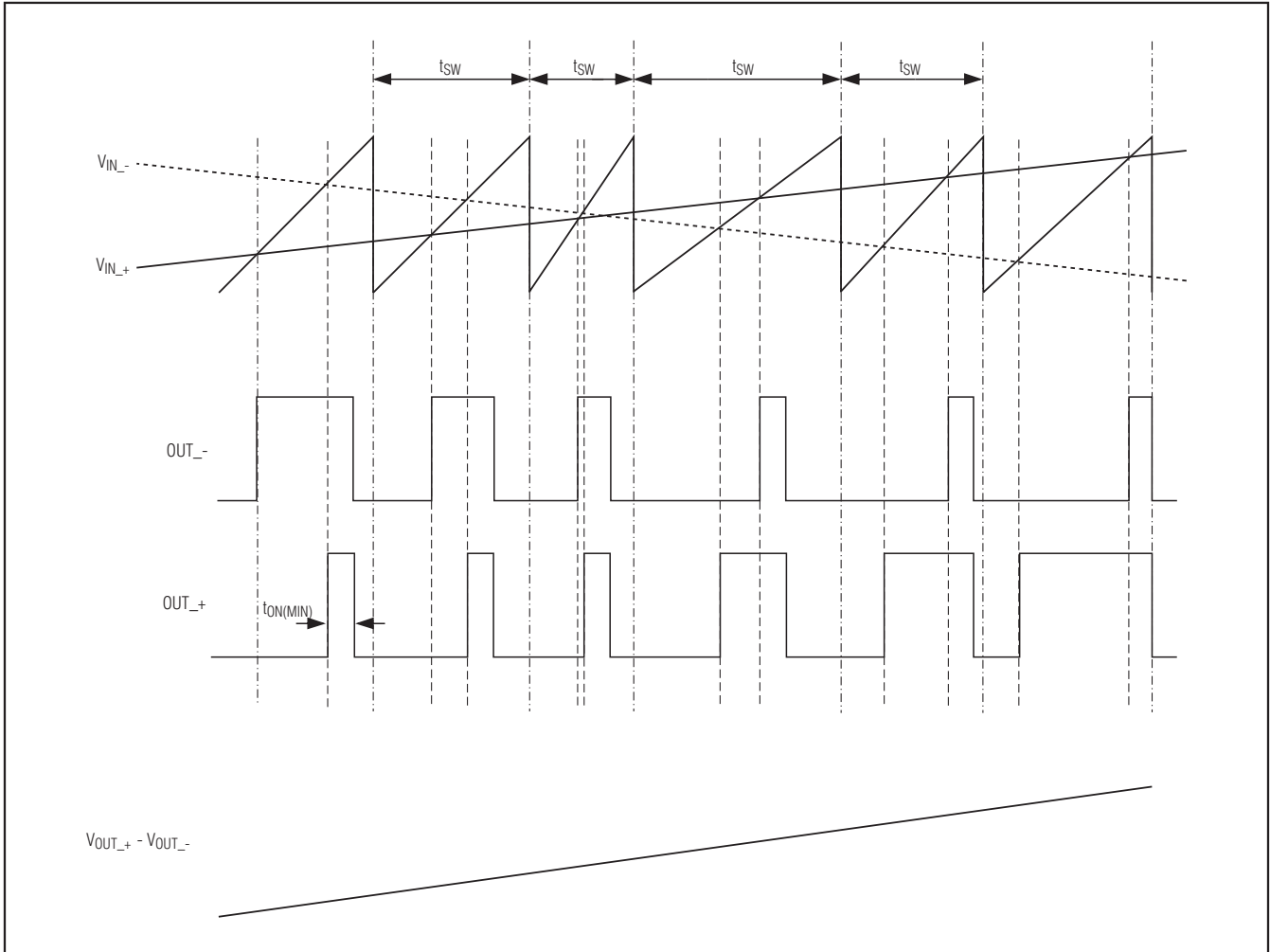

Figure 2. MAX9701 Outputs with an Input Signal Applied (SSM Mode)

## Operating Modes

### Fixed-Frequency (FFM) Mode

The MAX9701 features two fixed-frequency modes. Connect SYNC to GND to select a 1.1MHz switching frequency. Leave SYNC unconnected to select a 1.4MHz switching frequency. The frequency spectrum of the MAX9701 consists of the fundamental switching frequency and its associated harmonics (see the Wideband Output Spectrum (FFM Mode) graph in the *Typical Operating Characteristics*). Program the switching frequency so the harmonics do not fall within a sensitive frequency band (Table 1). Audio reproduction is not affected by changing the switching frequency.

Table 1. Operating Modes

SYNC	MODE
GND	FFM with $f_{osc} = 1100\text{kHz}$
Unconnected	FFM with $f_{osc} = 1400\text{kHz}$
V <sub>DD</sub>	SSM with $f_{osc} = 1200\text{kHz} \pm 60\text{kHz}$
Clocked	FFM with $f_{osc} = \text{external clock frequency}$

# 1.3W, Filterless, Stereo Class D Audio Power Amplifier

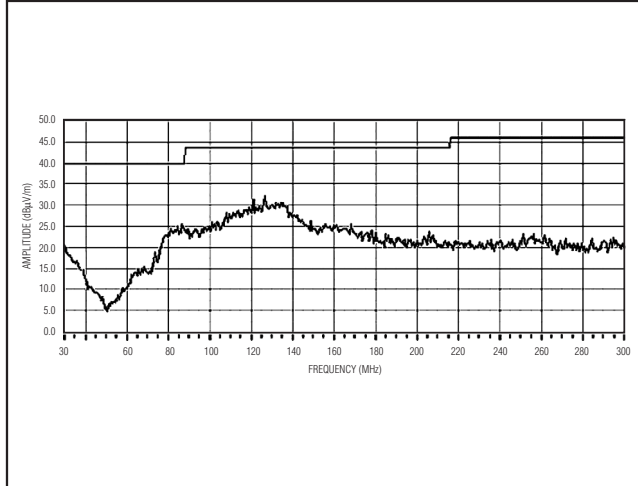

Figure 3. MAX9701 with 76mm of Speaker Cable with TDK Common-Mode Choke: TDK ACM4532-801-20-X

### Spread-Spectrum (SSM) Mode

The MAX9701 features a unique spread-spectrum mode that flattens the wideband spectral components, improving EMI emissions that may be radiated by the speaker and cables. This mode is enabled by setting  $SYNC = V_{DD}$  (Table 1). In SSM mode, the switching frequency varies randomly by  $\pm 60\text{kHz}$  around the center frequency (1.2MHz). The modulation scheme remains the same, but the period of the sawtooth waveform changes from cycle to cycle (Figure 2). Instead of a large amount of spectral energy present at multiples of the switching frequency, the energy is now spread over a bandwidth that increases with frequency. Above a few megahertz, the wideband spectrum looks like white noise for EMI purposes (Figure 3). A proprietary amplifier topology ensures this does not corrupt the noise floor in the audio bandwidth.

### Synchronous Switching Mode

#### SYNC

The SYNC input allows the MAX9701 to be synchronized to a user-defined clock, or another Maxim Class D amplifier, creating a fully synchronous system, minimizing clock intermodulation, and allocating spectral components of the switching harmonics to insensitive frequency bands. Applying a TTL clock signal between 1000kHz and 1600kHz to SYNC synchronizes the MAX9701. The period of the SYNC clock can be randomized, allowing the MAX9701 to be synchronized to another Maxim Class D amplifier operating in SSM mode.

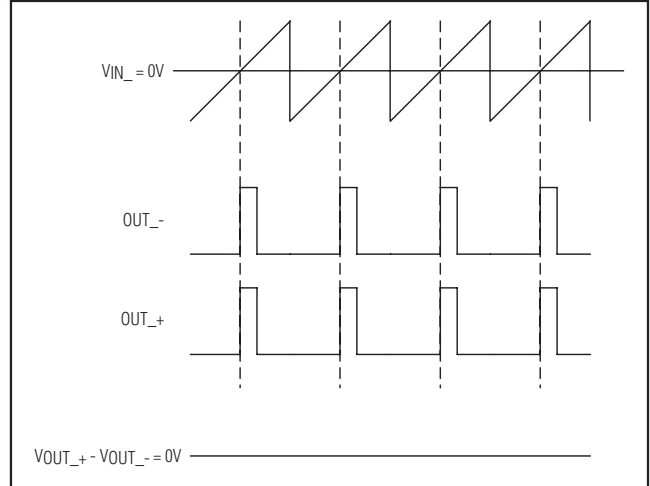

Figure 4. MAX9701 Outputs with No Input Signal

### SYNC\_OUT

SYNC\_OUT allows several MAX9701s as well as other Class D amplifiers (such as the MAX9700) to be cascaded. The synchronized output minimizes interference due to clock intermodulation caused by the switching spread between single devices. Using SYNC\_OUT, the modulation scheme remains the same and audio reproduction is not affected by changing the switching frequency.

### Filterless Modulation/Common-Mode Idle

The MAX9701 uses Maxim's unique modulation scheme that eliminates the LC filter required by traditional class D amplifiers, improving efficiency, reducing component count, conserving board space and system cost. Conventional Class D amplifiers output a 50% duty cycle, 180° out-of-phase square wave when no signal is present. With no filter, the square wave appears across the load as a DC voltage, resulting in finite load current, which increases power consumption especially when idling. When no signal is present at the input of the MAX9701, the amplifiers will output an in-phase square wave as shown in Figure 4. Because the MAX9701 drives the speaker differentially, the two outputs cancel each other, resulting in no net idle mode voltage across the speaker, minimizing power consumption.

### Efficiency

Efficiency of a Class D amplifier is due to the switching operation of the output stage transistors. In a Class D amplifier, the output transistors act as current-steering switches and consume negligible additional power. Any power loss associated with the Class D output stage is mostly due to the  $I^2R$  loss of the MOSFET on-resistance and quiescent-current overhead.

# 1.3W, Filterless, Stereo Class D Audio Power Amplifier

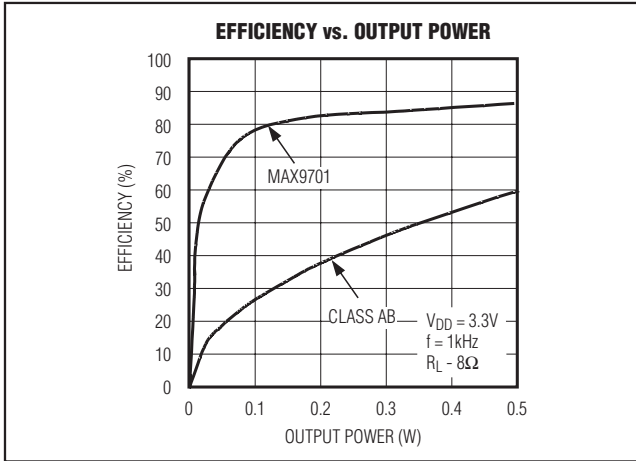

Figure 5. MAX9701 Efficiency vs. Class AB Efficiency

The theoretical best efficiency of a linear amplifier is 78%; however, that efficiency is only exhibited at peak output powers. Under normal operating levels (typical music reproduction levels), efficiency falls below 30%, whereas the MAX9701 still exhibits >80% efficiencies under the same conditions (Figure 5).

### Shutdown

The MAX9701 has a shutdown mode that reduces power consumption and extends battery life. Driving  $\overline{SHDN}$  low places the MAX9701 in a low-power (0.1 $\mu$ A) shutdown mode. Connect  $\overline{SHDN}$  to  $V_{DD}$  for normal operation.

### Click-and-Pop Suppression

The MAX9701 features comprehensive click-and-pop suppression that eliminates audible transients on startup and shutdown. While in shutdown, the H-bridge is in a high-impedance state. During startup, or power-up, the input amplifiers are muted and an internal loop sets the modulator bias voltages to the correct levels, preventing clicks and pops when the H-bridge is subsequently enabled. For 40ms following startup, a soft-start function gradually unmutes the input amplifiers.

## Applications Information

### Filterless Operation

Traditional Class D amplifiers require an output filter to recover the audio signal from the amplifier's PWM output. The filters add cost, increase the solution size of the amplifier, and can decrease efficiency. The traditional PWM scheme uses large differential output swings ( $2 \times V_{DD(P-P)}$ ) and causes large ripple currents. Any parasitic resistance in the filter components results in a loss of power, lowering the efficiency.

The MAX9701 does not require an output filter. The device relies on the inherent inductance of the speaker coil and the natural filtering of both the speaker and the human ear to recover the audio component of the square-wave output. Eliminating the output filter results in a smaller, less costly, more efficient solution.

Because the frequency of the MAX9701 output is well beyond the bandwidth of most speakers, voice coil movement due to the square-wave frequency is very small. Although this movement is small, a speaker not designed to handle the additional power can be damaged. For optimum results, use a speaker with a series inductance >10 $\mu$ H. Typical 8 $\Omega$  speakers, for portable audio applications, exhibit series inductances in the range of 20 $\mu$ H to 100 $\mu$ H.

### Output Offset

Unlike a Class AB amplifier, the output offset voltage of a Class D amplifier does not noticeably increase quiescent current draw when a load is applied. This is due to the power conversion of the Class D amplifier. For example, an 8mV DC offset across an 8 $\Omega$  load results in 1mA extra current consumption in a Class AB device. In the Class D case, an 8mV offset into 8 $\Omega$  equates to an additional power drain of 8 $\mu$ W. Due to the high efficiency of the Class D amplifier, this represents an additional quiescent current draw of:  $8\mu W / (V_{DD} / 100 \times \eta)$ , which is on the order of a few  $\mu$ A.

### Selectable Gain

The MAX9701 features four selectable gain settings, minimizing external component count. Gains of 0dB, 3dB, 12dB, and 18dB are set through gain-select inputs, GAIN1 and GAIN2. GAIN1 and GAIN2 can be hard-wired or digitally controlled. Table 2 shows the suggested gain settings to attain a maximum output power from a given peak input voltage and given load at  $V_{DD} = 3.3V$  and THD+N = 10%.

Table 2. Gain Settings

GAIN1	GAIN2	GAIN (dB)	INPUT (V <sub>RMS</sub> )	R <sub>L</sub> ( $\Omega$ )	P <sub>OUT</sub> (mW)
0	0	+18	0.305	4	1100
1	0	+12	0.615	4	1100
0	1	+6	1.213	4	1100
1	1	0	2.105	4	1100
0	0	+18	0.345	8	725
1	0	+12	0.686	8	725
0	1	+6	1.360	8	725
1	1	0	2.705	8	725

# 1.3W, Filterless, Stereo Class D Audio Power Amplifier

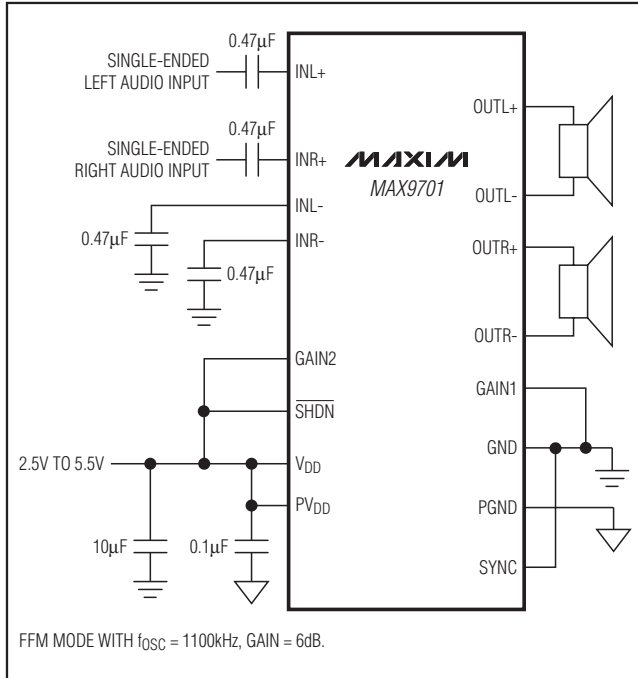

Figure 6. Single-Ended Input

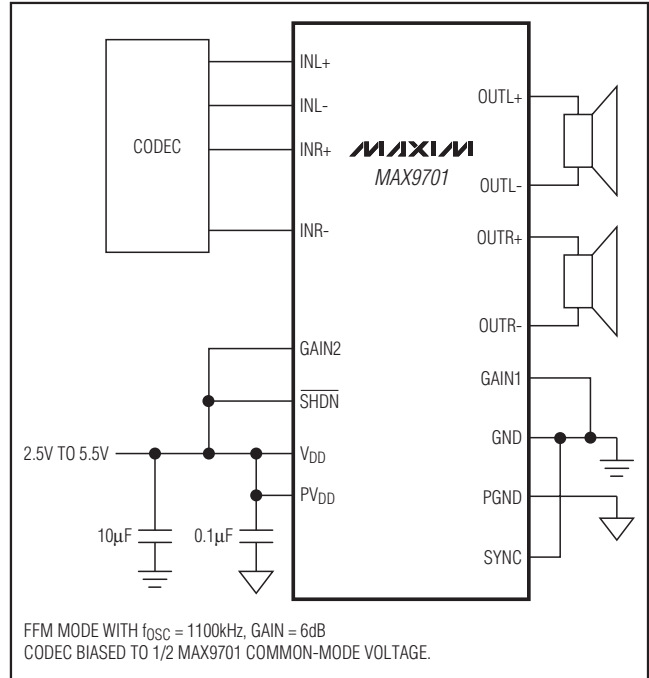

Figure 7. DC-Coupled Inputs

## Input Amplifier

### Differential Input

The MAX9701 features a differential input structure, making it compatible with many CODECs and offers improved noise immunity over a single-ended input amplifier. In devices such as cellular phones, high-frequency signals from the RF transmitter can be picked up by the amplifier's input traces. The signals appear at the amplifier's inputs as common-mode noise. A differential input amplifier amplifies the difference of the two inputs, any signal common to both inputs is canceled.

### Single-Ended Input

The MAX9701 can be configured as a single-ended input amplifier by capacitively coupling either input to GND, and driving the other input (Figure 6).

### DC-Coupled Inputs

The input amplifier can accept DC-coupled inputs that are biased within the amplifier's common-mode range (see the *Typical Operating Characteristics*). DC coupling eliminates the input-coupling capacitors, reducing component count to potentially two external components (Figure 7). However, the highpass filtering effect of the capacitors is lost, allowing low-frequency signals to feed through to the load.

## Component Selection

### Input Filter

An input capacitor,  $C_{IN}$ , in conjunction with the MAX9701 input impedance ( $R_{IN}$ ) forms a highpass filter that removes the DC bias from an incoming signal. The AC-coupling capacitor allows the amplifier to automatically bias the signal to an optimum DC level. Assuming zero-source impedance, the -3dB point of the highpass filter is given by:

$$f_{-3\text{dB}} = \frac{1}{2\pi R_{IN} C_{IN}}$$

Choose  $C_{IN}$  so  $f_{-3\text{dB}}$  is well below the lowest frequency of interest. Use capacitors whose dielectrics have low-voltage coefficients, such as tantalum or aluminum electrolytic. Capacitors with high-voltage coefficients, such as ceramics, may result in increased distortion at low frequencies.

Other considerations when designing the input filter include the constraints of the overall system and the actual frequency band of interest. Although high-fidelity audio calls for a flat-gain response between 20Hz and 20kHz, portable voice-reproduction devices such as cellular phones and two-way radios need only concentrate on the frequency range of the spoken human voice (typically 300Hz to 3.5kHz). In addition, speakers used

# 1.3W, Filterless, Stereo Class D Audio Power Amplifier

MAX9701

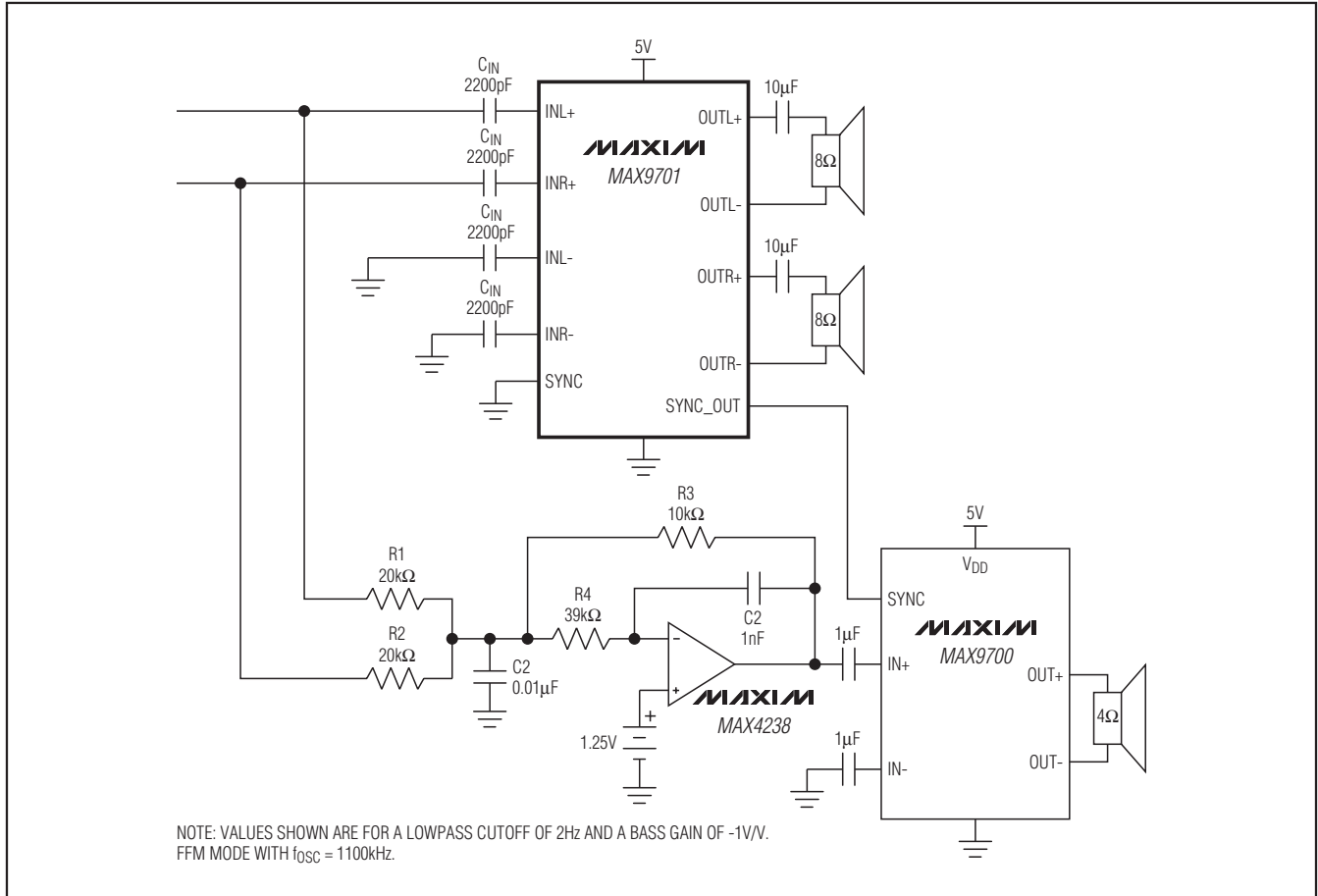

Figure 8. 2.1 Channel Application Circuit

in portable devices typically have a poor response below 300Hz. Taking these two factors into consideration, the input filter may not need to be designed for a 20Hz to 20kHz response, saving both board space and cost due to the use of smaller capacitors.

### Output Filter

The MAX9701 does not require an output filter. The device passes FCC emissions standards with 76mm of unshielded speaker cables. However, output filtering can be used if a design is failing radiated emissions due to board layout or cable length, or if the circuit is near EMI-sensitive devices. Use a ferrite bead filter when radiated frequencies above 10MHz are of concern. Use an LC filter or a common-mode choke when radiated emissions below 10MHz are of concern, or when long leads (>76mm) connect the amplifier to the speaker.

### 2.1 Channel Configuration

The typical 2.1 channel application circuit (Figure 8) shows the MAX9701 configured as a mid-/high-frequency amplifier and the MAX9700 configured as a mono bass amplifier. Input capacitors ( $C_{IN}$ ) set the highpass cutoff frequency according to the following equation:

$$f = \frac{1}{2\pi \times R_{IN} \times C_{IN}}$$

where  $R_{IN}$  is the typical input resistance of the MAX9701. The 10μF capacitors on the output of the MAX9701 ensure a two-pole highpass filter.

## 1.3W, Filterless, Stereo Class D Audio Power Amplifier

Low frequencies are summed through a two-pole low-pass filter and sent to the MAX9700 mono speaker amplifier. The passband gain of the lowpass filter is unity for in-phase stereo signals,

$$\frac{-2 \times R_3}{R_1}$$

where  $R_1 = R_2$  and  $R_3 = R_1 // R_2$ . The cutoff frequency of the lowpass filter is set by the following equation:

$$f = \frac{1}{2\pi} \times \sqrt{\frac{1}{C_1 \times C_2 \times R_3 \times R_4}}$$

### Supply Bypassing, Layout, and Grounding

Proper layout and grounding are essential for optimum performance. Use large traces for the power-supply inputs and amplifier outputs to minimize losses due to parasitic trace resistance. Large traces also aid in moving heat away from the package. Proper grounding improves audio performance, minimizes crosstalk between channels, and prevents any switching noise from coupling into the audio signal. Connect PGND and GND together at a single point on the PC board. Route all traces that carry switching transients away from GND and the traces/components in the audio signal path.

Bypass  $V_{DD}$  with  $10\mu\text{F}$  to GND and  $PV_{DD}$  with  $0.1\mu\text{F}$  to PGND. Place the bypass capacitors as close to the MAX9701 as possible. Use large, low-resistance output traces. Current drawn from the outputs increases as load impedance decreases. High-output trace resistance decreases the power delivered to the load. Large output, supply, and GND traces allow more heat to move from the MAX9701 to the air, decreasing the thermal impedance of the circuit.

The MAX9701 thin QFN-EP package features an exposed thermal pad on its underside. This pad lowers the package's thermal impedance by providing a direct heat conduction path from the die to the printed circuit board. Connect the exposed thermal pad to the GND plane.

### UCSP Applications Information

For the latest application details on UCSP construction, dimensions, tape carrier information, printed circuit board techniques, bump-pad layout, and recommended reflow temperature profile as well as the latest information on reliability testing results, refer to Application Note: *UCSP—A Wafer-Level Chip-Scale Package* available on Maxim's website at [www.maxim-ic.com/ucsp](http://www.maxim-ic.com/ucsp).



# 1.3W, Filterless, Stereo Class D Audio Power Amplifier

## System Diagram

MAX9701

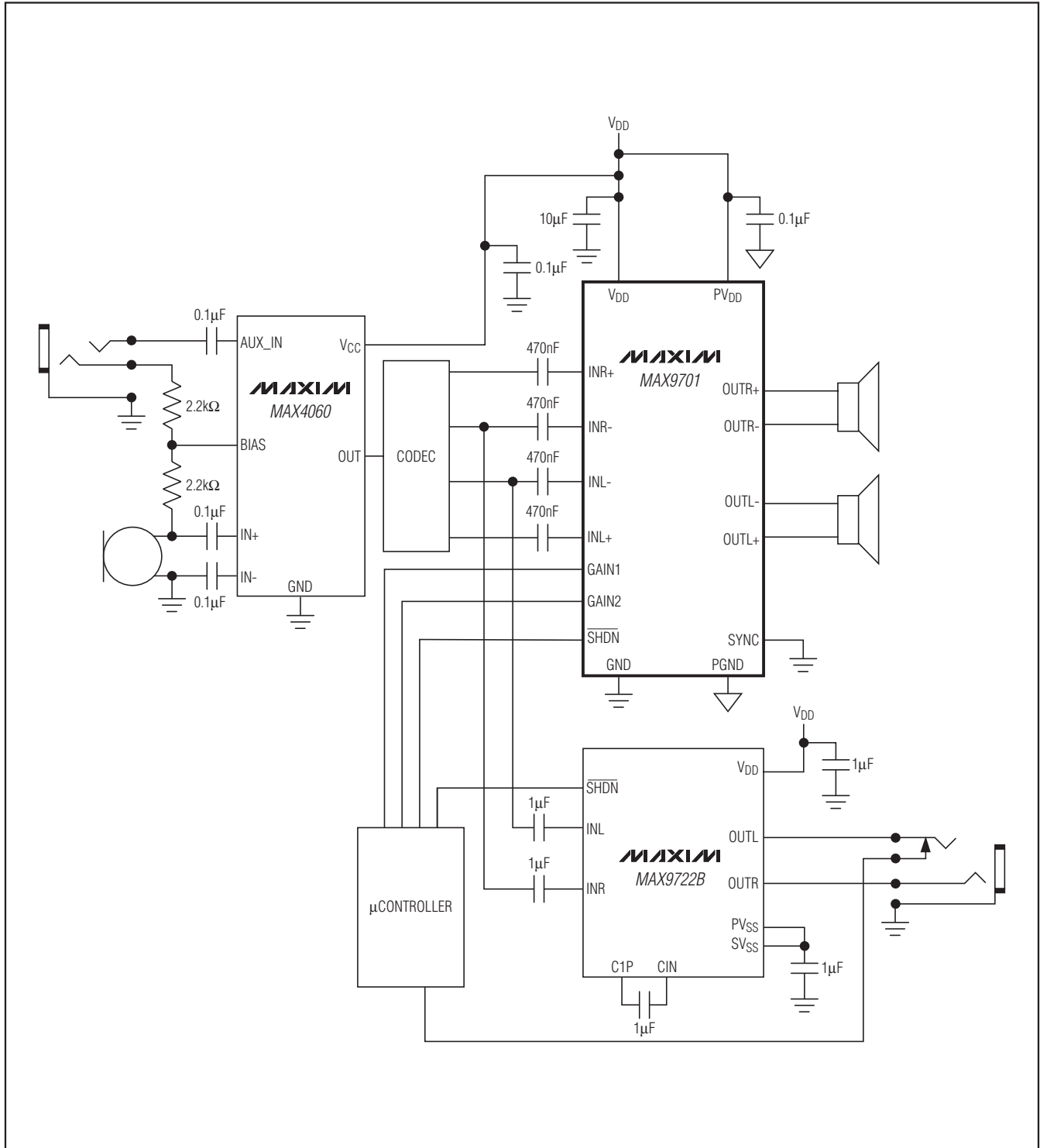

# 1.3W, Filterless, Stereo Class D Audio Power Amplifier

## Pin Configurations

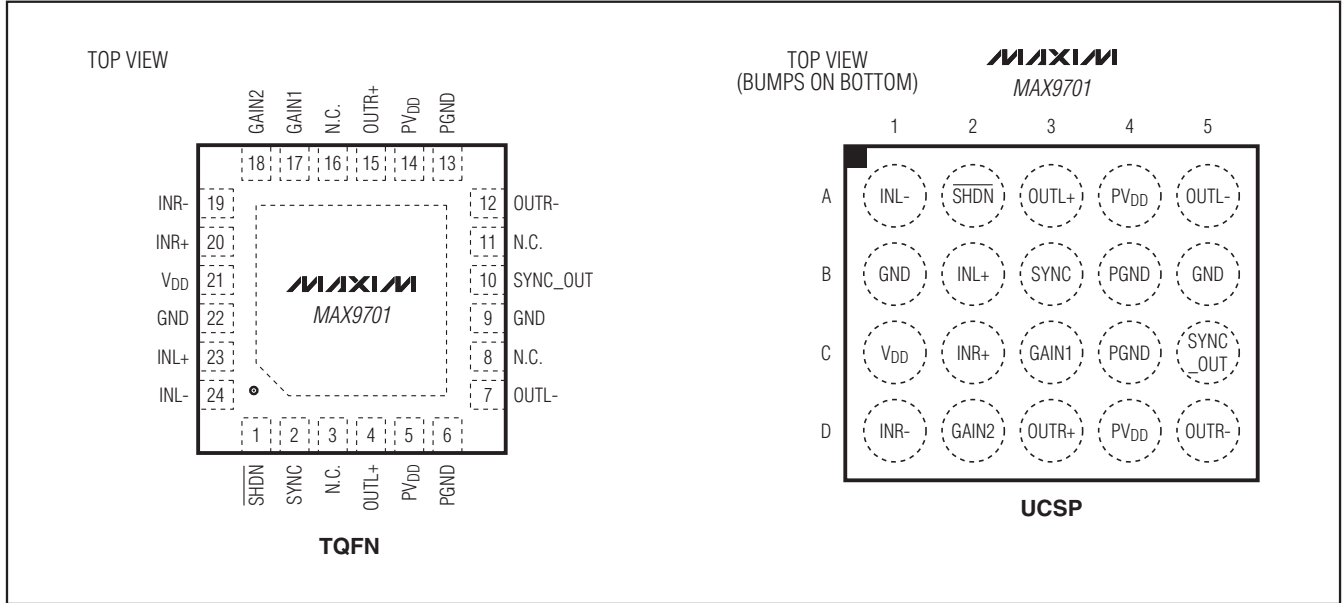

## Chip Information

TRANSISTOR COUNT: 5688

PROCESS: BiCMOS

# 1.3W, Filterless, Stereo Class D Audio Power Amplifier

## Package Information

For the latest package outline information and land patterns, go to [www.maxim-ic.com/packages](http://www.maxim-ic.com/packages). Note that a "+", "#", or "-" in the package code indicates RoHS status only. Package drawings may show a different suffix character, but the drawing pertains to the package regardless of RoHS status.

PACKAGE TYPE	PACKAGE CODE	DOCUMENT NO.
24 TQFN-EP	T2444-4	<a href="#">21-0139</a>
20 UCSP	B20-1	<a href="#">21-0095</a>

MAX9701

24L QFN THIN.EPS

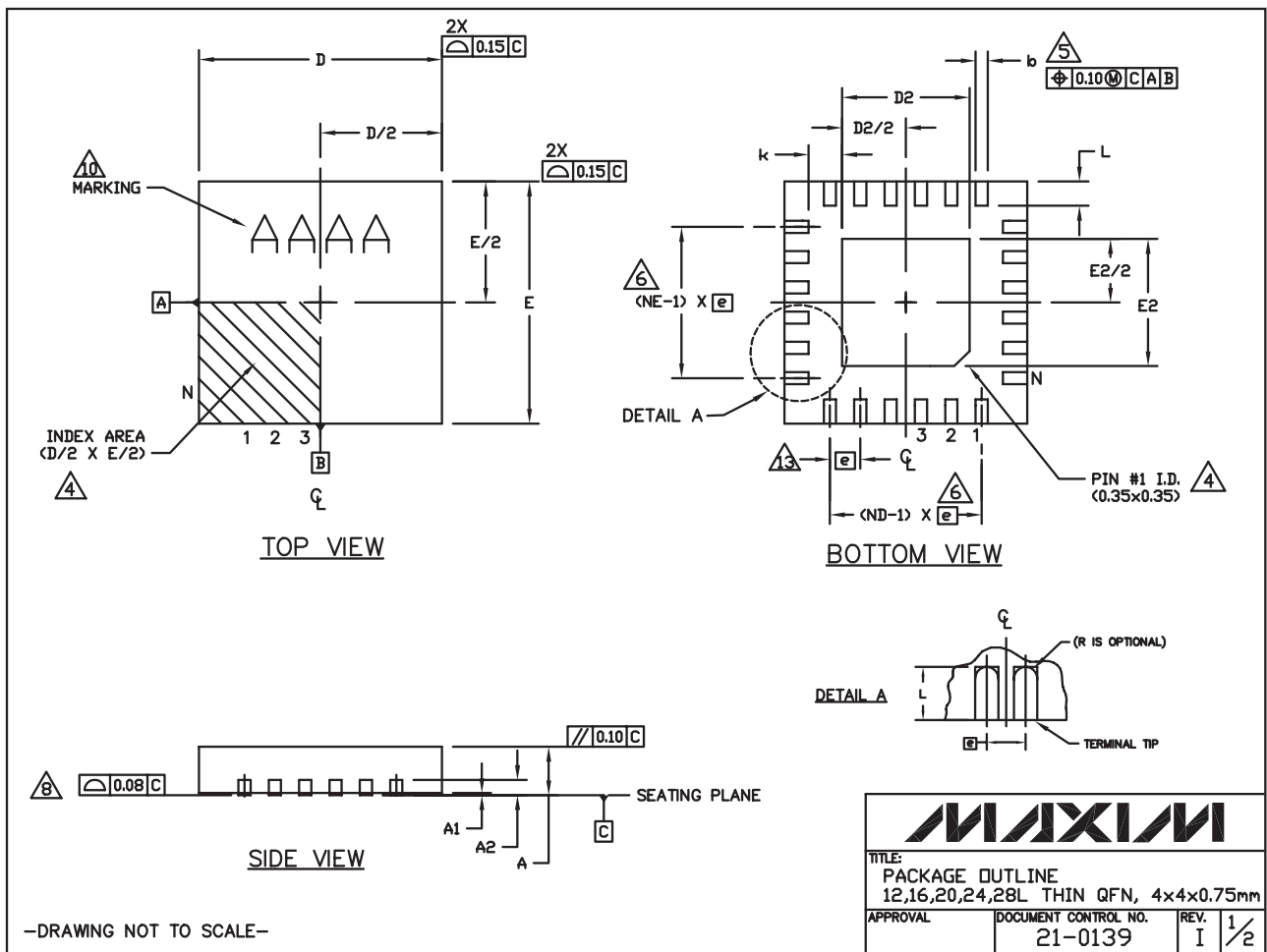

# 1.3W, Filterless, Stereo Class D Audio Power Amplifier

## Package Information (continued)

For the latest package outline information and land patterns, go to [www.maxim-ic.com/packages](http://www.maxim-ic.com/packages). Note that a "+", "#", or "-" in the package code indicates RoHS status only. Package drawings may show a different suffix character, but the drawing pertains to the package regardless of RoHS status.

COMMON DIMENSIONS															
PKG	12L 4x4			16L 4x4			20L 4x4			24L 4x4			28L 4x4		
REF.	MIN.	NDM.	MAX.	MIN.	NDM.	MAX.	MIN.	NDM.	MAX.	MIN.	NDM.	MAX.	MIN.	NDM.	MAX.
A	0.70	0.75	0.80	0.70	0.75	0.80	0.70	0.75	0.80	0.70	0.75	0.80	0.70	0.75	0.80
A1	0.0	0.02	0.05	0.0	0.02	0.05	0.0	0.02	0.05	0.0	0.02	0.05	0.0	0.02	0.05
A2	0.20 REF			0.20 REF			0.20 REF			0.20 REF			0.20 REF		
b	0.25	0.30	0.35	0.25	0.30	0.35	0.20	0.25	0.30	0.18	0.23	0.30	0.15	0.20	0.25
D	3.90	4.00	4.10	3.90	4.00	4.10	3.90	4.00	4.10	3.90	4.00	4.10	3.90	4.00	4.10
E	3.90	4.00	4.10	3.90	4.00	4.10	3.90	4.00	4.10	3.90	4.00	4.10	3.90	4.00	4.10
e	0.80 BSC.			0.65 BSC.			0.50 BSC.			0.50 BSC.			0.40 BSC.		
k	0.25	-	-	0.25	-	-	0.25	-	-	0.25	-	-	0.25	-	-
L	0.45	0.55	0.65	0.45	0.55	0.65	0.45	0.55	0.65	0.30	0.40	0.50	0.30	0.40	0.50
N	12			16			20			24			28		
ND	3			4			5			6			7		
NE	3			4			5			6			7		
Jedec Vpr.	VGGB			VGGC			VGGD-1			VGGD-2			VGGE		

EXPOSED PAD VARIATIONS						
PKG. CODES	D2			E2		
	MIN.	NDM.	MAX.	MIN.	NDM.	MAX.
T1244-3	1.95	2.10	2.25	1.95	2.10	2.25
T1244-4	1.95	2.10	2.25	1.95	2.10	2.25
T1644-3	1.95	2.10	2.25	1.95	2.10	2.25
T1644-4	1.95	2.10	2.25	1.95	2.10	2.25
T2044-2	1.95	2.10	2.25	1.95	2.10	2.25
T2044-3	1.95	2.10	2.25	1.95	2.10	2.25
T2444-2	1.95	2.10	2.25	1.95	2.10	2.25
T2444-3	2.45	2.60	2.63	2.45	2.60	2.63
T2444-4	2.45	2.60	2.63	2.45	2.60	2.63
T2444M-4	2.45	2.60	2.63	2.45	2.60	2.63
T2444M-1	2.45	2.60	2.63	2.45	2.60	2.63
T2844-1	2.50	2.60	2.70	2.50	2.60	2.70

**NOTES:**

1. DIMENSIONING & TOLERANCING CONFORM TO ASME Y14.5M-1994.
2. ALL DIMENSIONS ARE IN MILLIMETERS. ANGLES ARE IN DEGREES.
3. N IS THE TOTAL NUMBER OF TERMINALS.
4. THE TERMINAL #1 IDENTIFIER AND TERMINAL NUMBERING CONVENTION SHALL CONFORM TO JESD 95-1 SPP-012. DETAILS OF TERMINAL #1 IDENTIFIER ARE OPTIONAL, BUT MUST BE LOCATED WITHIN THE ZONE INDICATED. THE TERMINAL #1 IDENTIFIER MAY BE EITHER A MOLD OR MARKED FEATURE.
5. DIMENSION b APPLIES TO METALLIZED TERMINAL AND IS MEASURED BETWEEN 0.25mm AND 0.30mm FROM TERMINAL TIP.
6. ND AND NE REFER TO THE NUMBER OF TERMINALS ON EACH D AND E SIDE RESPECTIVELY.
7. DEPOPULATION IS POSSIBLE IN A SYMMETRICAL FASHION.
8. COPLANARITY APPLIES TO THE EXPOSED HEAT SINK SLUG AS WELL AS THE TERMINALS.
9. DRAWING CONFORMS TO JEDEC MO220, EXCEPT FOR T2444-3, T2444-4 AND T2844-1.
10. MARKING IS FOR PACKAGE ORIENTATION REFERENCE ONLY.
11. COPLANARITY SHALL NOT EXCEED 0.08mm.
12. WARPAGE SHALL NOT EXCEED 0.10mm.
13. LEAD CENTERLINES TO BE AT TRUE POSITION AS DEFINED BY BASIC DIMENSION 'e', ±0.05.
14. NUMBER OF LEADS SHOWN ARE FOR REFERENCE ONLY.
15. ALL DIMENSIONS ARE THE SAME FOR LEADED (-) & PbfREE (+) PACKAGE CODES.

TITLE: PACKAGE OUTLINE 12,16,20,24,28L THIN QFN, 4x4x0.75mm		
APPROVAL	DOCUMENT CONTROL NO. 21-0139	REV. 1 <span style="float: right;">2/2</span>

-DRAWING NOT TO SCALE-

# 1.3W, Filterless, Stereo Class D Audio Power Amplifier

## Package Information (continued)

For the latest package outline information and land patterns, go to [www.maxim-ic.com/packages](http://www.maxim-ic.com/packages). Note that a "+", "#", or "-" in the package code indicates RoHS status only. Package drawings may show a different suffix character, but the drawing pertains to the package regardless of RoHS status.

MAX9701

5x4 UCSP:EPS

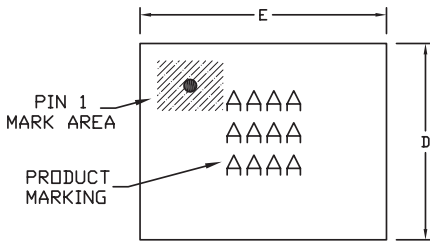

TOP VIEW

COMMON DIMENSIONS	
A	0.62±0.05-0.08
A1	0.29±0.02
A2	0.33 REF.
b	∅0.35±0.03
D1	1.50 BASIC
E1	2.00 BASIC
e	0.50 BASIC
SD	0.25 BASIC
SE	0.00 BASIC

PKG. CODE	VARIABLE DIMENSIONS		DEPOPULATED SOLDER BALLS
	D	E	
B20-1	2.03±0.08	2.54±0.08	NONE
B20-2	2.03±0.08	2.54±0.08	B2, B3, B4
B20-4	2.03±0.08	2.54±0.08	B2, B3, B4, C2, C4
B20-5	2.03±0.08	2.54±0.08	B2, B3, B4, C2, C3, C4
B20-6	2.16±0.08	2.54±0.08	B2, B3, B4
B20-7	2.03±0.08	2.54±0.08	B3, C3
B20-8	2.03±0.08	2.54±0.08	B2, B4, C2, C4

- NOTES:  
 1. ALL DIMENSIONS ARE IN MILLIMETERS.  
 2. PRODUCT MARKING: NUMBER OF CHARACTERS AND LINES VARY PER PRODUCT.

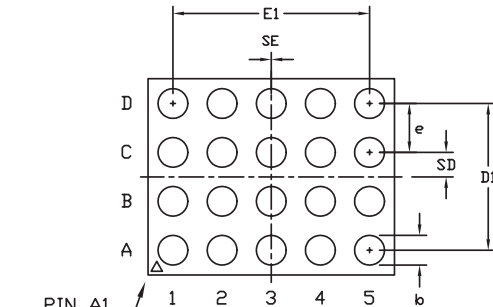

BOTTOM VIEW

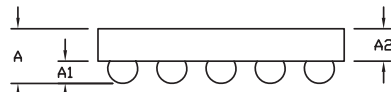

SIDE VIEW

-DRAWING NOT TO SCALE-

TITLE: PACKAGE OUTLINE, 5x4 UCSP		
APPROVAL	DOCUMENT CONTROL NO. 21-0095	REV. J 1/1

**MAX9701**

# **1.3W, Filterless, Stereo Class D Audio Power Amplifier**

## **Revision History**

<b>REVISION NUMBER</b>	<b>REVISION DATE</b>	<b>DESCRIPTION</b>	<b>PAGES CHANGED</b>
3	3/09	Added G45 option to <i>Ordering Information</i>	1

Maxim cannot assume responsibility for use of any circuitry other than circuitry entirely embodied in a Maxim product. No circuit patent licenses are implied. Maxim reserves the right to change the circuitry and specifications without notice at any time.

22 **Maxim Integrated Products, 120 San Gabriel Drive, Sunnyvale, CA 94086 408-737-7600**