





Slim Model of Width 12 mm.

- Ideal for side-by-side mounting.



 Be sure to read *Safety Precautions* on page 5.

Ordering Information

Appearance	Sensing distance			Output specifications		Model	
						Output configuration	
						NO	NC
 Shielded	 2 mm			DC 3-wire models	NPN	TL-T2E1	TL-T2E2
					PNP	TL-T2F1	---
					AC 2-wire models	TL-T2Y1	TL-T2Y2
 Unshielded	 5 mm			DC 3-wire models	NPN	TL-T5ME1	TL-T5ME2
					AC 2-wire models	TL-T5MY1	TL-T5MY2

Note: Models with a different frequency are available. The model numbers are TL-T□□□5. (e.g., TL-T2E15).

Ratings and Specifications

Model		TL-T2E1 TL-T2E2 TL-T2F1	TL-T2Y1 TL-T2Y2	TL-T5ME1 TL-T5ME2	TL-T5MY1 TL-T5MY2
Item					
Sensing distance		2 mm±10%		5 mm±10%	
Setting distance		0 to 1.6 mm		0 to 4 mm	
Differential travel		10% max. of sensing distance			
Sensing object		Ferrous metal (The sensing distance decreases with non-ferrous metal. Refer to <i>Engineering Data</i> on page 3.)			
Standard sensing object		Iron 12 × 12 × 1 mm		Iron 15 × 15 × 1 mm	
Response frequency		E and F models: 800 Hz, Y models: 20 Hz		E models: 250 Hz, Y models: 20 Hz	
Supply voltage (operating voltage range)		E and F models: 12 to 24 VDC (10 to 30 VDC), ripple (p-p): 20% max. Y models: 100 to 220 VAC (90 to 250 VAC) 50/60 Hz			
Current consumption		E and F models: 15 mA max. at 24 VDC			
Leakage current		Y models: 2.5 mA max. at 200 VAC			
Control output	Switching capacity	E and F models: 100 mA max. at 12 VDC, 200 mA max. at 24 VDC Y models: 10 to 200 mA			
	Residual voltage	E and F models: 1.0 V max. with a load current of 100 mA and cord length of 2 m Y models: Refer to <i>Residual Voltage (Typical)</i> on page 3.			
Indicators		Detection indicator (red)			
Operation mode (with sensing object approaching)		E1 models: NO E2 models: NC F1 models: NO Refer to <i>I/O Circuit Diagrams</i> Timing Chart on page 4. Y1 models: NO Y2 models: NC			
Circuit protection		E models: Reverse connection protection and surge absorber Y models: Surge absorber			
Ambient temperature		Operating/Storage: -25°C to 70°C (with no icing or condensation)			
Ambient humidity		Operating/Storage: 35% to 95% (with no condensation)			
Temperature influence		±10% max. of sensing distance at 23% in the temperature range of -25 to 70°C			
Voltage influence		E and F models: ±2.5% max. of sensing distance within a range of ±15% of the rated power supply voltage Y models: ±2.5% max. of sensing distance within a range of ±10% of the rated power supply voltage			
Insulation resistance		50 MΩ min. (at 500 VDC) between case and current-carrying parts			
Dielectric strength		E and F models: 1,000 VAC, 50/60 Hz for 1 min between case and current-carrying parts Y models: 2,000 VAC, 50/60 Hz for 1 min between case and current-carrying parts			
Vibration resistance (destruction)		10 to 55 Hz, 1.5-mm double amplitude for 2 hours each in X, Y, and Z directions			
Shock resistance (destruction)		500 m/s ² for 10 times each in X, Y, and Z directions			
Degree of protection		IEC IP67, in-house standard for oil-resistance			
Connection method		Pre-wired Models (Standard cable length: 2 m)			
Weight (packed state)		Approx. 70 g			
Material	Case	Heat-resistant ABS resin			
	Sensing surface				
Accessories		Instruction sheet			

Engineering Data (Typical)

Operating Range

TL-T2□/T5□

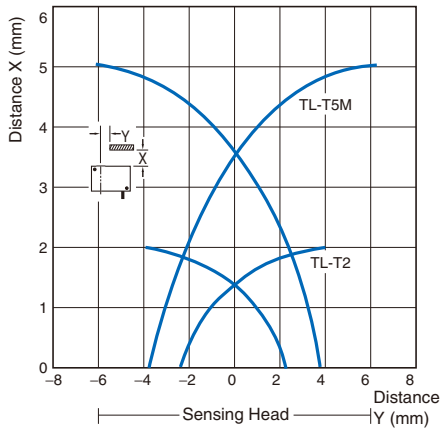

Sensing Object Size and Material Influence

TL-T2

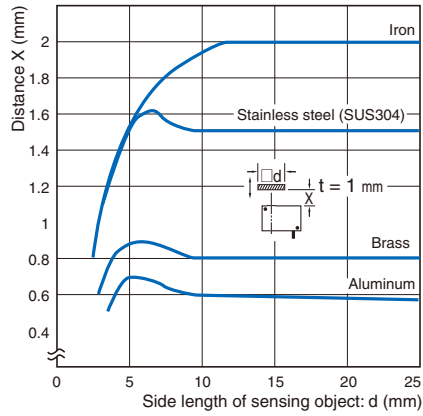

TL-T5M

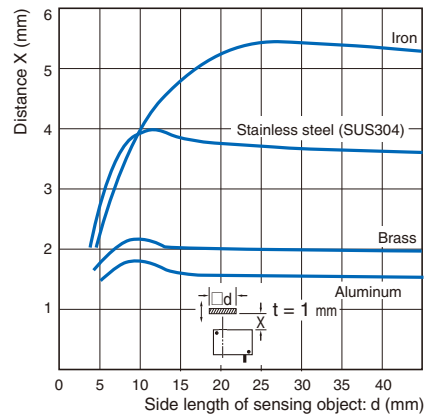

Residual Voltage (Typical)

TL-T□(M)Y□

at 100 VAC

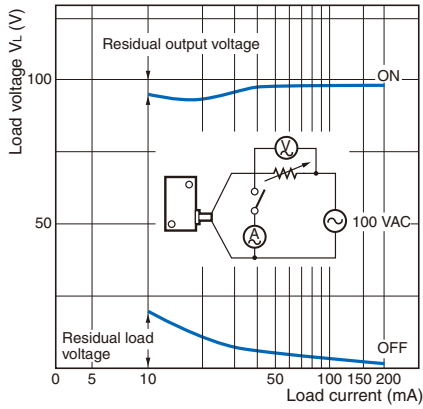

TL-T□(M)Y□

at 200 VAC

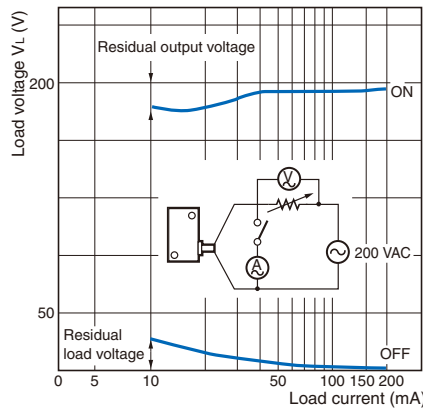





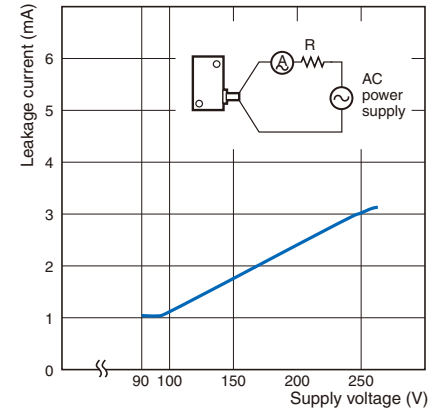





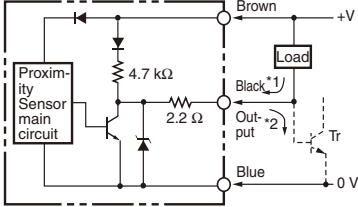

Leakage Current (Typical)

TL-T□Y



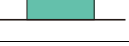



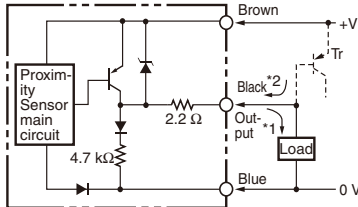

I/O Circuit Diagrams

DC 3-wire Models

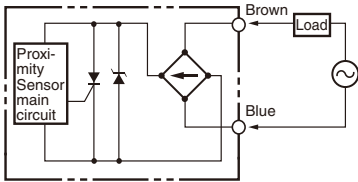
Operation mode	Output specifications	Models	Timing charts	Output circuits
NO	NPN	TL-T2E1 TL-T5ME1	Sensing object Present Not present  Load (between brown and black) Operate Reset  Output voltage (between black and blue) H L  Detection indicator (red) ON OFF 	 <p>*1. 200 mA (load current) *2. When a transistor is connected</p>
		TL-T2E2 TL-T5ME2	Sensing object Present Not present  Load (between brown and black) Operate Reset  Output voltage (between black and blue) H L  Detection indicator (red) ON OFF 	
NO	PNP	TL-T2F1	Sensing object Present Not present  Load (between brown and black) Operate Reset  Output voltage (between black and blue) H L  Detection indicator (red) ON OFF 	 <p>*1. 200 mA (load current) *2. When a transistor is connected</p>

AC 2-wire Models

Operation mode	Models	Timing charts	Output circuits
NO	TL-T2Y1 TL-T5MY1	Sensing object Present Not present  Load Operate Reset  Detection indicator (red) ON OFF 	
NC	TL-T2Y2 TL-T5MY2	Sensing object Present Not present  Load Operate Reset  Detection indicator (red) ON OFF 	

Safety Precautions

⚠ WARNING

This product is not designed or rated for ensuring safety of persons. Do not use it for such purposes.

- Do not short the load. Explosion or burning may result.
 - Do not supply power to the Sensor with no load connected, otherwise internal parts may be damaged or burnt.
- Applicable Models: AC 2-wire Models

Precautions for Correct Use

Do not use this product under ambient conditions that exceed the ratings.

● **Design**

Effect of Surrounding Metals

- Be sure to separate the Sensor from surrounding metal objects as shown in the following illustration.

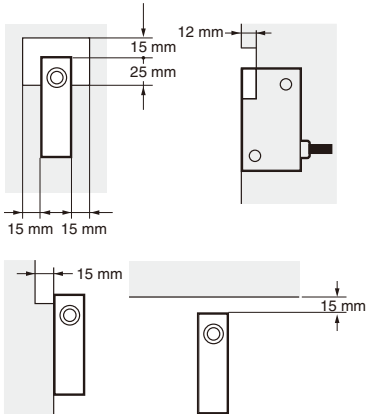

- The TL-T2 will not be influenced by metal when it is embedded in metal.

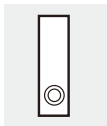

Mutual Interference

When two or more Sensors are mounted face-to-face or side-by-side, separate them as shown below. The table below indicates the minimum distances A and B.

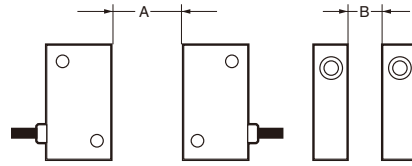

Mutual Interference (Unit: mm)

Model	Distance A	Distance B
TL-T2	40 (10)	12 (0)
TL-T5	120 (60)	80 (40)

Note: Figures in parentheses will apply if the Sensors in use are different from each other in response frequency.

● **Mounting**

- At the time of rear mounting, be sure that the tightening torque does not exceed 0.59 N·m.

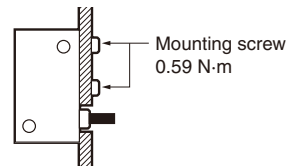

- At the time of side mounting, be sure that the tightening torque does not exceed 0.78 N·m.

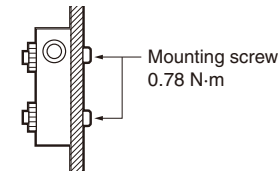

(Unit: mm)

Dimensions

Unless otherwise specified, the tolerance class IT16 is used for dimensions in this data sheet.

TL-T□

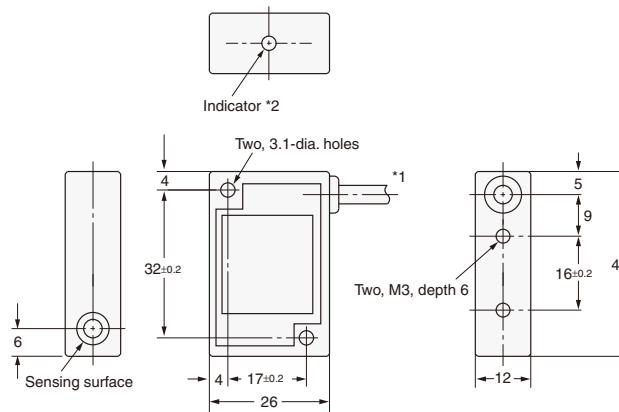
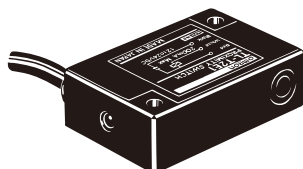

- *1. DC-switching model: 4.0-dia. vinyl-insulated round cable with 3 conductors (Conductor cross section: 0.2 mm², Insulator diameter: 1.2 mm), Standard length: 2 m
- AC-switching model: 4.0-dia. vinyl-insulated round cable with 2 conductors (Conductor cross section: 0.3 mm², Insulator diameter: 1.3 mm), Standard length: 2 m
- *2. Detection indicator (red)

In the interest of product improvement, specifications are subject to change without notice.

Proximity Sensors Technical Guide

For precautions on individual products, refer to the *Safety Precautions* in individual product information.

General Precautions

⚠ WARNING

These products cannot be used in safety devices for presses or other safety devices used to protect human life.



These products are designed for use in applications for sensing workpieces and workers that do not affect safety.

Precautions for Safe Use

To ensure safety, always observe the following precautions.

●Wiring Considerations

Item	Typical examples	
<p>Power Supply Voltage</p> <p>Do not use a voltage that exceeds the operating voltage range. Applying a voltage that is higher than the operating voltage range, or using an AC power supply (100 VAC or higher) for a Sensor that requires a DC power supply may cause explosion or burning.</p>	<p>DC 3-Wire NPN Output Sensors</p>	<p>DC 2-Wire Sensors</p>
<p>Load short-circuiting</p> <ul style="list-style-type: none"> Do not short-circuit the load. Explosion or burning may result. The load short-circuit protection function operates when the power supply is connected with the correct polarity and the power is within the rated voltage range. 	<p>DC 3-Wire NPN Output Sensors</p>	<ul style="list-style-type: none"> DC 2-Wire Sensors Even with the load short-circuit protection function, protection will not be provided when a load short circuit occurs if the power supply polarity is not correct.
<p>Incorrect Wiring</p> <p>Be sure that the power supply polarity and other wiring is correct. Incorrect wiring may cause explosion or burning.</p>	<p>DC 3-Wire NPN Output Sensors</p>	
<p>Connection without a Load</p> <p>If the power supply is connected directly without a load, the internal elements may explode or burn. Be sure to insert a load when connecting the power supply.</p>	<ul style="list-style-type: none"> DC 2-Wire Sensors Even with the load short-circuit protection function, protection will not be provided if both the power supply polarity is incorrect and no load is connected. 	<p>AC 2-Wire Sensors</p>

●Operating Environment

Do not use the Sensor in an environment where there are explosive or combustible gases.

Proximity Sensors Technical Guide

Precautions for Correct Use

The following conditions must be considered to understand the conditions of the application and location as well as the relation to control equipment.

●Model Selection

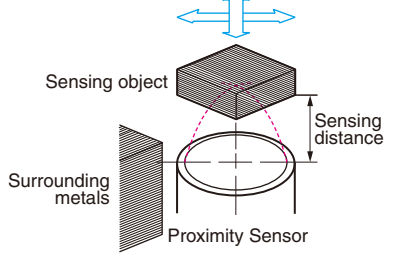
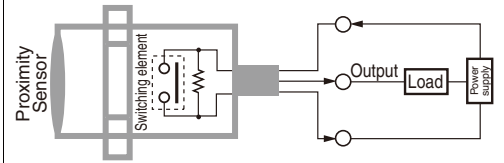
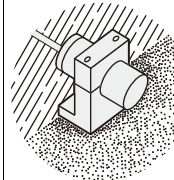
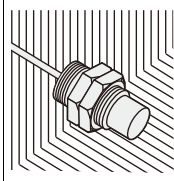
Item	Points of consideration			
<p>Sensing object and operating condition of Proximity Sensor</p> 	<p>Check the relation between the sensing object and the Proximity Sensor.</p>	<p>Specific conditions of object</p> <p>Material, size, shape, existence of plating, etc.</p>	<p>Direction of object movement</p> <p>Transit interval, speed, existence of vibration, etc.</p>	<p>Peripheral metal</p> <p>Material, distance to Sensor, orientation, etc.</p> <p>Sensing distance</p> <p>Fluctuation in transit point, allowable error, etc.</p> <p>Sensing (set) distance, shape of Sensor (rectangular, cylindrical, through-beam, grooved), influence of peripheral metal (Shielded Sensors, Non-shielded Sensors), response speed (response frequency), influence of temperature, influence of voltage, etc.</p>
<p>Electrical conditions</p> 	<p>Verify the electrical conditions of the control system to be used and the electrical performance of the Proximity Sensor.</p>	<p>Power supply</p> <ul style="list-style-type: none"> DC (voltage fluctuation, current capacity value) AC (voltage fluctuation, frequency, etc.) Need for S3D2 Controller 	<p>Load</p> <ul style="list-style-type: none"> Resistive load - Non-contact control system Inductive load - Relay, solenoid, etc. <ul style="list-style-type: none"> Steady-state current, inrush current Operating, reset voltage (current) Lamp load <ul style="list-style-type: none"> Steady-state current, inrush current Open/close frequency 	<p>Selecting the power supply type</p> <ul style="list-style-type: none"> DC DC + S3D2 Controller AC <p>Selecting the power supply type</p> <ul style="list-style-type: none"> DC DC + S3D2 Controller AC <p>Control output</p> <ul style="list-style-type: none"> Maximum current (voltage) Leakage current Residual load voltage
<p>Environmental conditions</p> 	<p>The environmental tolerance of the Proximity Sensor is better than that of other types of Sensors. However, investigate carefully before using a Proximity Sensor under harsh temperatures or in special atmospheres.</p> <p>Temperature and humidity — Highest or lowest values, existence of direct sunlight, etc.</p> <p>Atmosphere — Water, oil, iron powder, or other special chemicals</p> <p>Vibration and shock — Size, duration</p>	<p>Temperature influence, high-temperature use, low temperature use, need for shade, etc.</p> <p>Need for water resistance or oil resistance, need for explosion-proof structure</p> <p>Need for strength, mounting method</p>	<ul style="list-style-type: none"> Water Resistance Do not use the Sensor in water, rain, or outdoors. Ambient Conditions To maintain reliability of operation, do not use the Sensor outside the specified temperature range or outdoors. Even though the Proximity Sensor has a water-resistant structure, it must be covered to prevent direct contact with water or water-soluble cutting oil. Do not use the Sensor in atmospheres with chemical vapors, in particular, strong alkalis or acids (nitric acid, chromic acid, or hot concentrated sulfuric acid). Explosive Atmospheres Do not use the Sensor in atmospheres where there is a danger of explosion. Use an Explosion-proof Sensor. 	
<p>Mounting conditions</p> 	<p>Wiring method, existence of inductance surges</p> <p>Connection</p>	<p>Wires</p> <ul style="list-style-type: none"> Wire type, length, oil-resistant cable, shielded cable, robot cable, etc. <p>Conduits, ducts, pre-wired, terminal wiring, ease of maintenance and inspection</p>	<p>Mounting procedure</p> <p>Installation location</p>	<p>Existence of mounting brackets, direct mounting, secured with bolts or screws</p> <p>Ease of maintenance and inspection, mounting space</p>
<p>Influence of external electromagnetic fields</p>	<ul style="list-style-type: none"> The influence within a DC magnetic field is 20 mT* max. Do not use the Sensor at a level higher than 20 mT. Sudden changes in the DC magnetic field may cause malfunction. Do not use the Sensor for applications that involve turning a DC electromagnet ON and OFF. Do not place a transceiver near the Sensor or its wiring. Doing so may cause malfunction. 			
<p>Other considerations</p>	<p>Cost feasibility: Price/delivery time</p>	<p>Life: Power-ON time/frequency of use</p>		

* mT (millitesla) is a unit for expressing magnetic flux density. One tesla is the equivalent of 10,000 gauss.

●Design

Sensing Object Material

The sensing distance varies greatly depending on the material of the sensing object. Study the engineering data for the influence of sensing object material and size and select a distance with sufficient leeway.

- In general, if the sensing object is a non-magnetic metal (for example, aluminum), the sensing distance decreases.

Example: E2-X10D □

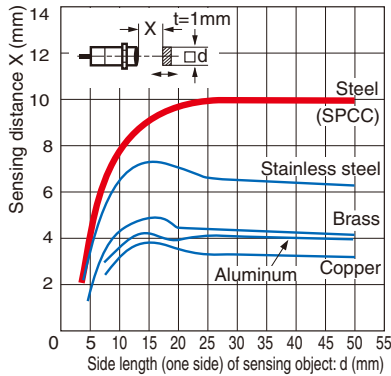

Size of Sensing Object

In general, if the object is smaller than the standard sensing object, the sensing distance decreases.

- Design the setup for an object size that is the same or greater than the standard sensing object size from the graphs showing the sensing object size and sensing distance.
- When the size of the standard sensing object is the same or less than the size of the standard sensing object, select a sensing distance with sufficient leeway.

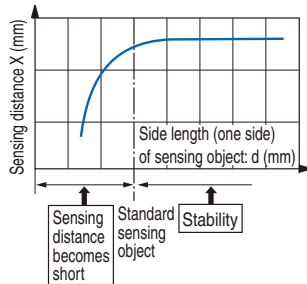

Thickness of Sensing Object

- The thickness of ferrous metals (iron, nickel, etc.) must be 1 mm or greater.
 - For non-magnetic metal, a sensing distance equivalent to a magnetic body can be obtained when the coating thickness is 0.01 mm or less. With pulse-response models (e.g., E2V), however, the characteristics may vary. Be sure to check the catalog information for the relevant model.
- When the coating is extremely thin and is not conductive, such as a vacuum deposited film, detection is not possible.

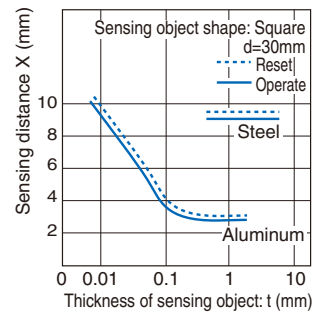

- Influence of Plating If the sensing object is plated, the sensing distance will change (see the table below).

Effect of Plating (Typical)

(Reference values: Percent of non-plated sensing distance)

Thickness and base material of plating	Steel	Brass
No plating	100	100
Zn 5 to 15 μm	90 to 120	95 to 105
Cd 5 to 15 μm	100 to 110	95 to 105
Ag 5 to 15 μm	60 to 90	85 to 100
Cu 10 to 20 μm	70 to 95	95 to 105
Cu 5 to 15 μm	-	95 to 105
Cu (5 to 10 μm) + Ni (10 to 20 μm)	70 to 95	-
Cu (5 to 10 μm) + Ni (10 μm) + Cr (0.3 μm)	75 to 95	-

Mutual Interference

- Mutual interference refers to a state where a Sensor is affected by magnetism (or static capacitance) from an adjacent Sensor and the output is unstable.
- One means of avoiding interference when mounting Proximity Sensors close together is to alternate Sensors with different frequencies. The model tables indicate whether different frequencies are available. Please refer to the tables.
- When Proximity Sensors with the same frequency are mounted together in a line or face-to-face, they must be separated by a minimum distance. For details, refer to *Mutual Interference* in the *Safety Precautions* for individual Sensors.

Power Reset Time

A Sensor is ready for detection within 100 ms after turning ON the power. If the load and Sensor are connected to separate power supplies, design the system so that the Sensor power turns ON first.

Proximity Sensors Technical Guide

Turning OFF the Power

An output pulse may be generated when the power is turned OFF, so design the system so that the load or load line power turns OFF first.

Influence of Surrounding Metal

The existence of a metal object other than the sensing object near the sensing surface of the Proximity Sensor will affect detection performance, increase the apparent operating distance, degrade temperature characteristics, and cause reset failures. For details, refer to the influence of surrounding metal table in *Safety Precautions* for individual Sensors.

The values in the table are for the nuts provided with the Sensors. Changing the nut material will change the influence of the surrounding metal.

Power Transformers

Be sure to use an insulated transformer for a DC power supply. Do not use an auto-transformer (single-coil transformer).

Precautions for AC 2-Wire/DC 2-Wire Sensors

Surge Protection

Although the Proximity Sensor has a surge absorption circuit, if there is a device (motor, welder, etc.) that causes large surges near the Proximity Sensor, insert a surge absorber near the source of the surges.

Influence of Leakage Current

Even when the Proximity Sensor is OFF, a small amount of current runs through the circuit as leakage current.

For this reason, a small current may remain in the load (residual voltage in the load) and cause load reset failures. Verify that this voltage is lower than the load reset voltage (the leakage current is less than the load reset current) before using the Sensor.

Using an Electronic Device as the Load for an AC 2-Wire Sensor

When using an electronic device, such as a Timer, some types of devices use AC half-wave rectification. When a Proximity Sensor is connected to a device using AC half-wave rectification, only AC half-wave power will be supplied to the Sensor. This will cause the Sensor operation to be unstable. Also, do not use a Proximity Sensor to turn the power supply ON and OFF for electronic devices that use DC half-wave rectification. In such a case, use a relay to turn the power supply ON and OFF, and check the system for operating stability after connecting it.

Examples of Timers that Use AC Half-wave Rectification

Timers: H3Y, H3YN, H3RN, H3CA-8, RD2P, and H3CR (-A, -A8, -AP, -F, -G)

Countermeasures for Leakage Current (Examples)

AC 2-Wire Sensors

Connect a bleeder resistor to bypass the leakage current flowing in the load so that the current flowing through the load is less than the load reset current.

When using an AC 2-Wire Sensor, connect a bleeder resistor so that the Proximity Sensor current is at least 10 mA, and the residual load voltage when the Proximity Sensor is OFF is less than the load reset voltage.

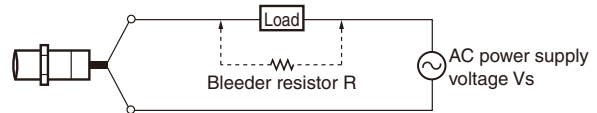

Calculate the bleeder resistance and allowable power using the following equation.

$$R \leq \frac{V_s}{10 - I} \text{ (k}\Omega\text{)} \quad P > \frac{V_s^2}{R} \text{ (mW)}$$

P : Watts of bleeder resistance (the actual number of watts used should be several times this number)

I : Load current (mA)

It is recommended that leeway be included in the actual values used. For 100 VAC, use 10 k Ω or less and 3 W (5 W) or higher, and for 200 VAC, use 20 k Ω or less and 10 W (20 W) or higher. If the effects of heat generation are a problem, use the number of watts in parentheses () or higher.

DC 2-Wire Sensors

Connect a bleeder resistor to bypass the leakage current flowing in the load, and design the load current so that (leakage current) \times (load input impedance) < reset voltage.

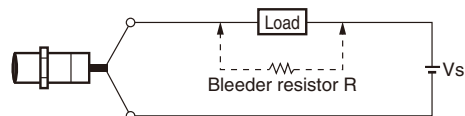

Calculate the bleeder resistance and allowable power using the following equation.

$$R \leq \frac{V_s}{i_R - i_{OFFR}} \text{ (k}\Omega\text{)} \quad P > \frac{V_s^2}{R} \text{ (mW)}$$

P : Watts of bleeder resistance (the actual number of watts used should be several times this number)

i_R : Leakage current of Proximity Sensor (mA)

i_{OFFR} : Load reset current (mA)

It is recommended that leeway be included in the actual values used. For 12 VDC, use 15 k Ω or less and 450 mW or higher, and for 24 VDC, use 30 k Ω or less and 0.1 W or higher.

Loads with Large Inrush Current

Loads, such as lamps or motors, that cause a large inrush current* will weaken or damage the switching element. In this situation, use a relay.

* E2K, TL-N□Y: 1 A or higher

●Mounting

Mounting the Sensor

When mounting a Sensor, do not tap it with a hammer or otherwise subject it to excessive shock. This will weaken water resistance and may damage the Sensor. If the Sensor is being secured with bolts, observe the allowable tightening torque. Some models require the use of toothed washers.

For details, refer to the mounting precautions in *Precautions for Correct Use* in individual product information.

Mounting/Removing Using DIN Track

(Example for E2CY)

<Mounting>

- (1) Insert the front of the Sensor into the special Mounting Bracket (included) or DIN Track.
- (2) Press the rear of the Sensor into the special Mounting Bracket or DIN Track.

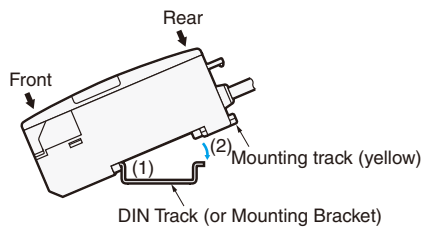

- When mounting the side of the Sensor using the special Mounting Bracket, first secure the Amplifier Unit to the special Mounting Bracket, and then mount the special Mounting Bracket with M3 screws and flat washers with a diameter of 6 mm maximum.

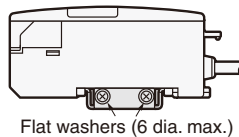

<Removing>

- While pressing the Amplifier Unit in the direction of (3), lift the fiber plug in the direction of (4) for easy removal without a screwdriver.

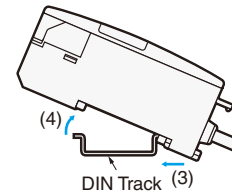

Set Distance

The sensing distance may vary due to fluctuations in temperature and voltage. When mounting the Sensor, it is recommended that installation be based on the set distance.

Proximity Sensors Technical Guide

●Wiring Considerations

AND/OR Connections for Proximity Sensors

Model	Type of connection	Connection	Description
DC 2-Wire	AND (series connection)		<p>Keep the number of connected Sensors (N) within the range of the following equation.</p> $V_s - N \times V_R \geq \text{Operating load voltage}$ <p> N: Number of Sensors that can be connected V_R: Residual output voltage of Proximity Sensor V_s: Power voltage </p> <p>It is possible, however, that the indicators may not light correctly and error pulses (of approximately 1 ms) may be generated because the rated power supply voltage and current are not supplied to individual Proximity Sensors. Verify that this is not a problem before operation.</p>
	OR (parallel connection)		<p>Keep the number of connected Sensors (N) within the range of the following equation.</p> $N \times i \leq \text{Load reset current}$ <p> N: Number of Sensors that can be connected i: Leakage current of Proximity Sensor </p> <p>Example: When an MY (24-VDC) Relay is used as the load, the maximum number of Sensors that can be connected is 4.</p>
AC 2-wire	AND (series connection)		<p><TL-NY, TL-MY, E2K-□MY□, TL-T□Y></p> <p>The above Proximity Sensors cannot be used in a series connection. If needed, connect through relays.</p>
			<p><E2E-X□Y></p> <p>For the above Proximity Sensors, the voltage V_L that can be applied to the load when ON is $V_L = V_s - (\text{Output residual voltage} \times \text{Number of Sensors})$, for both 100 VAC and 200 VAC.</p> <p>The load will not operate unless V_L is higher than the load operating voltage. This must be verified before use.</p> <p>When using two or more Sensors in series with an AND circuit, the limit is three Sensors. (Be careful of the V_s value in the diagram at left.)</p>
	OR (parallel connection)		<p>In general it is not possible to use two or more Proximity Sensors in parallel with an OR circuit.</p> <p>A parallel connection can be used if A and B will not be operated simultaneously and there is no need to hold the load. The leakage current, however, will be n times the value for each Sensor and reset failures will frequently occur. ("n" is the number of Proximity Sensors.)</p> <p>If A and B will be operated simultaneously and the load is held, a parallel connection is not possible.</p> <p>If A and B operate simultaneously and the load is held, the voltages of both A and B will fall to about 10 V when A turns ON, and the load current will flow through A causing random operation. When the sensing object approaches B, the voltage of both terminals of B is too low at 10 V and the switching element of B will not operate. When A turns OFF again, the voltages of both A and B rise to the power supply voltage and B is finally able to turn ON.</p> <p>During this period, there are times when A and B both turn OFF (approximately 10 ms) and the loads are momentarily restored. In cases where the load is to be held in this way, use a relay as shown in the diagram at left.</p>

Note: When AND/OR connections are used with Proximity Sensors, the effects of erroneous pulses or leakage current may prevent use. Verify that there are no problems before use.

Proximity Sensors Technical Guide

Model	Type of connection	Connection	Description
DC 3-wire	AND (series connection)		<p>Keep the number of connected Sensors (N) within the range of the following equation.</p> $i_L + (N - 1) \times i \leq \text{Upper limit of Proximity Sensor control output}$ $V_s - N \times V_R \geq \text{Operating load voltage}$ <p> N: Number of Sensors that can be connected V_R: Residual output voltage of Sensor V_s: Power supply voltage i: Current consumption of Sensor i_L: Load current </p> <p>Note: When an AND circuit is connected, the operation of Proximity Sensor B causes power to be supplied to Proximity Sensor A, and thus erroneous pulses (approximately 1 ms) may be generated in A when the power is turned ON. For this reason, take care when the load has a high response speed because malfunction may result.</p>
	OR (parallel connection)		<p>For Sensors with a current output, a minimum of three OR connections is possible. Whether or not four or more connections is possible depends on the model.</p>

Note: When AND/OR connections are used with Proximity Sensors, the effects of erroneous pulses or leakage current may prevent use. Verify that there are no problems before use.

Extending Cable Length

The cable of a Built-in Amplifier Sensor can be extended to a maximum length of 200 m with each of the standard cables (excluding some models).

For Separate Amplifier Sensors (E2C-EDA, E2C, E2J, E2CY), refer to the specific precautions for individual products.

Bending the Cable

If you need to bend the cable, we recommend a bend radius that is at least 3 times the outer diameter of the cable (with the exception of coaxial and shielded cables).

Cable Tensile Strength

In general, do not subject the cable to a tension greater than that indicated in the following table.

Cable diameter	Tensile strength
Less than 4 mm	30 N max.
4 mm min.	50 N max.

Note: Do not subject a shielded cable or coaxial cable to tension.

Separating High-voltage Lines

Using Metal Conduits

If a power line is to be located near the Proximity Sensor cable, use a separate metal conduit to prevent malfunction or damage. (Same for DC models.)

Example of Connection with S3D2 Sensor Controller

DC 2-Wire Sensors

Using the S3D2 Sensor Controller

Operation can be reversed with the signal input switch on the S3D2.

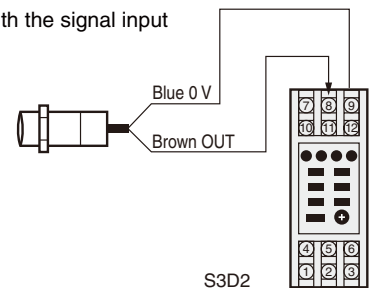

Connecting to a Relay Load

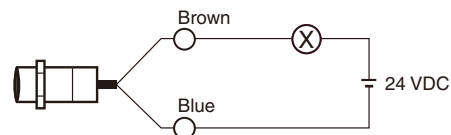

Note: DC 2-Wire Sensors have a residual voltage of 3 V. Check the operating voltage of the relay before use.

The residual voltage of the E2E-XD-M1J-T is 5 V.

DC 3-Wire Sensors

Operation can be reversed with the signal input switch on the S3D2.

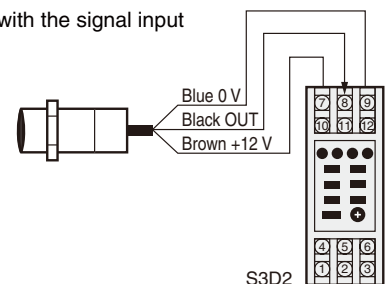

●Operating Environment

Water Resistance

Do not use the Sensor in water, rain, or outdoors.

Ambient Conditions

Do not use the Sensor in the following environments.

Doing so may cause malfunction or failure of the Sensor.

1. To maintain operational reliability and service life, use the Sensor only within the specified temperature range and do not use it outdoors.
2. The Sensor has a water resistant structure, however, attaching a cover to prevent direct contact with water will help improve reliability and prolong product life.
3. Avoid using the Sensor where there are chemical vapors, especially strong alkalis or acids (nitric acid, chromic acid, or hot concentrated sulfuric acid).

●Maintenance and inspection

Periodic Inspection

To ensure long-term stable operation of the Proximity Sensor, inspect for the following on a regular basis. Conduct these inspections also for control devices.

1. Shifting, loosening, or deformation of the sensing object and Proximity Sensor mounting
2. Loosening, bad contact, or wire breakage in the wiring and connections
3. Adherence or accumulation of metal powder
4. Abnormal operating temperature or ambient conditions
5. Abnormal indicator flashing (on setting indicator types)

Disassembly and Repair

Do not under any circumstances attempt to disassemble or repair the product.

Quick Failure Check

You can conveniently check for failures by connecting the E39-VA Handy Checker to check the operation of the Sensor.

Read and Understand This Catalog

Please read and understand this catalog before purchasing the products. Please consult your OMRON representative if you have any questions or comments.

Warranty and Limitations of Liability

WARRANTY

OMRON's exclusive warranty is that the products are free from defects in materials and workmanship for a period of one year (or other period if specified) from date of sale by OMRON.

OMRON MAKES NO WARRANTY OR REPRESENTATION, EXPRESS OR IMPLIED, REGARDING NON-INFRINGEMENT, MERCHANTABILITY, OR FITNESS FOR PARTICULAR PURPOSE OF THE PRODUCTS. ANY BUYER OR USER ACKNOWLEDGES THAT THE BUYER OR USER ALONE HAS DETERMINED THAT THE PRODUCTS WILL SUITABLY MEET THE REQUIREMENTS OF THEIR INTENDED USE. OMRON DISCLAIMS ALL OTHER WARRANTIES, EXPRESS OR IMPLIED.

LIMITATIONS OF LIABILITY

OMRON SHALL NOT BE RESPONSIBLE FOR SPECIAL, INDIRECT, OR CONSEQUENTIAL DAMAGES, LOSS OF PROFITS, OR COMMERCIAL LOSS IN ANY WAY CONNECTED WITH THE PRODUCTS, WHETHER SUCH CLAIM IS BASED ON CONTRACT, WARRANTY, NEGLIGENCE, OR STRICT LIABILITY.

In no event shall responsibility of OMRON for any act exceed the individual price of the product on which liability is asserted.

IN NO EVENT SHALL OMRON BE RESPONSIBLE FOR WARRANTY, REPAIR, OR OTHER CLAIMS REGARDING THE PRODUCTS UNLESS OMRON'S ANALYSIS CONFIRMS THAT THE PRODUCTS WERE PROPERLY HANDLED, STORED, INSTALLED, AND MAINTAINED AND NOT SUBJECT TO CONTAMINATION, ABUSE, MISUSE, OR INAPPROPRIATE MODIFICATION OR REPAIR.

Application Considerations

SUITABILITY FOR USE

OMRON shall not be responsible for conformity with any standards, codes, or regulations that apply to the combination of products in the customer's application or use of the product.

At the customer's request, OMRON will provide applicable third party certification documents identifying ratings and limitations of use that apply to the products. This information by itself is not sufficient for a complete determination of the suitability of the products in combination with the end product, machine, system, or other application or use.

The following are some examples of applications for which particular attention must be given. This is not intended to be an exhaustive list of all possible uses of the products, nor is it intended to imply that the uses listed may be suitable for the products:

- Outdoor use, uses involving potential chemical contamination or electrical interference, or conditions or uses not described in this catalog.
- Nuclear energy control systems, combustion systems, railroad systems, aviation systems, medical equipment, amusement machines, vehicles, safety equipment, and installations subject to separate industry or government regulations.
- Systems, machines, and equipment that could present a risk to life or property.

Please know and observe all prohibitions of use applicable to the products.

NEVER USE THE PRODUCTS FOR AN APPLICATION INVOLVING SERIOUS RISK TO LIFE OR PROPERTY WITHOUT ENSURING THAT THE SYSTEM AS A WHOLE HAS BEEN DESIGNED TO ADDRESS THE RISKS, AND THAT THE OMRON PRODUCT IS PROPERLY RATED AND INSTALLED FOR THE INTENDED USE WITHIN THE OVERALL EQUIPMENT OR SYSTEM.

Disclaimers

CHANGE IN SPECIFICATIONS

Product specifications and accessories may be changed at any time based on improvements and other reasons.

It is our practice to change model numbers when published ratings or features are changed, or when significant construction changes are made. However, some specifications of the product may be changed without any notice. When in doubt, special model numbers may be assigned to fix or establish key specifications for your application on your request. Please consult with your OMRON representative at any time to confirm actual specifications of purchased product.

DIMENSIONS AND WEIGHTS

Dimensions and weights are nominal and are not to be used for manufacturing purposes, even when tolerances are shown.

ERRORS AND OMISSIONS

The information in this catalog has been carefully checked and is believed to be accurate; however, no responsibility is assumed for clerical, typographical, or proofreading errors, or omissions.

PERFORMANCE DATA

Performance data given in this catalog is provided as a guide for the user in determining suitability and does not constitute a warranty. It may represent the result of OMRON's test conditions, and the users must correlate it to actual application requirements. Actual performance is subject to the OMRON Warranty and Limitations of Liability.

PROGRAMMABLE PRODUCTS

OMRON shall not be responsible for the user's programming of a programmable product, or any consequence thereof.

COPYRIGHT AND COPY PERMISSION

This catalog shall not be copied for sales or promotions without permission.

This catalog is protected by copyright and is intended solely for use in conjunction with the product. Please notify us before copying or reproducing this catalog in any manner, for any other purpose. If copying or transmitting this catalog to another, please copy or transmit it in its entirety.