

TO-92

PLASTIC PACKAGE TRANSISTORS (PNP)

Type No.	Maximum Ratings			Electrical Characteristics (Ta=25°C, Unless Otherwise Specified)										C _{ie} (pF) Max	CDIL Case Style										
	V _{CB0} (V) Min	V _{CEO} (V) Min	V _{EBO} (V) Min	I _{CBO} (μA) Max	V _{CB} (V)	h _{FE} Min	h _{FE} Max	I _C (mA)	V _{CE} (V)	V _{CE(Sat)} (V) Max	V _{BE(Sat)} (V) Min	V _{BE(Sat)} (V) Max	I _C (mA)			I _{CES} (μA) Max	V _{CE} (V)	C _{ob} (pF) Min	C _{ob} (pF) Max	f _T (MHz) Min	f _T (MHz) Max	I _C (mA)	t _{off} (ns) Max	NF (dB) Max	Freq (MHz)
BC307B	50	45				200	460	2.00	5.0	0.30			10	.015	50	6.0							10.0	0.001	TO-92-4
BC327	50	45	5	0.100	30	40	300.00	1.0	0.70				500	.100	45	4.0			10				4.0		TO-92-4
BC327-10	50	45	5	0.100	45	40	300.00	1.0	0.70				500	.100	45				10				4.0		TO-92-4
BC327-16	50	45	5	0.100	30	40	250	300.00	1.0	0.70	1.20	500	.100	45					10						TO-92-4
BC327-25	50	45	5	0.100	30	40	400	300.00	1.0	0.70	1.20	500	.100	45					10						TO-92-4
BC327-40	50	45	5	0.100	30	250	600	100.00	1.0	0.70			500	.100	45				10						TO-92-4
BC557	50	45	5			120	800	2.00	5.0	0.30			10	.100	20	6.0	150		10				10.0	0.001	TO-92-4
BC557A	50	45	5			120	220	2.00	5.0	0.30			10	.100	20	6.0	150		10				10.0	0.001	TO-92-4
BC557B	50	45	5			180	400	2.00	5.0	0.30			10	.100	20	6.0	150		10				10.0	0.001	TO-92-4
BC557C	50	45	5			420	800	2.00	5.0	0.30			10	.100	20	6.0	150		10				10.0	0.001	TO-92-4
BC560	50	45	5	0.150	30	125	800	2.00	5.0	0.30			10			6.0	150		10				4.0	0.001	TO-92-4
BC560A	50	45	5	0.150	30	125	250	2.00	5.0	0.30			10			6.0	150		10				4.0	0.001	TO-92-4
BC560B	50	45	5	0.150	30	220	475	2.00	5.0	0.30			10			6.0	150		10				4.0	0.001	TO-92-4
BC560C	50	45	5	0.150	30	420	800	2.00	5.0	0.30			10			6.0	150		10				4.0	0.001	TO-92-4
BC636	45	45	5	0.100	30	25		5.00	2.0	0.50			500					50		10					TO-92-1
BCX79	45	45	5			80	1000	10.00	1.0	0.60	1.00	100	.010	45		4.5							6.0	0.001	TO-92-4
BCX79-7	45	45	5			40		100.00	1.0																TO-92-4
						120	630	2.00	5.0																TO-92-4
						20		0.01	5.0																TO-92-4
						80		10.00	1.0																TO-92-4
						40		100.00	1.0																TO-92-4
						20		0.01	5.0																TO-92-4

PACKAGE TO — 72

PIN CONFIGURATION AVAILABLE IN TO — 72

CDIL CODE STYLE	PIN-1	PIN-2	PIN-3	PIN-4
TO-72	EMITTER	BASE	COLLECTOR	CASE
TO-72-1	BASE	EMITTER	COLLECTOR	CASE
TO-72-2	SOURCE	DRAIN	GATE	CASE

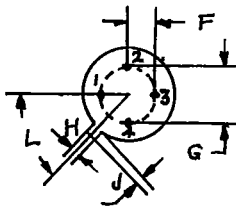
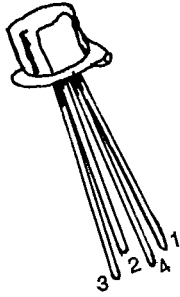
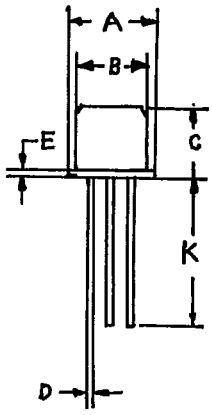

DIM.	MIN	MAX
A	5,24	5,84
B	4,52	4,95
C	4,31	5,33
D	0,40	0,53
E	—	0,76
F	1,14	1,39
G	2,28	2,97
H	0,91	1,17
J	0,71	1,22
K	12,7	—
L	12 DEG.	48 DEG.

ALL DIMENSIONS IN M.M.

PACKAGE TO — 39

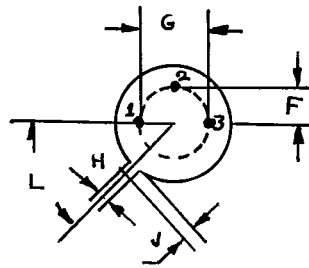
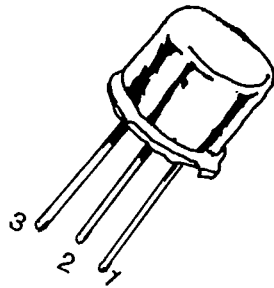
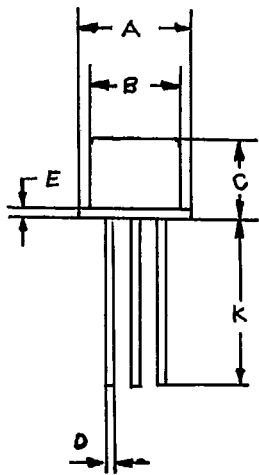

PIN CONFIGURATION:—

1. EMITTER
2. BASE
3. COLLECTOR

DIM.	MIN	MAX
A	8,50	9,39
B	7,74	8,50
C	6,09	6,60
D	0,40	0,53
E	—	0,88
F	2,41	2,66
G	4,82	5,33
H	0,71	0,86
J	0,73	1,02
K	12,7	—
L	42 DEG.	48 DEG.

ALL DIMENSIONS IN M.M.

PACKAGE TO — 18

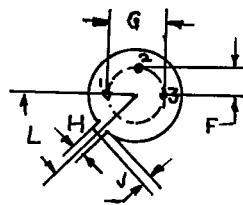
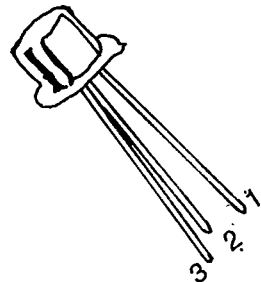
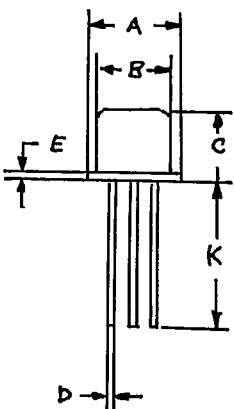

PIN CONFIGURATION:—

1. EMITTER
2. BASE
3. COLLECTOR

DIM.	MIN	MAX
A	5,24	5,84
B	4,52	4,97
C	4,31	5,33
D	0,40	0,53
E	—	0,76
F	—	1,27
G	—	2,97
H	0,91	1,17
J	0,71	1,21
K	12,7	—
L	45 DEG.	

ALL DIMENSIONS IN M.M.

CDIL 373 0000153 2383394 D 63E

INDIA DEVICE CONTINENTAL

PACKAGE TO — 237

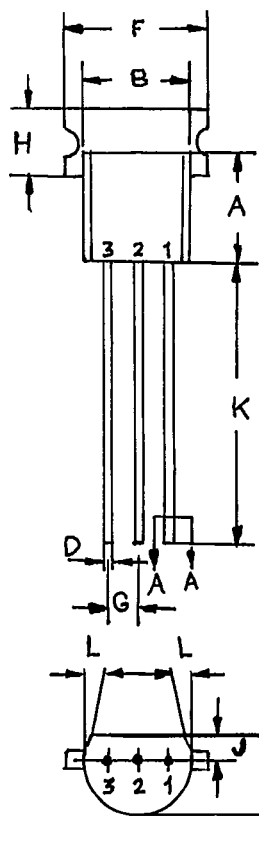

DIM.	MIN	MAX
A	4,32	5,33
B	4,45	5,20
C	3,18	4,19
D	0,41	0,55
E	0,35	0,50
F	—	0,55
G	1,14	1,40
H	—	2,54
K	12,70	—
L	5 DEG.	

ALL DIMENSIONS IN M.M.

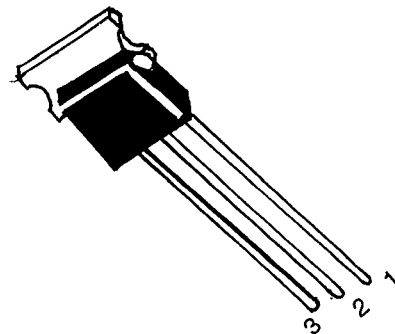

PIN CONFIGURATION AVAILABLE IN TO — 237

CDIL CODE STYLE	PIN 1	PIN 2	PIN 3
TO—237	EMITTER	BASE	COLLECTOR
TO—237—1	BASE	COLLECTOR	EMITTER
TO—237—2	COLLECTOR	BASE	EMITTER

PACKAGE TO — 92

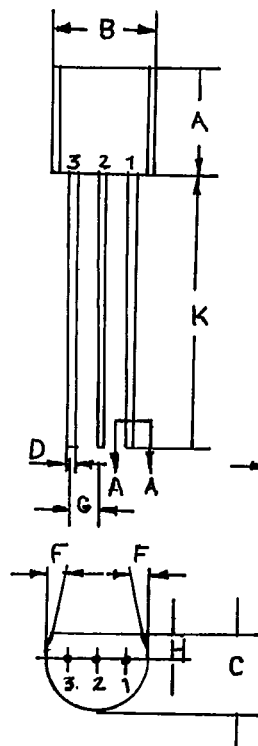

DIM.	MIN	MAX
A	4,32	5,33
B	4,45	5,20
C	3,18	4,19
D	0,41	0,55
E	0,35	0,50
F	5 DEG.	
G	1,14	1,40
H	1,14	1,53
K	12,70	—

ALL DIMENSIONS IN M.M.

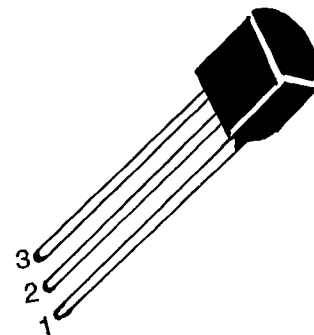

PIN CONFIGURATION AVAILABLE IN TO — 92

CDIL CODE STYLE	PIN 1	PIN 2	PIN 3
TO—92	COLLECTOR	BASE	EMITTER
TO—92—1	BASE	COLLECTOR	EMITTER
TO—92—2	BASE	EMITTER	COLLECTOR
TO—92—3	COLLECTOR	EMITTER	BASE
TO—92—4	EMITTER	BASE	COLLECTOR

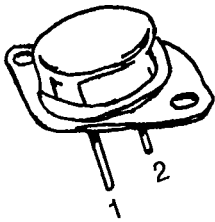

PIN CONFIGURATION:—

1. BASE
2. EMITTER
3. BODY COLLECTOR

PACKAGE TO — 3

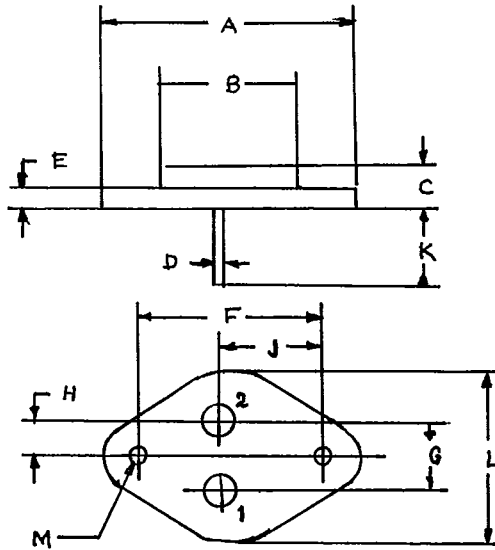

ALL DIMENSIONS ARE IN M.M.

DIM.	MIN	MAX
A	—	39,37
B	—	22,22
C	6,35	8,50
D	0,96	1,09
E	—	1,77
F	29,90	30,4
G	10,69	11,18
H	5,20	5,72
J	16,64	17,15
K	11,15	12,25
L	—	26,67
M	3,84	4,19

PACKAGE TO — 202

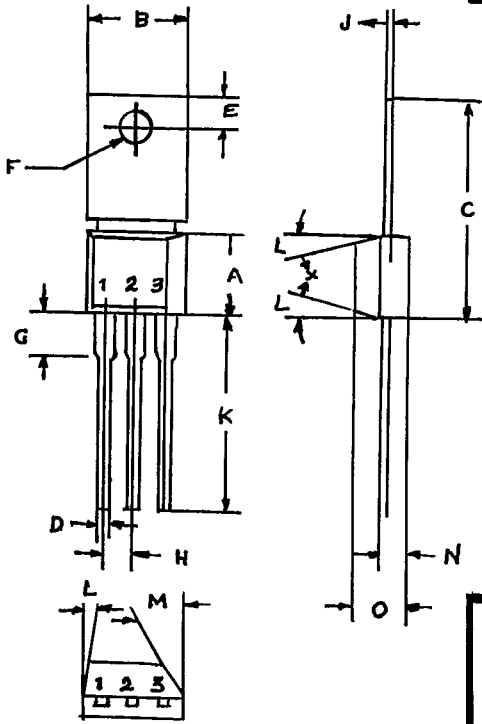

PIN CONFIGURATION:—

1. EMITTER
2. COLLECTOR
3. BASE

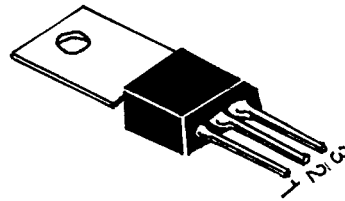

ALL DIMENSIONS IN M.M.

DIM.	MIN	MAX
A	—	8,60
B	—	10,41
C	19,30	21,80
D	0,60	0,80
E	2,80	3,80
F	3,12	3,35
G	1,27	2,54
H	2,41	2,54
J	0,40	0,66
K	9,65	12,20
L	5 DEG.	
M	45 DEG.	
N	0,92	1,78
O	3,30	4,83

PACKAGE TO — 220

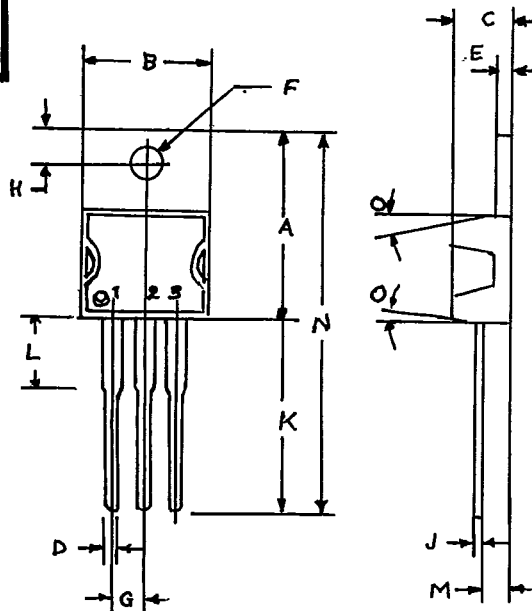

ALL DIMENSIONS IN M.M.

DIM.	MIN	MAX
A	14,22	16,51
B	9,63	10,67
C	3,56	4,83
D	—	0,90
E	1,15	1,40
F	3,75	3,85
G	2,29	2,79
H	2,54	3,43
J	—	0,56
K	12,70	14,73
L	—	6,35
M	2,03	2,92
N	—	31,24
O	7 1/2 DEG.	

PIN CONFIGURATION:—

1. BASE
2. COLLECTOR
3. EMITTER

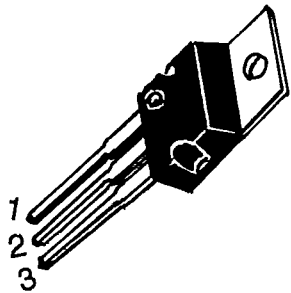

115

CONTINENTAL DEVICE INDIA 63E D 238394 000156 082 CDIL

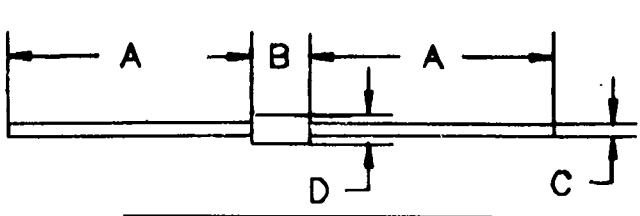

DIM.	MIN	MAX
A	25,40	—
B	3,03	4,44
C	0,46	0,56
D	1,52	2,29

NOTES:—
1. CATHODE IS MARKED BY BAND.
2. ALL DIMENSIONS IN M.M.

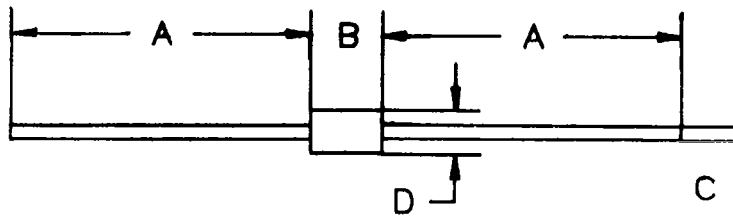

DIM.	MIN	MAX
A	27,90	—
B	4,06	5,51
C	0,71	0,87
D	2,03	2,72

NOTES:—
1. CATHODE IS MARKED BY BAND.
2. ALL DIMENSIONS IN M.M.

PACKAGE TO — 106

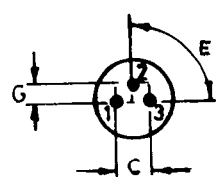
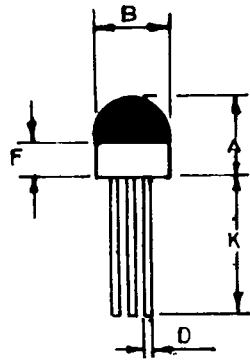

DIM.	MIN	MAX
A	—	6,35
B	—	5,63
C	2,54	
D	0,40	0,55
E	90 DEG.	
F	1,52	—
G	1,27	
K	10,16	—

ALL DIMENSIONS ARE IN M.M.

PIN CONFIGURATION:—
1. EMITTER 2. BASE
3. COLLECTOR

PACKAGE TO — 106

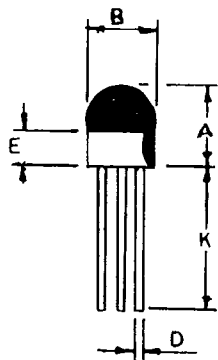

DIM.	MIN	MAX
A	—	6,35
B	—	5,63
C	1,52	
D	0,40	0,55
E	1,52	—
K	10,16	—

ALL DIMENSIONS ARE IN M.M.

PIN CONFIGURATION:—
1. BASE 2. COLLECTOR
3. EMITTER

PACKAGE TO — 105

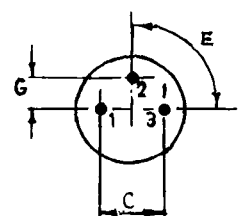
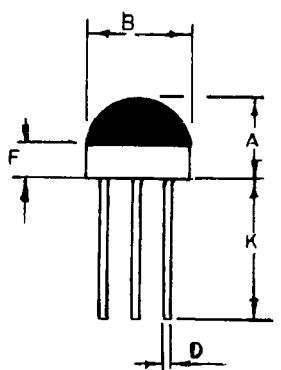

DIM.	MIN	MAX
A	—	6,35
B	—	8,25
C	5,08	
D	0,40	0,55
E	90 DEG.	
F	1,52	—
G	2,54	
K	10,16	—

ALL DIMENSIONS ARE IN M.M.

PIN CONFIGURATION:—
1. EMITTER 2. BASE
3. COLLECTOR

114