

INTRODUCTIONS

1. Designed as a general purpose filter with an IEC connector.
2. Bleeder resistor is added for EG3E, EG3B, EG3R, EW3B, EW3E, EW3R, EG3S numbers with suffix "R".

SPECIFICATIONS

1. Maximum leakage current each line-to-ground @ 115VAC 60Hz: 0.25mA @ 250VAC 50Hz: 0.45mA
2. Hipot rating (one minute) line-to-ground: 2250VDC line-to-line: 1450VDC
3. Operating frequency: 50/60Hz
4. Rated voltage: 115/250VAC

COMPONENTS

PART NO.	Cx (uF)	L (mH)	Cy (pF)
01DEEG3R/-R	0.033	0.26	2200
01DEEW3R/-R		5	
01DEEG3S/-R		5.5	
01DEEG3E/-R	0.015	1.9	3300
01DEEW3E/-R		1.9	
•01DEEG3L	—	0.34	1000
03DEEG3R/-R	0.033	0.18	2200
03DEEW3BS/-R		2.5	
03DEEW3R/-R		1.8	
03DEEG3B/-R	0.015	1.1	3300
03DEEG3S/-R			
03DEEW3B/-R			
03DEEG3E/-R	0.015	1.1	3300
03DEEW3E/-R			
•03DEEG3HA	—	0.032	

PART NO.	Cx (uF)	L (mH)	Cy (pF)
• 03DEEG3L	—	0.08	1000
• 03DEEG3HAX	0.015	0.032	3300
06DEEG3R/-R	0.033	0.072	2200
06DEEW3R/-R		0.5	
06DEEG3S/-R		0.6	
06DEEG3B/-R	0.015	0.55	3300
06DEEW3E/-R		0.55	
*06DEEG3HA	—	0.032	3300
• 06DEEG3L	—	0.016	1000
10DEEG3B/-R	0.033	0.18	2200
10DEEG3S/-R		0.18	
10DEEW3B/-R		0.018	
10DEEW3R/-R	0.033	0.018	2200
10DEEG3R/-R			

- * UL & CSA approved only
- UL, CSA & VDE approved

ELECTRICAL SCHEMATIC

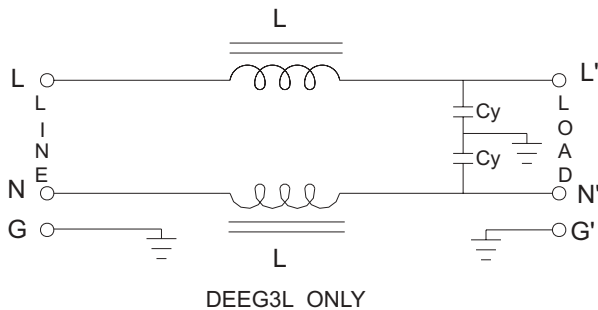
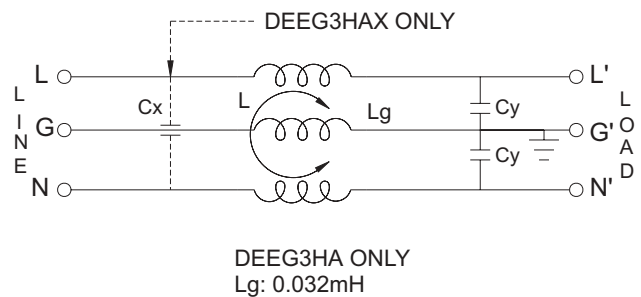
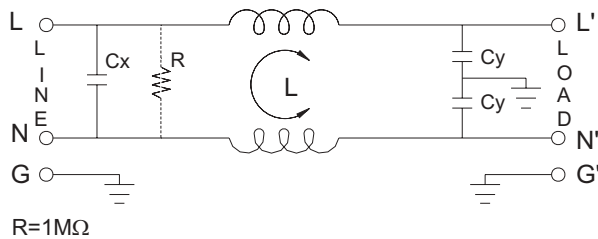

MINIMUM INSERTION LOSS IN dB

COMMON MODE (L-G) IN 50 OHM SYSTEM													
CURRENT RATING	FREQUENCY-MHz						CURRENT RATING	FREQUENCY-MHz					
	.15	.50	1.0	5.0	10	30		.15	.50	1.0	5.0	10	30
1A(E)(S)	22	35	40	45	45	50	1A(R)	7	15	20	40	50	55
3A(E)(S)	18	28	32	45	45	50	3A(R)	5	10	18	35	45	50
6A(E)(S)	12	20	25	40	45	50	6A(R)	1	5	10	30	40	50
10A(S)	4	10	15	30	38	45	10A(R)	0	1	2	18	28	40
6A,3A(HA)	0	1	3	14	21	41	1A(L)	3	10	15	32	30	20
1A(B)	28	40	45	45	45	45	3A(L)	1	2	5	25	25	20
3A(B)	22	30	35	45	45	45	6A(L)	0	0	1	10	15	25
6A(B)	12	20	25	40	45	45							

DIFFERENTIAL MODE (L-L) IN 50 OHM SYSTEM													
CURRENT RATING	FREQUENCY-MHz						CURRENT RATING	FREQUENCY-MHz					
	.15	.50	1.0	5.0	10	30		.15	.50	1.0	5.0	10	30
1A(E)(S)	2	6	40	42	40	40	A(R)	1	5	12	38	38	40
3A(E)(S)	2	3	35	40	40	40	3A(R)	1	5	10	35	35	40
6A(E)(S)	2	3	35	38	40	40	6A(R)	1	5	10	30	30	40
10A(S)	4	8	20	20	30	30	10A(R)	1	5	10	25	30	40
1A(B)	2	10	20	40	42	40	1A(L)	7	1	20	32	27	20
3A(B)	2	5	14	38	40	40	3A(L)	1	5	10	25	25	20
6A(B)	2	5	10	35	38	40	6A(L)	0	0	2	10	15	25

INSERTION LOSS (TYPICAL)

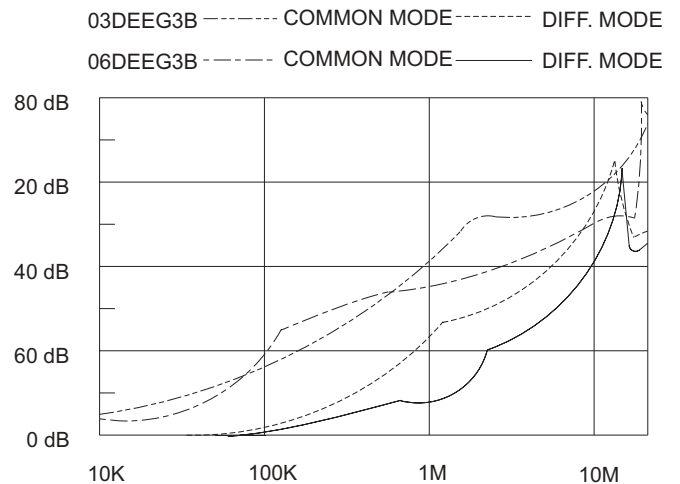
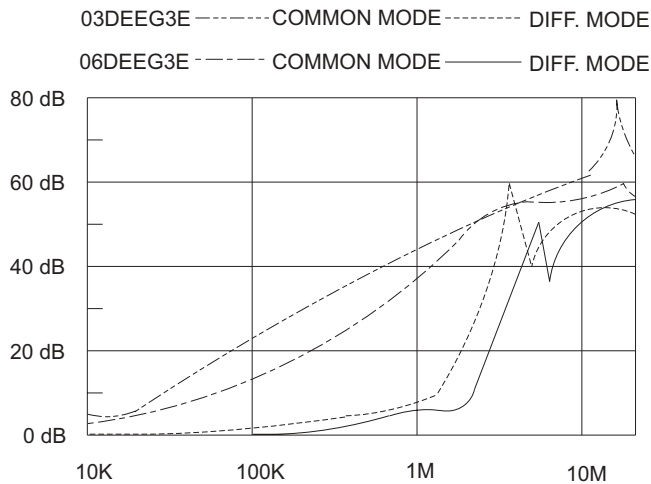

MECHANICAL CONSTRUCTION



EG3E/EG3B/EG3R/EG3L
(Optional Solder Lug)

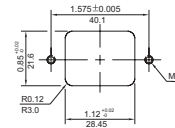
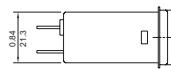
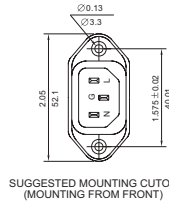
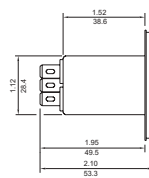

EG3HA

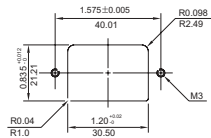
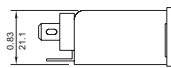
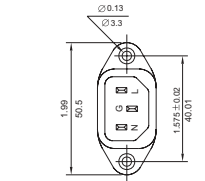
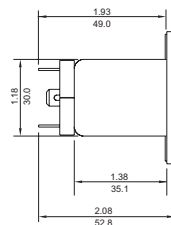

EG3S

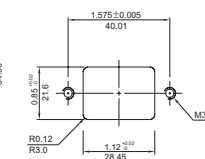
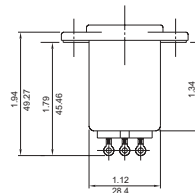
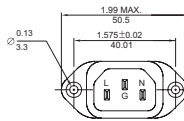

W3BS

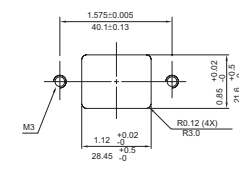
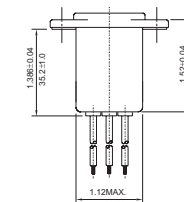
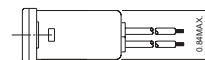
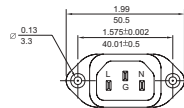

UNIT: $\frac{\text{INCH}}{\text{mm}}$

ALL WIRE LEADS 4.0" LONG MIN.