

## Silicon Avalanche Diodes

1500 Watt Axial Leaded Transient Voltage Suppressors

### RoHS 1.5KE Series



The 1.5KE Series is designed specifically to protect sensitive electronics equipment from voltage transients induced by lightning and other transient voltage events. These devices are ideal for the protection of I/O interfaces, Vcc bus and other vulnerable circuits used in telecom, computer, industrial and consumer electronic applications.

#### FEATURES

- RoHS Compliant
- 6.8V to 550Volts
- Uni-directional and Bi-directional
- Glass passivated chip junction in DO-201 package
- 1500W surge capability at 10/1000µs wave form
- Excellent clamping capability
- Low zener impedance to BV min.
- Typical IR less than 1µA above 10V, (9.5mm) lead length, 5lbs., (2.3kg) tension

**Agency Approvals:** Recognized under the Components Program of Underwriters Laboratories.

**Agency File Number:** E128662

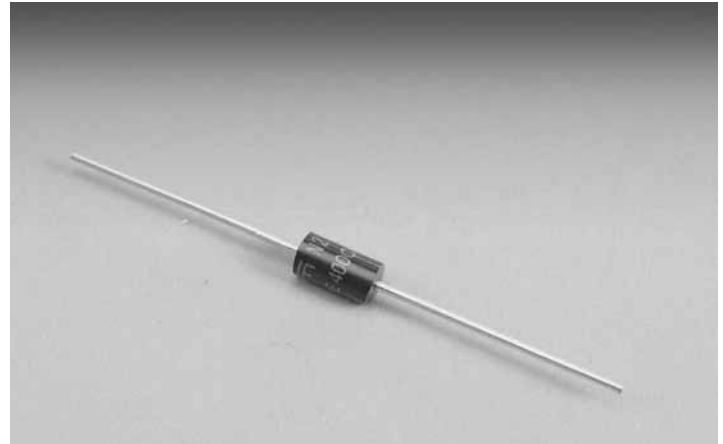

#### MAXIMUM RATINGS AND CHARACTERISTICS @25°C AMBIENT TEMPERATURE (unless otherwise noted)

RATING	SYMBOL	VALUE	UNIT
Peak Pulse Power Dissipation at T <sub>A</sub> =25°C, T <sub>p</sub> =1ms(Note 1)	P <sub>ppm</sub>	Min 1500	Watts
Steady State Power Dissipation at T <sub>L</sub> =75°C, Lead lengths .375", (9.5mm) (Note 2)	P <sub>M(AV)</sub>	6.5	Watts
Superimposed on Rated Load, (JEDEC Method) (Note 3)	I <sub>FSM</sub>	200	Amps
Operating junction and Storage Temperature Range	T <sub>j</sub> , T <sub>STG</sub>	-55 to +175	°C

#### Notes:

1. Non-repetitive current pulse, per Fig.3 and derated above T<sub>A</sub>=25°C per Fig.2
3. 8.3 ms single half sine-wave, or equivalent square wave, Duty cycle= 4 pulses per minutes maximum.

#### ORDERING INFORMATION

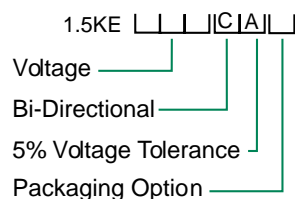

B = Bulk (500 pcs)

T = Tape and reeled (1200 pcs)

#### Mechanical Specifications:

<b>Weight:</b>	0.045 ounce, 1.2 grams
<b>Case:</b>	JEDEC DO-201 Molded plastic
<b>Mounting Position:</b>	Any
<b>Polarity:</b>	Color band denotes cathode except Bipolar
<b>Terminal:</b>	Axial leads, solderable per MIL-STD-750, Method 2026

# Silicon Avalanche Diodes

## 1500 Watt Axial Leaded Transient Voltage Suppressors

### RoHS 1.5KE Series



#### ELECTRICAL SPECIFICATION @ Tamb 25°C

Part Numbers		Reverse Stand off Voltage V <sub>R</sub> (Volts)	Breakdown Voltage V <sub>BR</sub> (Volts) @ I <sub>T</sub>		Test Current I <sub>T</sub> (mA)	Maximum Clamping Voltage V <sub>C</sub> @ I <sub>PP</sub> (Volts)	Maximum Peak Pulse Current I <sub>PP</sub> (A)	Maximum Reverse Leakage I <sub>R</sub> @ V <sub>R</sub> (µA)
Uni-Polar	Bi-Polar		MIN	MAX				
1.5KE6.8A	1.5KE6.8CA	5.80	6.45	7.14	10	10.5	144.8	1000
1.5KE7.5A	1.5KE7.5CA	6.40	7.13	7.88	10	11.3	134.5	500
1.5KE8.2A	1.5KE8.2CA	7.02	7.79	8.61	10	12.1	125.6	200
1.5KE9.1A	1.5KE9.1CA	7.78	8.65	9.50	1	13.4	113.4	50
1.5KE10A	1.5KE10CA	8.55	9.50	10.50	1	14.5	104.8	10
1.5KE11A	1.5KE11CA	9.40	10.50	11.60	1	15.6	97.4	5
1.5KE12A	1.5KE12CA	10.20	11.40	12.60	1	16.7	91.0	5
1.5KE13A	1.5KE13CA	11.10	12.40	13.70	1	18.2	83.5	5
1.5KE15A	1.5KE15CA	12.80	14.30	15.80	1	21.2	71.7	5
1.5KE16A	1.5KE16CA	13.60	15.20	16.80	1	22.5	67.6	5
1.5KE18A	1.5KE18CA	15.30	17.10	18.90	1	25.2	60.3	5
1.5KE20A	1.5KE20CA	17.10	19.00	21.00	1	27.7	54.9	5
1.5KE22A	1.5KE22CA	18.80	20.90	23.10	1	30.6	49.7	5
1.5KE24A	1.5KE24CA	20.50	22.80	25.20	1	33.2	45.8	5
1.5KE27A	1.5KE27CA	23.10	25.70	28.40	1	37.5	40.5	5
1.5KE30A	1.5KE30CA	25.60	28.50	31.50	1	41.4	36.7	5
1.5KE33A	1.5KE33CA	28.20	31.40	34.70	1	45.7	33.3	5
1.5KE36A	1.5KE36CA	30.80	34.20	37.80	1	49.9	30.5	5
1.5KE39A	1.5KE39CA	33.30	37.10	41.00	1	53.9	28.2	5
1.5KE43A	1.5KE43CA	36.80	40.90	45.20	1	59.3	25.6	5
1.5KE47A	1.5KE47CA	40.20	44.70	49.40	1	64.8	23.5	5
1.5KE51A	1.5KE51CA	43.60	48.50	53.60	1	70.1	21.7	5
1.5KE56A	1.5KE56CA	47.80	53.20	58.80	1	77.0	19.7	5
1.5KE62A	1.5KE62CA	53.00	58.90	65.10	1	85.0	17.9	5
1.5KE68A	1.5KE68CA	58.10	64.60	71.40	1	92.0	16.5	5
1.5KE75A	1.5KE75CA	64.10	71.30	78.80	1	103.0	14.8	5
1.5KE82A	1.5KE82CA	70.10	77.90	86.10	1	113.0	13.5	5
1.5KE91A	1.5KE91CA	77.80	86.50	95.50	1	125.0	12.2	5
1.5KE100A	1.5KE100CA	85.50	95.00	105.00	1	137.0	11.1	5
1.5KE110A	1.5KE110CA	94.00	105.00	116.00	1	152.0	10.0	5
1.5KE120A	1.5KE120CA	102.00	114.00	126.00	1	165.0	9.2	5
1.5KE130A	1.5KE130CA	111.00	124.00	137.00	1	179.0	8.5	5
1.5KE150A	1.5KE150CA	128.00	143.00	158.00	1	207.0	7.3	5
1.5KE160A	1.5KE160CA	136.00	152.00	168.00	1	219.0	6.9	5
1.5KE170A	1.5KE170CA	145.00	162.00	179.00	1	234.0	6.5	5
1.5KE180A	1.5KE180CA	154.00	171.00	189.00	1	246.0	6.2	5
1.5KE200A	1.5KE200CA	171.00	190.00	210.00	1	274.0	5.5	5
1.5KE220A	1.5KE220CA	185.00	209.00	231.00	1	328.0	4.6	5
1.5KE250A	1.5KE250CA	214.00	237.00	263.00	1	344.0	4.4	5
1.5KE300A	1.5KE300CA	256.00	285.00	315.00	1	414.0	3.7	5
1.5KE350A	1.5KE350CA	300.00	332.00	368.00	1	482.0	3.2	5
1.5KE400A	1.5KE400CA	342.00	380.00	420.00	1	548.0	2.8	5
1.5KE440A	1.5KE440CA	376.00	418.00	462.00	1	602.0	2.5	5
1.5KE480A	1.5KE480CA	408.00	456.00	504.00	1	658.0	2.3	5
1.5KE510A	1.5KE510CA	434.00	485.00	535.00	1	698.0	2.1	5
1.5KE530A	1.5KE530CA	450.00	503.50	556.50	1	725.0	2.1	5
1.5KE540A	1.5KE540CA	459.00	513.00	567.00	1	740.0	2.0	5
1.5KE550A	1.5KE550CA	467.00	522.50	577.50	1	760.0	2.0	5

For bidirectional type having V<sub>RM</sub> of 10 volts and less, the I<sub>R</sub> limit is double.  
 For parts without A, the V<sub>BR</sub> is ± 10%

6 SILICON DIODE ARRAYS

# Silicon Avalanche Diodes

## 1500 Watt Axial Leaded Transient Voltage Suppressors

### RoHS 1.5KE Series



Ratings and Characteristic Curves  $T_A=25^\circ\text{C}$  unless otherwise noted

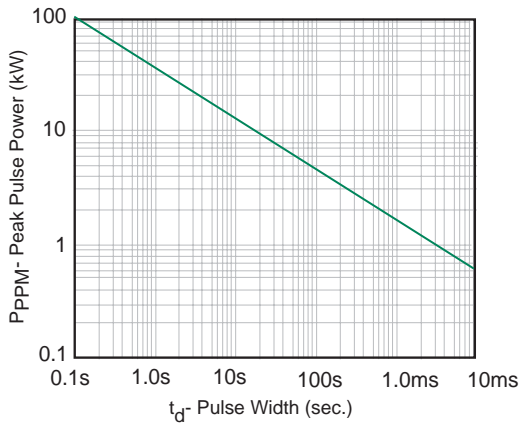

Fig. 1 Peak Pulse Power Rating Curve

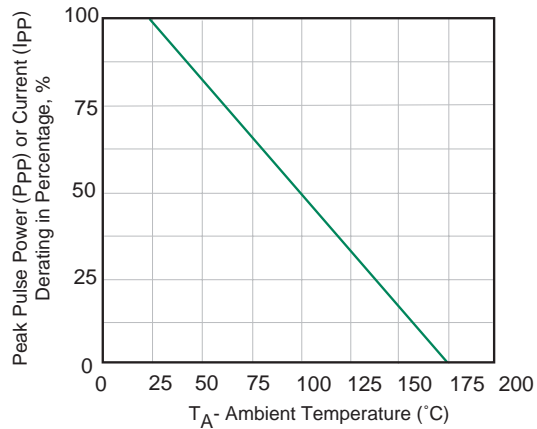

Fig. 2 Pulse Derating Curve

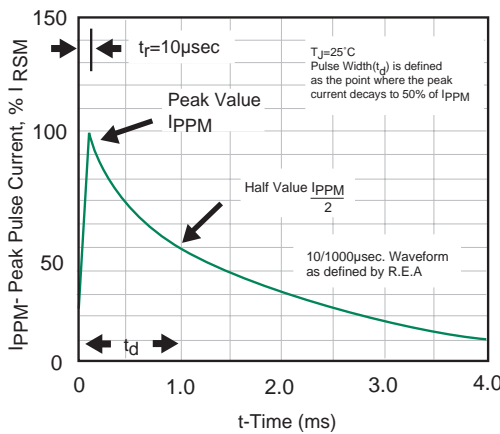

Fig. 3 Pulse Waveform

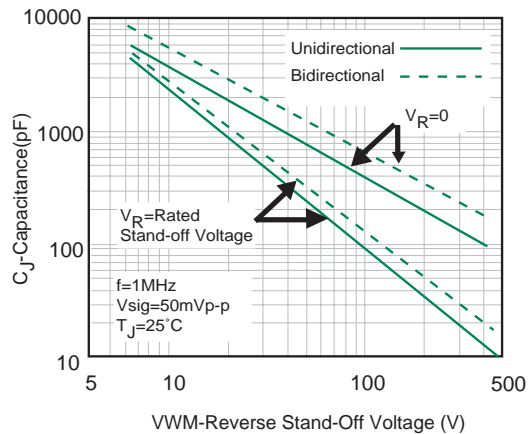

Fig. 4- Typical Junction Capacitance

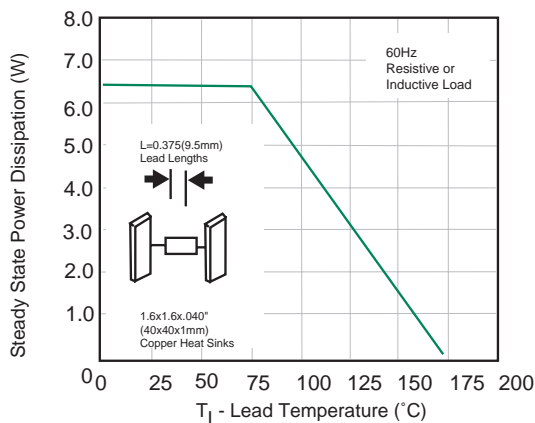

Fig. 5 Steady State Power Derating Curve

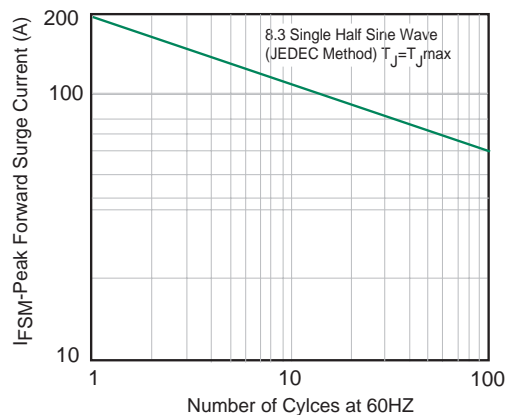

Fig. 6- Maximum Non-Repetitive Forward Surge Current Uni-Directional Only

# Silicon Avalanche Diodes

## 1500 Watt Axial Leaded Transient Voltage Suppressors

### RoHS 1.5KE Series



#### Outline Dimensions

Case Style 1.5KE  
(DO-201)

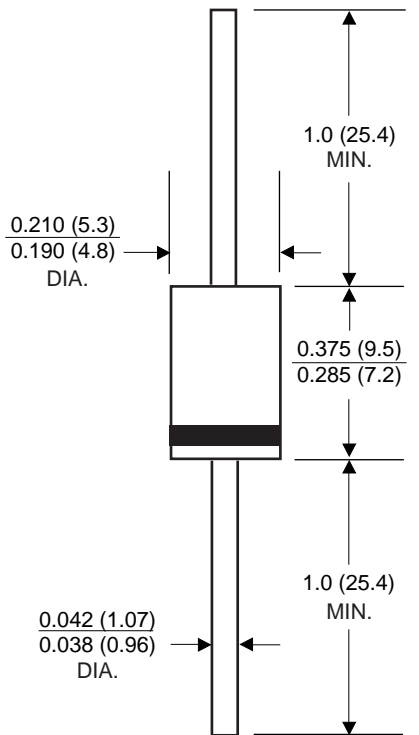

Dimensions in inches and (millimeters)

6  
SILICON DIODE  
ARRAYS