

How to Order

Part Number Explanation



Capacitor Array

EXAMPLE: W2A43C103MAT2A

W	2	A	4	3	C	103	M	A	T	2A
Style W = RoHS L = SnPb	Case Size 1 = 0405 2 = 0508 3 = 0612	Array	Number of Caps	Voltage Z = 10V Y = 16V 3 = 25V 5 = 50V 1 = 100V	Dielectric A = NP0 C = X7R D = X5R	Capacitance Code (In pF) 2 Sig Digits + Number of Zeros	Capacitance Tolerance J = ±5% K = ±10% M = ±20%	Failure Rate A = Commercial 4 = Automotive	Termination Code T = Plated Ni and Sn Z = FLEXITERM® B = 5% min lead X = FLEXITERM® with 5% min lead	Packaging & Quantity Code 2A = 7" Reel (4000) 4A = 13" Reel (10000) 2F = 7" Reel (1000)

NOTE: Contact factory for availability of Termination and Tolerance Options for Specific Part Numbers.

Low Inductance Capacitors (LICC)

EXAMPLE: 0612ZD105MAT2A

0612	Z	D	105	M	A	T	2	A
Size 0306 0508 0612 LD16 LD17 LD18	Voltage 6 = 6.3V Z = 10V Y = 16V 3 = 25V 5 = 50V	Dielectric C = X7R D = X5R	Capacitance Code (In pF) 2 Sig. Digits + Number of Zeros	Capacitance Tolerance K = ±10% M = ±20%	Failure Rate A = N/A	Terminations T = Plated Ni and Sn B = 5% min lead	Packaging Available 2 = 7" Reel 4 = 13" Reel	Thickness See Page 71 for Codes

NOTE: Contact factory for availability of Termination and Tolerance Options for Specific Part Numbers.

Interdigitated Capacitors (IDC)

EXAMPLE: W3L16D225MAT3A

W	3	L	1	6	D	225	M	A	T	3	A
Style W = RoHS L = SnPb	Case Size 2 = 0508 3 = 0612	Low Inductance ESL = 50pH ESL = 60pH	Number of Terminals 1 = 8 Terminals	Voltage 4 = 4V 6 = 6.3V Z = 10V Y = 16V	Dielectric C = X7R D = X5R	Capacitance Code (In pF) 2 Sig. Digits + Number of Zeros	Capacitance Tolerance M = ±20%	Failure Rate A = N/A	Termination T = Plated Ni and Sn B = 5% min Lead	Packaging Available 1=7" Reel 3=13" Reel	Thickness Max. Thickness mm (in.) A=0.95 (0.037) S=0.55 (0.022)

NOTE: Contact factory for availability of Termination and Tolerance Options for Specific Part Numbers.

Low Inductance Decoupling Capacitor Arrays (LICA)

EXAMPLE: LICA3T183M3FC4AA

LICA	3	T	102	M	3	F	C	4	A	A
Style & Size 5V = 9 10V = Z 25V = 3	Voltage 5V = 9 10V = Z 25V = 3	Dielectric D = X5R T = T55T S = High K T55T	Cap/Section (EIA Code) 102 = 1000 pF 103 = 10 nF 104 = 100 nF	Capacitance Tolerance M = ±20% P = GMV	Height Code 6 = 0.500mm 3 = 0.650mm 1 = 0.875mm 5 = 1.100mm 7 = 1.600mm	Termination F = C4 Solder Balls- 97Pb/3Sn H = C4 Solder Balls-Low ESR P = Cr-Cu-Au N = Cr-Ni-Au X = None	Reel Packaging M = 7" Reel R = 13" Reel 6 = 2"x2" Waffle Pack 8 = 2"x2" Black Waffle Pack 7 = 2"x2" Waffle Pack w/ termination facing up A = 2"x2" Black Waffle Pack w/ termination facing up C = 4"x4" Waffle Pack w/ clear lid	# of Caps/Part 1 = one 2 = two 4 = four	Inspection Code A = Standard B = Established Reliability Testing	Code Face A = Bar B = No Bar C = Dot, S55S Dielectrics D = Triangle

Not RoHS Compliant



For RoHS compliant products, please select correct termination style.

NOTE: Contact factory for availability of Termination and Tolerance Options for Specific Part Numbers.



COG (NP0) Dielectric



General Specifications

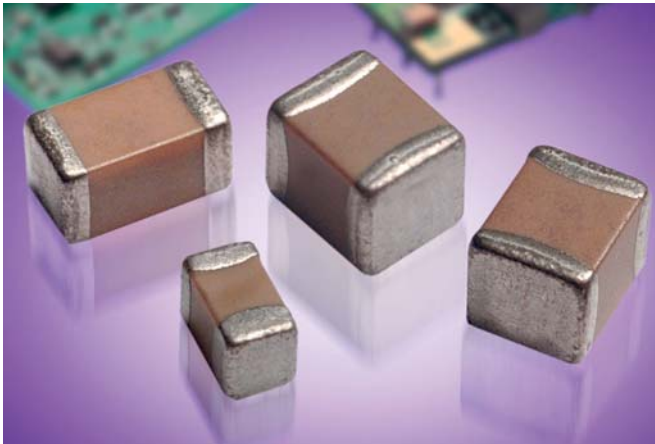

COG (NP0) is the most popular formulation of the "temperature-compensating," EIA Class I ceramic materials. Modern COG (NP0) formulations contain neodymium, samarium and other rare earth oxides.

COG (NP0) ceramics offer one of the most stable capacitor dielectrics available. Capacitance change with temperature is $0 \pm 30 \text{ ppm}/^\circ\text{C}$ which is less than $\pm 0.3\% \Delta C$ from -55°C to $+125^\circ\text{C}$. Capacitance drift or hysteresis for COG (NP0) ceramics is negligible at less than $\pm 0.05\%$ versus up to $\pm 2\%$ for films. Typical capacitance change with life is less than $\pm 0.1\%$ for COG (NP0), one-fifth that shown by most other dielectrics. COG (NP0) formulations show no aging characteristics.



PART NUMBER (see page 2 for complete part number explanation)

0805	5	A	101	J	A	T	2	A
Size (L" x W")	Voltage 6.3V = 6 10V = Z 16V = Y 25V = 3 50V = 5 100V = 1 200V = 2 500V = 7	Dielectric COG (NP0) = A	Capacitance Code (In pF) 2 Sig. Digits + Number of Zeros	Capacitance Tolerance B = $\pm 10 \text{ pF}$ ($< 10 \text{ pF}$) C = $\pm 25 \text{ pF}$ ($< 10 \text{ pF}$) D = $\pm 50 \text{ pF}$ ($< 10 \text{ pF}$) F = $\pm 1\%$ ($\geq 10 \text{ pF}$) G = $\pm 2\%$ ($\geq 10 \text{ pF}$) J = $\pm 5\%$ K = $\pm 10\%$	Failure Rate A = Not Applicable	Terminations T = Plated Ni and Sn 7 = Gold Plated	Packaging 2 = 7" Reel 4 = 13" Reel 7 = Bulk Cass. 9 = Bulk U = 4mm TR (01005)	Special Code A = Std. Product
						Contact Factory For 1 = Pd/Ag Term	Contact Factory For Multiples	

NOTE: Contact factory for availability of Termination and Tolerance Options for Specific Part Numbers. Contact factory for non-specified capacitance values.

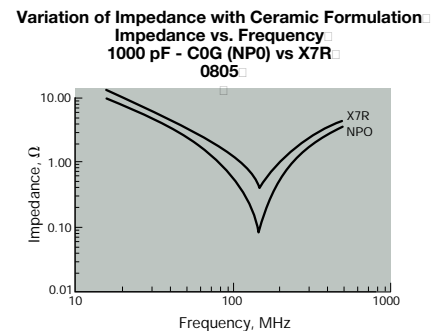
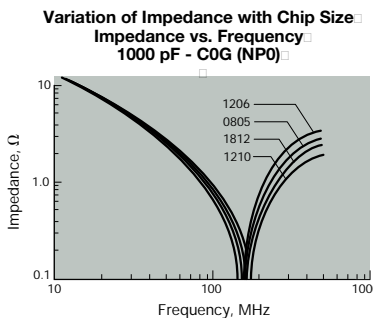
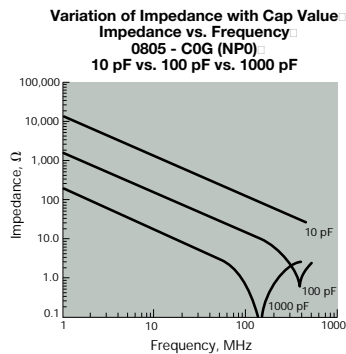
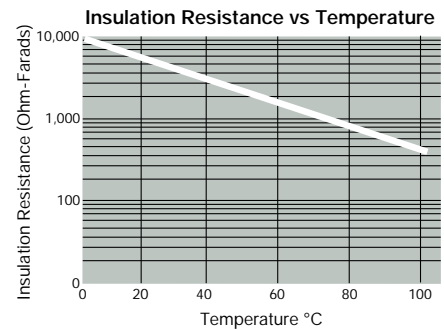
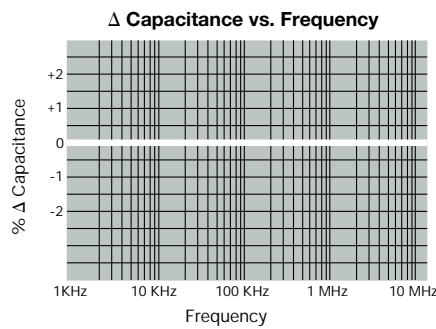
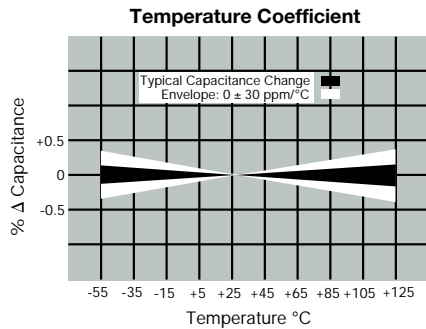

COG (NP0) Dielectric

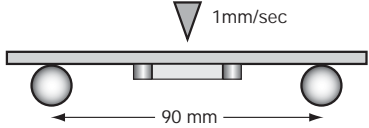

Specifications and Test Methods

Parameter/Test		NP0 Specification Limits	Measuring Conditions	
Operating Temperature Range		-55°C to +125°C	Temperature Cycle Chamber	
Capacitance		Within specified tolerance	Freq.: 1.0 MHz ± 10% for cap ≤ 1000 pF 1.0 kHz ± 10% for cap > 1000 pF Voltage: 1.0Vrms ± .2V	
Q		<30 pF: Q ≥ 400+20 x Cap Value ≥30 pF: Q ≥ 1000	Charge device with rated voltage for 60 ± 5 secs @ room temp/humidity	
Insulation Resistance		100,000MΩ or 1000MΩ - μF, whichever is less	Charge device with 300% of rated voltage for 1-5 seconds, w/charge and discharge current limited to 50 mA (max) Note: Charge device with 150% of rated voltage for 500V devices.	
Dielectric Strength		No breakdown or visual defects	Deflection: 2mm Test Time: 30 seconds 1mm/sec 	
Resistance to Flexure Stresses	Appearance	No defects		
	Capacitance Variation	±5% or ±.5 pF, whichever is greater		
	Q	Meets Initial Values (As Above)		
	Insulation Resistance	≥ Initial Value x 0.3		
Solderability		≥ 95% of each terminal should be covered with fresh solder	Dip device in eutectic solder at 230 ± 5°C for 5.0 ± 0.5 seconds	
Resistance to Solder Heat	Appearance	No defects, <25% leaching of either end terminal	Dip device in eutectic solder at 260°C for 60 seconds. Store at room temperature for 24 ± 2 hours before measuring electrical properties.	
	Capacitance Variation	≤ ±2.5% or ±.25 pF, whichever is greater		
	Q	Meets Initial Values (As Above)		
	Insulation Resistance	Meets Initial Values (As Above)		
Thermal Shock	Dielectric Strength	Meets Initial Values (As Above)	Repeat for 5 cycles and measure after 24 hours at room temperature	
	Appearance	No visual defects	Step 1: -55°C ± 2°	30 ± 3 minutes
	Capacitance Variation	≤ ±2.5% or ±.25 pF, whichever is greater	Step 2: Room Temp	≤ 3 minutes
	Q	Meets Initial Values (As Above)	Step 3: +125°C ± 2°	30 ± 3 minutes
	Insulation Resistance	Meets Initial Values (As Above)	Step 4: Room Temp	≤ 3 minutes
Load Life	Dielectric Strength	Meets Initial Values (As Above)	Charge device with twice rated voltage in test chamber set at 125°C ± 2°C for 1000 hours (+48, -0).	
	Appearance	No visual defects	Remove from test chamber and stabilize at room temperature for 24 hours before measuring.	
	Capacitance Variation	≤ ±3.0% or ± .3 pF, whichever is greater		
	Q (C=Nominal Cap)	≥ 30 pF: Q ≥ 350 ≥10 pF, <30 pF: Q ≥ 275 +5C/2 <10 pF: Q ≥ 200 +10C		
	Insulation Resistance	≥ Initial Value x 0.3 (See Above)		
Load Humidity	Dielectric Strength	Meets Initial Values (As Above)	Store in a test chamber set at 85°C ± 2°C/ 85% ± 5% relative humidity for 1000 hours (+48, -0) with rated voltage applied.	
	Appearance	No visual defects	Remove from chamber and stabilize at room temperature for 24 ± 2 hours before measuring.	
	Capacitance Variation	≤ ±5.0% or ± .5 pF, whichever is greater		
	Q	≥ 30 pF: Q ≥ 350 ≥10 pF, <30 pF: Q ≥ 275 +5C/2 <10 pF: Q ≥ 200 +10C		
Insulation Resistance	Insulation Resistance	≥ Initial Value x 0.3 (See Above)		
	Dielectric Strength	Meets Initial Values (As Above)		

COG (NP0) Dielectric



Capacitance Range

PREFERRED SIZES ARE SHADED

SIZE	0101*		0201		0402			0603				0805					1206						
	Reflow Only		Reflow Only		Reflow/Wave			Reflow/Wave				Reflow/Wave					Reflow/Wave						
Packaging	All Paper		All Paper		All Paper			All Paper				Paper/Embossed					Paper/Embossed						
(L) Length (mm)	0.40 ± 0.02 (0.016 ± 0.0008)		0.60 ± 0.03 (0.024 ± 0.001)		1.00 ± 0.10 (0.040 ± 0.004)			1.60 ± 0.15 (0.063 ± 0.006)				2.01 ± 0.20 (0.079 ± 0.008)					3.20 ± 0.20 (0.126 ± 0.008)						
(W) Width (mm)	0.20 ± 0.02 (0.008 ± 0.0008)		0.30 ± 0.03 (0.011 ± 0.001)		0.50 ± 0.10 (0.020 ± 0.004)			0.81 ± 0.15 (0.032 ± 0.006)				1.25 ± 0.20 (0.049 ± 0.008)					1.60 ± 0.20 (0.063 ± 0.008)						
(t) Terminal (mm)	0.10 ± 0.04 (0.004 ± 0.016)		0.15 ± 0.05 (0.006 ± 0.002)		0.25 ± 0.15 (0.010 ± 0.006)			0.35 ± 0.15 (0.014 ± 0.006)				0.50 ± 0.25 (0.020 ± 0.010)					0.50 ± 0.25 (0.020 ± 0.010)						
WVDC	16		25	50	16	25	50	16	25	50	100	16	25	50	100	200	16	25	50	100	200	500	
Cap (pF)	0.5		A		C	C	C	G	G	G	G	J	J	J	J	J	J	J	J	J	J	J	J
	1.0	B	A		C	C	C	G	G	G	G	J	J	J	J	J	J	J	J	J	J	J	J
	1.2	B	A		C	C	C	G	G	G	G	J	J	J	J	J	J	J	J	J	J	J	J
	1.5	B	A	A	C	C	C	G	G	G	G	J	J	J	J	J	J	J	J	J	J	J	J
	1.8	B	A	A	C	C	C	G	G	G	G	J	J	J	J	J	J	J	J	J	J	J	J
	2.2	B	A	A	C	C	C	G	G	G	G	J	J	J	J	J	J	J	J	J	J	J	J
	2.7	B	A	A	C	C	C	G	G	G	G	J	J	J	J	J	J	J	J	J	J	J	J
	3.3	B	A	A	C	C	C	G	G	G	G	J	J	J	J	J	J	J	J	J	J	J	J
	3.9	B	A	A	C	C	C	G	G	G	G	J	J	J	J	J	J	J	J	J	J	J	J
	4.7	B	A	A	C	C	C	G	G	G	G	J	J	J	J	J	J	J	J	J	J	J	J
	5.6	B	A	A	C	C	C	G	G	G	G	J	J	J	J	J	J	J	J	J	J	J	J
	6.8	B	A	A	C	C	C	G	G	G	G	J	J	J	J	J	J	J	J	J	J	J	J
	8.2	B	A	A	C	C	C	G	G	G	G	J	J	J	J	J	J	J	J	J	J	J	J
	10	B	A	A	C	C	C	G	G	G	G	J	J	J	J	J	J	J	J	J	J	J	J
	12	B	A	A	C	C	C	G	G	G	G	J	J	J	J	J	J	J	J	J	J	J	J
	15	B	A	A	C	C	C	G	G	G	G	J	J	J	J	J	J	J	J	J	J	J	J
	18	B	A	A	C	C	C	G	G	G	G	J	J	J	J	J	J	J	J	J	J	J	J
	22	B	A	A	C	C	C	G	G	G	G	J	J	J	J	J	J	J	J	J	J	J	J
	27		A	A	C	C	C	G	G	G	G	J	J	J	J	J	J	J	J	J	J	J	J
	33		A	A	C	C	C	G	G	G	G	J	J	J	J	J	J	J	J	J	J	J	J
	39		A	A	C	C	C	G	G	G	G	J	J	J	J	J	J	J	J	J	J	J	J
	47		A	A	C	C	C	G	G	G	G	J	J	J	J	J	J	J	J	J	J	J	J
	56		A	A	C	C	C	G	G	G	G	J	J	J	J	J	J	J	J	J	J	J	J
	68		A	A	C	C	C	G	G	G	G	J	J	J	J	J	J	J	J	J	J	J	J
	82		A	A	C	C	C	G	G	G	G	J	J	J	J	J	J	J	J	J	J	J	J
	100		A	A	C	C	C	G	G	G	G	J	J	J	J	J	J	J	J	J	J	J	J
	120				C	C	C	G	G	G	G	J	J	J	J	J	J	J	J	J	J	J	J
	150				C	C	C	G	G	G	G	J	J	J	J	J	J	J	J	J	J	J	J
	180				C	C	C	G	G	G	G	J	J	J	J	J	J	J	J	J	J	J	J
	220				C	C	C	G	G	G	G	J	J	J	J	J	J	J	J	J	J	J	M
	270				C	C	C	G	G	G	G	J	J	J	J	M	J	J	J	J	J	J	M
	330				C	C	C	G	G	G	G	J	J	J	J	M	J	J	J	J	J	J	M
	390				C	C	C	G	G	G	G	J	J	J	J	M	J	J	J	J	J	J	M
	470				C	C	C	G	G	G	G	J	J	J	J	M	J	J	J	J	J	J	M
	560							G	G	G	G	J	J	J	J	M	J	J	J	J	J	J	M
	680							G	G	G	G	J	J	J	J		J	J	J	J	J	J	P
	820							G	G	G	G	J	J	J	J		J	J	J	J	J	J	M
	1000							G	G	G	G	J	J	J	J		J	J	J	J	J	J	Q
	1200											J	J	J	J		J	J	J	J	J	J	Q
	1500											J	J	J	J		J	J	J	J	M	J	Q
	1800											J	J	J			J	J	M	M			
	2200											J	J	N			J	J	M	P			
	2700											J	J	N			J	J	M	P			
	3300											J	J				J	J	M	P			
	3900											J	J				J	J	M	P			
	4700											J	J				J	J	M	P			
	5600																J	J	M				
	6800																J	M					
	8200																M	M					
Cap (µF)	0.010																M	M					
	0.012																M	M					
	0.015																						
	0.018																						
	0.022																						
	0.027																						
	0.033																						
	0.039																						
	0.047																						
	0.068																						
	0.082																						
	0.1																						
WVDC	16		25	50	16	25	50	16	25	50	100	16	25	50	100	200	16	25	50	100	200	500	

Letter	A	B	C	E	G	J	K	M	N	P	Q	X	Y	Z
Max. Thickness	0.33 (0.013)	0.22 (0.009)	0.56 (0.022)	0.71 (0.028)	0.90 (0.035)	0.94 (0.037)	1.02 (0.040)	1.27 (0.050)	1.40 (0.055)	1.52 (0.060)	1.78 (0.070)	2.29 (0.090)	2.54 (0.100)	2.79 (0.110)
	PAPER						EMBOSS							

*EIA 01005



COG (NP0) Dielectric



Capacitance Range

PREFERRED SIZES ARE SHADED

SIZE		1210					1812					1825					2220					2225				
Soldering		Reflow Only					Reflow Only					Reflow Only					Reflow Only					Reflow Only				
Packaging		Paper/Embossed					All Embossed					All Embossed					All Embossed					All Embossed				
(L) Length	mm (in.)	3.20 ± 0.20 (0.126 ± 0.008)					4.50 ± 0.30 (0.177 ± 0.012)					4.50 ± 0.30 (0.177 ± 0.012)					5.70 ± 0.40 (0.225 ± 0.016)					5.72 ± 0.25 (0.225 ± 0.010)				
(W) Width	mm (in.)	2.50 ± 0.20 (0.098 ± 0.008)					3.20 ± 0.20 (0.126 ± 0.008)					6.40 ± 0.40 (0.252 ± 0.016)					5.00 ± 0.40 (0.197 ± 0.016)					6.35 ± 0.25 (0.250 ± 0.010)				
(t) Terminal	mm (in.)	0.50 ± 0.25 (0.020 ± 0.010)					0.61 ± 0.36 (0.024 ± 0.014)					0.61 ± 0.36 (0.024 ± 0.014)					0.64 ± 0.39 (0.025 ± 0.015)					0.64 ± 0.39 (0.025 ± 0.015)				
WVDC		25	50	100	200	500	25	50	100	200	500	50	100	200	50	100	200	50	100	200	50	100	200			
Cap (pF)	0.5																									
	1.0																									
	1.2																									
	1.5																									
	1.8																									
	2.2																									
	2.7																									
	3.3																									
	3.9																									
	4.7																									
	5.6																									
	6.8																									
	8.2																									
	10					J																				
	12					J																				
	15					J																				
	18					J																				
	22					J																				
	27					J																				
	33					J																				
	39					J																				
	47					J																				
	56					J																				
	68					J																				
	82					J																				
	100					J																				
	120					J																				
	150					J																				
	180					J																				
	220					J																				
	270					J																				
	330					J																				
	390					M																				
	470					M																				
	560	J	J	J	J	M																				
	680	J	J	J	J	M																				
	820	J	J	J	J	M																				
	1000	J	J	J	J	M	K	K	K	K	M	M	M	M							M	M	P			
	1200	J	J	J	M	M	K	K	K	K	M	M	M	M							M	M	P			
	1500	J	J	J	M	M	K	K	K	K	M	M	M	M							M	M	P			
	1800	J	J	J	M		K	K	K	K	M	M	M	M							M	M	P			
	2200	J	J	J	Q		K	K	K	K	P	M	M	M							M	M	P			
	2700	J	J	J	Q		K	K	K	P	Q	M	M	M							M	M	P			
	3300	J	J	J			K	K	K	P	Q	M	M	M				X			M	M	P			
	3900	J	J	M			K	K	K	P	Q	M	M	M				X			M	M	P			
	4700	J	J	M			K	K	K	P	Q	M	M	M				X	X		M	M	P			
	5600	J	J				K	K	M	P	X	M	M	M	X	X	X	X	X	X	M	M	P			
	6800	J	J				K	K	M	X		M	M	M	X	X	X	X	X	X	M	M	P			
	8200	J	J				K	M	M			M	M	M	X	X	X	X	X	X	M	M	P			
Cap (µF)	0.010	J	J				K	M	M			M	M	M	X	X	X	X	X	X	M	M	P			
	0.012	J	J				K	M				M	M	M	X	X	X	X	X	X	M	M	P			
	0.015						M	M				M	M	M	X	X	X	X	X	X	M	M	Y			
	0.018						M	M				P	M		X	X	X	X			M	M	Y			
	0.022						M	M				P			X	X					M	Y	Y			
	0.027						M	M				P			X	X					P	Y	Y			
	0.033						M	M				P			X	X					P					
	0.039						M	M				P			Y						P					
	0.047						M	M				P			Y						P					
	0.068						M	M													P					
	0.082						M	M													Q					
	0.1																				Q					
WVDC		25	50	100	200	500	25	50	100	200	500	50	100	200	50	100	200	50	100	200	50	100	200			
SIZE		1210					1812					1825					2220					2225				
Letter		A	C	E	G	J	K	M	N	P	Q	X	Y	Z												
Max. Thickness		0.33 (0.013)	0.56 (0.022)	0.71 (0.028)	0.90 (0.035)	0.94 (0.037)	1.02 (0.040)	1.27 (0.050)	1.40 (0.055)	1.52 (0.060)	1.78 (0.070)	2.29 (0.090)	2.54 (0.100)	2.79 (0.110)												
		PAPER					EMBOSSSED																			

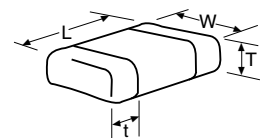

RF/Microwave COG (NP0) Capacitors (RoHS)



Ultra Low ESR, "U" Series, COG (NP0) Chip Capacitors

GENERAL INFORMATION

"U" Series capacitors are COG (NP0) chip capacitors specially designed for "Ultra" low ESR for applications in the communications market. Max ESR and effective capacitance

are met on each value producing lot to lot uniformity. Sizes available are EIA chip sizes 0402, 0603, 0805, and 1210.

DIMENSIONS: inches (millimeters)

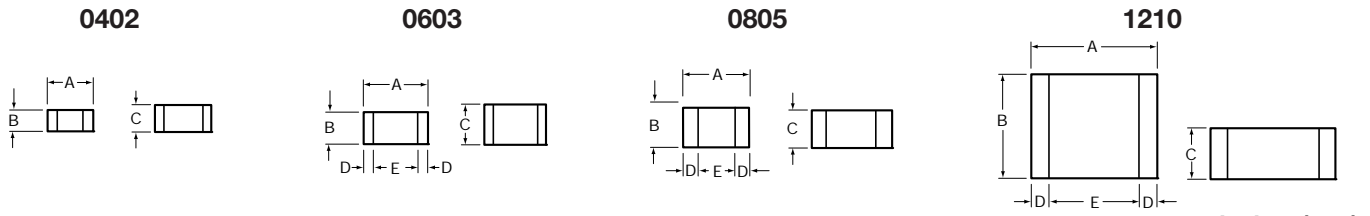

Size	A	B	C	D	E
0402	0.039±0.004 (1.00±0.1)	0.020±0.004 (0.50±0.1)	0.024 (0.6) max	N/A	N/A
0603	0.060±0.010 (1.52±0.25)	0.030±0.010 (0.76±0.25)	0.036 (0.91) max	0.010±0.005 (0.25±0.13)	0.030 (0.76) min
0805	0.079±0.008 (2.01±0.2)	0.049±0.008 (1.25±0.2)	0.040±0.005 (1.02±0.127)	0.020±0.010 (0.51±0.255)	0.020 (0.51) min
1210	0.126±0.008 (3.2±0.2)	0.098±0.008 (2.49±0.2)	0.050±0.005 (1.27±0.127)	0.025±0.015 (0.635±0.381)	0.040 (1.02) min

HOW TO ORDER

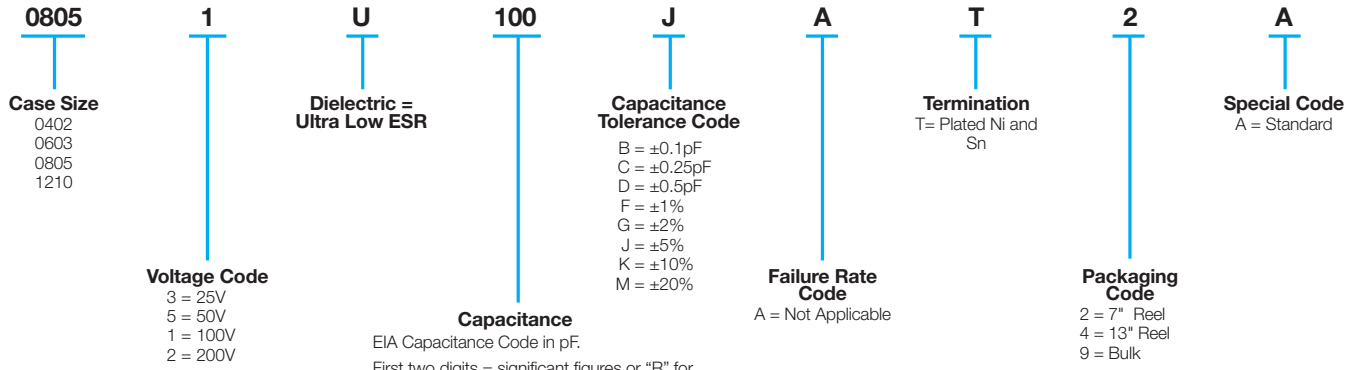

NOTE: Contact factory for availability of Termination and Tolerance Options for Specific Part Numbers.

ELECTRICAL CHARACTERISTICS

Capacitance Values and Tolerances:

- Size 0402 - 0.2 pF to 22 pF @ 1 MHz
- Size 0603 - 1.0 pF to 100 pF @ 1 MHz
- Size 0805 - 1.6 pF to 160 pF @ 1 MHz
- Size 1210 - 2.4 pF to 1000 pF @ 1 MHz

Temperature Coefficient of Capacitance (TC):

0±30 ppm/°C (-55° to +125°C)

Insulation Resistance (IR):

- 10¹² Ω min. @ 25°C and rated WVDC
- 10¹¹ Ω min. @ 125°C and rated WVDC

Working Voltage (WVDC):

- Size Working Voltage
- 0402 - 50, 25 WVDC
- 0603 - 200, 100, 50 WVDC
- 0805 - 200, 100 WVDC
- 1210 - 200, 100 WVDC

Dielectric Working Voltage (DWV):

250% of rated WVDC

Equivalent Series Resistance Typical (ESR):

- 0402 - See Performance Curve, page 9
- 0603 - See Performance Curve, page 9
- 0805 - See Performance Curve, page 9
- 1210 - See Performance Curve, page 9

Marking: Laser marking EIA J marking standard

(except 0603) (capacitance code and tolerance upon request).

MILITARY SPECIFICATIONS

Meets or exceeds the requirements of MIL-C-55681



RF/Microwave C0G (NP0) Capacitors (RoHS)



Ultra Low ESR, "U" Series, C0G (NP0) Chip Capacitors

CAPACITANCE RANGE

Cap (pF)	Available Tolerance	Size				Cap (pF)	Available Tolerance	Size				Cap (pF)	Available Tolerance	Size				Cap (pF)	Available Tolerance	Size				
		0402	0603	0805	1210			0402	0603	0805	1210			0402	0603	0805	1210			0402	0603	0805	1210	
0.2	B,C	50V	N/A	N/A	N/A	1.0	B,C,D	50V	200V	200V	200V	7.5	B,C,J,K,M	50V	200V	200V	200V	100	F,G,J,K,M	N/A	100V	200V	200V	
0.3	B,C	↓	↓	↓	↓	1.1	↓	↓	↓	↓	↓	8.2	↓	↓	↓	↓	↓	110	↓	↓	50V	↓	↓	↓
0.4	B,C	↓	↓	↓	↓	1.2	↓	↓	↓	↓	↓	9.1	B,C,J,K,M	↓	↓	↓	↓	120	↓	↓	50V	↓	↓	↓
0.5	B,C	↓	↓	↓	↓	1.3	↓	↓	↓	↓	↓	10	F,G,J,K,M	↓	↓	↓	↓	130	↓	↓	50V	↓	↓	↓
0.6	B,C,D	↓	↓	↓	↓	1.4	↓	↓	↓	↓	↓	11	↓	↓	↓	↓	↓	140	↓	↓	N/A	↓	↓	↓
0.7	B,C,D	↓	↓	↓	↓	1.5	↓	↓	↓	↓	↓	12	↓	↓	↓	↓	↓	150	↓	↓	↓	↓	↓	↓
0.8	B,C,D	↓	↓	↓	↓	1.6	↓	↓	↓	↓	↓	13	↓	↓	↓	↓	↓	160	↓	↓	↓	↓	↓	↓
0.9	B,C,D	↓	↓	↓	↓	1.7	↓	↓	↓	↓	↓	15	↓	↓	↓	↓	↓	180	↓	↓	↓	↓	↓	↓
						1.8						18						200			↓	↓	↓	
						1.9						20						220			↓	↓	↓	
						2.0						22						270			↓	↓	↓	
						2.1						24						300			↓	↓	↓	
						2.2						27						330			↓	↓	↓	
						2.4						30						360			↓	↓	↓	
						2.7						33						390			↓	↓	↓	
						3.0						36						430			↓	↓	↓	
						3.3						39						470			↓	↓	↓	
						3.6						43						510			↓	↓	↓	
						3.9						47						560			↓	↓	↓	
						4.3						51						620			↓	↓	↓	
						4.7						56						680			↓	↓	↓	
						5.1						68						750			↓	↓	↓	
						5.6						75						820			↓	↓	↓	
						6.2	B,C,D					82						910			↓	↓	↓	
						6.8	B,C,J,K,M					91						1000	F,G,J,K,M		↓	↓	↓	

ULTRA LOW ESR, "U" SERIES

TYPICAL ESR vs. FREQUENCY
0402 "U" SERIES

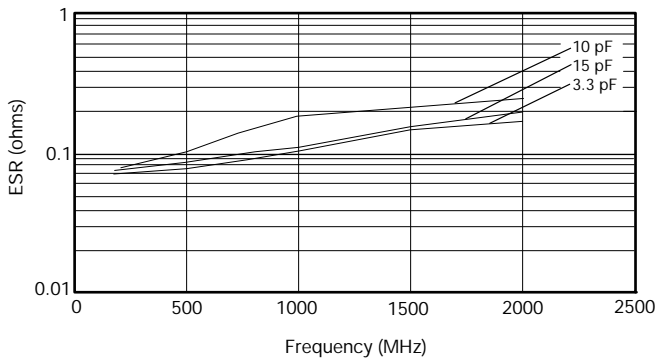

TYPICAL ESR vs. FREQUENCY
0603 "U" SERIES

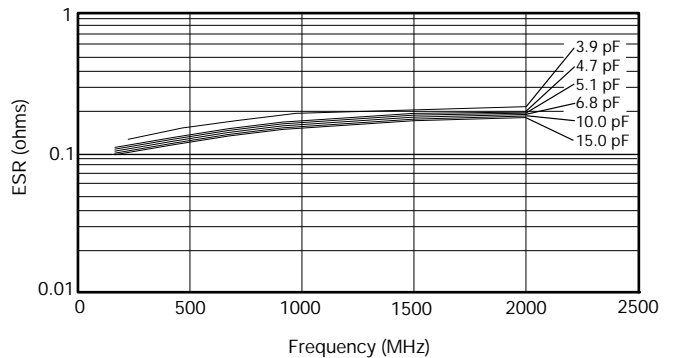

TYPICAL ESR vs. FREQUENCY
0805 "U" SERIES

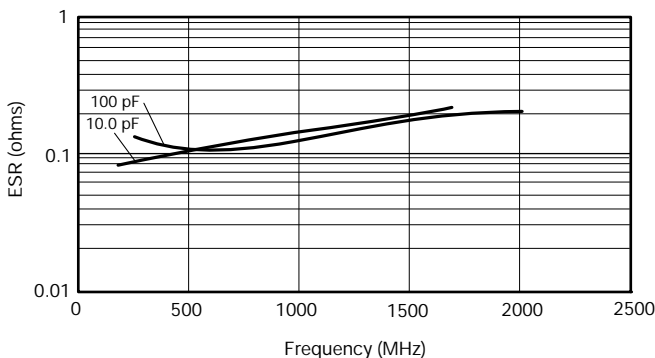

TYPICAL ESR vs. FREQUENCY
1210 "U" SERIES

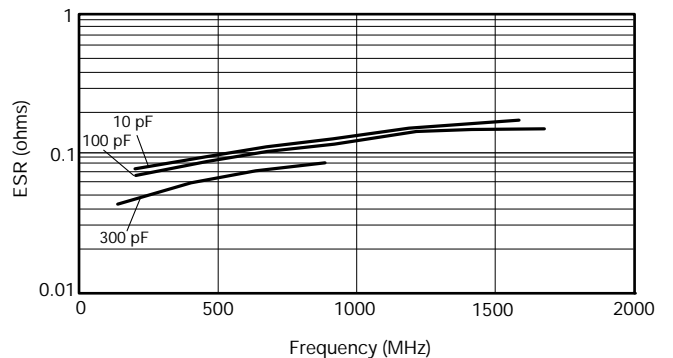

ESR Measured on the Boonton 34A



RF/Microwave C0G (NP0) Capacitors



Ultra Low ESR, "U" Series, C0G (NP0) Chip Capacitors

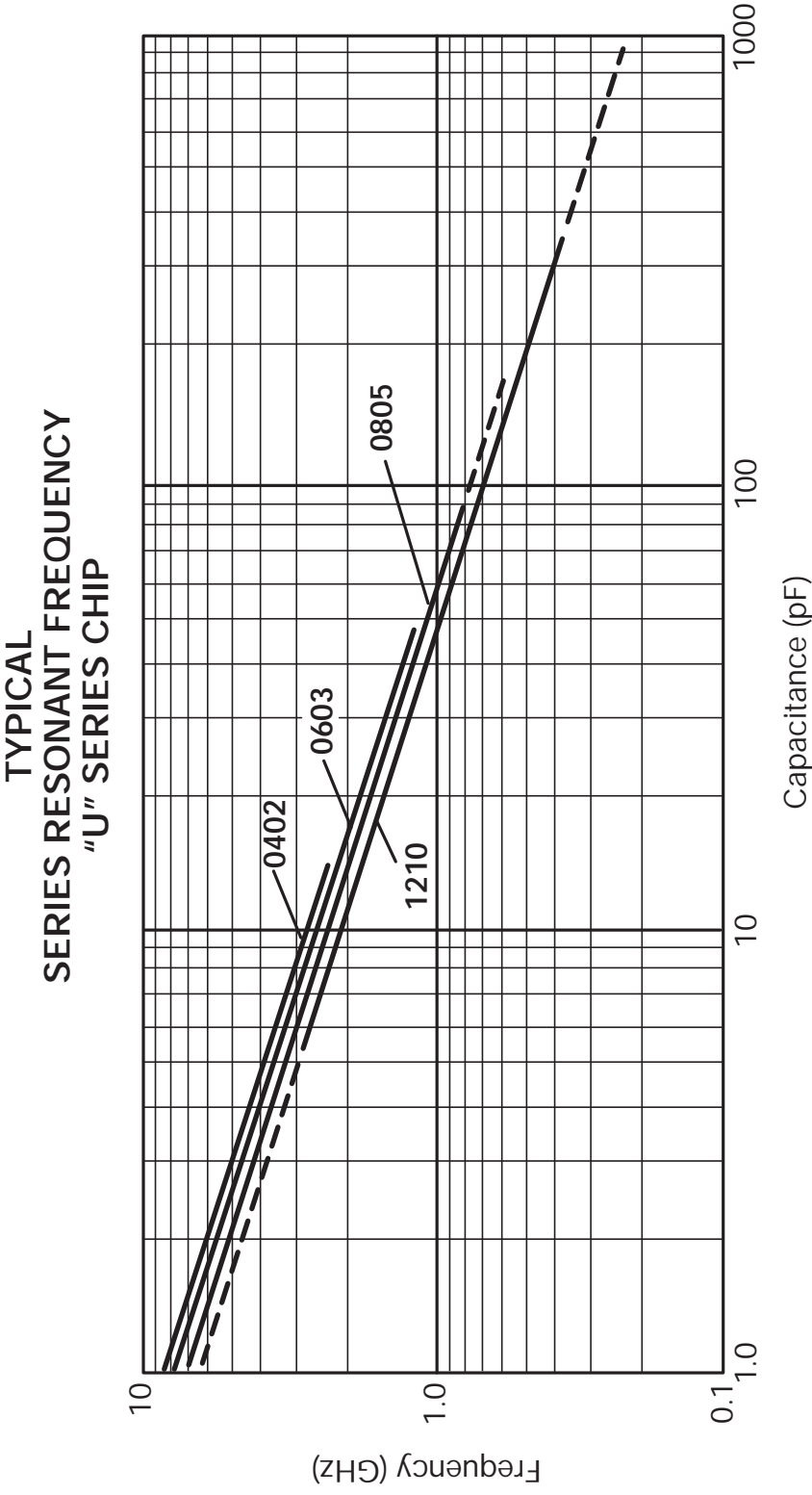

RF/Microwave C0G (NP0) Capacitors (Sn/Pb)

Ultra Low ESR, "U" Series, C0G (NP0) Chip Capacitors

GENERAL INFORMATION

"U" Series capacitors are C0G (NP0) chip capacitors specially designed for "Ultra" low ESR for applications in the communications market. Max ESR and effective capacitance

are met on each value producing lot to lot uniformity. Sizes available are EIA chip sizes 0402, 0603, 0805, and 1210.

DIMENSIONS: inches (millimeters)

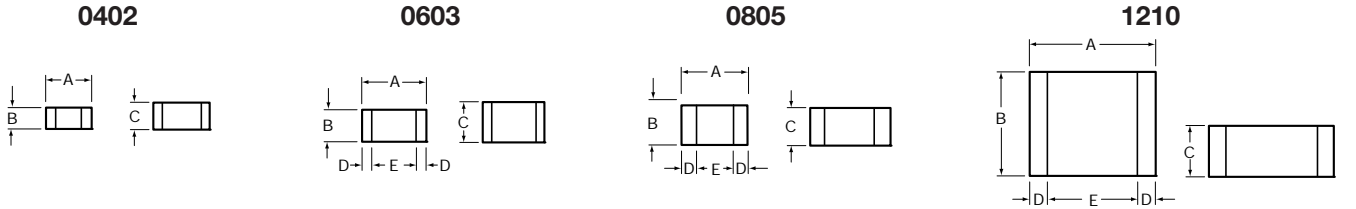

Size	A	B	C	D	E
0402	0.039±0.004 (1.00±0.1)	0.020±0.004 (0.50±0.1)	0.024 (0.6) max	N/A	N/A
0603	0.060±0.010 (1.52±0.25)	0.030±0.010 (0.76±0.25)	0.036 (0.91) max	0.010±0.005 (0.25±0.13)	0.030 (0.76) min
0805	0.079±0.008 (2.01±0.2)	0.049±0.008 (1.25±0.2)	0.040±0.005 (1.02±0.127)	0.020±0.010 (0.51±0.254)	0.020 (0.51) min
1210	0.126±0.008 (3.2±0.2)	0.098±0.008 (2.49±0.2)	0.050±0.005 (1.27±0.127)	0.025±0.015 (0.635±0.381)	0.040 (1.02) min

HOW TO ORDER

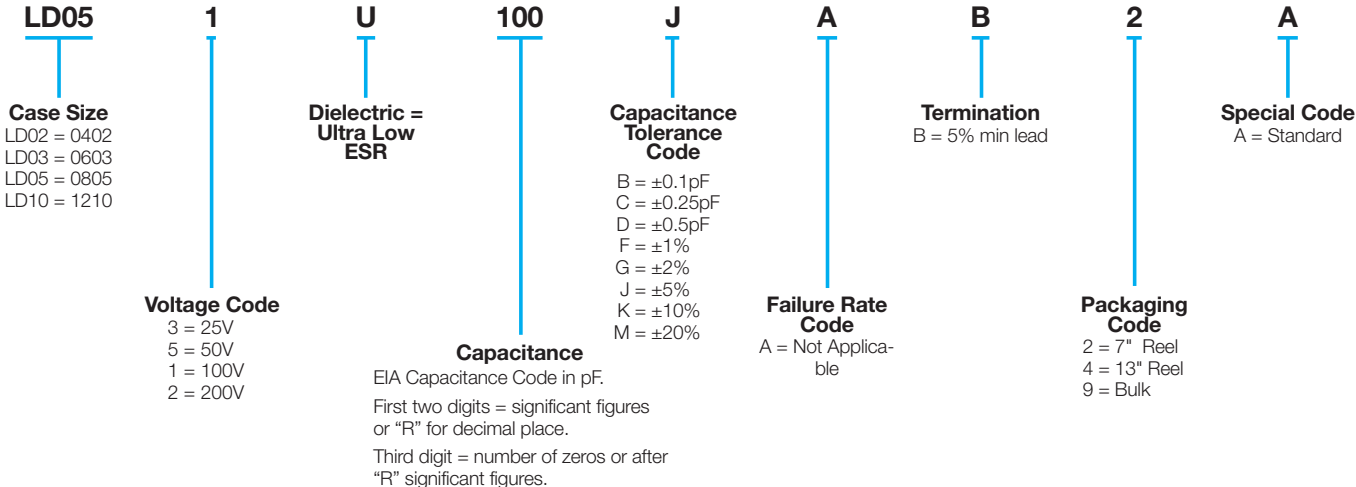

ELECTRICAL CHARACTERISTICS

Capacitance Values and Tolerances:

- Size 0402 - 0.2 pF to 22 pF @ 1 MHz
- Size 0603 - 1.0 pF to 100 pF @ 1 MHz
- Size 0805 - 1.6 pF to 160 pF @ 1 MHz
- Size 1210 - 2.4 pF to 1000 pF @ 1 MHz

Temperature Coefficient of Capacitance (TC):

0±30 ppm/°C (-55° to +125°C)

Insulation Resistance (IR):

- 10¹² Ω min. @ 25°C and rated WVDC
- 10¹¹ Ω min. @ 125°C and rated WVDC

Working Voltage (WVDC):

- Size Working Voltage
- 0402 - 50, 25 WVDC
- 0603 - 200, 100, 50 WVDC
- 0805 - 200, 100 WVDC
- 1210 - 200, 100 WVDC

Dielectric Working Voltage (DWV):

250% of rated WVDC

Equivalent Series Resistance Typical (ESR):

- 0402 - See Performance Curve, page 12
- 0603 - See Performance Curve, page 12
- 0805 - See Performance Curve, page 12
- 1210 - See Performance Curve, page 12

Marking: Laser marking EIA J marking standard (except 0603) (capacitance code and tolerance upon request).

MILITARY SPECIFICATIONS

Meets or exceeds the requirements of MIL-C-55681

Not RoHS Compliant

“U” SERIES KITS

0402

Kit 5000 UZ			
Cap. Value pF	Tolerance	Cap. Value pF	Tolerance
0.5	B ($\pm 0.1\text{pF}$)	4.7	B ($\pm 0.1\text{pF}$)
1.0		5.6	
1.5		6.8	
1.8		8.2	
2.2		10.0	
2.4	J ($\pm 5\%$)	12.0	J ($\pm 5\%$)
3.0		15.0	
3.6			

***25 each of 15 values

0603

Kit 4000 UZ			
Cap. Value pF	Tolerance	Cap. Value pF	Tolerance
1.0	B ($\pm 0.1\text{pF}$)	6.8	B ($\pm 0.1\text{pF}$)
1.2		7.5	
1.5		8.2	
1.8		10.0	
2.0		12.0	
2.4		15.0	
2.7		18.0	
3.0		22.0	
3.3		27.0	
3.9		33.0	
4.7	J ($\pm 5\%$)	39.0	J ($\pm 5\%$)
5.6		47.0	

***25 each of 24 values

0805

Kit 3000 UZ					
Cap. Value pF	Tolerance	Cap. Value pF	Tolerance		
1.0	B ($\pm 0.1\text{pF}$)	15.0	J ($\pm 5\%$)		
1.5		18.0			
2.2		22.0			
2.4		24.0			
2.7		27.0			
3.0		33.0			
3.3		36.0			
3.9		39.0			
4.7		47.0			
5.6		56.0			
7.5		68.0			
8.2		82.0			
9.1		100.0			
10.0		J ($\pm 5\%$)		130.0	J ($\pm 5\%$)
12.0				160.0	

***25 each of 30 values

1210

Kit 3500 UZ			
Cap. Value pF	Tolerance	Cap. Value pF	Tolerance
2.2	B ($\pm 0.1\text{pF}$)	36.0	J ($\pm 5\%$)
2.7		39.0	
4.7		47.0	
5.1		51.0	
6.8		56.0	
8.2		68.0	
9.1		82.0	
10.0		J ($\pm 5\%$)	
13.0	120.0		
15.0	130.0		
18.0	240.0		
20.0	300.0		
24.0	390.0		
27.0	470.0		
30.0	680.0		

***25 each of 30 values

X8R/X8L Dielectric



General Specifications

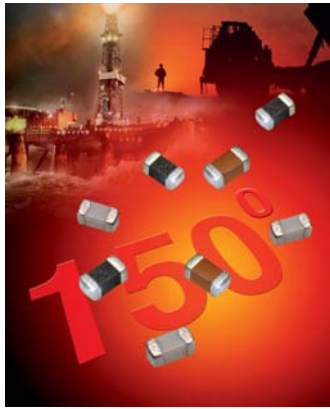

AVX has developed a range of multilayer ceramic capacitors designed for use in applications up to 150°C. These capacitors are manufactured with an X8R and an X8L dielectric material. X8R material has capacitance variation of ±15% between -55°C and +150°C. The X8L material has capacitance variation of ±15% between -55°C to 125°C and +15/-40% from +125°C to +150°C.

The need for X8R and X8L performance has been driven by customer requirements for parts that operate at elevated temperatures. They provide a highly reliable capacitor with low loss and stable capacitance over temperature.

They are ideal for automotive under the hood sensors, and various industrial applications. Typical industrial application would be drilling monitoring system. They can also be used as bulk capacitors for high temperature camera modules.

Both X8R and X8L dielectric capacitors are automotive AEC-Q200 qualified. Optional termination systems, tin, FLEXITERM® and conductive epoxy for hybrid applications are available. Providing this series with our FLEXITERM® termination system provides further advantage to customers by way of enhanced resistance to both, temperature cycling and mechanical damage.

PART NUMBER (see page 2 for complete part number explanation)

0805

Size
0603
0805
1206

5

Voltage
16V = Y
25V = 3
50V = 5
100V = 1

F

Dielectric
X8R = F
X8L = L

104

Capacitance Code (In pF)
2 Sig. Digits + Number of Zeros
e.g. 10µF = 106

K

Capacitance Tolerance
J = ± 5%
K = ± 10%
M = ± 20%

4

Failure Rate
4 = Automotive
A = Not Applicable

T

Terminations
T = Plated Ni and Sn
Z = FLEXITERM®
U = Conductive Epoxy for Hybrid apps

2

Packaging
2 = 7" Reel
4 = 13" Reel

A

Special Code
A = Std. Product

NOTE: Contact factory for availability of Termination and Tolerance Options for Specific Part Numbers.



X8R

SIZE	WVDC	0603		0805		1206	
		25V	50V	25V	50V	25V	50V
331	Cap 330	G	G	J	J		
471	470	G	G	J	J		
681	680	G	G	J	J		
102	1000	G	G	J	J	J	J
152	1500	G	G	J	J	J	J
222	2200	G	G	J	J	J	J
332	3300	G	G	J	J	J	J
472	4700	G	G	J	J	J	J
682	6800	G	G	J	J	J	J
103	Cap 0.01	G	G	J	J	J	J
153	0.015	G	G	J	J	J	J
223	0.022	G	G	J	J	J	J
333	0.033	G	G	J	J	J	J
473	0.047	G	G	J	J	J	J
683	0.068	G		N	N	M	M
104	0.1			N	N	M	M
154	0.15			N	N	M	M
224	0.22			N		M	M
334	0.33					M	M
474	0.47					M	
684	0.68						
105	1						
SIZE	WVDC	25V	50V	25V	50V	25V	50V

X8L

SIZE	WVDC	0603			0805			1206			
		25V	50V	100V	25V	50V	100V	16V	25V	50V	100V
331	Cap 330		G	G		J	J				
471	470		G	G		J	J				
681	680		G	G		J	J				
102	1000		G	G		J	J				
152	1500		G	G		J	J			J	J
222	2200		G	G		J	J			J	J
332	3300		G	G		J	J			J	J
472	4700		G	G		J	J			J	J
682	6800		G	G		J	J			J	J
103	Cap 0.01		G	G		J	J			J	J
153	0.015		G	G		J	J			J	J
223	0.022		G	G		J	J			J	J
333	0.033		G	G		J	J	N		J	J
473	0.047		G	G		J	J	N		J	J
683	0.068		G	G		J	J			J	J
104	0.1		G	G		J	J			J	M
154	0.15					J	N			J	Q
224	0.22					N	N			J	Q
334	0.33					N				J	Q
474	0.47					N				M	P
684	0.68									M	
105	1									M	
SIZE	WVDC	25V	50V	100V	25V	50V	100V	16V	25V	50V	100V

Letter	A	C	E	G	J	K	M	N	P	Q	X	Y	Z
Max. Thickness	0.33 (0.013)	0.56 (0.022)	0.71 (0.028)	0.90 (0.035)	0.94 (0.037)	1.02 (0.040)	1.27 (0.050)	1.40 (0.055)	1.52 (0.060)	1.78 (0.070)	2.29 (0.090)	2.54 (0.100)	2.79 (0.110)
	PAPER					EMBOSSED							

= AEC-Q200 Qualified



X8R/X8L Dielectric



General Specifications

APPLICATIONS FOR X8R AND X8L CAPACITORS

- All market sectors with a 150°C requirement
- Automotive on engine applications
- Oil exploration applications
- Hybrid automotive applications
 - Battery control
 - Inverter / converter circuits
 - Motor control applications
 - Water pump
- Hybrid commercial applications
 - Emergency circuits
 - Sensors
 - Temperature regulation

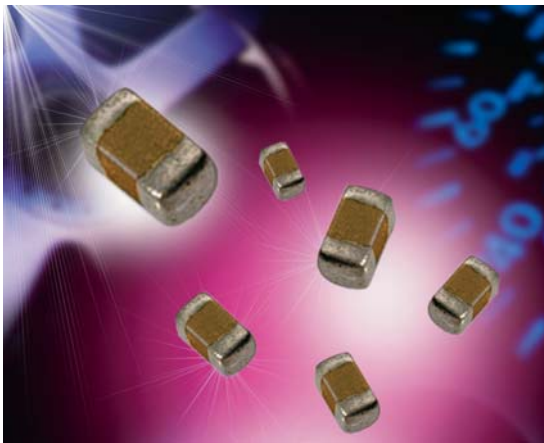

ADVANTAGES OF X8R AND X8L MLC CAPACITORS

- Both ranges are qualified to the highest automotive AEC-Q200 standards
- Excellent reliability compared to other capacitor technologies
- RoHS compliant
- Low ESR / ESL compared to other technologies
- Tin solder finish
- FLEXITERM® available
- Epoxy termination for hybrid available
- 100V range available

ENGINEERING TOOLS FOR HIGH VOLTAGE MLC CAPACITORS

- Samples
- Technical Articles
- Application Engineering
- Application Support

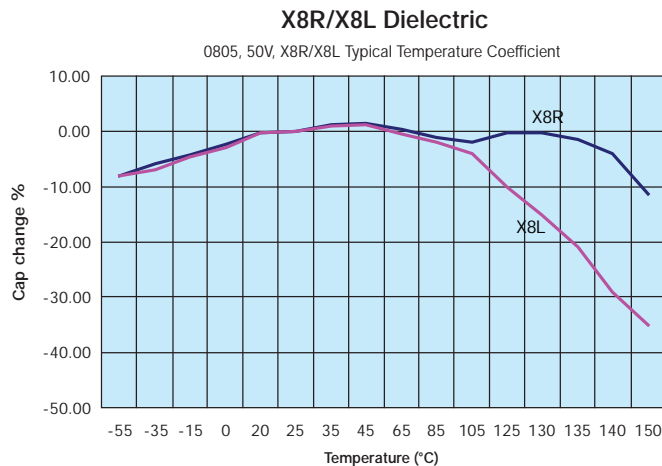

X8R/X8L Dielectric

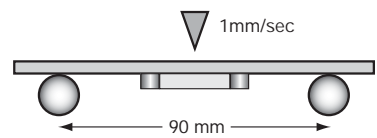

Specifications and Test Methods

Parameter/Test		X8R/X8L Specification Limits	Measuring Conditions	
Operating Temperature Range		-55°C to +150°C	Temperature Cycle Chamber	
Capacitance		Within specified tolerance	Freq.: 1.0 kHz ± 10%	
Dissipation Factor		≤ 2.5% for ≥ 50V DC rating ≤ 3.5% for 25V DC and 16V DC rating	Voltage: 1.0Vrms ± .2V	
Insulation Resistance		100,000MΩ or 1000MΩ - μF, whichever is less	Charge device with rated voltage for 120 ± 5 secs @ room temp/humidity	
Dielectric Strength		No breakdown or visual defects	Charge device with 300% of rated voltage for 1-5 seconds, w/charge and discharge current limited to 50 mA (max) Note: Charge device with 150% of rated voltage for 500V devices.	
Resistance to Flexure Stresses	Appearance	No defects	Deflection: 2mm Test Time: 30 seconds 	
	Capacitance Variation	≤ ±12%		
	Dissipation Factor	Meets Initial Values (As Above)		
	Insulation Resistance	≥ Initial Value x 0.3		
Solderability		≥ 95% of each terminal should be covered with fresh solder	Dip device in eutectic solder at 230 ± 5°C for 5.0 ± 0.5 seconds	
Resistance to Solder Heat	Appearance	No defects, <25% leaching of either end terminal	Dip device in eutectic solder at 260°C for 60 seconds. Store at room temperature for 24 ± 2 hours before measuring electrical properties.	
	Capacitance Variation	≤ ±7.5%		
	Dissipation Factor	Meets Initial Values (As Above)		
	Insulation Resistance	Meets Initial Values (As Above)		
	Dielectric Strength	Meets Initial Values (As Above)		
Thermal Shock	Appearance	No visual defects	Step 1: -55°C ± 2°	30 ± 3 minutes
	Capacitance Variation	≤ ±7.5%	Step 2: Room Temp	≤ 3 minutes
	Dissipation Factor	Meets Initial Values (As Above)	Step 3: +125°C ± 2°	30 ± 3 minutes
	Insulation Resistance	Meets Initial Values (As Above)	Step 4: Room Temp	≤ 3 minutes
	Dielectric Strength	Meets Initial Values (As Above)	Repeat for 5 cycles and measure after 24 ± 2 hours at room temperature	
Load Life	Appearance	No visual defects	Charge device with 1.5 rated voltage (≤ 10V) in test chamber set at 150°C ± 2°C for 1000 hours (+48, -0) Remove from test chamber and stabilize at room temperature for 24 ± 2 hours before measuring.	
	Capacitance Variation	≤ ±12.5%		
	Dissipation Factor	≤ Initial Value x 2.0 (See Above)		
	Insulation Resistance	≥ Initial Value x 0.3 (See Above)		
	Dielectric Strength	Meets Initial Values (As Above)		
Load Humidity	Appearance	No visual defects	Store in a test chamber set at 85°C ± 2°C/ 85% ± 5% relative humidity for 1000 hours (+48, -0) with rated voltage applied. Remove from chamber and stabilize at room temperature and humidity for 24 ± 2 hours before measuring.	
	Capacitance Variation	≤ ±12.5%		
	Dissipation Factor	≤ Initial Value x 2.0 (See Above)		
	Insulation Resistance	≥ Initial Value x 0.3 (See Above)		
	Dielectric Strength	Meets Initial Values (As Above)		

X7R Dielectric

General Specifications



X7R formulations are called “temperature stable” ceramics and fall into EIA Class II materials. X7R is the most popular of these intermediate dielectric constant materials. Its temperature variation of capacitance is within $\pm 15\%$ from -55°C to $+125^{\circ}\text{C}$. This capacitance change is non-linear.

Capacitance for X7R varies under the influence of electrical operating conditions such as voltage and frequency.

X7R dielectric chip usage covers the broad spectrum of industrial applications where known changes in capacitance due to applied voltages are acceptable.



PART NUMBER (see page 2 for complete part number explanation)

0805	5	C	103	M	A	T	2	A
Size (L" x W")	Voltage 4V = 4 6.3V = 6 10V = Z 16V = Y 25V = 3 50V = 5 100V = 1 200V = 2 500V = 7	Dielectric X7R = C	Capacitance Code (In pF) 2 Sig. Digits + Number of Zeros	Capacitance Tolerance J = $\pm 5\%$ * K = $\pm 10\%$ M = $\pm 20\%$	Failure Rate A = Not Applicable	Terminations T = Plated Ni and Sn 7 = Gold Plated* Z = FLEXITERM®**	Packaging 2 = 7" Reel 4 = 13" Reel 7 = Bulk Cass. 9 = Bulk	Special Code A = Std. Product
				* $\leq 1\mu\text{F}$ only, contact factory for additional values		*Optional termination		Contact Factory For Multiples
						**See FLEXITERM® X7R section		

NOTE: Contact factory for availability of Termination and Tolerance Options for Specific Part Numbers.
Contact factory for non-specified capacitance values.

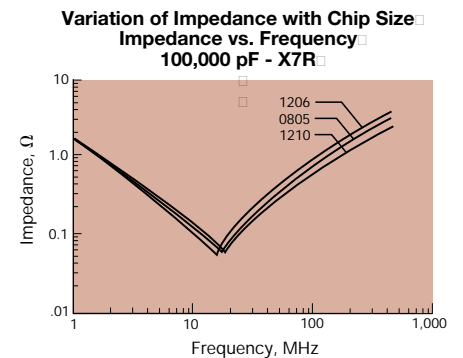
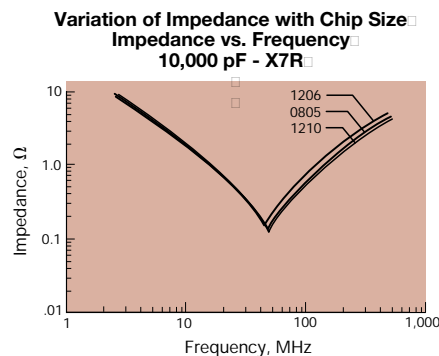
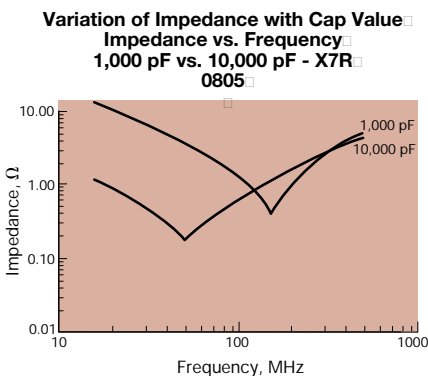
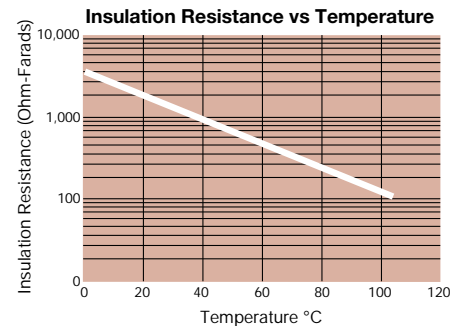
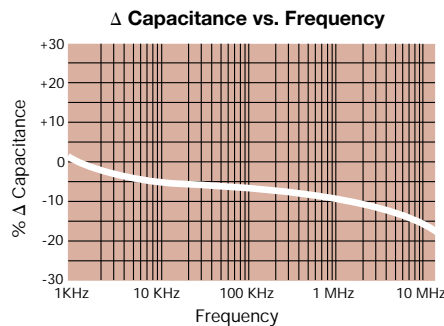
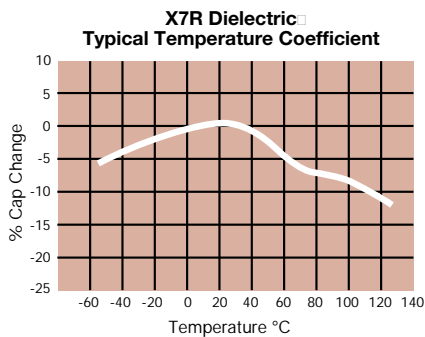

Specifications and Test Methods

Parameter/Test		X7R Specification Limits	Measuring Conditions	
Operating Temperature Range		-55°C to +125°C	Temperature Cycle Chamber	
Capacitance		Within specified tolerance	Freq.: 1.0 kHz \pm 10% Voltage: 1.0Vrms \pm .2V	
Dissipation Factor		\leq 2.5% for \geq 50V DC rating \leq 3.0% for 25V DC rating \leq 3.5% for 25V and 16V DC rating \leq 5.0% for \leq 10V DC rating		
Insulation Resistance		100,000M Ω or 1000M Ω - μ F, whichever is less	Charge device with rated voltage for 120 \pm 5 secs @ room temp/humidity	
Dielectric Strength		No breakdown or visual defects	Charge device with 300% of rated voltage for 1-5 seconds, w/charge and discharge current limited to 50 mA (max) Note: Charge device with 150% of rated voltage for 500V devices.	
Resistance to Flexure Stresses	Appearance	No defects	Deflection: 2mm Test Time: 30 seconds 	
	Capacitance Variation	\leq \pm 12%		
	Dissipation Factor	Meets Initial Values (As Above)		
	Insulation Resistance	\geq Initial Value x 0.3		
Solderability		\geq 95% of each terminal should be covered with fresh solder	Dip device in eutectic solder at 230 \pm 5°C for 5.0 \pm 0.5 seconds	
Resistance to Solder Heat	Appearance	No defects, <25% leaching of either end terminal	Dip device in eutectic solder at 260°C for 60 seconds. Store at room temperature for 24 \pm 2 hours before measuring electrical properties.	
	Capacitance Variation	\leq \pm 7.5%		
	Dissipation Factor	Meets Initial Values (As Above)		
	Insulation Resistance	Meets Initial Values (As Above)		
	Dielectric Strength	Meets Initial Values (As Above)		
Thermal Shock	Appearance	No visual defects	Step 1: -55°C \pm 2°	30 \pm 3 minutes
	Capacitance Variation	\leq \pm 7.5%	Step 2: Room Temp	\leq 3 minutes
	Dissipation Factor	Meets Initial Values (As Above)	Step 3: +125°C \pm 2°	30 \pm 3 minutes
	Insulation Resistance	Meets Initial Values (As Above)	Step 4: Room Temp	\leq 3 minutes
	Dielectric Strength	Meets Initial Values (As Above)	Repeat for 5 cycles and measure after 24 \pm 2 hours at room temperature	
Load Life	Appearance	No visual defects	Charge device with 1.5 rated voltage (\leq 10V) in test chamber set at 125°C \pm 2°C for 1000 hours (+48, -0) Remove from test chamber and stabilize at room temperature for 24 \pm 2 hours before measuring.	
	Capacitance Variation	\leq \pm 12.5%		
	Dissipation Factor	\leq Initial Value x 2.0 (See Above)		
	Insulation Resistance	\geq Initial Value x 0.3 (See Above)		
	Dielectric Strength	Meets Initial Values (As Above)		
Load Humidity	Appearance	No visual defects	Store in a test chamber set at 85°C \pm 2°C/ 85% \pm 5% relative humidity for 1000 hours (+48, -0) with rated voltage applied. Remove from chamber and stabilize at room temperature and humidity for 24 \pm 2 hours before measuring.	
	Capacitance Variation	\leq \pm 12.5%		
	Dissipation Factor	\leq Initial Value x 2.0 (See Above)		
	Insulation Resistance	\geq Initial Value x 0.3 (See Above)		
	Dielectric Strength	Meets Initial Values (As Above)		

X7R Dielectric



Capacitance Range

PREFERRED SIZES ARE SHADED

SIZE	1210							1812				1825		2220				2225		
	Reflow Only							Reflow Only				Reflow Only		Reflow Only				Reflow Only		
Soldering	Paper/Embossed							All Embossed				All Embossed		All Embossed				All Embossed		
Packaging	Paper/Embossed							All Embossed				All Embossed		All Embossed				All Embossed		
(L) Length (mm (in.))	3.20 ± 0.20 (0.126 ± 0.008)							4.50 ± 0.30 (0.177 ± 0.012)				4.50 ± 0.30 (0.177 ± 0.012)		5.70 ± 0.40 (0.225 ± 0.016)				5.72 ± 0.25 (0.225 ± 0.010)		
(W) Width (mm (in.))	2.50 ± 0.20 (0.098 ± 0.008)							3.20 ± 0.20 (0.126 ± 0.008)				6.40 ± 0.40 (0.252 ± 0.016)		5.00 ± 0.40 (0.197 ± 0.016)				6.35 ± 0.25 (0.250 ± 0.010)		
(t) Terminal (mm (in.))	0.50 ± 0.25 (0.020 ± 0.010)							0.61 ± 0.36 (0.024 ± 0.014)				0.61 ± 0.36 (0.024 ± 0.014)		0.64 ± 0.39 (0.025 ± 0.015)				0.64 ± 0.39 (0.025 ± 0.015)		
WVDC	10	16	25	50	100	200	500	50	100	200	500	50	100	25	50	100	200	50	100	
Cap (pF)	100																			
	150																			
	220																			
	330																			
	470																			
	680																			
	1000																			
	1500	J	J	J	J	J	J	M												
	2200	J	J	J	J	J	J	M												
	3300	J	J	J	J	J	J	M												
	4700	J	J	J	J	J	J	M												
	6800	J	J	J	J	J	J	M												
Cap (µF)	0.010	J	J	J	J	J	J	M	K	K	K	K	M	M		X	X	X	M	P
	0.015	J	J	J	J	J	J	P	K	K	K	P	M	M		X	X	X	M	P
	0.022	J	J	J	J	J	J	Q	K	K	K	P	M	M		X	X	X	M	P
	0.033	J	J	J	J	J	J	Q	K	K	K	X	M	M		X	X	X	M	P
	0.047	J	J	J	J	J	J		K	K	K	Z	M	M		X	X	X	M	P
	0.068	J	J	J	J	J	M		K	K	K	Z	M	M		X	X	X	M	P
	0.10	J	J	J	J	J	M		K	K	K	Z	M	M		X	X	X	M	P
	0.15	J	J	J	J	M	Z		K	K	P		M	M		X	X	X	M	P
	0.22	J	J	J	J	P	Z		K	K	P		M	M		X	X	X	M	P
	0.33	J	J	J	J	Q			K	M	X		M	M		X	X	X	M	P
	0.47	M	M	M	M	Q			K	P			M	M		X	X	X	M	P
	0.68	M	M	P	X	X			M	Q			M	P		X	X		M	P
	1.0	N	N	P	X	Z			M	X			M	P		X	X		M	P
	1.5	N	N	Z	Z	Z			Z	Z			M			X	X		M	X
	2.2	X	X	Z	Z	Z			Z	Z						X	X		M	
	3.3	X	X	Z	Z				Z							X	Z			
	4.7	X	X	Z	Z				Z							X	Z			
	10	Z	Z	Z*												Z				
	22	Z*	Z*																	
	47																			
	100																			
WVDC	10	16	25	50	100	200	500	50	100	200	500	50	100	25	50	100	200	50	100	

Letter	A	C	E	G	J	K	M	N	P	Q	X	Y	Z
Max. Thickness	0.33 (0.013)	0.56 (0.022)	0.71 (0.028)	0.90 (0.035)	0.94 (0.037)	1.02 (0.040)	1.27 (0.050)	1.40 (0.055)	1.52 (0.060)	1.78 (0.070)	2.29 (0.090)	2.54 (0.100)	2.79 (0.110)
	PAPER					EMBOSSSED							

*Optional Specifications – Contact factory



X7S Dielectric



General Specifications

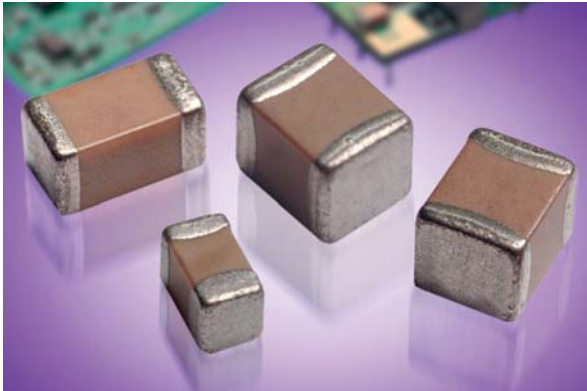

GENERAL DESCRIPTION

X7S formulations are called “temperature stable” ceramics and fall into EIA Class II materials. Its temperature variation of capacitance is within $\pm 22\%$ from -55°C to $+125^{\circ}\text{C}$. This capacitance change is non-linear.

Capacitance for X7S varies under the influence of electrical operating conditions such as voltage and frequency.

X7S dielectric chip usage covers the broad spectrum of industrial applications where known changes in capacitance due to applied voltages are acceptable.

PART NUMBER (see page 2 for complete part number explanation)

1206

Size
(L" x W")

Z

Voltage
4 = 4V
6 = 6.3V
Z = 10V
Y = 16V
3 = 25V
5 = 50V
1 = 100V
2 = 200V

Z

Dielectric
Z = X7S

105

Capacitance Code (In pF)
2 Sig. Digits + Number of Zeros

M

Capacitance Tolerance
K = $\pm 10\%$
M = $\pm 20\%$

A

Failure Rate
A = N/A

T

Terminations
T = Plated Ni and Sn

2

Packaging
2 = 7" Reel
4 = 13" Reel
7 = Bulk Cass.

A

Special Code
A = Std. Product

NOTE: Contact factory for availability of Tolerance Options for Specific Part Numbers.



TYPICAL ELECTRICAL CHARACTERISTICS

X7S Dielectric
Typical Temperature Coefficient

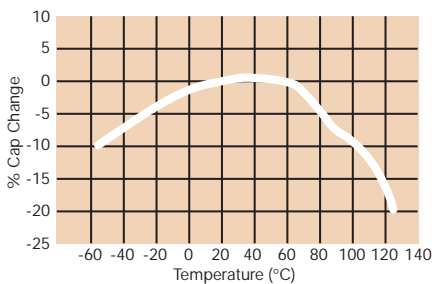

Δ Capacitance vs. Frequency

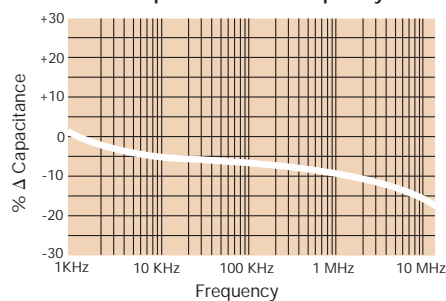

Insulation Resistance vs Temperature

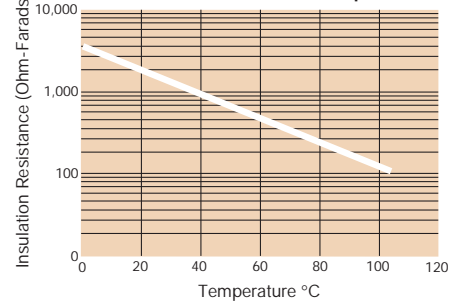

Variation of Impedance with Cap Value
Impedance vs. Frequency
1,000 pF vs. 10,000 pF - X7S
0805

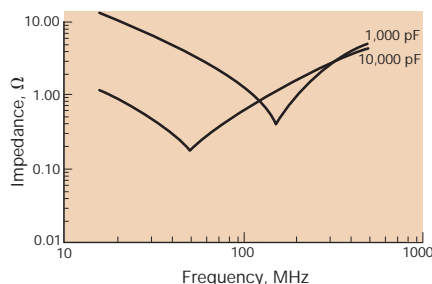

Variation of Impedance with Chip Size
Impedance vs. Frequency
10,000 pF - X7S

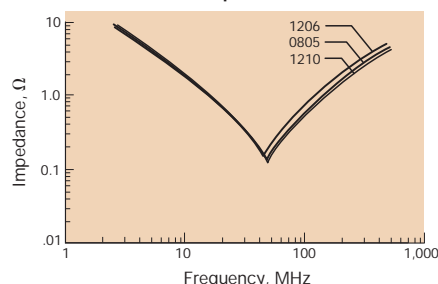

Variation of Impedance with Chip Size
Impedance vs. Frequency
100,000 pF - X7S

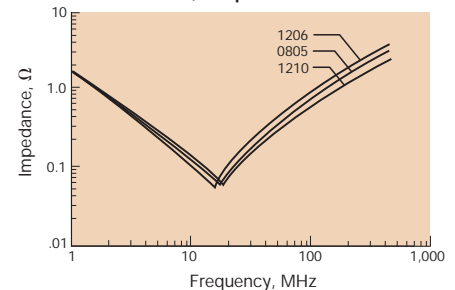

Specifications and Test Methods

Parameter/Test		X7S Specification Limits	Measuring Conditions	
Operating Temperature Range		-55°C to +125°C	Temperature Cycle Chamber	
Capacitance		Within specified tolerance	Freq.: 1.0 kHz ± 10% Voltage: 1.0Vrms ± .2V For Cap > 10 µF, 0.5Vrms @ 120Hz	
Dissipation Factor		≤ 2.5% for ≥ 50V DC rating ≤ 3.0% for 25V DC rating ≤ 3.5% for 16V DC rating ≤ 5.0% for ≤ 10V DC rating		
Insulation Resistance		100,000MΩ or 1000MΩ - µF, whichever is less	Charge device with rated voltage for 120 ± 5 secs @ room temp/humidity	
Dielectric Strength		No breakdown or visual defects	Charge device with 300% of rated voltage for 1-5 seconds, w/charge and discharge current limited to 50 mA (max)	
Resistance to Flexure Stresses	Appearance	No defects	Deflection: 2mm Test Time: 30 seconds 	
	Capacitance Variation	≤ ±12%		
	Dissipation Factor	Meets Initial Values (As Above)		
	Insulation Resistance	≥ Initial Value x 0.3		
Solderability		≥ 95% of each terminal should be covered with fresh solder	Dip device in eutectic solder at 230 ± 5°C for 5.0 ± 0.5 seconds	
Resistance to Solder Heat	Appearance	No defects, <25% leaching of either end terminal	Dip device in eutectic solder at 260°C for 60 seconds. Store at room temperature for 24 ± 2 hours before measuring electrical properties.	
	Capacitance Variation	≤ ±7.5%		
	Dissipation Factor	Meets Initial Values (As Above)		
	Insulation Resistance	Meets Initial Values (As Above)		
	Dielectric Strength	Meets Initial Values (As Above)		
Thermal Shock	Appearance	No visual defects	Step 1: -55°C ± 2°	30 ± 3 minutes
	Capacitance Variation	≤ ±7.5%	Step 2: Room Temp	≤ 3 minutes
	Dissipation Factor	Meets Initial Values (As Above)	Step 3: +125°C ± 2°	30 ± 3 minutes
	Insulation Resistance	Meets Initial Values (As Above)	Step 4: Room Temp	≤ 3 minutes
	Dielectric Strength	Meets Initial Values (As Above)	Repeat for 5 cycles and measure after 24 ± 2 hours at room temperature	
Load Life	Appearance	No visual defects	Charge device with 1.5 rated voltage (≤ 10V) in test chamber set at 125°C ± 2°C for 1000 hours (+48, -0) Remove from test chamber and stabilize at room temperature for 24 ± 2 hours before measuring.	
	Capacitance Variation	≤ ±12.5%		
	Dissipation Factor	≤ Initial Value x 2.0 (See Above)		
	Insulation Resistance	≥ Initial Value x 0.3 (See Above)		
	Dielectric Strength	Meets Initial Values (As Above)		
Load Humidity	Appearance	No visual defects	Store in a test chamber set at 85°C ± 2°C/ 85% ± 5% relative humidity for 1000 hours (+48, -0) with rated voltage applied. Remove from chamber and stabilize at room temperature and humidity for 24 ± 2 hours before measuring.	
	Capacitance Variation	≤ ±12.5%		
	Dissipation Factor	≤ Initial Value x 2.0 (See Above)		
	Insulation Resistance	≥ Initial Value x 0.3 (See Above)		
	Dielectric Strength	Meets Initial Values (As Above)		

X5R Dielectric

General Specifications

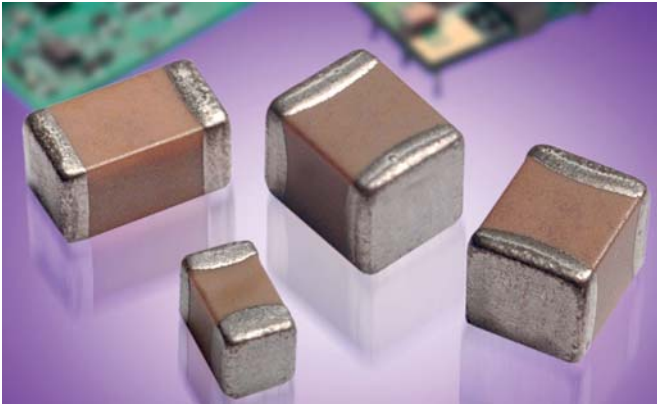

GENERAL DESCRIPTION

- General Purpose Dielectric for Ceramic Capacitors
- EIA Class II Dielectric
- Temperature variation of capacitance is within $\pm 15\%$ from -55°C to $+85^{\circ}\text{C}$
- Well suited for decoupling and filtering applications
- Available in High Capacitance values (up to $100\mu\text{F}$)

PART NUMBER (see page 2 for complete part number explanation)

1210

Size
(L" x W")

4

Voltage
4 = 4V
6 = 6.3V
Z = 10V
Y = 16V
3 = 25V
D = 35V
5 = 50V

D

Dielectric
D = X5R

107

Capacitance Code (In pF)
2 Sig. Digits + Number of Zeros

M

Capacitance Tolerance
K = $\pm 10\%$
M = $\pm 20\%$

A

Failure Rate
A = N/A

T

Terminations
T = Plated Ni and Sn

2

Packaging
2 = 7" Reel
4 = 13" Reel
7 = Bulk Cass.
9 = Bulk
U = 4mm TR (01005)

A

Special Code
A = Std.

NOTE: Contact factory for availability of Tolerance Options for Specific Part Numbers. Contact factory for non-specified capacitance values.



TYPICAL ELECTRICAL CHARACTERISTICS

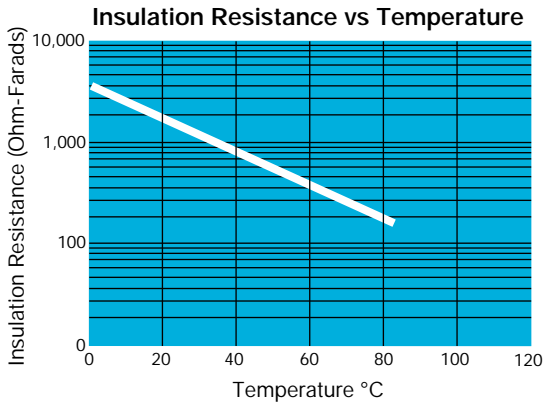
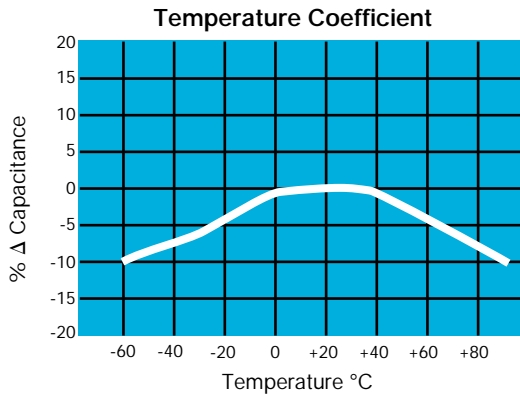

X5R Dielectric



Specifications and Test Methods

Parameter/Test		X5R Specification Limits	Measuring Conditions	
Operating Temperature Range		-55°C to +85°C	Temperature Cycle Chamber	
Capacitance		Within specified tolerance	Freq.: 1.0 kHz \pm 10% Voltage: 1.0Vrms \pm .2V For Cap > 10 μ F, 0.5Vrms @ 120Hz	
Dissipation Factor		\leq 2.5% for \geq 50V DC rating \leq 3.0% for 25V DC rating \leq 12.5% Max. for 16V DC rating and lower Contact Factory for DF by PN		
Insulation Resistance		10,000M Ω or 500M Ω - μ F, whichever is less	Charge device with rated voltage for 120 \pm 5 secs @ room temp/humidity	
Dielectric Strength		No breakdown or visual defects	Charge device with 300% of rated voltage for 1-5 seconds, w/charge and discharge current limited to 50 mA (max)	
Resistance to Flexure Stresses	Appearance	No defects	Deflection: 2mm Test Time: 30 seconds 	
	Capacitance Variation	\leq \pm 12%		
	Dissipation Factor	Meets Initial Values (As Above)		
	Insulation Resistance	\geq Initial Value x 0.3		
Solderability		\geq 95% of each terminal should be covered with fresh solder	Dip device in eutectic solder at 230 \pm 5°C for 5.0 \pm 0.5 seconds	
Resistance to Solder Heat	Appearance	No defects, <25% leaching of either end terminal	Dip device in eutectic solder at 260°C for 60 seconds. Store at room temperature for 24 \pm 2 hours before measuring electrical properties.	
	Capacitance Variation	\leq \pm 7.5%		
	Dissipation Factor	Meets Initial Values (As Above)		
	Insulation Resistance	Meets Initial Values (As Above)		
	Dielectric Strength	Meets Initial Values (As Above)		
Thermal Shock	Appearance	No visual defects	Step 1: -55°C \pm 2°	30 \pm 3 minutes
	Capacitance Variation	\leq \pm 7.5%	Step 2: Room Temp	\leq 3 minutes
	Dissipation Factor	Meets Initial Values (As Above)	Step 3: +85°C \pm 2°	30 \pm 3 minutes
	Insulation Resistance	Meets Initial Values (As Above)	Step 4: Room Temp	\leq 3 minutes
	Dielectric Strength	Meets Initial Values (As Above)	Repeat for 5 cycles and measure after 24 \pm 2 hours at room temperature	
	Load Life		No visual defects	Charge device with 1.5X rated voltage in test chamber set at 85°C \pm 2°C for 1000 hours (+48, -0). Note: Contact factory for *optional specification part numbers that are tested at < 1.5X rated voltage.
Load Humidity	Capacitance Variation	\leq \pm 12.5%	Remove from test chamber and stabilize at room temperature for 24 \pm 2 hours before measuring.	
	Dissipation Factor	\leq Initial Value x 2.0 (See Above)		
	Insulation Resistance	\geq Initial Value x 0.3 (See Above)		
	Dielectric Strength	Meets Initial Values (As Above)		
	Appearance	No visual defects		
Load Humidity	Capacitance Variation	\leq \pm 12.5%	Store in a test chamber set at 85°C \pm 2°C/ 85% \pm 5% relative humidity for 1000 hours (+48, -0) with rated voltage applied.	
	Dissipation Factor	\leq Initial Value x 2.0 (See Above)		
	Insulation Resistance	\geq Initial Value x 0.3 (See Above)		
	Dielectric Strength	Meets Initial Values (As Above)		
	Appearance	No visual defects		
Load Humidity		No visual defects	Remove from chamber and stabilize at room temperature and humidity for 24 \pm 2 hours before measuring.	
Load Humidity	Capacitance Variation	\leq \pm 12.5%	Store in a test chamber set at 85°C \pm 2°C/ 85% \pm 5% relative humidity for 1000 hours (+48, -0) with rated voltage applied.	
	Dissipation Factor	\leq Initial Value x 2.0 (See Above)		
	Insulation Resistance	\geq Initial Value x 0.3 (See Above)		
	Dielectric Strength	Meets Initial Values (As Above)		
	Appearance	No visual defects		

Y5V Dielectric

General Specifications

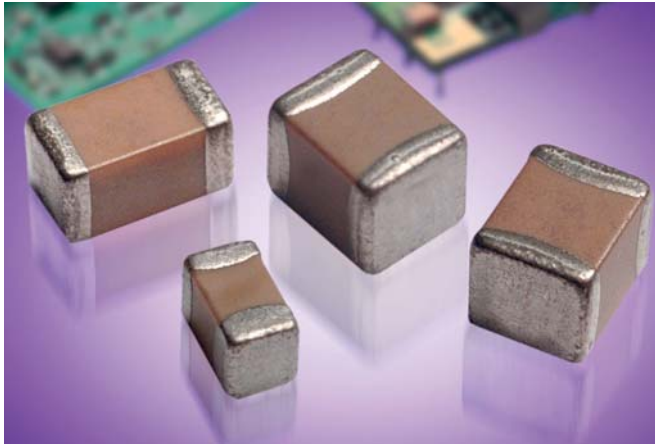

Y5V formulations are for general-purpose use in a limited temperature range. They have a wide temperature characteristic of +22% -82% capacitance change over the operating temperature range of -30°C to +85°C.

These characteristics make Y5V ideal for decoupling applications within limited temperature range.



PART NUMBER (see page 2 for complete part number explanation)

0805

Size
(L" x W")

3

Voltage
6.3V = 6
10V = Z
16V = Y
25V = 3
50V = 5

G

Dielectric
Y5V = G

104

Capacitance Code (In pF)
2 Sig. Digits + Number of Zeros

Z

Capacitance Tolerance
Z = +80 -20%

A

Failure Rate
A = Not Applicable

T

Terminations
T = Plated Ni and Sn

2

Packaging
2 = 7" Reel
4 = 13" Reel

A

Special Code
A = Std. Product

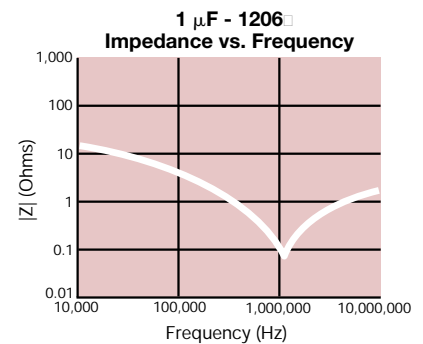
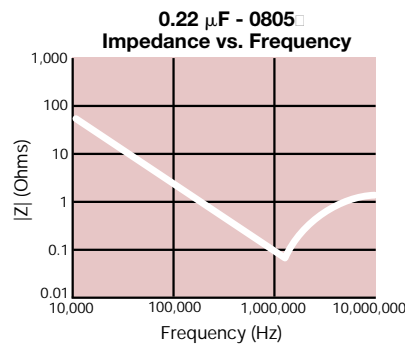
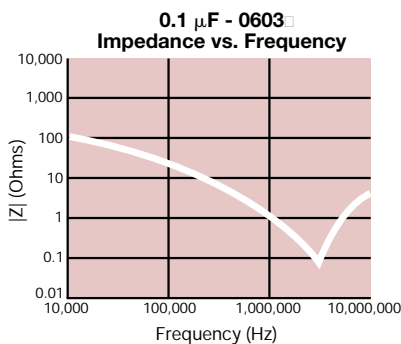
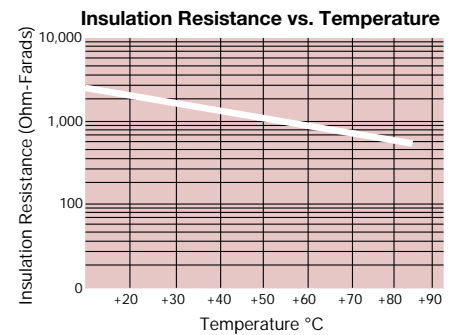
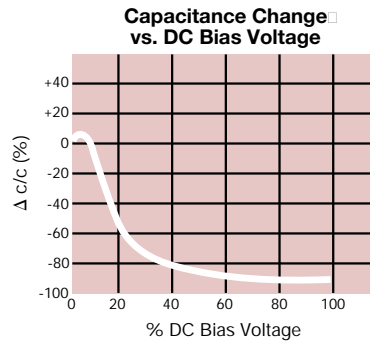
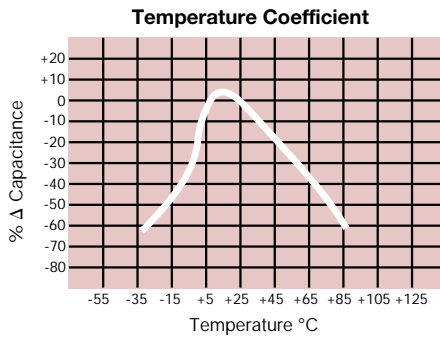

Y5V Dielectric

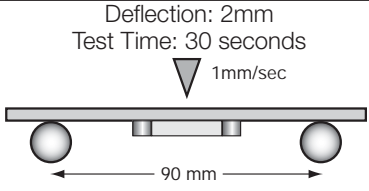

Specifications and Test Methods

Parameter/Test		Y5V Specification Limits	Measuring Conditions	
Operating Temperature Range		-30°C to +85°C	Temperature Cycle Chamber	
Capacitance		Within specified tolerance	Freq.: 1.0 kHz \pm 10% Voltage: 1.0Vrms \pm .2V For Cap > 10 μ F, 0.5Vrms @ 120Hz	
Dissipation Factor		\leq 5.0% for \geq 50V DC rating \leq 7.0% for 25V DC rating \leq 9.0% for 16V DC rating \leq 12.5% for \leq 10V DC rating		
Insulation Resistance		10,000M Ω or 500M Ω - μ F, whichever is less	Charge device with rated voltage for 120 \pm 5 secs @ room temp/humidity	
Dielectric Strength		No breakdown or visual defects	Charge device with 300% of rated voltage for 1-5 seconds, w/charge and discharge current limited to 50 mA (max)	
Resistance to Flexure Stresses	Appearance	No defects	Deflection: 2mm Test Time: 30 seconds 	
	Capacitance Variation	\leq \pm 30%		
	Dissipation Factor	Meets Initial Values (As Above)		
	Insulation Resistance	\geq Initial Value x 0.1		
Solderability		\geq 95% of each terminal should be covered with fresh solder	Dip device in eutectic solder at 230 \pm 5°C for 5.0 \pm 0.5 seconds	
Resistance to Solder Heat	Appearance	No defects, <25% leaching of either end terminal	Dip device in eutectic solder at 260°C for 60 seconds. Store at room temperature for 24 \pm 2 hours before measuring electrical properties.	
	Capacitance Variation	\leq \pm 20%		
	Dissipation Factor	Meets Initial Values (As Above)		
	Insulation Resistance	Meets Initial Values (As Above)		
	Dielectric Strength	Meets Initial Values (As Above)		
Thermal Shock	Appearance	No visual defects	Step 1: -30°C \pm 2°	30 \pm 3 minutes
	Capacitance Variation	\leq \pm 20%	Step 2: Room Temp	\leq 3 minutes
	Dissipation Factor	Meets Initial Values (As Above)	Step 3: +85°C \pm 2°	30 \pm 3 minutes
	Insulation Resistance	Meets Initial Values (As Above)	Step 4: Room Temp	\leq 3 minutes
	Dielectric Strength	Meets Initial Values (As Above)	Repeat for 5 cycles and measure after 24 \pm 2 hours at room temperature	
	Load Life		No visual defects	Charge device with twice rated voltage in test chamber set at 85°C \pm 2°C for 1000 hours (+48, -0)
Load Humidity	Appearance	No visual defects	Remove from test chamber and stabilize at room temperature for 24 \pm 2 hours before measuring.	
	Capacitance Variation	\leq \pm 30%		
	Dissipation Factor	\leq Initial Value x 1.5 (See Above)		
	Insulation Resistance	\geq Initial Value x 0.1 (See Above)		
	Dielectric Strength	Meets Initial Values (As Above)		
Load Humidity	Appearance	No visual defects	Store in a test chamber set at 85°C \pm 2°C/ 85% \pm 5% relative humidity for 1000 hours (+48, -0) with rated voltage applied.	
	Capacitance Variation	\leq \pm 30%		
	Dissipation Factor	\leq Initial Value x 1.5 (See above)		
	Insulation Resistance	\geq Initial Value x 0.1 (See Above)		
	Dielectric Strength	Meets Initial Values (As Above)		

MLCC Gold Termination – AU Series



General Specifications



AVX Corporation will support those customers for commercial and military Multilayer Ceramic Capacitors with a termination consisting of Gold. This termination is indicated by the use of a “7” or “G” in the 12th position of the AVX Catalog Part Number. This fulfills AVX’s commitment to providing a full range of products to our customers. Please contact the factory if you require additional information on our MLCC Gold Termination.



PART NUMBER

AU03	Y	C	104	K	A	7	2	A
Size	Voltage	Dielectric	Capacitance Code (In pF)	Capacitance Tolerance	Failure Rate	Terminations	Packaging	Special Code
AU01 - 0201 AU02 - 0402 AU03 - 0603 AU05 - 0805 AU06 - 1206 AU10 - 1210 AU12 - 1812 AU13 - 1825 AU14 - 2225 AU16 - 0306 AU17 - 0508 AU18 - 0612	6.3V = 6 10V = Z 16V = Y 25V = 3 35V = D 50V = 5 100V = 1 200V = 2 500V = 7	COG (NP0) = A X7R = C X5R = D	2 Sig. Digits + Number of Zeros	B = ±.10 pF (<10pF) C = ±.25 pF (<10pF) D = ±.50 pF (<10pF) F = ±1% (≥ 10 pF) G = ±2% (≥ 10 pF) J = ±5% K = ±10% M = ±20%	A = Not Applicable	G* = 1.9 μ" to 7.87 μ" 7 = 100 μ" minimum	2 = 7" Reel 4 = 13" Reel 9 = Bulk U = 4mm TR (01005)	A = Std. Product
							Contact Factory For Multiples*	

* Contact factory for availability.

MLCC Gold Termination – AU Series



Capacitance Range (NP0 Dielectric)

PREFERRED SIZES ARE SHADED

SIZE	AU01		AU02			AU03				AU05					AU06						
Soldering	Reflow/Epoxy/Wire Bond*		Reflow/Epoxy/Wire Bond*			Reflow/Epoxy/Wire Bond				Reflow/Epoxy/Wire Bond					Reflow/Epoxy/Wire Bond						
Packaging	All Paper		All Paper			All Paper				Paper/Embossed					Paper/Embossed						
(L) Length	mm (in.)		mm (in.)			mm (in.)				mm (in.)					mm (in.)						
(W) Width	mm (in.)		mm (in.)			mm (in.)				mm (in.)					mm (in.)						
(t) Terminal	mm (in.)		mm (in.)			mm (in.)				mm (in.)					mm (in.)						
WVDC	16	25	16	25	50	16	25	50	100	16	25	50	100	200	16	25	50	100	200	500	
Cap (pF)	0.5	A	A	C	C	C	G	G	G	G	J	J	J	J	J	J	J	J	J	J	J
	1.0	A	A	C	C	C	G	G	G	G	J	J	J	J	J	J	J	J	J	J	J
	1.2	A	A	C	C	C	G	G	G	G	J	J	J	J	J	J	J	J	J	J	J
	1.5	A	A	C	C	C	G	G	G	G	J	J	J	J	J	J	J	J	J	J	J
	1.8	A	A	C	C	C	G	G	G	G	J	J	J	J	J	J	J	J	J	J	J
	2.2	A	A	C	C	C	G	G	G	G	J	J	J	J	J	J	J	J	J	J	J
	2.7	A	A	C	C	C	G	G	G	G	J	J	J	J	J	J	J	J	J	J	J
	3.3	A	A	C	C	C	G	G	G	G	J	J	J	J	J	J	J	J	J	J	J
	3.9	A	A	C	C	C	G	G	G	G	J	J	J	J	J	J	J	J	J	J	J
	4.7	A	A	C	C	C	G	G	G	G	J	J	J	J	J	J	J	J	J	J	J
	5.6	A	A	C	C	C	G	G	G	G	J	J	J	J	J	J	J	J	J	J	J
	6.8	A	A	C	C	C	G	G	G	G	J	J	J	J	J	J	J	J	J	J	J
	8.2	A	A	C	C	C	G	G	G	G	J	J	J	J	J	J	J	J	J	J	J
	10	A	A	C	C	C	G	G	G	G	J	J	J	J	J	J	J	J	J	J	J
	12	A	A	C	C	C	G	G	G	G	J	J	J	J	J	J	J	J	J	J	J
	15	A	A	C	C	C	G	G	G	G	J	J	J	J	J	J	J	J	J	J	J
	18	A	A	C	C	C	G	G	G	G	J	J	J	J	J	J	J	J	J	J	J
	22	A	A	C	C	C	G	G	G	G	J	J	J	J	J	J	J	J	J	J	J
	27	A	A	C	C	C	G	G	G	G	J	J	J	J	J	J	J	J	J	J	J
	33	A	A	C	C	C	G	G	G	G	J	J	J	J	J	J	J	J	J	J	J
	39	A	A	C	C	C	G	G	G	G	J	J	J	J	J	J	J	J	J	J	J
	47	A	A	C	C	C	G	G	G	G	J	J	J	J	J	J	J	J	J	J	J
	56	A	A	C	C	C	G	G	G	G	J	J	J	J	J	J	J	J	J	J	J
	68	A	A	C	C	C	G	G	G	G	J	J	J	J	J	J	J	J	J	J	J
	82	A	A	C	C	C	G	G	G	G	J	J	J	J	J	J	J	J	J	J	J
	100	A	A	C	C	C	G	G	G	G	J	J	J	J	J	J	J	J	J	J	J
	120			C	C	C	G	G	G	G	J	J	J	J	J	J	J	J	J	J	J
	150			C	C	C	G	G	G	G	J	J	J	J	J	J	J	J	J	J	J
	180			C	C	C	G	G	G	G	J	J	J	J	J	J	J	J	J	J	J
	220			C	C	C	G	G	G	G	J	J	J	J	J	J	J	J	J	J	M
	270			C	C	C	G	G	G	G	J	J	J	J	M	J	J	J	J	J	M
	330			C	C	C	G	G	G	G	J	J	J	J	M	J	J	J	J	J	M
	390			C	C	C	G	G	G		J	J	J	J	M	J	J	J	J	J	M
	470			C	C	C	G	G	G		J	J	J	J	M	J	J	J	J	J	M
	560						G	G	G		J	J	J	J	M	J	J	J	J	J	M
	680						G	G	G		J	J	J	J		J	J	J	J	J	P
	820						G	G	G		J	J	J	J		J	J	J	J	J	
	1000						G	G	G		J	J	J	J		J	J	J	J	J	Q
	1200										J	J	J			J	J	J	J	J	Q
	1500										J	J	J			J	J	J	J	J	Q
	1800										J	J	J			J	J	M	M		
	2200										J	J	N			J	J	M	P		
	2700										J	J	N			J	J	M	P		
	3300										J	J				J	J	M	P		
	3900										J	J				J	J	M	P		
	4700										J	J				J	J	M	P		
	5600															J	J	M			
	6800															M	M				
	8200															M	M				
Cap (µF)	0.010															M	M				
	0.012																				
	0.015																				
	0.018																				
	0.022																				
	0.027																				
	0.033																				
	0.039																				
	0.047																				
	0.068																				
	0.082																				
	0.1																				
WVDC	16	25	16	25	50	16	25	50	100	16	25	50	100	200	16	25	50	100	200	500	
SIZE	AU01		AU02			AU03				AU05					AU06						

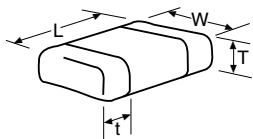

* Contact factory

Letter	A	C	E	G	J	K	M	N	P	Q	X	Y	Z
Max. Thickness	0.33 (0.013)	0.56 (0.022)	0.71 (0.028)	0.90 (0.035)	0.94 (0.037)	1.02 (0.040)	1.27 (0.050)	1.40 (0.055)	1.52 (0.060)	1.78 (0.070)	2.29 (0.090)	2.54 (0.100)	2.79 (0.110)
	PAPER					EMBOSSED							



MLCC Gold Termination – AU Series



Capacitance Range (NP0 Dielectric)

PREFERRED SIZES ARE SHADED

SIZE		AU10					AU12					AU13			AU14		
Soldering		Reflow/Epoxy/ Wire Bond*					Reflow/Epoxy/ Wire Bond*					Reflow/Epoxy/ Wire Bond*			Reflow/Epoxy/ Wire Bond*		
Packaging		Paper/Embossed					All Embossed					All Embossed			All Embossed		
(L) Length	mm (in.)	3.20 ± 0.20 (0.126 ± 0.008)					4.50 ± 0.30 (0.177 ± 0.012)					4.50 ± 0.30 (0.177 ± 0.012)			5.72 ± 0.25 (0.225 ± 0.010)		
(W) Width	mm (in.)	2.50 ± 0.20 (0.098 ± 0.008)					3.20 ± 0.20 (0.126 ± 0.008)					6.40 ± 0.40 (0.252 ± 0.016)			6.35 ± 0.25 (0.250 ± 0.010)		
(t) Terminal	mm (in.)	0.50 ± 0.25 (0.020 ± 0.010)					0.61 ± 0.36 (0.024 ± 0.014)					0.61 ± 0.36 (0.024 ± 0.014)			0.64 ± 0.39 (0.025 ± 0.015)		
WDC		25	50	100	200	500	25	50	100	200	500	50	100	200	50	100	200
Cap (pF)	0.5																
	1.0																
	1.2																
	1.5																
	1.8																
	2.2																
	2.7																
	3.3																
	3.9																
	4.7																
	5.6																
	6.8																
	8.2																
	10					J											
	12					J											
	15					J											
	18					J											
	22					J											
	27					J											
	33					J											
	39					J											
	47					J											
	56					J											
	68					J											
	82					J											
	100					J											
	120					J											
	150					J											
	180					J											
	220					J											
	270					J											
	330					J											
	390					M											
	470					M											
	560	J	J	J	J	M											
	680	J	J	J	J	M											
	820	J	J	J	J	M											
	1000	J	J	J	J	M	K	K	K	K	M	M	M	M	M	M	P
	1200	J	J	J	M	M	K	K	K	K	M	M	M	M	M	M	P
	1500	J	J	J	M	M	K	K	K	K	M	M	M	M	M	M	P
	1800	J	J	J	M		K	K	K	K	M	M	M	M	M	M	P
	2200	J	J	J	Q		K	K	K	K	P	M	M	M	M	M	P
	2700	J	J	J	Q		K	K	K	P	Q	M	M	M	M	M	P
	3300	J	J	J			K	K	K	P	Q	M	M	M	M	M	P
	3900	J	J	M			K	K	K	P	Q	M	M	M	M	M	P
	4700	J	J	M			K	K	K	P	Q	M	M	M	M	M	P
	5600	J	J				K	K	M	P	X	M	M	M	M	M	P
	6800	J	J				K	K	M	X		M	M	M	M	M	P
	8200	J	J				K	M	M			M	M		M	M	P
Cap (µF)	0.010	J	J				K	M	M			M	M		M	M	P
	0.012	J	J				K	M				M	M		M	M	P
	0.015						M	M				M	M		M	M	Y
	0.018						M	M				P	M		M	M	Y
	0.022						M	M				P			M	Y	Y
	0.027						M	M				P			P	Y	Y
	0.033						M	M				P			P		
	0.039						M	M				P			P		
	0.047						M	M				P			P		
	0.068						M	M							P		
	0.082						M	M							Q		
	0.1						M	M							Q		
WDC		25	50	100	200	500	25	50	100	200	500	50	100	200	50	100	200

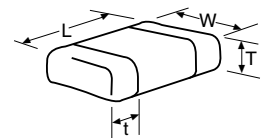

* Contact factory

Letter	A	C	E	G	J	K	M	N	P	Q	X	Y	Z
Max. Thickness	0.33 (0.013)	0.56 (0.022)	0.71 (0.028)	0.90 (0.035)	0.94 (0.037)	1.02 (0.040)	1.27 (0.050)	1.40 (0.055)	1.52 (0.060)	1.78 (0.070)	2.29 (0.090)	2.54 (0.100)	2.79 (0.110)
	PAPER					EMBOSSSED							



MLCC Gold Termination – AU Series



Capacitance Range (X7R Dielectric)

PREFERRED SIZES ARE SHADED

SIZE	AU02			AU03						AU05						AU06										
Soldering	Reflow/Epoxy Wire Bond*			Reflow/Epoxy Wire Bond*						Reflow/Epoxy Wire Bond*						Reflow/Epoxy Wire Bond*										
Packaging	All Paper			All Paper						Paper/Embossed						Paper/Embossed										
(L) Length	mm	1.00 ± 0.10 (0.040 ± 0.004)		1.60 ± 0.15 (0.063 ± 0.006)						2.01 ± 0.20 (0.079 ± 0.008)						3.20 ± 0.20 (0.126 ± 0.008)										
(W) Width	mm	0.50 ± 0.10 (0.020 ± 0.004)		0.81 ± 0.15 (0.032 ± 0.006)						1.25 ± 0.20 (0.049 ± 0.008)						1.60 ± 0.20 (0.063 ± 0.008)										
(t) Terminal	mm	0.25 ± 0.15 (0.010 ± 0.006)		0.35 ± 0.15 (0.014 ± 0.006)						0.50 ± 0.25 (0.020 ± 0.010)						0.50 ± 0.25 (0.020 ± 0.010)										
WVDC		16	25	50	6.3	10	16	25	50	100	200	6.3	10	16	25	50	100	200	6.3	10	16	25	50	100	200	500
Cap (pF)	100																									
	150																									
	220			C																						
	330			C					G	G	G		J	J	J	J	J	J								K
	470			C					G	G	G		J	J	J	J	J	J								K
	680			C					G	G	G		J	J	J	J	J	J								K
	1000			C					G	G	G		J	J	J	J	J	J								K
	1500			C					G	G	G		J	J	J	J	J	J		J	J	J	J	J	J	M
	2200			C					G	G	G		J	J	J	J	J	J		J	J	J	J	J	J	M
	3300			C					G	G	G		J	J	J	J	J	J		J	J	J	J	J	J	M
	4700			C					G	G	G		J	J	J	J	J	J		J	J	J	J	J	J	M
	6800	C	C	C					G	G	G		J	J	J	J	J	J		J	J	J	J	J	J	P
Cap (µF)	0.010	C	C	C					G	G	G		J	J	J	J	J	J		J	J	J	J	J	J	P
	0.015	C	C	C					G	G	G		J	J	J	J	J	J		J	J	J	J	J	J	M
	0.022	C	C	C					G	G	G		J	J	J	J	J	J	N		J	J	J	J	J	M
	0.033								G	G	G		J	J	J	J	J	N		J	J	J	J	J	J	M
	0.047						G	G	G	G	G		J	J	J	J	J	N		J	J	J	J	J	J	M
	0.068						G	G	G	G	G		J	J	J	J	J	N		J	J	J	J	J	J	P
	0.10		C*				G	G	G	G	G		J	J	J	J	N			J	J	J	J	M	P	
	0.15					G	G	G					J	J	J	J	N	N			J	J	J	J	Q	
	0.22					G	G	G					J	J	J	N	N	N			J	J	J	J	Q	
	0.33												N	N	N	N	N	N			J	J	M	P	Q	
	0.47							J*					N	N	N	N	N				M	M	M	P	Q	
	0.68							J*	J*				N	N	N	N					M	M	Q	Q	Q	
	1.0							J*	J*				N	N	N*						M	M	Q	Q	Q	
	1.5												N	N	N						P	Q	Q	Q		
	2.2			J*											P*						Q	Q	Q			
	3.3																									
	4.7												P*	P*							Q*	Q*	Q*			
	10																				Q*	Q*				
	22																									
	47																									
	100																									
WVDC		16	25	50	6.3	10	16	25	50	100	200	6.3	10	16	25	50	100	200	6.3	10	16	25	50	100	200	500
SIZE		AU02			AU03						AU05						AU06									

* Contact factory

Letter	A	C	E	G	J	K	M	N	P	Q	X	Y	Z
Max. Thickness	0.33 (0.013)	0.56 (0.022)	0.71 (0.028)	0.90 (0.035)	0.94 (0.037)	1.02 (0.040)	1.27 (0.050)	1.40 (0.055)	1.52 (0.060)	1.78 (0.070)	2.29 (0.090)	2.54 (0.100)	2.79 (0.110)
	PAPER					EMBOSSSED							

= Under Development

MLCC Gold Termination – AU Series



Capacitance Range (X7R Dielectric)

PREFERRED SIZES ARE SHADED

SIZE	AU10								AU12				AU13		AU14	
	Reflow/Epoxy/ Wire Bond*								Reflow/Epoxy/ Wire Bond*				Reflow/Epoxy/ Wire Bond*		Reflow/Epoxy/ Wire Bond*	
Packaging	Paper/Embossed								All Embossed				All Embossed		All Embossed	
(L) Length	3.20 ± 0.20 (0.126 ± 0.008)								4.50 ± 0.30 (0.177 ± 0.012)				4.50 ± 0.30 (0.177 ± 0.012)		5.72 ± 0.25 (0.225 ± 0.010)	
(W) Width	2.50 ± 0.20 (0.098 ± 0.008)								3.20 ± 0.20 (0.126 ± 0.008)				6.40 ± 0.40 (0.252 ± 0.016)		6.35 ± 0.25 (0.250 ± 0.010)	
(t) Terminal	0.50 ± 0.25 (0.020 ± 0.010)								0.61 ± 0.36 (0.024 ± 0.014)				0.61 ± 0.36 (0.024 ± 0.014)		0.64 ± 0.39 (0.025 ± 0.015)	
WVDC	10	16	25	50	100	200	500	50	100	200	500	50	100	50	100	
Cap (pF)	100															
	150															
	220															
	330															
	470															
	680															
	1000															
	1500	J	J	J	J	J	J	M								
	2200	J	J	J	J	J	J	M								
	3300	J	J	J	J	J	J	M								
	4700	J	J	J	J	J	J	M								
	6800	J	J	J	J	J	J	M								
Cap (µF)	0.010	J	J	J	J	J	J	M	K	K	K	K	M	M	M	P
	0.015	J	J	J	J	J	J	P	K	K	K	P	M	M	M	P
	0.022	J	J	J	J	J	J	Q	K	K	K	P	M	M	M	P
	0.033	J	J	J	J	J	J	Q	K	K	K	X	M	M	M	P
	0.047	J	J	J	J	J	J		K	K	K	Z	M	M	M	P
	0.068	J	J	J	J	J	M		K	K	K	Z	M	M	M	P
	0.10	J	J	J	J	J	M		K	K	K	Z	M	M	M	P
	0.15	J	J	J	J	M	Z		K	K	P		M	M	M	P
	0.22	J	J	J	J	P	Z		K	K	P		M	M	M	P
	0.33	J	J	J	J	Q			K	M	X		M	M	M	P
	0.47	M	M	M	M	Q			K	P			M	M	M	P
	0.68	M	M	P	X	X			M	Q			M	P	M	P
	1.0	N	N	P	X	Z			M	X			M	P	M	P
	1.5	N	N	Z	Z	Z			Z	Z			M		M	X
	2.2	X	X	Z	Z	Z			Z	Z					M	
	3.3	X	X	Z	Z				Z							
	4.7	X	X	Z	Z				Z							
	10	Z	Z	Z												
	22	Z	Z													
	47															
	100															
WVDC	10	16	25	50	100	200	500	50	100	200	500	50	100	50	100	

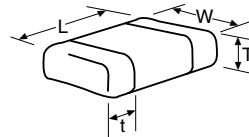

* Contact factory

Letter	A	C	E	G	J	K	M	N	P	Q	X	Y	Z
Max. Thickness	0.33 (0.013)	0.56 (0.022)	0.71 (0.028)	0.90 (0.035)	0.94 (0.037)	1.02 (0.040)	1.27 (0.050)	1.40 (0.055)	1.52 (0.060)	1.78 (0.070)	2.29 (0.090)	2.54 (0.100)	2.79 (0.110)
	PAPER					EMBOSSSED							

MLCC Gold Termination – AU Series



Capacitance Range (X5R Dielectric)

PREFERRED SIZES ARE SHADED

SIZE	AU01				AU02					AU03					AU05					AU06					AU10					AU12										
	6.3	10	16	25	4	6.3	10	16	25	50	4	6.3	10	16	25	35	50	6.3	10	16	25	35	50	6.3	10	16	25	35	50	4	6.3	10	16	25	35	50	6.3	10	25	50
Soldering	Reflow/Epoxy/Wire Bond*				Reflow/Epoxy/Wire Bond*					Reflow/Epoxy/Wire Bond*					Reflow/Epoxy/Wire Bond*					Reflow/Epoxy/Wire Bond*					Reflow/Epoxy/Wire Bond*															
Packaging	All Paper				All Paper					All Paper					Paper/Embossed					Paper/Embossed					Paper/Embossed															
(L) Length	0.60 ± 0.03 (0.024 ± 0.001)				1.00 ± 0.10 (0.040 ± 0.004)					1.60 ± 0.15 (0.063 ± 0.006)					2.01 ± 0.20 (0.079 ± 0.008)					3.20 ± 0.20 (0.126 ± 0.008)					3.20 ± 0.20 (0.126 ± 0.008)															
(W) Width	0.30 ± 0.03 (0.011 ± 0.001)				0.50 ± 0.10 (0.020 ± 0.004)					0.81 ± 0.15 (0.032 ± 0.006)					1.25 ± 0.20 (0.049 ± 0.008)					1.60 ± 0.20 (0.063 ± 0.008)					2.50 ± 0.20 (0.098 ± 0.008)															
(t) Terminal	0.15 ± 0.05 (0.006 ± 0.002)				0.25 ± 0.15 (0.010 ± 0.006)					0.35 ± 0.15 (0.014 ± 0.006)					0.50 ± 0.25 (0.020 ± 0.010)					0.50 ± 0.25 (0.020 ± 0.010)					0.50 ± 0.25 (0.020 ± 0.010)															
WDC	6.3	10	16	25	4	6.3	10	16	25	50	4	6.3	10	16	25	35	50	6.3	10	16	25	35	50	6.3	10	16	25	35	50	4	6.3	10	16	25	35	50	6.3	10	25	50
Cap (pF)	A	A	A	A																																				
	A	A	A	A						C																														
	A	A	A	A						C																														
	A	A	A	A						C																														
	A	A	A	A						C																														
	A	A	A	A						C																														
	A	A	A	A						C																														
	A	A	A	A						C																														
	A	A	A	A						C																														
	A	A	A	A						C																														
	A	A	A	A						C																														
	A	A	A	A						C																														
	A	A	A	A						C																														
	A	A	A	A						C																														
	A	A	A	A						C																														
	A	A	A	A						C																														
	A	A	A	A						C																														
	A	A	A	A						C																														
	A	A	A	A						C																														
	A	A	A	A						C																														
	A	A	A	A						C																														
	A	A	A	A						C																														
	A	A	A	A						C																														
	A	A	A	A						C																														
	A	A	A	A						C																														
	A	A	A	A						C																														
	A	A	A	A						C																														
	A	A	A	A						C																														
	A	A	A	A						C																														
	A	A	A	A						C																														
	A	A	A	A						C																														
	A	A	A	A						C																														
	A	A	A	A						C																														
	A	A	A	A						C																														
	A	A	A	A						C																														
	A	A	A	A						C																														
	A	A	A	A						C																														
	A	A	A	A						C																														
	A	A	A	A						C																														
	A	A	A	A						C																														
	A	A	A	A						C																														
	A	A	A	A						C																														
	A	A	A	A						C																														
	A	A	A	A						C																														
	A	A	A	A						C																														
	A	A	A	A						C																														
	A	A	A	A						C																														
	A	A	A	A						C																														
	A	A	A	A						C																														
	A	A	A	A						C																														
	A	A	A	A						C																														
	A	A	A	A						C																														
	A	A	A	A						C																														
	A	A	A	A						C																														
	A	A	A	A						C																														
	A	A	A	A						C																														
	A	A	A	A						C																														
	A	A	A	A																																				

MLCC Gold Termination – AU Series



0612/0508/0306/Gold LICC (Low Inductance Chip Capacitors)

SIZE	0306					0508					0612					
Packaging	Embossed					Embossed					Embossed					
Length mm (in.)	0.81 ± 0.15 (0.032 ± 0.006)					1.27 ± 0.25 (0.050 ± 0.010)					1.60 ± 0.25 (0.063 ± 0.010)					
Width mm (in.)	1.60 ± 0.15 (0.063 ± 0.006)					2.00 ± 0.25 (0.080 ± 0.010)					3.20 ± 0.25 (0.126 ± 0.010)					
WVDC	4	6.3	10	16	25	50	6.3	10	16	25	50	6.3	10	16	25	50
CAP (µF)	0.001															
	0.0022															
	0.0047															
	0.010															
	0.015															
	0.022															
	0.047															
	0.068															
	0.10															
	0.15															
	0.22															
	0.47															
	0.68															
	1.0															
	1.5															
	2.2															
	3.3															
	4.7															
	10															

Solid = X7R = X5R

= X7S = X6S

mm (in.)	
0306	
Code	Thickness
A	0.61 (0.024)

mm (in.)	
0508	
Code	Thickness
S	0.56 (0.022)
V	0.76 (0.030)
A	1.02 (0.040)

mm (in.)	
0612	
Code	Thickness
S	0.56 (0.022)
V	0.76 (0.030)
W	1.02 (0.040)
A	1.27 (0.050)

PHYSICAL DIMENSIONS AND PAD LAYOUT

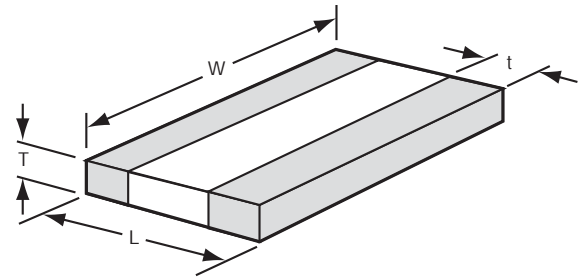

PHYSICAL CHIP DIMENSIONS mm (in)

	L	W	t
0612	1.60 ± 0.25 (0.063 ± 0.010)	3.20 ± 0.25 (0.126 ± 0.010)	0.13 min. (0.005 min.)
0508	1.27 ± 0.25 (0.050 ± 0.010)	2.00 ± 0.25 (0.080 ± 0.010)	0.13 min. (0.005 min.)
0306	0.81 ± 0.15 (0.032 ± 0.006)	1.60 ± 0.15 (0.063 ± 0.006)	0.13 min. (0.005 min.)

T - See Range Chart for Thickness and Codes

PAD LAYOUT DIMENSIONS mm (in)

	A	B	C
0612	0.76 (0.030)	3.05 (0.120)	.635 (0.025)
0508	0.51 (0.020)	2.03 (0.080)	0.51 (0.020)
0306	0.31 (0.012)	1.52 (0.060)	0.51 (0.020)

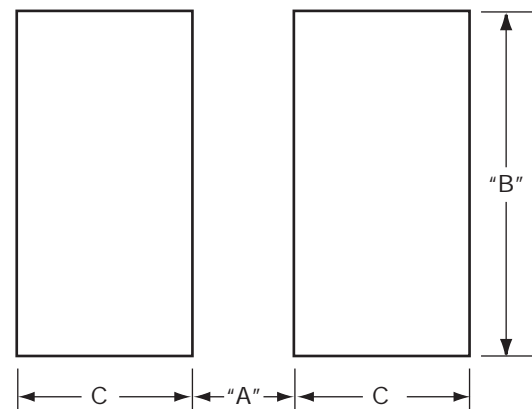

MLCC Tin/Lead Termination “B”



General Specifications

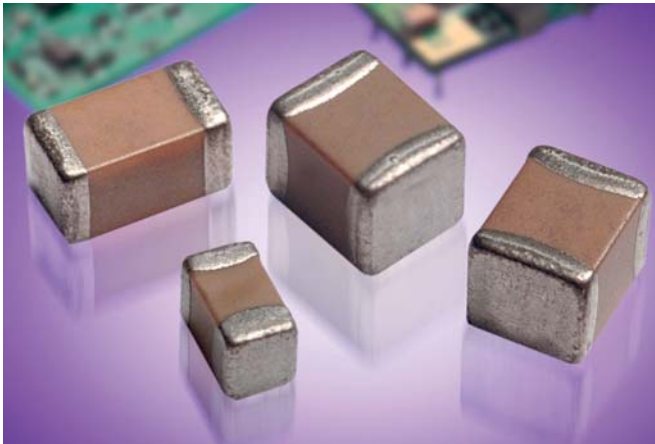

AVX Corporation will support those customers for commercial and military Multilayer Ceramic Capacitors with a termination consisting of 5% minimum lead. This termination is indicated by the use of a “B” in the 12th position of the AVX Catalog Part Number. This fulfills AVX’s commitment to providing a full range of products to our customers. AVX has provided in the following pages a full range of values that we are currently offering in this special “B” termination. Please contact the factory if you require additional information on our MLCC Tin/Lead Termination “B” products.

Not RoHS Compliant

PART NUMBER (see page 2 for complete part number explanation)

LD05	5	A	101	J	A	B	2	A
Size	Voltage	Dielectric	Capacitance Code (In pF)	Capacitance Tolerance	Failure Rate	Terminations	Packaging	Special Code
LD02 - 0402 LD03 - 0603 LD04 - 0504* LD05 - 0805 LD06 - 1206 LD10 - 1210 LD12 - 1812 LD13 - 1825 LD14 - 2225 LD20 - 2220	6.3V = 6 10V = Z 16V = Y 25V = 3 35V = D 50V = 5 100V = 1 200V = 2 500V = 7	COG (NP0) = A X7R = C X5R = D X8R = F	2 Sig. Digits + Number of Zeros	B = ±.10 pF (<10pF) C = ±.25 pF (<10pF) D = ±.50 pF (<10pF) F = ±1% (≥ 10 pF) G = ±2% (≥ 10 pF) J = ±5% K = ±10% M = ±20%	A = Not Applicable	B = 5% min lead X = FLEXITERM® with 5% min lead**	2 = 7" Reel 4 = 13" Reel 7 = Bulk Cass. 9 = Bulk	A = Std. Product
						**X7R only	Contact Factory For Multiples	

*LD04 has the same CV ranges as LD03.

NOTE: Contact factory for availability of Tolerance Options for Specific Part Numbers.
Contact factory for non-specified capacitance values.

See FLEXITERM® section
for CV options

NP0	Refer to page 4 for Electrical Graphs
X7R	Refer to page 17 for Electrical Graphs
X7S	Refer to page 21 for Electrical Graphs
X5R	Refer to page 24 for Electrical Graphs
Y5V	Refer to page 27 for Electrical Graphs



MLCC Tin/Lead Termination "B"



Capacitance Range (NP0 Dielectric)

PREFERRED SIZES ARE SHADED

SIZE	LD02			LD03			LD05				LD06								
Soldering	Reflow/Wave			Reflow/Wave			Reflow/Wave				Reflow/Wave								
Packaging	All Paper			All Paper			Paper/Embossed				Paper/Embossed								
(L) Length	1.00 ± 0.10 (0.040 ± 0.004)			1.60 ± 0.15 (0.063 ± 0.006)			2.01 ± 0.20 (0.079 ± 0.008)				3.20 ± 0.20 (0.126 ± 0.008)								
(W) Width	0.50 ± 0.10 (0.020 ± 0.004)			0.81 ± 0.15 (0.032 ± 0.006)			1.25 ± 0.20 (0.049 ± 0.008)				1.60 ± 0.20 (0.063 ± 0.008)								
(t) Terminal	0.25 ± 0.15 (0.010 ± 0.006)			0.35 ± 0.15 (0.014 ± 0.006)			0.50 ± 0.25 (0.020 ± 0.010)				0.50 ± 0.25 (0.020 ± 0.010)								
WVDC	16	25	50	16	25	50	100	16	25	50	100	200	16	25	50	100	200	500	
Cap (pF)	0.5	C	C	C	G	G	G	G	J	J	J	J	J	J	J	J	J	J	J
	1.0	C	C	C	G	G	G	G	J	J	J	J	J	J	J	J	J	J	J
	1.2	C	C	C	G	G	G	G	J	J	J	J	J	J	J	J	J	J	J
	1.5	C	C	C	G	G	G	G	J	J	J	J	J	J	J	J	J	J	J
	1.8	C	C	C	G	G	G	G	J	J	J	J	J	J	J	J	J	J	J
	2.2	C	C	C	G	G	G	G	J	J	J	J	J	J	J	J	J	J	J
	2.7	C	C	C	G	G	G	G	J	J	J	J	J	J	J	J	J	J	J
	3.3	C	C	C	G	G	G	G	J	J	J	J	J	J	J	J	J	J	J
	3.9	C	C	C	G	G	G	G	J	J	J	J	J	J	J	J	J	J	J
	4.7	C	C	C	G	G	G	G	J	J	J	J	J	J	J	J	J	J	J
	5.6	C	C	C	G	G	G	G	J	J	J	J	J	J	J	J	J	J	J
	6.8	C	C	C	G	G	G	G	J	J	J	J	J	J	J	J	J	J	J
	8.2	C	C	C	G	G	G	G	J	J	J	J	J	J	J	J	J	J	J
	10	C	C	C	G	G	G	G	J	J	J	J	J	J	J	J	J	J	J
	12	C	C	C	G	G	G	G	J	J	J	J	J	J	J	J	J	J	J
	15	C	C	C	G	G	G	G	J	J	J	J	J	J	J	J	J	J	J
	18	C	C	C	G	G	G	G	J	J	J	J	J	J	J	J	J	J	J
	22	C	C	C	G	G	G	G	J	J	J	J	J	J	J	J	J	J	J
	27	C	C	C	G	G	G	G	J	J	J	J	J	J	J	J	J	J	J
	33	C	C	C	G	G	G	G	J	J	J	J	J	J	J	J	J	J	J
	39	C	C	C	G	G	G	G	J	J	J	J	J	J	J	J	J	J	J
	47	C	C	C	G	G	G	G	J	J	J	J	J	J	J	J	J	J	J
	56	C	C	C	G	G	G	G	J	J	J	J	J	J	J	J	J	J	J
	68	C	C	C	G	G	G	G	J	J	J	J	J	J	J	J	J	J	J
	82	C	C	C	G	G	G	G	J	J	J	J	J	J	J	J	J	J	J
	100	C	C	C	G	G	G	G	J	J	J	J	J	J	J	J	J	J	J
	120	C	C	C	G	G	G	G	J	J	J	J	J	J	J	J	J	J	J
	150	C	C	C	G	G	G	G	J	J	J	J	J	J	J	J	J	J	J
	180	C	C	C	G	G	G	G	J	J	J	J	J	J	J	J	J	J	J
	220	C	C	C	G	G	G	G	J	J	J	J	J	J	J	J	J	J	M
	270	C	C	C	G	G	G	G	J	J	J	J	M	J	J	J	J	J	M
	330	C	C	C	G	G	G	G	J	J	J	J	M	J	J	J	J	J	M
	390	C	C	C	G	G	G	G	J	J	J	J	M	J	J	J	J	J	M
	470	C	C	C	G	G	G	G	J	J	J	J	M	J	J	J	J	J	M
	560				G	G	G		J	J	J	J	M	J	J	J	J	J	M
	680				G	G	G		J	J	J	J		J	J	J	J	J	P
	820				G	G	G		J	J	J	J		J	J	J	J	M	
	1000				G	G	G		J	J	J	J		J	J	J	J	J	Q
	1200								J	J	J	J		J	J	J	J	J	Q
	1500								J	J	J	J		J	J	M			Q
	1800								J	J	J			J	J	M			
	2200								J	J	N			J	J	M			P
	2700								J	J	N			J	J	M			P
	3300								J	J				J	J	M			P
	3900								J	J				J	J	M			P
	4700								J	J				J	J	M			P
	5600													J	J	M			
	6800													M	M				
	8200													M	M				
Cap (µF)	0.010													M	M				
	0.012																		
	0.015																		
	0.018																		
	0.022																		
	0.027																		
	0.033																		
	0.039																		
	0.047																		
	0.068																		
	0.082																		
	0.1																		
WVDC	16	25	50	16	25	50	100	16	25	50	100	200	16	25	50	100	200	500	

Letter	A	C	E	G	J	K	M	N	P	Q	X	Y	Z
Max. Thickness	0.33 (0.013)	0.56 (0.022)	0.71 (0.028)	0.90 (0.035)	0.94 (0.037)	1.02 (0.040)	1.27 (0.050)	1.40 (0.055)	1.52 (0.060)	1.78 (0.070)	2.29 (0.090)	2.54 (0.100)	2.79 (0.110)
	PAPER					EMBOSSSED							

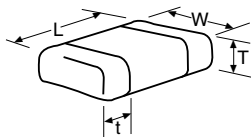

MLCC Tin/Lead Termination "B"



Capacitance Range (NP0 Dielectric)

PREFERRED SIZES ARE SHADED

SIZE		LD10					LD12					LD13			LD14		
Soldering		Reflow Only					Reflow Only					Reflow Only			Reflow Only		
Packaging		Paper/Embossed					All Embossed					All Embossed			All Embossed		
(L) Length	mm	3.20 ± 0.20 (0.126 ± 0.008)					4.50 ± 0.30 (0.177 ± 0.012)					4.50 ± 0.30 (0.177 ± 0.012)			5.72 ± 0.25 (0.225 ± 0.010)		
(W) Width	mm	2.50 ± 0.20 (0.098 ± 0.008)					3.20 ± 0.20 (0.126 ± 0.008)					6.40 ± 0.40 (0.252 ± 0.016)			6.35 ± 0.25 (0.250 ± 0.010)		
(t) Terminal	mm	0.50 ± 0.25 (0.020 ± 0.010)					0.61 ± 0.36 (0.024 ± 0.014)					0.61 ± 0.36 (0.024 ± 0.014)			0.64 ± 0.39 (0.025 ± 0.015)		
Cap	WVDC	25	50	100	200	500	25	50	100	200	500	50	100	200	50	100	200
0.5	0.5																
1.0	1.0																
1.2	1.2																
1.5	1.5																
1.8	1.8																
2.2	2.2																
2.7	2.7																
3.3	3.3																
3.9	3.9																
4.7	4.7																
5.6	5.6																
6.8	6.8																
8.2	8.2																
10	10					J											
12	12					J											
15	15					J											
18	18					J											
22	22					J											
27	27					J											
33	33					J											
39	39					J											
47	47					J											
56	56					J											
68	68					J											
82	82					J											
100	100					J											
120	120					J											
150	150					J											
180	180					J											
220	220					J											
270	270					J											
330	330					J											
390	390					M											
470	470					M											
560	560	J	J	J	J	M											
680	680	J	J	J	J	M											
820	820	J	J	J	J	M											
1000	1000	J	J	J	J	M	K	K	K	K	M	M	M	M	M	M	P
1200	1200	J	J	J	M	M	K	K	K	K	M	M	M	M	M	M	P
1500	1500	J	J	J	M	M	K	K	K	K	M	M	M	M	M	M	P
1800	1800	J	J	J	M		K	K	K	K	M	M	M	M	M	M	P
2200	2200	J	J	J	Q		K	K	K	K	P	M	M	M	M	M	P
2700	2700	J	J	J	Q		K	K	K	P	Q	M	M	M	M	M	P
3300	3300	J	J	J			K	K	K	P	Q	M	M	M	M	M	P
3900	3900	J	J	M			K	K	K	P	Q	M	M	M	M	M	P
4700	4700	J	J	M			K	K	K	P	Q	M	M	M	M	M	P
5600	5600	J	J				K	K	M	P	X	M	M	M	M	M	P
6800	6800	J	J				K	K	M	X		M	M	M	M	M	P
8200	8200	J	J				K	M	M			M	M		M	M	P
Cap (µF)	0.010	J	J				K	M	M			M	M		M	M	P
	0.012	J	J				K	M				M	M		M	M	P
	0.015						M	M				M	M		M	M	Y
	0.018						M	M				P	M		M	M	Y
	0.022						M	M				P			M	Y	Y
	0.027						M	M				P			P	Y	Y
	0.033						M	M				P			P		
	0.039						M	M				P			P		
	0.047						M	M				P			P		
	0.068						M	M							P		
	0.082						M	M							Q		
	0.1														Q		
	WVDC	25	50	100	200	500	25	50	100	200	500	50	100	200	50	100	200

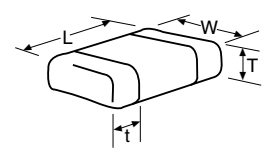

MLCC Tin/Lead Termination "B"



Capacitance Range (X8R Dielectric)

SIZE		LD03		LD05		LD06	
	WVDC	25V	50V	25V	50V	25V	50V
271	Cap 270	G	G				
331	(pF) 330	G	G	J	J		
471	470	G	G	J	J		
681	680	G	G	J	J		
102	1000	G	G	J	J	J	J
152	1500	G	G	J	J	J	J
182	1800	G	G	J	J	J	J
222	2200	G	G	J	J	J	J
272	2700	G	G	J	J	J	J
332	3300	G	G	J	J	J	J
392	3900	G	G	J	J	J	J
472	4700	G	G	J	J	J	J
562	5600	G	G	J	J	J	J
682	6800	G	G	J	J	J	J
822	8200	G	G	J	J	J	J
103	Cap 0.01	G	G	J	J	J	J
123	(µF) 0.012	G	G	J	J	J	J
153	0.015	G	G	J	J	J	J
183	0.018	G	G	J	J	J	J
223	0.022	G	G	J	J	J	J
273	0.027	G	G	J	J	J	J
333	0.033	G	G	J	J	J	J
393	0.039	G	G	J	J	J	J
473	0.047	G	G	J	J	J	J
563	0.056	G		N	N	M	M
683	0.068	G		N	N	M	M
823	0.082			N	N	M	M
104	0.1			N	N	M	M
124	0.12			N	N	M	M
154	0.15			N	N	M	M
184	0.18			N		M	M
224	0.22			N		M	M
274	0.27					M	M
334	0.33					M	M
394	0.39					M	
474	0.47					M	
684	0.68						
824	0.82						
105	1						
SIZE	WVDC	25V	50V	25V	50V	25V	50V
		LD03		LD05		LD06	

Letter	A	C	E	G	J	K	M	N	P	Q	X	Y	Z
Max. Thickness	0.33 (0.013)	0.56 (0.022)	0.71 (0.028)	0.90 (0.035)	0.94 (0.037)	1.02 (0.040)	1.27 (0.050)	1.40 (0.055)	1.52 (0.060)	1.78 (0.070)	2.29 (0.090)	2.54 (0.100)	2.79 (0.110)
	PAPER					EMBOSSSED							



MLCC Tin/Lead Termination “B”



Capacitance Range (X7R Dielectric)

PREFERRED SIZES ARE SHADED

SIZE	LD02			LD03						LD05						LD06									
Soldering	Reflow/Wave			Reflow/Wave						Reflow/Wave						Reflow/Wave									
Packaging	All Paper			All Paper						Paper/Embossed						Paper/Embossed									
(L) Length	1.00 ± 0.10 (0.040 ± 0.004)			1.60 ± 0.15 (0.063 ± 0.006)						2.01 ± 0.20 (0.079 ± 0.008)						3.20 ± 0.20 (0.126 ± 0.008)									
(W) Width	0.50 ± 0.10 (0.020 ± 0.004)			0.81 ± 0.15 (0.032 ± 0.006)						1.25 ± 0.20 (0.049 ± 0.008)						1.60 ± 0.20 (0.063 ± 0.008)									
(t) Terminal	0.25 ± 0.15 (0.010 ± 0.006)			0.35 ± 0.15 (0.014 ± 0.006)						0.50 ± 0.25 (0.020 ± 0.010)						0.50 ± 0.25 (0.020 ± 0.010)									
WDC	16	25	50	6.3	10	16	25	50	100	200	6.3	10	16	25	50	100	200	6.3	10	16	25	50	100	200	500
Cap (pF)			C																						
100																									
150																									
220			C																						
330			C					G	G	G		J	J	J	J	J	J								K
470			C					G	G	G		J	J	J	J	J	J								K
680			C					G	G	G		J	J	J	J	J	J								K
1000			C					G	G	G		J	J	J	J	J	J								K
1500			C					G	G	G		J	J	J	J	J	J		J	J	J	J	J	J	M
2200			C					G	G	G		J	J	J	J	J	J		J	J	J	J	J	J	M
3300		C	C					G	G	G		J	J	J	J	J	J		J	J	J	J	J	J	M
4700		C	C					G	G	G		J	J	J	J	J	J		J	J	J	J	J	J	M
6800	G	C	C					G	G	G		J	J	J	J	J	J		J	J	J	J	J	J	P
Cap (µF)		C						G	G	G		J	J	J	J	J	J		J	J	J	J	J	J	P
0.010		C						G	G	G		J	J	J	J	J	J		J	J	J	J	J	J	P
0.015		C						G	G	G		J	J	J	J	J	J		J	J	J	J	J	J	M
0.022		C						G	G	G		J	J	J	J	J	J		J	J	J	J	J	J	M
0.033								G	G	G		J	J	J	J	N	N		J	J	J	J	J	J	M
0.047							G	G	G	G		J	J	J	J	N	N		J	J	J	J	J	J	M
0.068							G	G	G	G		J	J	J	J	N	N		J	J	J	J	J	J	P
0.10		C*					G	G	G	G		J	J	J	J	N	N		J	J	J	J	J	J	P
0.15							G	G	G	G		J	J	J	J	N	N		J	J	J	J	J	J	M
0.22							G	G	G	G		J	J	J	J	N	N		J	J	J	J	J	J	Q
0.33												N	N	N	N	N	N		J	J	J	J	J	J	Q
0.47							J*					N	N	N	N	N	N		M	M	M	M	P	P	Q
0.68							J*	J*				N	N	N	N	N	N		M	M	M	M	Q	Q	Q
1.0							J*	J*				N	N	N*					M	M	Q	Q	Q	Q	
1.5																			P	Q	Q	Q			
2.2							J*									P*			Q	Q	Q				
3.3																									
4.7													P*	P*											
10																			Q*	Q*	Q*				
22																			Q*						
47																									
100																									
WDC	16	25	50	6.3	10	16	25	50	100	200	6.3	10	16	25	50	100	200	6.3	10	16	25	50	100	200	500

Letter	A	C	E	G	J	K	M	N	P	Q	X	Y	Z
Max. Thickness	0.33 (0.013)	0.56 (0.022)	0.71 (0.028)	0.90 (0.035)	0.94 (0.037)	1.02 (0.040)	1.27 (0.050)	1.40 (0.055)	1.52 (0.060)	1.78 (0.070)	2.29 (0.090)	2.54 (0.100)	2.79 (0.110)
	PAPER					EMBOSSSED							

= Under Development

MLCC Tin/Lead Termination "B"



Capacitance Range (X7R Dielectric)

PREFERRED SIZES ARE SHADED

SIZE		LD10							LD12				LD13		LD20				LD14	
Soldering		Reflow Only							Reflow Only				Reflow Only		Reflow Only				Reflow Only	
Packaging		Paper/Embossed							All Embossed				All Embossed		All Embossed				All Embossed	
(L) Length	mm (in.)	3.20 ± 0.20 (0.126 ± 0.008)							4.50 ± 0.30 (0.177 ± 0.012)				4.50 ± 0.30 (0.177 ± 0.012)		5.70 ± 0.40 (0.225 ± 0.016)				5.72 ± 0.25 (0.225 ± 0.010)	
(W) Width	mm (in.)	2.50 ± 0.20 (0.098 ± 0.008)							3.20 ± 0.20 (0.126 ± 0.008)				6.40 ± 0.40 (0.252 ± 0.016)		5.00 ± 0.40 (0.197 ± 0.016)				6.35 ± 0.25 (0.250 ± 0.010)	
(t) Terminal	mm (in.)	0.50 ± 0.25 (0.020 ± 0.010)							0.61 ± 0.36 (0.024 ± 0.014)				0.61 ± 0.36 (0.024 ± 0.014)		0.64 ± 0.39 (0.025 ± 0.015)				0.64 ± 0.39 (0.025 ± 0.015)	
WVDC		10	16	25	50	100	200	500	50	100	200	500	50	100	25	50	100	200	50	100
Cap (pF)	100																			
	150																			
	220																			
	330																			
	470																			
	680																			
	1000	J	J	J	J	J	J	M												
	1500	J	J	J	J	J	J	M												
	2200	J	J	J	J	J	J	M												
	3300	J	J	J	J	J	J	M												
	4700	J	J	J	J	J	J	M												
	6800	J	J	J	J	J	J	M												
Cap (µF)	0.010	J	J	J	J	J	J	M	K	K	K	K	M	M		X	X	X	M	P
	0.015	J	J	J	J	J	J	P	K	K	K	P	M	M		X	X	X	M	P
	0.022	J	J	J	J	J	J	Q	K	K	K	P	M	M		X	X	X	M	P
	0.033	J	J	J	J	J	J	Q	K	K	K	X	M	M		X	X	X	M	P
	0.047	J	J	J	J	J	J		K	K	K	Z	M	M		X	X	X	M	P
	0.068	J	J	J	J	J	M		K	K	K	Z	M	M		X	X	X	M	P
	0.10	J	J	J	J	J	M		K	K	K	Z	M	M		X	X	X	M	P
	0.15	J	J	J	J	M	Z		K	K	P		M	M		X	X	X	M	P
	0.22	J	J	J	J	P	Z		K	K	P		M	M		X	X	X	M	P
	0.33	J	J	J	J	Q			K	M	X		M	M		X	X	X	M	P
	0.47	M	M	M	M	Q			K	P			M	M		X	X	X	M	P
	0.68	M	M	P	X	X			M	Q			M	P		X	X		M	P
	1.0	N	N	P	X	Z			M	X			M	P		X	X		M	P
	1.5	N	N	Z	Z	Z			Z	Z			M			X	X		M	X
	2.2	X	X	Z	Z	Z			Z	Z						X	X		M	
	3.3	X	X	Z	Z				Z							X	Z			
	4.7	X	X	Z	Z				Z							X	Z			
	10	Z	Z	Z												Z				
	22	Z	Z												Z					
	47																			
	100																			
WVDC		10	16	25	50	100	200	500	50	100	200	500	50	100	25	50	100	200	50	100
SIZE		LD10							LD12				LD13		LD20				LD14	

Letter	A	C	E	G	J	K	M	N	P	Q	X	Y	Z
Max. Thickness	0.33 (0.013)	0.56 (0.022)	0.71 (0.028)	0.90 (0.035)	0.94 (0.037)	1.02 (0.040)	1.27 (0.050)	1.40 (0.055)	1.52 (0.060)	1.78 (0.070)	2.29 (0.090)	2.54 (0.100)	2.79 (0.110)
	PAPER					EMBOSS							



MLCC Low Profile



General Specifications

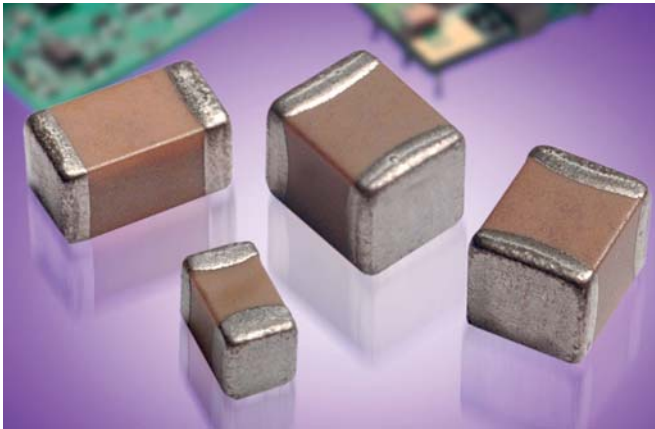

GENERAL DESCRIPTION

AVX introduces the LT series comprising a range of low profile products in our X5R and X7R dielectric. X5R is a Class II dielectric with temperature variation of capacitance within $\pm 15\%$ from -55°C to $+85^{\circ}\text{C}$. Offerings include 0201, 0402, 0603, 0805, 1206, and 1210 packages in compact, low profile designs. The LT series is ideal for decoupling and filtering applications where height clearance is limited.

AVX is also expanding the low profile products in our X7R dielectric. X7R is a Class II dielectric with temperature variation of capacitance within $\pm 15\%$ from -55°C to $+125^{\circ}\text{C}$. Please contact the factory for availability of any additional values not listed.

PART NUMBER (see page 2 for complete part number explanation)

LT05	Z	D	475	K	A	T	2	S
Size	Voltage	Dielectric	Capacitance Code (In pF)	Capacitance Tolerance	Failure Rate	Terminations	Packaging	Special Code
LT01 - 0201 LT02 - 0402 LT03 - 0603 LT05 - 0805 LT06 - 1206 LT10 - 1210	4V = 4 6.3V = 6 10V = Z 16V = Y 25V = 3	X5R = D X7R = C	2 Sig. Digits + Number of Zeros	K = $\pm 10\%$ M = $\pm 20\%$	A = Not Applicable	T = Plated Ni and Sn	2 = 7" Reel 4 = 13" Reel 7 = Bulk Cass. 9 = Bulk	See table below
							Contact Factory For Multiples	

NOTE: Contact factory for availability of tolerance options for specific part numbers.

SIZE			LT01			LT02			LT03			LT05			LT06			LT10				
		WVDC	4	4	6.3	10	16	4	6.3	16	25	6.3	10	16	25	10	16	25	16	25		
Cap (μF)	104	0.10	Z		Q		S															
		0.22										X										
		0.47										X									X	
105	1.0		C		S					S	X			X	X							
	1.5													X								
	2.2		S						S	X				X								
	4.7						S	X					S	X				W	W	W		
106	10						X/W					X	X				W		W	W		
	22																W			W		
	47																					
		WVDC	4	4	6.3	10	16	4	6.3	16	25	6.3	10	16	25	10	16	25	16	25		
SIZE			LT01	LT02			LT03			LT05			LT06			LT10						

X = X7R

Letter	J	Z	Q	C	S	X	W
Max. Thickness	0.15 (0.006)	0.22 (0.009)	0.25 (0.010)	0.36 (0.014)	0.56 (0.022)	0.95 (0.038)	1.02 (0.040)
	PAPER						EMBOSSD



UltraThin Ceramic Capacitors



UT023D103MAT2C

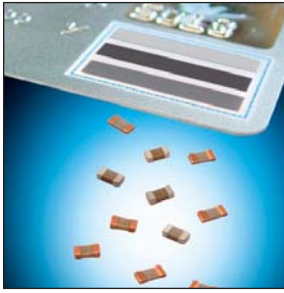

The Ultrathin (UT) series of ceramic capacitors is a new product offering from AVX. The UT series was designed to meet the stringent thickness requirements of our customers. AVX developed a new termination process (FCT - Fine Copper Termination) that provides unbeatable flatness and repeatability. The series includes copper products < 0.35mm in height and is targeted for applications such as Smart cards, Memory modules, High Density SIM cards, Mobile phones, MP3 players, and embedded solutions.



HOW TO ORDER

UT

Style
Ultra
Thin

02

Case
Size
0402

3

Rated
Voltage
25V

D

Temperature
Characteristic
X5R

103

Coded
Cap
0.01 μ F

M

Cap
Tolerance
 $\pm 20\%$

A

Termination
Style
Commercial

T

Termination
100% Sn

2

Packaging
7" Reel = 15,000 pcs
13" Reel = 50,000 pcs

C

Thickness
0.30mm max

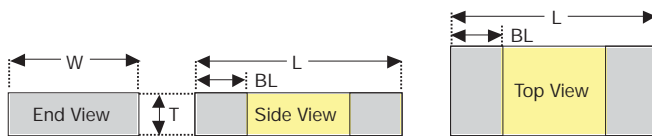

PART DIMENSIONS

inches (mm)

L	W	T	BL
1.00 \pm 0.10 (0.039 \pm 0.004)	0.50 \pm 0.10 (0.020 \pm 0.004)	0.25 \pm 0.05 (0.010 \pm 0.002)	0.25 \pm 0.10 (0.010 \pm 0.004)

RECOMMENDED SOLDER PAD DIMENSIONS

mm (inches)

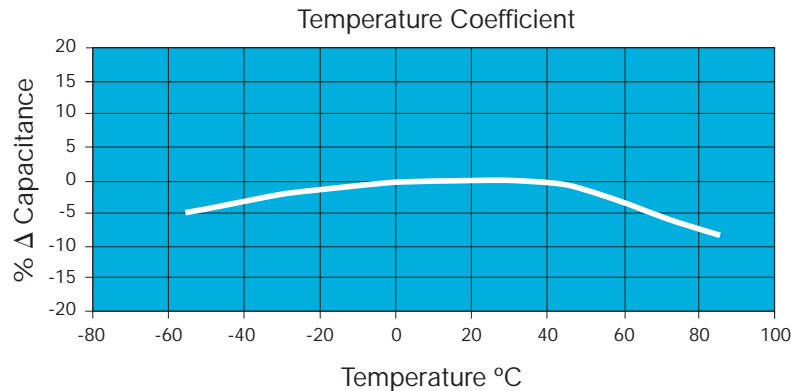
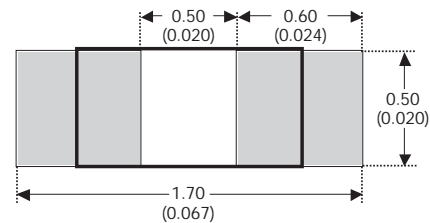

PERFORMANCE CHARACTERISTICS

Capacitance Value	0.01 μ F
Capacitance Tolerance	$\pm 20\%$
Dissipation Factor Range	3.0%
Operating Temperature	-55°C to +85°C
Temperature Coefficient	$\pm 15\%$
Rated Voltage	25V
Insulation Resistance at 25°C and Rated Voltage	100,000 Mohms
Test Frequency	1 Vrms @ 1 KHz

Automotive

GENERAL DESCRIPTION

AVX Corporation has supported the Automotive Industry requirements for Multilayer Ceramic Capacitors consistently for more than 10 years. Products have been developed and tested specifically for automotive applications and all manufacturing facilities are QS9000 and VDA 6.4 approved.

As part of our sustained investment in capacity and state of the art technology, we are now transitioning from the established Pd/Ag electrode system to a Base Metal Electrode system (BME).

AVX is using AECQ200 as the qualification vehicle for this transition. A detailed qualification package is available on request and contains results on a range of part numbers including:

- X7R dielectric components containing BME electrode and copper terminations with a Ni/Sn plated overcoat.
- X7R dielectric components, BME electrode with epoxy finish for conductive glue mounting.
- X7R dielectric components BME electrode and soft terminations with a Ni/Sn plated overcoat.
- NP0 dielectric components containing Pd/Ag electrode and silver termination with a Ni/Sn plated overcoat.

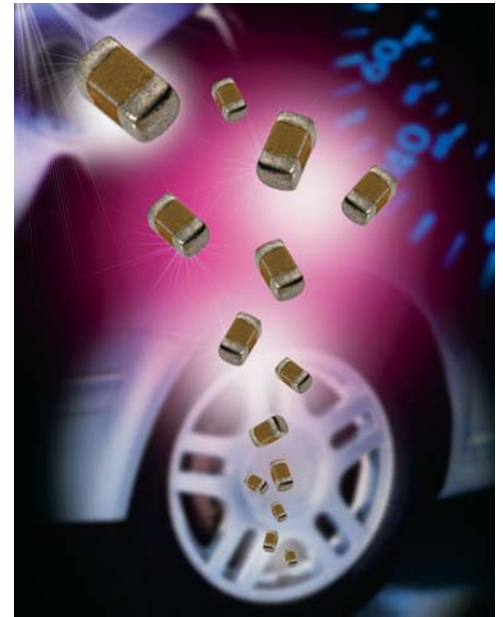

HOW TO ORDER

0805	5	A	104	K	4	T	2	A
Size	Voltage	Dielectric	Capacitance Code (In pF)	Capacitance Tolerance	Failure Rate	Terminations	Packaging	Special Code
0402	10V = Z	NP0 = A	2 Significant Digits + Number of Zeros	F = ±1% (≥10pF)* G = ±2% (≥10pF)* J = ±5% (≤1µF) K = ±10% M = ±20%	4 = Automotive	T = Plated Ni and Sn Z = FLEXITERM®*** U = Conductive Epoxy**	2 = 7" Reel 4 = 13" Reel	A = Std. Product
0603	16V = Y	X7R = C	e.g. 10µF = 106					
0805	25V = 3	X8R = F						
1206	50V = 5							
1210	100V = 1							
1812	200V = 2 500V = 7							
						**X7R & X8R only		

Contact factory for availability of Tolerance Options for Specific Part Numbers.

NOTE: Contact factory for non-specified capacitance values.
0402 case size available in T termination only.



COMMERCIAL VS AUTOMOTIVE MLCC PROCESS COMPARISON

	Commercial	Automotive
Administrative	Standard Part Numbers. No restriction on who purchases these parts.	Specific Automotive Part Number. Used to control supply of product to Automotive customers.
Design	Minimum ceramic thickness of 0.020"	Minimum Ceramic thickness of 0.029" (0.74mm) on all X7R product.
Dicing	Side & End Margins = 0.003" min	Side & End Margins = 0.004" min Cover Layers = 0.005" min
Lot Qualification (Destructive Physical Analysis - DPA)	As per EIA RS469	Increased sample plan – stricter criteria.
Visual/Cosmetic Quality	Standard process and inspection	100% inspection
Application Robustness	Standard sampling for accelerated wave solder on X7R dielectrics	Increased sampling for accelerated wave solder on X7R and NP0 followed by lot by lot reliability testing.

All Tests have Accept/Reject Criteria 0/1

Automotive MLCC

NP0/X7R Dielectric



FLEXITERM® FEATURES

a) Bend Test

The capacitor is soldered to the PC Board as shown:

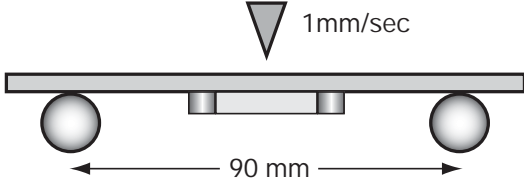

b) Temperature Cycle testing

FLEXITERM® has the ability to withstand at least 1000 cycles between -55°C and +125°C

Typical bend test results are shown below:

Style	Conventional Term	Soft Term
0603	>2mm	>5
0805	>2mm	>5
1206	>2mm	>5

ELECTRODE AND TERMINATION OPTIONS

NP0 DIELECTRIC

**NP0 Ag/Pd Electrode
Nickel Barrier Termination
PCB Application**

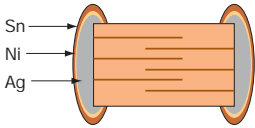

Figure 1 Termination Code T

X7R DIELECTRIC

**X7R Dielectric
PCB Application**

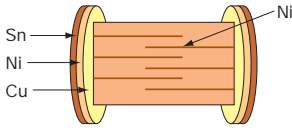

Figure 2 Termination Code T

**X7R Nickel Electrode
Soft Termination
PCB Application**

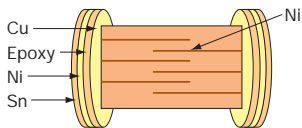

Figure 3 Termination Code Z

**Conductive Epoxy Termination
Hybrid Application**

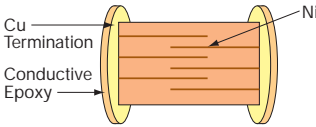

Figure 4 Termination Code U



Automotive MLCC - NP0



Capacitance Range

	0603			0805			1206					1210				1812	
	25V	50V	100V	25V	50V	100V	25V	50V	100V	200V	500V	25V	50V	100V	200V	50V	100V
100 10pF	G	G	G	J	J	J	J	J	J	J	J						
120 12	G	G	G	J	J	J	J	J	J	J	J						
150 15	G	G	G	J	J	J	J	J	J	J	J						
180 18	G	G	G	J	J	J	J	J	J	J	J						
220 22	G	G	G	J	J	J	J	J	J	J	J						
270 27	G	G	G	J	J	J	J	J	J	J	J						
330 33	G	G	G	J	J	J	J	J	J	J	J						
390 39	G	G	G	J	J	J	J	J	J	J	J						
470 47	G	G	G	J	J	J	J	J	J	J	J						
510 51	G	G	G	J	J	J	J	J	J	J	J						
560 56	G	G	G	J	J	J	J	J	J	J	J						
680 68	G	G	G	J	J	J	J	J	J	J	J						
820 82	G	G	G	J	J	J	J	J	J	J	J						
101 100	G	G	G	J	J	J	J	J	J	J	J						
121 120	G	G	G	J	J	J	J	J	J	J	J						
151 150	G	G	G	J	J	J	J	J	J	J	J						
181 180	G	G	G	J	J	J	J	J	J	J	J						
221 220	G	G	G	J	J	J	J	J	J	J	J						
271 270	G	G	G	J	J	J	J	J	J	J	J						
331 330	G	G	G	J	J	J	J	J	J	J	J						
391 390	G	G		J	J	J	J	J	J	J	J						
471 470	G	G		J	J	J	J	J	J	J	J						
561 560				J	J	J	J	J	J	J	J						
681 680				J	J	J	J	J	J	J	J						
821 820				J	J	J	J	J	J	J	J						
102 1000				J	J	J	J	J	J	J	J	J	J	J			
122 1200							J	J	J	J	J	J	J	J			
152 1500							J	M	M	M		J	J	M	M		
182 1800							J	M	M	M		J	J	M	M		
222 2200							J	M	M	M		J	J	M	M		
272 2700							J	M	Q			J	J	M			
332 3300							J	M	Q			J	J	P		K	K
392 3900												J	J	P		K	K
472 4700												J	J	P		K	K
103 10nF																	
	25V	50V	100V	25V	50V	100V	25V	50V	100V	200V	500V	25V	50V	100V	200V	50V	100V
	0603			0805			1206					1210				1812	

Letter	A	C	E	G	J	K	M	N	P	Q	X	Y	Z
Max. Thickness	0.33 (0.013)	0.56 (0.022)	0.71 (0.028)	0.90 (0.035)	0.94 (0.037)	1.02 (0.040)	1.27 (0.050)	1.40 (0.055)	1.52 (0.060)	1.78 (0.070)	2.29 (0.090)	2.54 (0.100)	2.79 (0.110)
	PAPER					EMBOSSSED							

 = Under Development

Automotive MLCC - X7R



Capacitance Range

		0402			0603				0805				1206					1210				1812		2220				
		16V	25V	50V	16V	25V	50V	100V	200V	16V	25V	50V	100V	200V	16V	25V	50V	100V	200V	500V	16V	25V	50V	100V	50V	100V	25V	50V
221	Cap .22																											
271	(nF) .27																											
331	.33																											
391	.39																											
471	.47																											
561	.56																											
681	.68																											
821	.82																											
102	1				G	G	G	G	G	J	J	J	J	J	J	J	J	J	J	J	J	K	K	K	K	K	K	
182	1.8				G	G	G	G		J	J	J	J	J	J	J	J	J	J	J	J	K	K	K	K	K	K	
222	2.2				G	G	G	G		J	J	J	J	J	J	J	J	J	J	J	J	K	K	K	K	K	K	
332	3.3				G	G	G	G		J	J	J	J	J	J	J	J	J	J	J	J	K	K	K	K	K	K	
472	4.7				G	G	G	G		J	J	J	J	J	J	J	J	J	J	J	J	K	K	K	K	K	K	
103	10				G	G	G	G		J	J	J	J	J	J	J	J	J	J	J	J	K	K	K	K	K	K	
123	12				G	G	G			J	J	J	M		J	J	J	J	J		K	K	K	K	K	K		
153	15				G	G	G			J	J	J	M		J	J	J	J	J		K	K	K	K	K	K		
183	18				G	G	G			J	J	J	M		J	J	J	J	J		K	K	K	K	K	K		
223	22				G	G	G			J	J	J	M		J	J	J	J	J		K	K	K	K	K	K		
273	27				G	G	G			J	J	J	M		J	J	J	J	J		K	K	K	K	K	K		
333	33				G	G	G			J	J	J	M		J	J	J	J	J		K	K	K	K	K	K		
473	47				G	G	G			J	J	J	M		J	J	J	M	J		K	K	K	K	K	K		
563	56				G	G	G			J	J	J	M		J	J	J	M	J		K	K	K	M	K	K		
683	68				G	G	G			J	J	J	M		J	J	J	M	J		K	K	K	M	K	K		
823	82				G	G	G			J	J	J	M		J	J	J	M	J		K	K	K	M	K	K		
104	100				G	G	G			J	J	M	M		J	J	J	M	J		K	K	K	M	K	K		
124	120									J	J	M			J	J	M	M			K	K	K	P	K	K		
154	150									M	N	M			J	J	M	M			K	K	K	P	K	K		
224	220									M	N	M			J	M	M	Q			M	M	M	P	M	M		
334	330									N	N	M			J	M	P	Q			P	P	P	Q	X	X		
474	470									N	N	M			M	M	P	Q			P	P	P	Q	X	X		
684	680									N	N				M	Q	Q	Q			P	P	Q	X	X	X		
105	Cap 1									N	N				M	Q	Q	Q			P	Q	Q	X	X	X		
155	(µF) 1.5														Q	Q					P	Q	Z	Z	X	X		
225	2.2														Q	Q					X	Z	Z	Z	Z	Z		
335	3.3																				X	Z	Z		Z			
475	4.7																				X	Z	Z		Z			
106	10																										Z	
226	22																										Z	
		16V	25V	50V	16V	25V	50V	100V	200V	16V	25V	50V	100V	200V	16V	25V	50V	100V	200V	500V	16V	25V	50V	100V	50V	100V	25V	50V
		0402			0603				0805				1206					1210				1812		2220				

= Under Development

Letter	A	C	E	G	J	K	M	N	P	Q	X	Y	Z
Max. Thickness	0.33 (0.013)	0.56 (0.022)	0.71 (0.028)	0.90 (0.035)	0.94 (0.037)	1.02 (0.040)	1.27 (0.050)	1.40 (0.055)	1.52 (0.060)	1.78 (0.070)	2.29 (0.090)	2.54 (0.100)	2.79 (0.110)
	PAPER					EMBOSSSED							

Automotive MLCC - X8R



Capacitance Range

SIZE		0603		0805		1206	
	WVDC	25V	50V	25V	50V	25V	50V
271	Cap	G	G				
331	(pF)	G	G	J	J		
471	470	G	G	J	J		
681	680	G	G	J	J		
102	1000	G	G	J	J	J	J
152	1500	G	G	J	J	J	J
182	1800	G	G	J	J	J	J
222	2200	G	G	J	J	J	J
272	2700	G	G	J	J	J	J
332	3300	G	G	J	J	J	J
392	3900	G	G	J	J	J	J
472	4700	G	G	J	J	J	J
562	5600	G	G	J	J	J	J
682	6800	G	G	J	J	J	J
822	8200	G	G	J	J	J	J
103	Cap	G	G	J	J	J	J
123	(µF)	G	G	J	J	J	J
153	0.015	G	G	J	J	J	J
183	0.018	G	G	J	J	J	J
223	0.022	G	G	J	J	J	J
273	0.027	G	G	J	J	J	J
333	0.033	G	G	J	J	J	J
393	0.039	G	G	J	J	J	J
473	0.047	G	G	J	J	J	J
563	0.056	G		N	N	M	M
683	0.068	G		N	N	M	M
823	0.082			N	N	M	M
104	0.1			N	N	M	M
124	0.12			N	N	M	M
154	0.15			N	N	M	M
184	0.18			N		M	M
224	0.22			N		M	M
274	0.27					M	M
334	0.33					M	M
394	0.39					M	
474	0.47					M	
684	0.68						
824	0.82						
105	1						
	WVDC	25V	50V	25V	50V	25V	50V
SIZE		0603		0805		1206	

Letter	A	C	E	G	J	K	M	N	P	Q	X	Y	Z
Max. Thickness	0.33 (0.013)	0.56 (0.022)	0.71 (0.028)	0.90 (0.035)	0.94 (0.037)	1.02 (0.040)	1.27 (0.050)	1.40 (0.055)	1.52 (0.060)	1.78 (0.070)	2.29 (0.090)	2.54 (0.100)	2.79 (0.110)
	PAPER					EMBOSSED							

= AEC-Q200 Qualified

APS Series

APS for COTS+ Applications

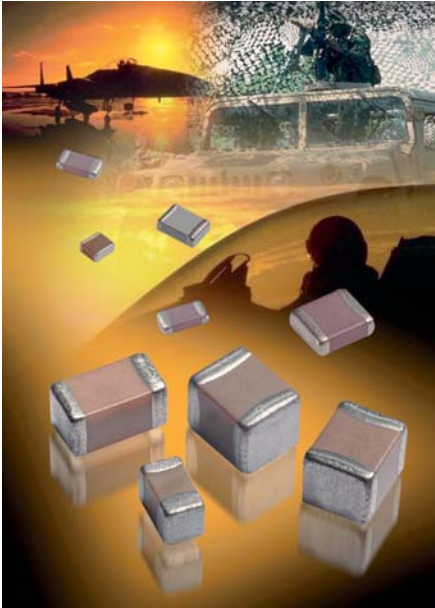

GENERAL DESCRIPTION

As part of our continuing support to high reliability customers, AVX has launched an Automotive Plus Series of parts (APS) qualified and manufactured in accordance with automotive AEC-Q200 standard. Each production batch is quality tested to an enhanced requirement and shipped with a certificate of conformance. On a quarterly basis a reliability package is issued to all APS customers.

A detailed qualification package is available on request and contains results on a range of part numbers including:

- X7R dielectric components containing BME electrode and copper terminations with a Ni/Sn plated overcoat.
- X7R dielectric components BME electrode and soft terminations with a Ni/Sn plated overcoat (FLEXITERM®).
- X7R for Hybrid applications.
- NP0 dielectric components containing Pd/Ag electrode and silver termination with a Ni/Sn plated overcoat.

We are also able to support customers who require an AEC-Q200 grade component finished with Tin/Lead.

HOW TO ORDER

AP03	5	A	104	K	Q	T	2	A
Size	Voltage	Dielectric	Capacitance Code (In pF)	Capacitance Tolerance	Failure Rate Q = APS	Terminations	Packaging	Special Code
AP03=0603	16V = Y	NP0 = A	2 Significant Digits + Number of Zeros e.g. 10µF = 106	J = ±5% K = ±10% M = ±20%		T = Plated Ni and Sn** Z = FLEXITERM®** U = Conductive Epoxy** B = 5% min lead X = FLEXITERM® with 5% min lead	2 = 7" Reel 4 = 13" Reel	A = Std. Product
AP05=0805	25V = 3	X7R = C						
AP06=1206	50V = 5							
AP10=1210	100V = 1							
AP12=1812	200V = 2 500V = 7							
						Z, U, X for X7R only		
						**RoHS compliant		

NOTE: Contact factory for availability of Termination and Tolerance Options for Specific Part Numbers.

Not RoHS Compliant



*For RoHS compliant products,
please select correct termination style.*

NP0 Automotive Plus Series / APS



Capacitance Range

		0603			0805			1206					1210				1812	
		25V	50V	100V	25V	50V	100V	25V	50V	100V	200V	500V	25V	50V	100V	200V	50V	100V
100	10pF	G	G	G	J	J	J	J	J	J	J	J						
120	12	G	G	G	J	J	J	J	J	J	J	J						
150	15	G	G	G	J	J	J	J	J	J	J	J						
180	18	G	G	G	J	J	J	J	J	J	J	J						
220	22	G	G	G	J	J	J	J	J	J	J	J						
270	27	G	G	G	J	J	J	J	J	J	J	J						
330	33	G	G	G	J	J	J	J	J	J	J	J						
390	39	G	G	G	J	J	J	J	J	J	J	J						
470	47	G	G	G	J	J	J	J	J	J	J	J						
510	51	G	G	G	J	J	J	J	J	J	J	J						
560	56	G	G	G	J	J	J	J	J	J	J	J						
680	68	G	G	G	J	J	J	J	J	J	J	J						
820	82	G	G	G	J	J	J	J	J	J	J	J						
101	100	G	G	G	J	J	J	J	J	J	J	J						
121	120	G	G	G	J	J	J	J	J	J	J	J						
151	150	G	G	G	J	J	J	J	J	J	J	J						
181	180	G	G	G	J	J	J	J	J	J	J	J						
221	220	G	G	G	J	J	J	J	J	J	J	J						
271	270	G	G	G	J	J	J	J	J	J	J	J						
331	330	G	G	G	J	J	J	J	J	J	J	J						
391	390	G	G		J	J	J	J	J	J	J	J						
471	470	G	G		J	J	J	J	J	J	J	J						
561	560				J	J	J	J	J	J	J	J						
681	680				J	J	J	J	J	J	J	J						
821	820				J	J	J	J	J	J	J	J						
102	1000				J	J	J	J	J	J	J	J	J	J	J	J		
122	1200							J	J	J			J	J	M	M		
152	1500							J	M	M			J	J	M	M		
182	1800							J	M	M			J	J	M	M		
222	2200							J	M	M			J	J	M	M		
272	2700							J	M	Q			J	J	M			
332	3300							J	M	Q			J	J	P		K	K
392	3900												J	J	P		K	K
472	4700												J	J	P		K	K
103	10nF																	
		0603			0805			1206					1210				1812	
		25V	50V	100V	25V	50V	100V	25V	50V	100V	200V	500V	25V	50V	100V	200V	50V	100V

Letter	A	C	E	G	J	K	M	N	P	Q	X	Y	Z
Max.	0.33	0.56	0.71	0.90	0.94	1.02	1.27	1.40	1.52	1.78	2.29	2.54	2.79
Thickness	(0.013)	(0.022)	(0.028)	(0.035)	(0.037)	(0.040)	(0.050)	(0.055)	(0.060)	(0.070)	(0.090)	(0.100)	(0.110)
	PAPER					EMBOSSSED							

AEC-Q200 qualified
TS 16949, ISO 9001 certified



X7R Automotive Plus Series / APS



Capacitance Range

		0603					0805					1206					1210				1812		2220		
	Cap	16V	25V	50V	100V	200V	16V	25V	50V	100V	200V	16V	25V	50V	100V	200V	500V	16V	25V	50V	100V	50V	100V	25V	50V
102	1	G	G	G	G	G	J	J	J	J	J	J	J	J	J	J	J	K	K	K	K	K	K		
182	1.8	G	G	G	G	G	J	J	J	J	J	J	J	J	J	J	J	K	K	K	K	K	K		
222	2.2	G	G	G	G	G	J	J	J	J	J	J	J	J	J	J	J	K	K	K	K	K	K		
332	3.3	G	G	G	G	G	J	J	J	J	J	J	J	J	J	J	J	K	K	K	K	K	K		
472	4.7	G	G	G	G	G	J	J	J	J	J	J	J	J	J	J	J	K	K	K	K	K	K		
103	10	G	G	G	G	G	J	J	J	J	J	J	J	J	J	J	J	K	K	K	K	K	K		
123	12	G	G	G			J	J	J	M		J	J	J	J	J		K	K	K	K	K	K		
153	15	G	G	G			J	J	J	M		J	J	J	J	J		K	K	K	K	K	K		
183	18	G	G	G			J	J	J	M		J	J	J	J	J		K	K	K	K	K	K		
223	22	G	G	G			J	J	J	M		J	J	J	J	J		K	K	K	K	K	K		
273	27	G	G	G			J	J	J	M		J	J	J	J	J		K	K	K	K	K	K		
333	33	G	G	G			J	J	J	M		J	J	J	J	J		K	K	K	K	K	K		
473	47	G	G	G			J	J	J	M		J	J	J	M	J		K	K	K	K	K	K		
563	56	G	G	G			J	J	J	M		J	J	J	M	J		K	K	K	M	K	K		
683	68	G	G	G			J	J	J	M		J	J	J	M	J		K	K	K	M	K	K		
823	82	G	G	G			J	J	J	M		J	J	J	M	J		K	K	K	M	K	K		
104	100	G	G	G			J	J	M	M		J	J	J	M	J		K	K	K	M	K	K		
124	120						J	J	M			J	J	M	M			K	K	K	P	K	K		
154	150						M	N	M			J	J	M	M			K	K	K	P	K	K		
224	220						M	N	M			J	M	M	Q			M	M	M	P	M	M		
334	330						N	N	M			J	M	P	Q			P	P	P	Q	X	X		
474	470						N	N	M			M	M	P	Q			P	P	P	Q	X	X		
684	680						N	N				M	Q	Q	Q			P	P	Q	X	X	X		
105	1						N	N				M	Q	Q	Q			P	Q	Q	X	X	X		
155	1.5											Q	Q					P	Q	Z	Z	X	X		
225	2.2											Q	Q					X	Z	Z	Z	Z	Z		
335	3.3																	X	Z	Z		Z			
475	4.7																	X	Z	Z		Z			
106	10																								Z
226	22																								Z
		16V	25V	50V	100V	200V	16V	25V	50V	100V	200V	16V	25V	50V	100V	200V	500V	16V	25V	50V	100V	50V	100V	25V	50V
		0603					0805					1206					1210				1812		2220		

= Under Development

Letter	A	C	E	G	J	K	M	N	P	Q	X	Y	Z
Max. Thickness	0.33 (0.013)	0.56 (0.022)	0.71 (0.028)	0.90 (0.035)	0.94 (0.037)	1.02 (0.040)	1.27 (0.050)	1.40 (0.055)	1.52 (0.060)	1.78 (0.070)	2.29 (0.090)	2.54 (0.100)	2.79 (0.110)
	PAPER					EMBOSSSED							

AEC-Q200 qualified
TS 16949, ISO 9001 certified



General Specifications

GENERAL DESCRIPTION

With increased requirements from the automotive industry for additional component robustness, AVX recognized the need to produce a MLCC with enhanced mechanical strength. It was noted that many components may be subject to severe flexing and vibration when used in various under the hood automotive and other harsh environment applications.

To satisfy the requirement for enhanced mechanical strength, AVX had to find a way of ensuring electrical integrity is maintained whilst external forces are being applied to the component. It was found that the structure of the termination needed to be flexible and after much research and development, AVX launched FLEXITERM®. FLEXITERM® is designed to enhance the mechanical flexure and temperature cycling performance of a standard ceramic capacitor with an X7R dielectric. **The industry standard for flexure is 2mm minimum. Using FLEXITERM®, AVX provides up to 5mm of flexure without internal cracks. Beyond 5mm, the capacitor will generally fail “open”.**

As well as for automotive applications FLEXITERM® will provide Design Engineers with a satisfactory solution when designing PCB's which may be subject to high levels of board flexure.

PRODUCT ADVANTAGES

- High mechanical performance able to withstand, 5mm bend test guaranteed.
- Increased temperature cycling performance, 3000 cycles and beyond.
- Flexible termination system.
- Reduction in circuit board flex failures.
- Base metal electrode system.
- Automotive or commercial grade products available.

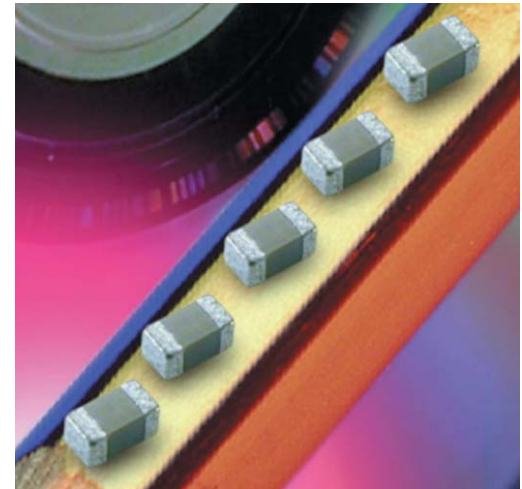

APPLICATIONS

High Flexure Stress Circuit Boards

- e.g. Depanelization: Components near edges of board.

Variable Temperature Applications

- Soft termination offers improved reliability performance in applications where there is temperature variation.
- e.g. All kind of engine sensors: Direct connection to battery rail.

Automotive Applications

- Improved reliability.
- Excellent mechanical performance and thermo mechanical performance.

HOW TO ORDER

0805	5	C	104	K	A	Z	2	A
Style 0603 0805 1206 1210 1812 2220	Voltage 6 = 6.3V Z = 10V Y = 16V 3 = 25V 5 = 50V 1 = 100V 2 = 200V	Dielectric C = X7R F = X8R	Capacitance Code (In pF) 2 Sig Digits + Number of Zeros e.g., 104 = 100nF	Capacitance Tolerance J = ±5%* K = ±10% M = ±20% *≤1µF only	Failure Rate A=Commercial 4 = Automotive	Terminations Z = FLEXITERM® For FLEXITERM® with Tin/Lead termination see AVX LD Series	Packaging 2 = 7" reel 4 = 13" reel	Special Code A = Std. Product

NOTE: Contact factory for availability of Tolerance Options for Specific Part Numbers.

Not RoHS Compliant



For RoHS compliant products,
please select correct termination style.

Specifications and Test Methods

PERFORMANCE TESTING

AEC-Q200 Qualification:

- Created by the Automotive Electronics Council
- Specification defining stress test qualification for passive components



Testing:

Key tests used to compare soft termination to AEC-Q200 qualification:

- Bend Test
- Temperature Cycle Test

BOARD BEND TEST RESULTS

AEC-Q200 Vrs AVX FLEXITERM® Bend Test

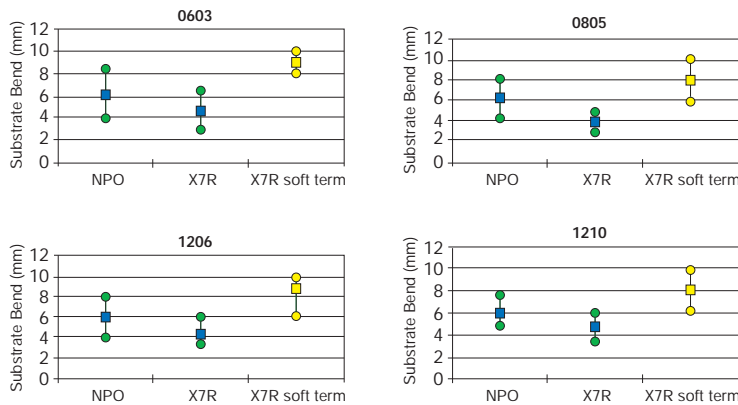

TABLE SUMMARY

Typical bend test results are shown below:

Style	Conventional Termination	FLEXITERM®
0603	>2mm	>5mm
0805	>2mm	>5mm
1206	>2mm	>5mm

TEMPERATURE CYCLE TEST PROCEDURE

Test Procedure as per AEC-Q200:

The test is conducted to determine the resistance of the component when it is exposed to extremes of alternating high and low temperatures.

- Sample lot size quantity 77 pieces
- TC chamber cycle from -55°C to +125°C for 1000 cycles
- Interim electrical measurements at 250, 500, 1000 cycles
- Measure parameter capacitance dissipation factor, insulation resistance

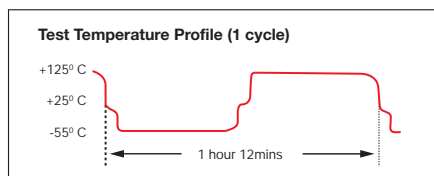

BOARD BEND TEST PROCEDURE

According to AEC-Q200

Test Procedure as per AEC-Q200:

Sample size: 20 components
Span: 90mm Minimum deflection spec: 2 mm

- Components soldered onto FR4 PCB (Figure 1)
- Board connected electrically to the test equipment (Figure 2)

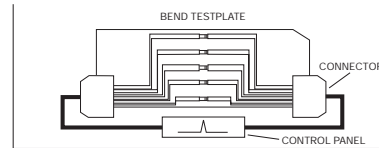

Fig 1 - PCB layout with electrical connections

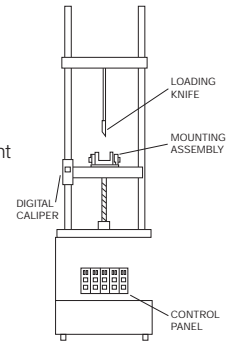
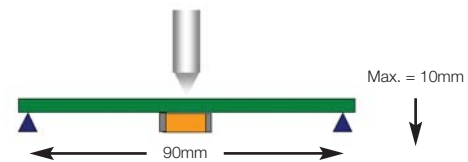

Fig 2 - Board Bend test equipment

AVX ENHANCED SOFT TERMINATION BEND TEST PROCEDURE

Bend Test

The capacitor is soldered to the printed circuit board as shown and is bent up to 10mm at 1mm per second:



- The board is placed on 2 supports 90mm apart (capacitor side down)
- The row of capacitors is aligned with the load stressing knife



- The load is applied and the deflection where the part starts to crack is recorded (Note: Equipment detects the start of the crack using a highly sensitive current detection circuit)
- The maximum deflection capability is 10mm

BEYOND 1000 CYCLES: TEMPERATURE CYCLE TEST RESULTS

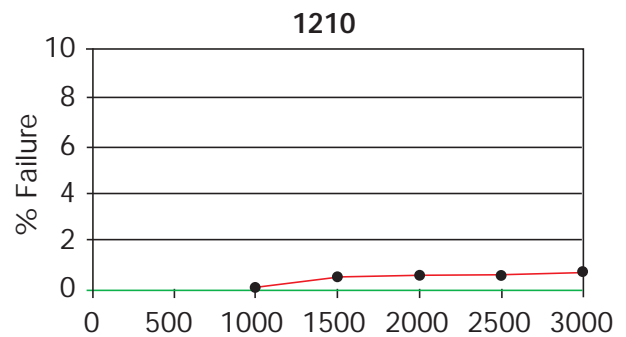
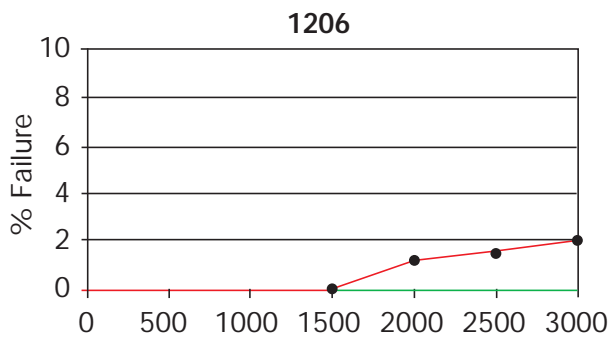
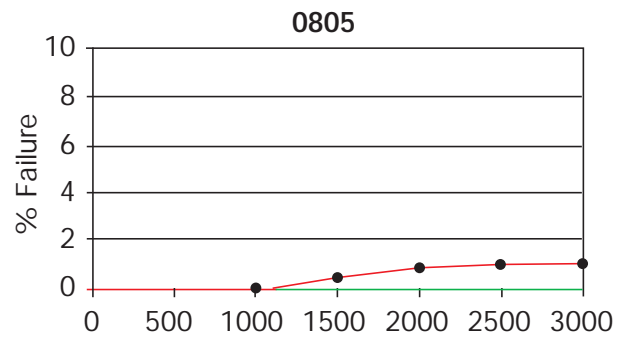
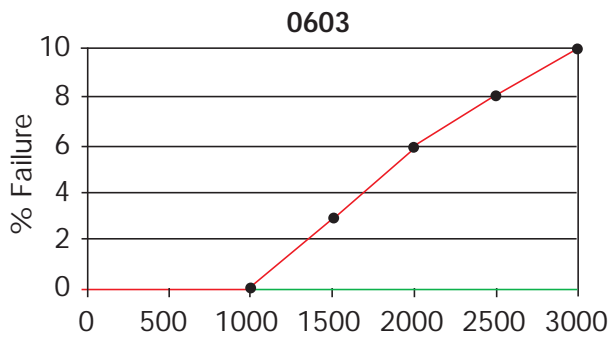

Soft Term - No Defects up to 3000 cycles

AEC-Q200 specification states 1000 cycles compared to AVX 3000 temperature cycles.

FLEXITERM® TEST SUMMARY

- Qualified to AEC-Q200 test/specification with the exception of using AVX 3000 temperature cycles (up to +150°C bend test guaranteed greater than 5mm).
- FLEXITERM® provides improved performance compared to standard termination systems.
- Board bend test improvement by a factor of 2 to 4 times.
- Temperature Cycling:
 - 0% Failure up to 3000 cycles
 - No ESR change up to 3000 cycles

WITHOUT SOFT TERMINATION

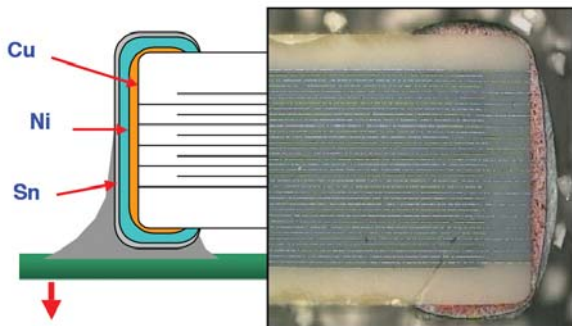

Major fear is of latent board flex failures.

WITH SOFT TERMINATION

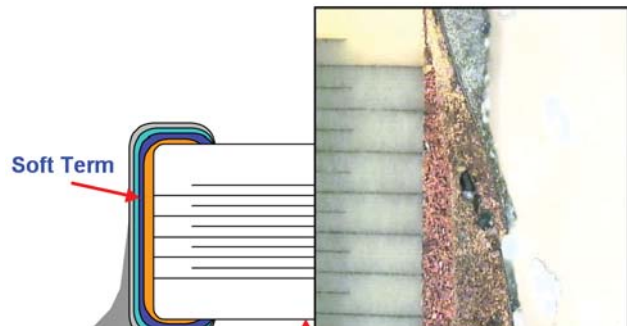

Far superior mechanical performance. Generally open failure mode beyond 5mm flexure.

MLCC with FLEXITERM[®]



X8R Dielectric Capacitance Range

SIZE		0603		0805		1206	
	WVDC	25V	50V	25V	50V	25V	50V
271	Cap	G	G				
331	(pF)	G	G	J	J		
471		G	G	J	J		
681		G	G	J	J		
102		G	G	J	J	J	J
152		G	G	J	J	J	J
182		G	G	J	J	J	J
222		G	G	J	J	J	J
272		G	G	J	J	J	J
332		G	G	J	J	J	J
392		G	G	J	J	J	J
472		G	G	J	J	J	J
562		G	G	J	J	J	J
682		G	G	J	J	J	J
822		G	G	J	J	J	J
103	Cap	G	G	J	J	J	J
123	(µF)	G	G	J	J	J	J
153		G	G	J	J	J	J
183		G	G	J	J	J	J
223		G	G	J	J	J	J
273		G	G	J	J	J	J
333		G	G	J	J	J	J
393		G	G	J	J	J	J
473		G	G	J	J	J	J
563		G		N	N	M	M
683		G		N	N	M	M
823				N	N	M	M
104				N	N	M	M
124				N	N	M	M
154				N	N	M	M
184				N		M	M
224				N		M	M
274						M	M
334						M	M
394						M	
474						M	
684							
824							
105							
SIZE	WVDC	25V	50V	25V	50V	25V	50V

Letter	A	C	E	G	J	K	M	N	P	Q	X	Y	Z
Max. Thickness	0.33 (0.013)	0.56 (0.022)	0.71 (0.028)	0.90 (0.035)	0.94 (0.037)	1.02 (0.040)	1.27 (0.050)	1.40 (0.055)	1.52 (0.060)	1.78 (0.070)	2.29 (0.090)	2.54 (0.100)	2.79 (0.110)
	PAPER					EMBOSSED							

= AEC-Q200 Qualified

X7R Dielectric Capacitance Range

	0603					0805					1206					1210				1812				2220					
	16V	25V	50V	100V	200V	10V	16V	25V	50V	100V	200V	16V	25V	50V	100V	200V	16V	25V	50V	100V	16V	25V	50V	100V	25V	50V	100V		
101																													
121																													
151																													
181																													
221																													
271	J	J	J	J	J	J																							
331	J	J	J	J	J	J	J	J	J	J	J																		
391	J	J	J	J	J	J	J	J	J	J	J																		
471	J	J	J	J	J	J	J	J	J	J	J																		
561	J	J	J	J	J	J	J	J	J	J	J																		
681	J	J	J	J	J	J	J	J	J	J	J																		
821	J	J	J	J	J	J	J	J	J	J	J																		
102	J	J	J	J	J	J	J	J	J	J	J	J	J	J	J														
122	J	J	J	J		J	J	J	J	J	J	J	J	J	J														
152	J	J	J	J		J	J	J	J	J	J	J	J	J	J														
182	J	J	J	J		J	J	J	J	J	J	J	J	J	J														
222	J	J	J	J		J	J	J	J	J	J	J	J	J	J														
272	J	J	J	J		J	J	J	J	J	J	J	J	J	J														
332	J	J	J	J		J	J	J	J	J	J	J	J	J	J														
392	J	J	J	J		J	J	J	J	J	J	J	J	J	J														
472	J	J	J	J		J	J	J	J	J	J	J	J	J	J														
562	J	J	J	J		J	J	J	J	J	J	J	J	J	J														
682	J	J	J	J		J	J	J	J	J	J	J	J	J	J														
822	J	J	J	J		J	J	J	J	J	J	J	J	J	J														
103	J	J	J	J		J	J	J	J	J	J	J	J	J	J														
123	J	J	J			J	J	J	J	M																			
153	J	J	J			J	J	J	J	M																			
183	J	J	J			J	J	J	J	M																			
223	J	J	J			J	J	J	J	M																			
273	J	J	J			J	J	J	J	M																			
333	J	J	J			J	J	J	J	M																			
393	J	J	J			J	J	J	J	M																			
473	J	J	J			J	J	J	J	M																			
563	J	J	J			J	J	J	J	N																			
683	J	J	J			J	J	J	J	N																			
823	J	J	J			J	J	J	J	N																			
104	J	J	J			J	J	J	J	N																			
124						J	J	J	N	N																			
154						M	M	N	N	N																			
184						M	M	N	N	N																			
224						M	M	N	N	N																			
274						N	N	N	N	N																			
334						N	N	N	N	N																			
394						N	N	N	N	N																			
474						N	N	N	N	N																			
564						N	N	N																					
684						N	N	N																					
824						N	N	N																					
105						N	N	N																					
155																													
185																													
225																													
335																													
475																													
106																													
226																													
	16V	25V	50V	100V	200V	10V	16V	25V	50V	100V	200V	16V	25V	50V	100V	200V	16V	25V	50V	100V	16V	25V	50V	100V	25V	50V	100V		
	0603					0805					1206					1210				1812				2220					
Letter	A	C	E	G	J	K	M	N	P	Q	X	Y	Z																
Max. Thickness	0.33 (0.013)	0.56 (0.022)	0.71 (0.028)	0.90 (0.035)	0.94 (0.037)	1.02 (0.040)	1.27 (0.050)	1.40 (0.055)	1.52 (0.060)	1.78 (0.070)	2.29 (0.090)	2.54 (0.100)	2.79 (0.110)																
	PAPER										EMBOSSSED																		

FLEXISAFE MLC Chips



For Ultra Safety Critical Applications



AVX have developed a range of components specifically for safety critical applications.

Utilizing the award-winning FLEXITERM™ layer in conjunction with the cascade design previously used for high voltage MLCCs, a range of ceramic capacitors is now available for customers who require components designed with an industry leading set of safety features.

The FLEXITERM™ layer protects the component from any damage to the ceramic resulting from mechanical stress during PCB assembly or use with end customers. Board flexure type mechanical damage accounts for the majority of MLCC failures. The addition of the cascade structure protects the component from low insulation resistance failure resulting from other common causes for failure; thermal stress damage, repetitive strike ESD damage and placement damage. With the inclusion of the cascade design structure to complement the FLEXITERM™ layer, the FLEXISAFE range of capacitors has unbeatable safety features.

HOW TO ORDER

FS03	5	C	104	K	Q	Z	2	A
Size	Voltage	Dielectric	Capacitance Code (In pF)	Capacitance Tolerance	Failure Rate	Terminations	Packaging	Special Code
FS03 = 0603 FS05 = 0805 FS06 = 1206 FS10 = 1210	16V = Y 25V = 3 50V = 5 100V = 1	X7R = C	2 Sig. Digits + Number of Zeros e.g. 10µF = 106	J = ±5% K = ±10% M = ±20%	A = Commercial 4 = Automotive Q = APS	Z = FLEXITERM™ X = FLEXITERM™ with 5% min lead	2 = 7" Reel 4 = 13" Reel	A = Std. Product

FLEXISAFE X7R RANGE

Capacitance		0603				0805			1206			1210		
Code	nF	16	25	50	100	16	25	50	16	25	50	16	25	50
102	1													
182	1.8													
222	2.2													
332	3.3													
472	4.7													
103	10													
123	12													
153	15													
183	18													
223	22													
273	27													
333	33													
473	47													
563	56													
683	68													
823	82													
104	100													
124	120													
154	150													
224	220													
334	330													
474	470													

Qualified In Qualification

Not RoHS Compliant



For RoHS compliant products, please select correct termination style.



Capacitor Array (IPC)

BENEFITS OF USING CAPACITOR ARRAYS

AVX capacitor arrays offer designers the opportunity to lower placement costs, increase assembly line output through lower component count per board and to reduce real estate requirements.

Reduced Costs

Placement costs are greatly reduced by effectively placing one device instead of four or two. This results in increased throughput and translates into savings on machine time. Inventory levels are lowered and further savings are made on solder materials, etc.

Space Saving

Space savings can be quite dramatic when compared to the use of discrete chip capacitors. As an example, the 0508 4-element array offers a space reduction of >40% vs. 4 x 0402 discrete capacitors and of >70% vs. 4 x 0603 discrete capacitors. (This calculation is dependent on the spacing of the discrete components.)

Increased Throughput

Assuming that there are 220 passive components placed in a mobile phone:

A reduction in the passive count to 200 (by replacing discrete components with arrays) results in an increase in throughput of approximately 9%.

A reduction of 40 placements increases throughput by 18%.

For high volume users of cap arrays using the very latest placement equipment capable of placing 10 components per second, the increase in throughput can be very significant and can have the overall effect of reducing the number of placement machines required to mount components:

If 120 million 2-element arrays or 40 million 4-element arrays were placed in a year, the requirement for placement equipment would be reduced by one machine.

During a 20Hr operational day a machine places 720K components. Over a working year of 167 days the machine can place approximately 120 million. If 2-element arrays are mounted instead of discrete components, then the number of placements is reduced by a factor of two and in the scenario where 120 million 2-element arrays are placed there is a saving of one pick and place machine.

Smaller volume users can also benefit from replacing discrete components with arrays. The total number of placements is reduced thus creating spare capacity on placement machines. This in turn generates the opportunity to increase overall production output without further investment in new equipment.

W2A (0508) Capacitor Arrays

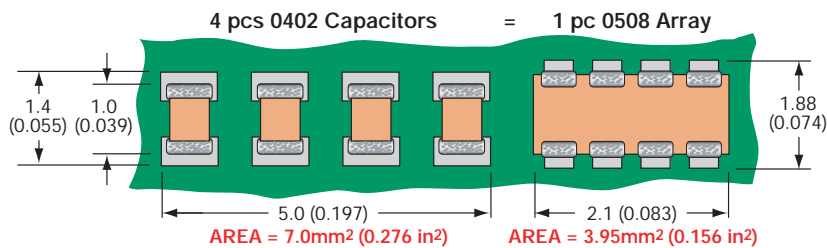

The 0508 4-element capacitor array gives a PCB space saving of over 40% vs four 0402 discretés and over 70% vs four 0603 discrete capacitors.

W3A (0612) Capacitor Arrays

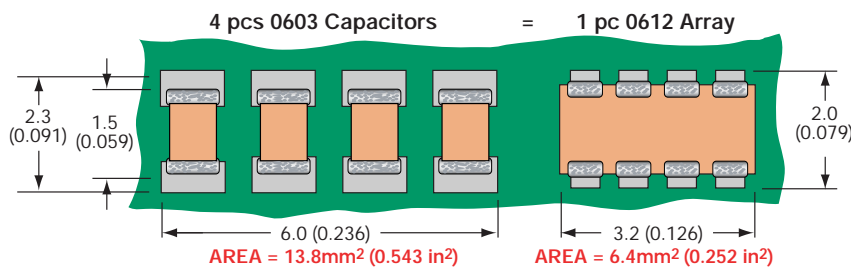

The 0612 4-element capacitor array gives a PCB space saving of over 50% vs four 0603 discretés and over 70% vs four 0805 discrete capacitors.

Capacitor Array



Capacitor Array (IPC)

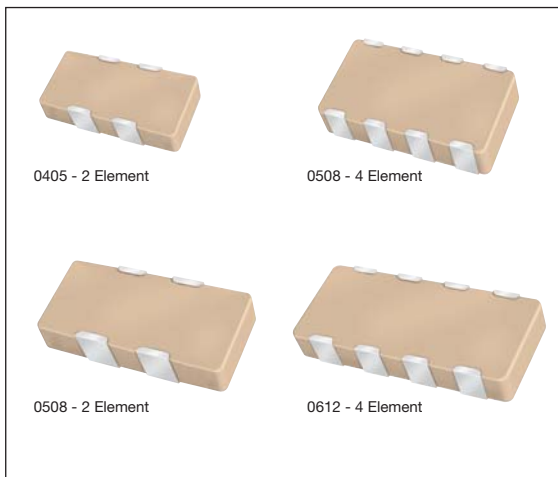

GENERAL DESCRIPTION

AVX is the market leader in the development and manufacture of capacitor arrays. The smallest array option available from AVX, the 0405 2-element device, has been an enormous success in the Telecommunications market. The array family of products also includes the 0612 4-element device as well as 0508 2-element and 4-element series, all of which have received widespread acceptance in the marketplace.

AVX capacitor arrays are available in X5R, X7R and NP0 (COG) ceramic dielectrics to cover a broad range of capacitance values. Voltage ratings from 6.3 Volts up to 100 Volts are offered. AVX also now offers a range of automotive capacitor arrays qualified to AEC-Q200 (see separate table).

Key markets for capacitor arrays are Mobile and Cordless Phones, Digital Set Top Boxes, Computer Motherboards and Peripherals as well as Automotive applications, RF Modems, Networking Products, etc.

AVX Capacitor Array - W2A41A***K
S21 Magnitude

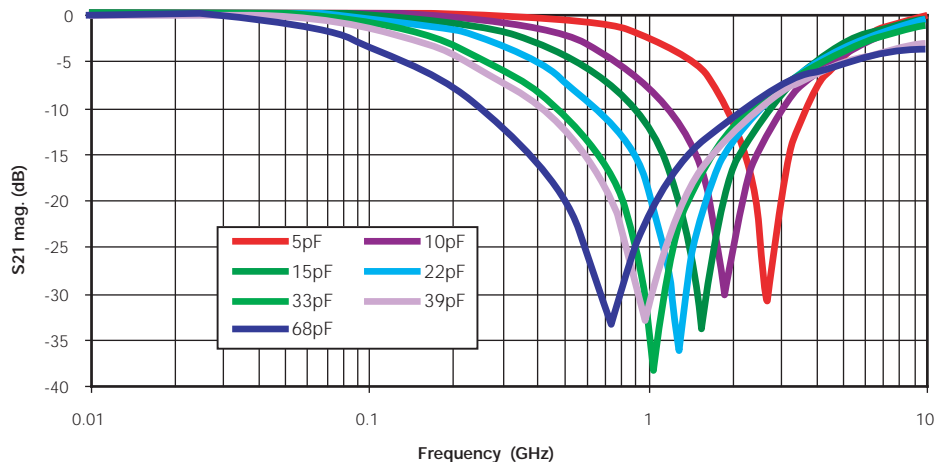

HOW TO ORDER

W	2	A	4	3	C	103	M	A	T	2A
Style W = RoHS L = SnPb	Case Size 1 = 0405 2 = 0508 3 = 0612 5 = 0306	Array	Number of Caps	Voltage 6 = 6V Z = 10V Y = 16V 3 = 25V 5 = 50V 1 = 100V	Dielectric A = NP0 C = X7R D = X5R	Capacitance Code 2 Sig Digits + Number of Zeros	Capacitance Tolerance J = ±5% K = ±10% M = ±20%	Failure Rate A = Commercial 4 = Automotive	Termination Code T = Plated Ni and Sn** Z = FLEXITERM®** B = 5% min lead X = FLEXITERM® with 5% min lead	Packaging & Quantity Code 2A = 7" Reel (4000) 4A = 13" Reel (10000) 2F = 7" Reel (1000)

Not RoHS Compliant

**RoHS compliant



NOTE: Contact factory for availability of Termination and Tolerance Options for Specific Part Numbers.

For RoHS compliant products, please select correct termination style



Capacitor Array

Capacitance Range – NP0/COG



SIZE		0405			0508				0508				0612			
# Elements		2			2				4				4			
Soldering		Reflow Only			Reflow/Wave				Reflow/Wave				Reflow/Wave			
Packaging		All Paper			All Paper				Paper/Embossed				Paper/Embossed			
Length	mm	1.00 ± 0.15			1.30 ± 0.15				1.30 ± 0.15				1.60 ± 0.150			
	(in.)	(0.039 ± 0.006)			(0.051 ± 0.006)				(0.051 ± 0.006)				(0.063 ± 0.006)			
Width	mm	1.37 ± 0.15			2.10 ± 0.15				2.10 ± 0.15				3.20 ± 0.20			
	(in.)	(0.054 ± 0.006)			(0.083 ± 0.006)				(0.083 ± 0.006)				(0.126 ± 0.008)			
Max. Thickness	mm	0.66			0.94				0.94				1.35			
	(in.)	(0.026)			(0.037)				(0.037)				(0.053)			
WVDC		16	25	50	16	25	50	100	16	25	50	100	16	25	50	100
1R0	1.0															
1R2	1.2															
1R5	1.5															
1R8	1.8															
2R2	2.2															
2R7	2.7															
3R3	3.3															
3R9	3.9															
4R7	4.7															
5R6	5.6															
6R8	6.8															
8R2	8.2															
100	10															
120	12															
150	15															
180	18															
220	22															
270	27															
330	33															
390	39															
470	47															
560	56															
680	68															
820	82															
101	100															
121	120															
151	150															
181	180															
221	220															
271	270															
331	330															
391	390															
471	470															
561	560															
681	680															
821	820															
102	1000															
122	1200															
152	1500															
182	1800															
222	2200															
272	2700															
332	3300															
392	3900															
472	4700															
562	5600															
682	6800															
822	8200															



Capacitor Array



Capacitance Range – X7R/X5R

SIZE	0306					0405					0508					0508					0612							
# Elements	4					2					2					4					4							
Soldering	Reflow Only					Reflow Only					Reflow/Wave					Reflow/Wave					Reflow/Wave							
Packaging	All Paper					All Paper					All Paper					Paper/Embossed					Paper/Embossed							
Length	1.60 ± 0.15 (0.063 ± 0.006)					1.00 ± 0.15 (0.039 ± 0.006)					1.30 ± 0.15 (0.051 ± 0.006)					1.30 ± 0.15 (0.051 ± 0.006)					1.60 ± 0.150 (0.063 ± 0.006)							
Width	0.81 ± 0.15 (0.032 ± 0.006)					1.37 ± 0.15 (0.054 ± 0.006)					2.10 ± 0.15 (0.083 ± 0.006)					2.10 ± 0.15 (0.083 ± 0.006)					3.20 ± 0.20 (0.126 ± 0.008)							
Max. Thickness	0.50 (0.020)					0.66 (0.026)					0.94 (0.037)					0.94 (0.037)					1.35 (0.053)							
WVDC	6	10	16	25		6	10	16	25	50	6	10	16	25	50	100	6	10	16	25	50	100	6	10	16	25	50	100
101	Cap	100																										
121	(pF)	120																										
151		150																										
181		180																										
221		220																										
271		270																										
331		330																										
391		390																										
471		470																										
561		560																										
681		680																										
821		820																										
102		1000																										
122		1200																										
152		1500																										
182		1800																										
222		2200																										
272		2700																										
332		3300																										
392		3900																										
472		4700																										
562		5600																										
682		6800																										
822		8200																										
103	Cap	0.010																										
123	(µF)	0.012																										
153		0.015																										
183		0.018																										
223		0.022																										
273		0.027																										
333		0.033																										
393		0.039																										
473		0.047																										
563		0.056																										
683		0.068																										
823		0.082																										
104		0.10																										
124		0.12																										
154		0.15																										
184		0.18																										
224		0.22																										
274		0.27																										
334		0.33																										
474		0.47																										
564		0.56																										
684		0.68																										
824		0.82																										
105		1.0																										
125		1.2																										
155		1.5																										
185		1.8																										
225		2.2																										
335		3.3																										
475		4.7																										
106		10																										
226		22																										
476		47																										
107		100																										

- = Currently available X7R
- = Currently available X5R
- = Under development X7R, contact factory for advance samples
- = Under development X5R, contact factory for advance samples



Automotive Capacitor Array (IPC)

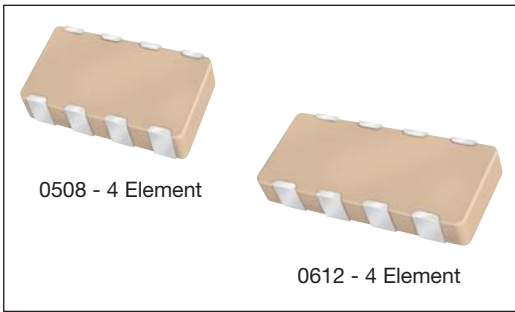

As the market leader in the development and manufacture of capacitor arrays AVX is pleased to offer a range of AEC-Q200 qualified arrays to compliment our product offering to the Automotive industry. Both the AVX 0612 and 0508 4-element capacitor array styles are qualified to the AEC-Q200 automotive specifications.

AEC-Q200 is the Automotive Industry qualification standard and a detailed qualification package is available on request.

All AVX automotive capacitor array production facilities are certified to ISO/TS 16949:2002.

HOW TO ORDER

W	3	A	4	Y	C	104	K	4	T	2A
↓	↓	↓	↓	↓	↓	↓	↓	↓	↓	↓
Style	Case Size	Array	Number of Caps	Voltage	Dielectric	Capacitance Code (In pF)	Capacitance Tolerance	Failure Rate	Terminations	Packaging & Quantity Code
W = RoHS L = SnPb	1 = 0405 2 = 0508 3 = 0612			Z = 10V Y = 16V 3 = 25V 5 = 50V 1 = 100V	A = NP0 C = X7R F = X8R	Significant Digits + Number of Zeros e.g. 10 μ F=106	*J = \pm 5% *K = \pm 10% M = \pm 20%	4 = Automotive	T = Plated Ni and Sn** Z = FLEXITERM®** B = 5% min lead X = FLEXITERM® with 5% min lead	2A = 7" Reel (4000) 4A = 13" Reel (10000) 2F = 7" Reel (1000)

**RoHS compliant

*Contact factory for availability by part number for K = \pm 10% and J = \pm 5% tolerance.

NP0/COG												
SIZE	0405	0508	0508				0612					
No. of Elements	2	2	4				4					
WVDC	50	50	16	25	50	100	16	25	50	100		
1R0	Cap 1.0											
1R2	(pF) 1.2											
1R5	1.5											
1R8	1.8											
2R2	2.2											
2R7	2.7											
3R3	3.3											
3R9	3.9											
4R7	4.7											
5R6	5.6											
6R8	6.8											
8R2	8.2											
100	10											
120	12											
150	15											
180	18											
220	22											
270	27											
330	33											
390	39											
470	47											
560	56											
680	68											
820	82											
101	100											
121	120											
151	150											
181	180											
221	220											
271	270											
331	330											
391	390											
471	470											
561	560											
681	680											
821	820											
102	1000											
122	1200											
152	1500											
182	1800											
222	2200											
272	2700											
332	3300											
392	3900											
472	4700											
562	5600											
682	6800											
822	8200											
103	Cap 0.010											
123	(μ F) 0.012											
153	0.015											
183	0.018											
223	0.022											
273	0.027											
333	0.033											
393	0.039											
473	0.047											
563	0.056											
683	0.068											
823	0.082											
104	0.10											
124	0.12											
154	0.15											
224	0.22											

X7R													X8R	
SIZE	0508				0508				0612				0405	
No. of Elements	2				4				4				2	
WVDC	16	25	50	100	16	25	50	100	10	16	25	50	100	16
101	Cap 100													
121	(pF) 120													
151	150													
181	180													
221	220													
271	270													
331	330													
391	390													
471	470													
561	560													
681	680													
821	820													
102	1000													
122	1200													
152	1500													
182	1800													
222	2200													
272	2700													
332	3300													
392	3900													
472	4700													
562	5600													
682	6800													
822	8200													
103	Cap 0.010													
123	(μ F) 0.012													
153	0.015													
183	0.018													
223	0.022													
273	0.027													
333	0.033													
393	0.039													
473	0.047													
563	0.056													
683	0.068													
823	0.082													
104	0.10													
124	0.12													
154	0.15													
224	0.22													

= X7R
 = X8R
 = Under development

Not RoHS Compliant

= NP0/COG
 = Under development



For RoHS compliant products, please select correct termination style.



PART & PAD LAYOUT DIMENSIONS

millimeters (inches)

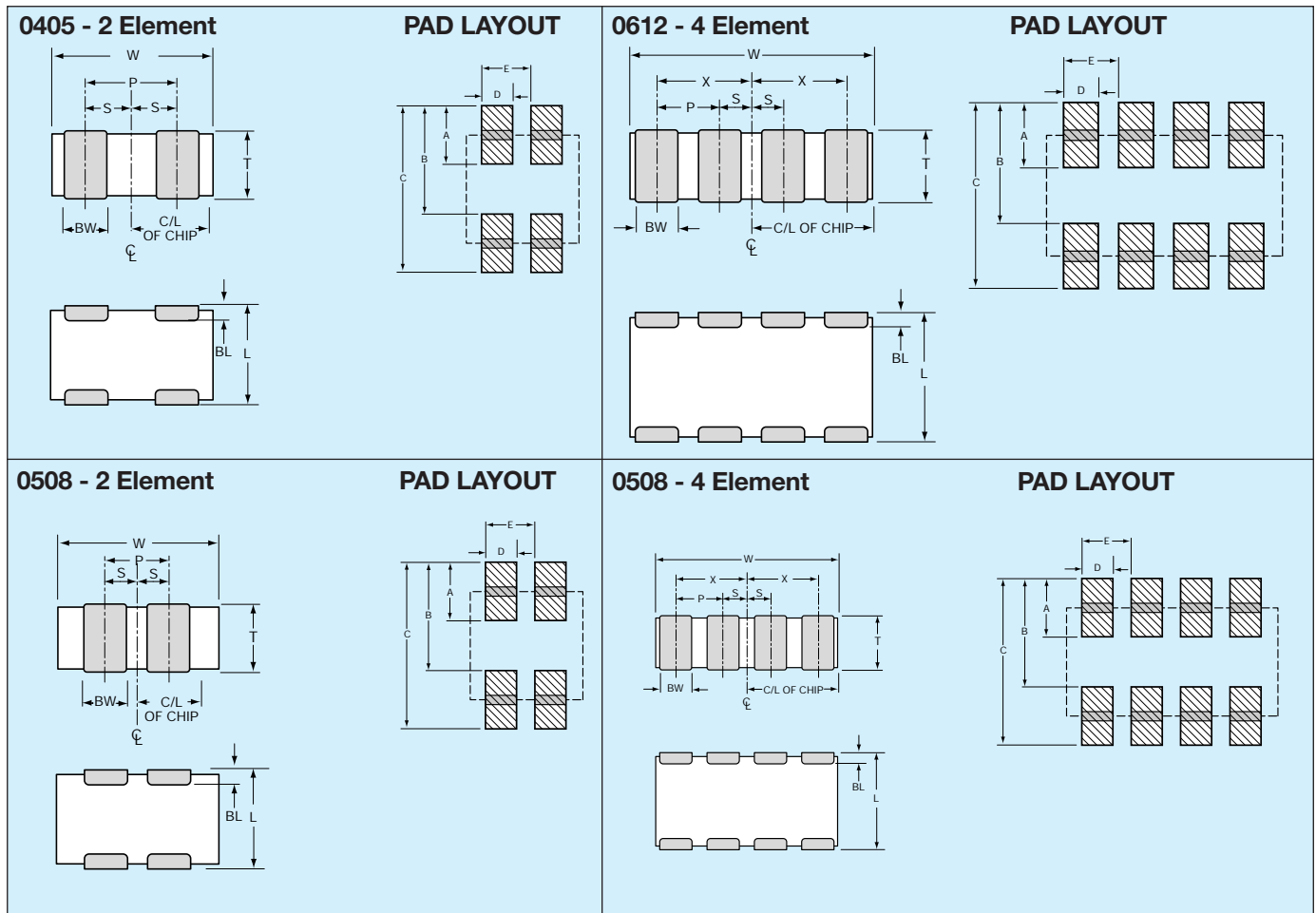

PART DIMENSIONS

0405 - 2 Element

L	W	T	BW	BL	P	S
1.00 ± 0.15 (0.039 ± 0.006)	1.37 ± 0.15 (0.054 ± 0.006)	0.66 MAX (0.026 MAX)	0.36 ± 0.10 (0.014 ± 0.004)	0.20 ± 0.10 (0.008 ± 0.004)	0.64 REF (0.025 REF)	0.32 ± 0.10 (0.013 ± 0.004)

0508 - 2 Element

L	W	T	BW	BL	P	S
1.30 ± 0.15 (0.051 ± 0.006)	2.10 ± 0.15 (0.083 ± 0.006)	0.94 MAX (0.037 MAX)	0.43 ± 0.10 (0.017 ± 0.004)	0.33 ± 0.08 (0.013 ± 0.003)	1.00 REF (0.039 REF)	0.50 ± 0.10 (0.020 ± 0.004)

0508 - 4 Element

L	W	T	BW	BL	P	X	S
1.30 ± 0.15 (0.051 ± 0.006)	2.10 ± 0.15 (0.083 ± 0.006)	0.94 MAX (0.037 MAX)	0.25 ± 0.06 (0.010 ± 0.003)	0.20 ± 0.08 (0.008 ± 0.003)	0.50 REF (0.020 REF)	0.75 ± 0.10 (0.030 ± 0.004)	0.25 ± 0.10 (0.010 ± 0.004)

0612 - 4 Element

L	W	T	BW	BL	P	X	S
1.60 ± 0.20 (0.063 ± 0.008)	3.20 ± 0.20 (0.126 ± 0.008)	1.35 MAX (0.053 MAX)	0.41 ± 0.10 (0.016 ± 0.004)	0.18 ± 0.08 (0.007 ± 0.003)	0.76 REF (0.030 REF)	1.14 ± 0.10 (0.045 ± 0.004)	0.38 ± 0.10 (0.015 ± 0.004)

PAD LAYOUT DIMENSIONS

0405 - 2 Element

A	B	C	D	E
0.46 (0.018)	0.74 (0.029)	1.20 (0.047)	0.30 (0.012)	0.64 (0.025)

0508 - 2 Element

A	B	C	D	E
0.68 (0.027)	1.32 (0.052)	2.00 (0.079)	0.46 (0.018)	1.00 (0.039)

0508 - 4 Element

A	B	C	D	E
0.56 (0.022)	1.32 (0.052)	1.88 (0.074)	0.30 (0.012)	0.50 (0.020)

0612 - 4 Element

A	B	C	D	E
0.89 (0.035)	1.65 (0.065)	2.54 (0.100)	0.46 (0.018)	0.76 (0.030)

Introduction

The signal integrity characteristics of a Power Delivery Network (PDN) are becoming critical aspects of board level and semiconductor package designs due to higher operating frequencies, larger power demands, and the ever shrinking lower and upper voltage limits around low operating voltages. These power system challenges are coming from mainstream designs with operating frequencies of 300MHz or greater, modest ICs with power demand of 15 watts or more, and operating voltages below 3 volts.

The classic PDN topology is comprised of a series of capacitor stages. Figure 1 is an example of this architecture with multiple capacitor stages.

An ideal capacitor can transfer all its stored energy to a load instantly. A real capacitor has parasitics that prevent instantaneous transfer of a capacitor's stored energy. The true nature of a capacitor can be modeled as an RLC equivalent circuit. For most simulation purposes, it is possible to model the characteristics of a real capacitor with one

capacitor, one resistor, and one inductor. The RLC values in this model are commonly referred to as equivalent series capacitance (ESC), equivalent series resistance (ESR), and equivalent series inductance (ESL).

The ESL of a capacitor determines the speed of energy transfer to a load. The lower the ESL of a capacitor, the faster that energy can be transferred to a load. Historically, there has been a tradeoff between energy storage (capacitance) and inductance (speed of energy delivery). Low ESL devices typically have low capacitance. Likewise, higher capacitance devices typically have higher ESLs. This tradeoff between ESL (speed of energy delivery) and capacitance (energy storage) drives the PDN design topology that places the fastest low ESL capacitors as close to the load as possible. Low Inductance MLCCs are found on semiconductor packages and on boards as close as possible to the load.

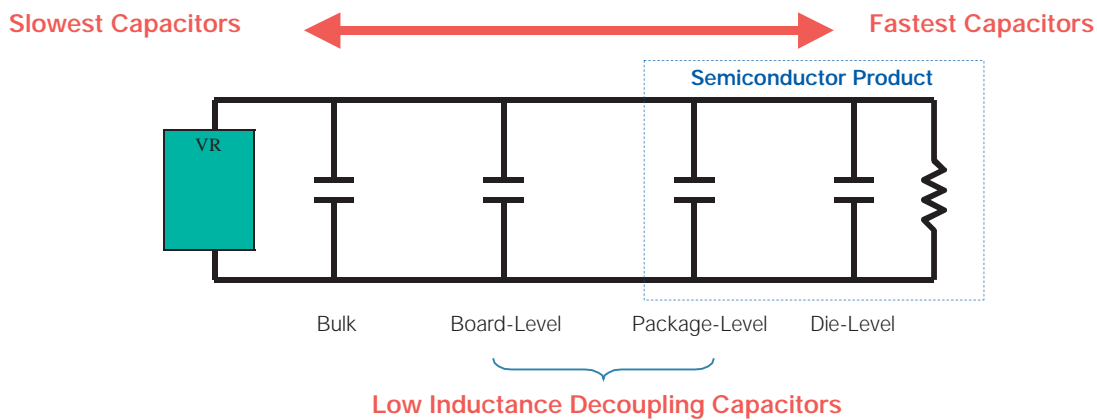

Figure 1 Classic Power Delivery Network (PDN) Architecture

LOW INDUCTANCE CHIP CAPACITORS

The key physical characteristic determining equivalent series inductance (ESL) of a capacitor is the size of the current loop it creates. The smaller the current loop, the lower the ESL. A standard surface mount MLCC is rectangular in shape with electrical terminations on its shorter sides. A Low Inductance Chip Capacitor (LICC) sometimes referred to as Reverse Geometry Capacitor (RGC) has its terminations on the longer side of its rectangular shape.

When the distance between terminations is reduced, the size of the current loop is reduced. Since the size of the current loop is the primary driver of inductance, an 0306 with a smaller current loop has significantly lower ESL than an 0603. The reduction in ESL varies by EIA size, however, ESL is typically reduced 60% or more with an LICC versus a standard MLCC.

INTERDIGITATED CAPACITORS

The size of a current loop has the greatest impact on the ESL characteristics of a surface mount capacitor. There is a secondary method for decreasing the ESL of a capacitor. This secondary method uses adjacent opposing current loops to reduce ESL. The InterDigitated Capacitor (IDC) utilizes both primary and secondary methods of reducing inductance. The IDC architecture shrinks the distance between terminations to minimize the current loop size, then further reduces inductance by creating adjacent opposing current loops.

An IDC is one single capacitor with an internal structure that has been optimized for low ESL. Similar to standard MLCC versus LICCs, the reduction in ESL varies by EIA case size. Typically, for the same EIA size, an IDC delivers an ESL that is at least 80% lower than an MLCC.

Introduction

LAND GRID ARRAY (LGA) CAPACITORS

Land Grid Array (LGA) capacitors are based on the first Low ESL MLCC technology created to specifically address the design needs of current day Power Delivery Networks (PDNs). This is the 3rd low inductance capacitor technology developed by AVX. LGA technology provides engineers with new options. The LGA internal structure and manufacturing technology eliminates the historic need for a device to be physically small to create small current loops to minimize inductance.

The first family of LGA products are 2 terminal devices. A 2 terminal 0306 LGA delivers ESL performance that is equal to or better than an 0306 8 terminal IDC. The 2 terminal 0805 LGA delivers ESL performance that approaches the 0508 8 terminal IDC. New designs that would have used 8 terminal IDCs are moving to 2 terminal LGAs because the layout is easier for a 2 terminal device and manufacturing yield is better for a 2 terminal LGA versus an 8 terminal IDC.

LGA technology is also used in a 4 terminal family of products that AVX is sampling and will formerly introduce in 2008. Beyond 2008, there are new multi-terminal LGA product families that will provide even more attractive options for PDN designers.

LOW INDUCTANCE CHIP ARRAYS (LICA®)

The LICA® product family is the result of a joint development effort between AVX and IBM to develop a high performance MLCC family of decoupling capacitors. LICA was introduced in the 1980s and remains the leading choice of designers in high performance semiconductor packages and high reliability board level decoupling applications.

LICA® products are used in 99.999% uptime semiconductor package applications on both ceramic and organic substrates. The C4 solder ball termination option is the perfect compliment to flip-chip packaging technology. Mainframe class CPUs, ultimate performance multi-chip modules, and communications systems that must have the reliability of 5 9's use LICA®.

LICA® products with either Sn/Pb or Pb-free solder balls are used for decoupling in high reliability military and aerospace applications. These LICA® devices are used for decoupling of large pin count FPGAs, ASICs, CPUs, and other high power ICs with low operating voltages.

When high reliability decoupling applications require the very lowest ESL capacitors, LICA® products are the best option.

470 nF 0306 Impedance Comparison

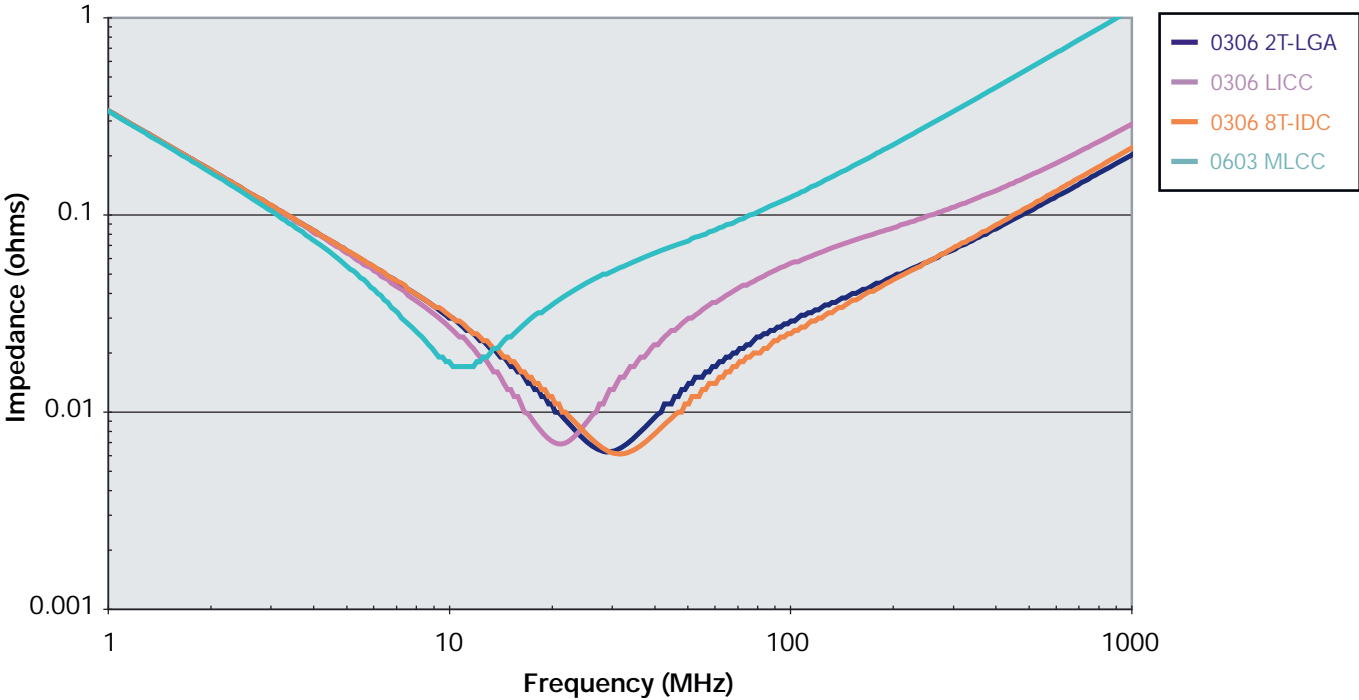

Figure 2 MLCC, LICC, IDC, and LGA technologies deliver different levels of equivalent series inductance (ESL).

Low Inductance Capacitors (RoHS)



0612/0508/0306/0204 LICC (Low Inductance Chip Capacitors)

GENERAL DESCRIPTION

The key physical characteristic determining equivalent series inductance (ESL) of a capacitor is the size of the current loop it creates. The smaller the current loop, the lower the ESL.

A standard surface mount MLCC is rectangular in shape with electrical terminations on its shorter sides. A Low Inductance Chip Capacitor (LICC) sometimes referred to as Reverse Geometry Capacitor (RGC) has its terminations on the longer sides of its rectangular shape. The image on the right shows the termination differences between an MLCC and an LICC.

When the distance between terminations is reduced, the size of the current loop is reduced. Since the size of the current loop is the primary driver of inductance, an 0306 with a smaller current loop has significantly lower ESL than an 0603. The reduction in ESL varies by EIA size, however, ESL is typically reduced 60% or more with an LICC versus a standard MLCC.

AVX LICC products are available with a lead-free finish of plated Nickel/Tin.

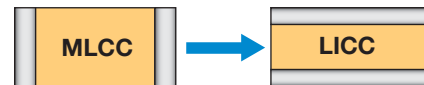
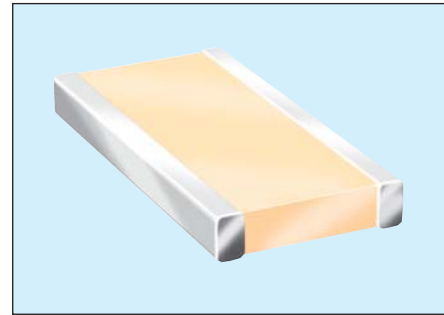

PERFORMANCE CHARACTERISTICS

Capacitance Tolerances	K = $\pm 10\%$; M = $\pm 20\%$
Operation Temperature Range	X7R = -55°C to $+125^{\circ}\text{C}$ X5R = -55°C to $+85^{\circ}\text{C}$ X7S = -55°C to $+125^{\circ}\text{C}$
Temperature Coefficient	X7R, X5R = $\pm 15\%$; X7S = $\pm 22\%$
Voltage Ratings	4, 6.3, 10, 16, 25 VDC
Dissipation Factor	4V, 6.3V = 6.5% max; 10V = 5.0% max; 16V = 3.5% max; 25V = 3.0% max
Insulation Resistance (@+25°C, RVDC)	100,000M Ω min, or 1,000M Ω per μF min., whichever is less



HOW TO ORDER

0612

Size
0204
0306
0508
0612

Z

Voltage
4 = 4V
6 = 6.3V
Z = 10V
Y = 16V
3 = 25V
5 = 50V

D

Dielectric
C = X7R
D = X5R
W = X6S
Z = X7S

105

Capacitance Code (In pF)
2 Sig. Digits +
Number of Zeros

M

Capacitance Tolerance
K = $\pm 10\%$
M = $\pm 20\%$

A

Failure Rate
A = N/A

T

Terminations
T = Plated Ni
and Sn

2

Packaging Available
2 = 7" Reel
4 = 13" Reel

A*

Thickness
Thickness
mm (in)
0.35 (0.014)
0.56 (0.022)
0.61 (0.024)
0.76 (0.030)
1.02 (0.040)
1.27 (0.050)

NOTE: Contact factory for availability of Termination and Tolerance Options for Specific Part Numbers.

TYPICAL IMPEDANCE CHARACTERISTICS

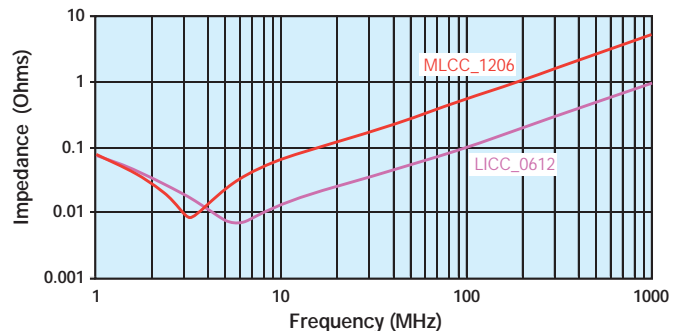
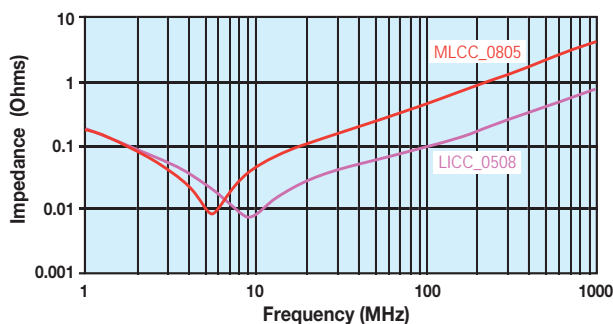

Low Inductance Capacitors (RoHS)



0612/0508/0306/0204 LICC (Low Inductance Chip Capacitors)

SIZE	0204				0306					0508					0612														
Packaging															Embossed					Embossed					Embossed				
Length mm (in.)															0.81 ± 0.15 (0.032 ± 0.006)					1.27 ± 0.25 (0.050 ± 0.010)					1.60 ± 0.25 (0.063 ± 0.010)				
Width mm (in.)															1.60 ± 0.15 (0.063 ± 0.006)					2.00 ± 0.25 (0.080 ± 0.010)					3.20 ± 0.25 (0.126 ± 0.010)				
WVDC	4	6.3	10	16	4	6.3	10	16	25	50	6.3	10	16	25	50	6.3	10	16	25	50									
CAP 0.001 (µF)																													
0.0022																													
0.0047																													
0.010																													
0.015																													
0.022																													
0.047																													
0.068																													
0.10																													
0.15																													
0.22																													
0.47																													
0.68																													
1.0																													
1.5																													
2.2																													
3.3																													
4.7																													
10																													

PHYSICAL DIMENSIONS AND PAD LAYOUT

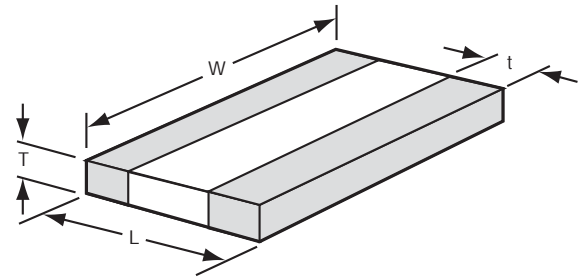

PHYSICAL CHIP DIMENSIONS mm (in)

	L	W	t
0612	1.60 ± 0.25 (0.063 ± 0.010)	3.20 ± 0.25 (0.126 ± 0.010)	0.13 min. (0.005 min.)
0508	1.27 ± 0.25 (0.050 ± 0.010)	2.00 ± 0.25 (0.080 ± 0.010)	0.13 min. (0.005 min.)
0306	0.81 ± 0.15 (0.032 ± 0.006)	1.60 ± 0.15 (0.063 ± 0.006)	0.13 min. (0.005 min.)
0204	0.50 ± 0.05 (0.020 ± 0.002)	1.00 ± 0.05 (0.040 ± 0.002)	0.18 ± 0.08 (0.007 ± 0.003)

T - See Range Chart for Thickness and Codes

PAD LAYOUT DIMENSIONS mm (in)

	A	B	C
0612	0.76 (0.030)	3.05 (0.120)	.635 (0.025)
0508	0.51 (0.020)	2.03 (0.080)	0.51 (0.020)
0306	0.31 (0.012)	1.52 (0.060)	0.51 (0.020)
0204			

Solid = X7R		Diagonal lines = X5R		Vertical lines = X7S		Horizontal lines = X6S	
mm (in.)		mm (in.)		mm (in.)		mm (in.)	
0204		0306		0508		0612	
Code	Thickness	Code	Thickness	Code	Thickness	Code	Thickness
C	0.35 (0.014)	A	0.61 (0.024)	S	0.56 (0.022)	S	0.56 (0.022)
				V	0.76 (0.030)	V	0.76 (0.030)
				A	1.02 (0.040)	W	1.02 (0.040)
						A	1.27 (0.050)

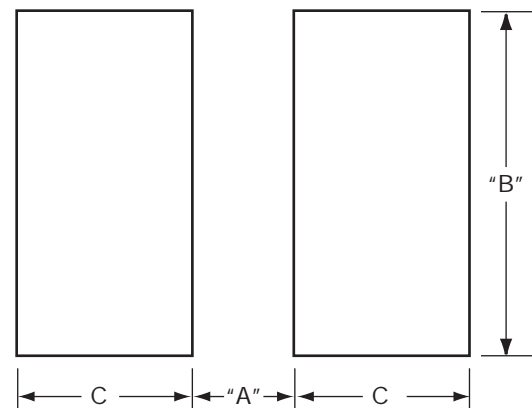

Low Inductance Capacitors (SnPb)



0612/0508/0306/0204 Tin Lead Termination "B"

GENERAL DESCRIPTION

The key physical characteristic determining equivalent series inductance (ESL) of a capacitor is the size of the current loop it creates. The smaller the current loop, the lower the ESL.

A standard surface mount MLCC is rectangular in shape with electrical terminations on its shorter sides. A Low Inductance Chip Capacitor (LICC) sometimes referred to as Reverse Geometry Capacitor (RGC) has its terminations on the longer sides of its rectangular shape. The image on the right shows the termination differences between an MLCC and an LICC.

When the distance between terminations is reduced, the size of the current loop is reduced. Since the size of the current loop is the primary driver of inductance, an 0306 with a smaller current loop has significantly lower ESL than an 0603. The reduction in ESL varies by EIA size, however, ESL is typically reduced 60% or more with an LICC versus a standard MLCC.

AVX LICC products are available with a lead termination for high reliability military and aerospace applications that must avoid tin whisker reliability issues.

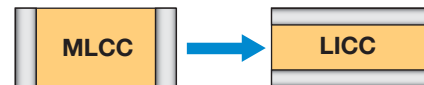
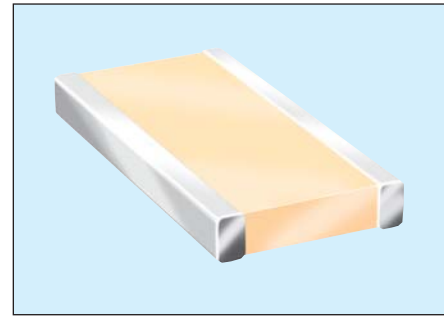

PERFORMANCE CHARACTERISTICS

Capacitance Tolerances	K = $\pm 10\%$; M = $\pm 20\%$
Operation Temperature Range	X7R = -55°C to $+125^{\circ}\text{C}$ X5R = -55°C to $+85^{\circ}\text{C}$ X7S = -55°C to $+125^{\circ}\text{C}$
Temperature Coefficient	X7R, X5R = $\pm 15\%$; X7S = $\pm 22\%$
Voltage Ratings	4, 6.3, 10, 16, 25 VDC
Dissipation Factor	4V, 6.3V = 6.5% max; 10V = 5.0% max; 16V = 3.5% max; 25V = 3.0% max
Insulation Resistance (@+25°C, RVDC)	100,000M Ω min, or 1,000M Ω per μF min., whichever is less

Not RoHS Compliant

HOW TO ORDER

LD18	Z	D	105	M	A	B	2	A*
Size	Voltage	Dielectric	Capacitance Code (In pF)	Capacitance Tolerance	Failure Rate	Terminations	Packaging Available	Thickness
LD15 = 0204 LD16 = 0306 LD17 = 0508 LD18 = 0612	4 = 4V 6 = 6.3V Z = 10V Y = 16V 3 = 25V 5 = 50V	C = X7R D = X5R W = X6S	2 Sig. Digits + Number of Zeros	K = $\pm 10\%$ M = $\pm 20\%$	A = N/A	B = 5% min lead	2 = 7" Reel 4 = 13" Reel	mm (in) 0.35 (0.014) 0.56 (0.022) 0.61 (0.024) 0.76 (0.030) 1.02 (0.040) 1.27 (0.050)

NOTE: Contact factory for availability of Termination and Tolerance Options for Specific Part Numbers.

TYPICAL IMPEDANCE CHARACTERISTICS

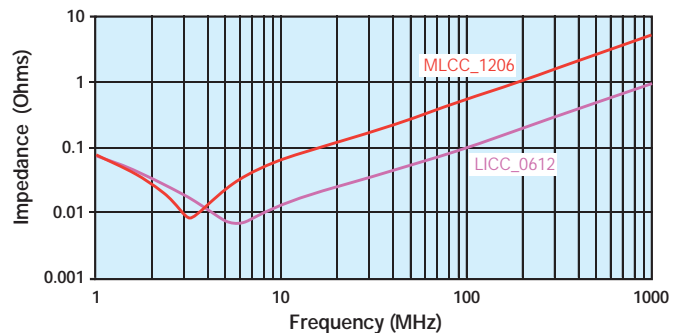
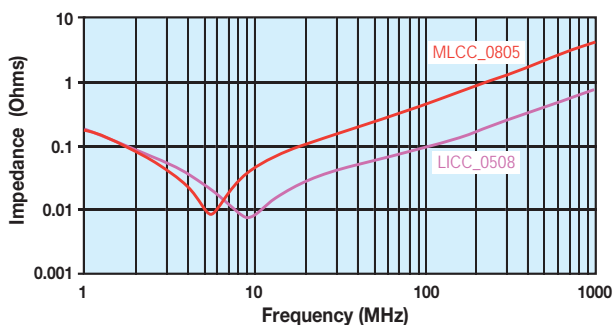

Low Inductance Capacitors (SnPb)



0612/0508/0306/0204 Tin Lead Termination "B"

PREFERRED SIZES ARE SHADED

SIZE	LD15				LD16				LD17				LD18						
Soldering					Reflow Only				Reflow Only				Reflow/Wave						
Packaging					All Paper				All Paper				Paper/Embossed						
(L) Length mm (in.)					0.81 ± 0.15 (0.032 ± 0.006)				1.27 ± 0.25 (0.050 ± 0.010)				1.60 ± 0.25 (0.063 ± 0.010)						
(W) Width mm (in.)					1.60 ± 0.15 (0.063 ± 0.006)				2.00 ± 0.25 (0.080 ± 0.010)				3.20 ± 0.25 (0.126 ± 0.010)						
WVDC	4	6.3	10	16	6.3	10	16	25	50	6.3	10	16	25	50	6.3	10	16	25	50
Cap (pF)	1000				A	A	A	A		S	S	S	S	V	S	S	S	S	V
	2200				A	A	A	A		S	S	S	S	V	S	S	S	S	V
	4700				A	A	A	A		S	S	S	S	V	S	S	S	S	V
Cap (µF)	0.010				A	A	A	A		S	S	S	S	V	S	S	S	S	V
	0.015				A	A	A	A		S	S	S	S	V	S	S	S	S	V
	0.022				A	A	A	A		S	S	S	S	V	S	S	S	S	V
	0.047				A	A	A		S	S	S	V	A		S	S	S	S	V
	0.068				A	A	A		S	S	S	A	A		S	S	S	V	W
	0.10	C	C		A	A	A		S	S	V	A	A		S	S	S	V	W
	0.15				A	A			S	S	V			S	S	S	W	W	
	0.22				A	A			S	S	V	A		S	S	V			
	0.47								V	V	A			S	S	V			
	0.68								A	A				V	V	W			
	1.0								A	A				V	V	W			
	1.5								A	A				W	W	A			
	2.2													A	A				
	3.3																		
	4.7																		
	10																		
WVDC	4	6.3	10	16	6.3	10	16	25	50	6.3	10	16	25	50	6.3	10	16	25	50
SIZE	0204				0306				0508				0612						

Solid = X7R	= X5R	= X7S	= X6S
mm (in.)	mm (in.)	mm (in.)	mm (in.)
LD15 - 0204	LD16 - 0306	LD17 - 0508	LD18 - 0612
Code Thickness	Code Thickness	Code Thickness	Code Thickness
C 0.35 (0.014)	A 0.61 (0.024)	S 0.56 (0.022) V 0.76 (0.030) A 1.02 (0.040)	S 0.56 (0.022) V 0.76 (0.030) W 1.02 (0.040) A 1.27 (0.050)

PHYSICAL DIMENSIONS AND PAD LAYOUT

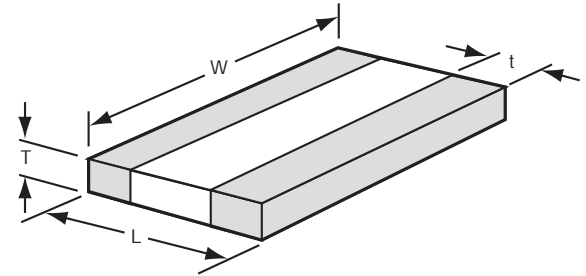

PHYSICAL CHIP DIMENSIONS mm (in)

	L	W	t
0612	1.60 ± 0.25 (0.063 ± 0.010)	3.20 ± 0.25 (0.126 ± 0.010)	0.13 min. (0.005 min.)
0508	1.27 ± 0.25 (0.050 ± 0.010)	2.00 ± 0.25 (0.080 ± 0.010)	0.13 min. (0.005 min.)
0306	0.81 ± 0.15 (0.032 ± 0.006)	1.60 ± 0.15 (0.063 ± 0.006)	0.13 min. (0.005 min.)
0204	0.50 ± 0.05 (0.020 ± 0.002)	1.00 ± 0.05 (0.040 ± 0.002)	0.18 ± 0.08 (0.007 ± 0.003)

T - See Range Chart for Thickness and Codes

PAD LAYOUT DIMENSIONS mm (in)

	A	B	C
0612	0.76 (0.030)	3.05 (0.120)	.635 (0.025)
0508	0.51 (0.020)	2.03 (0.080)	0.51 (0.020)
0306	0.31 (0.012)	1.52 (0.060)	0.51 (0.020)
0204			

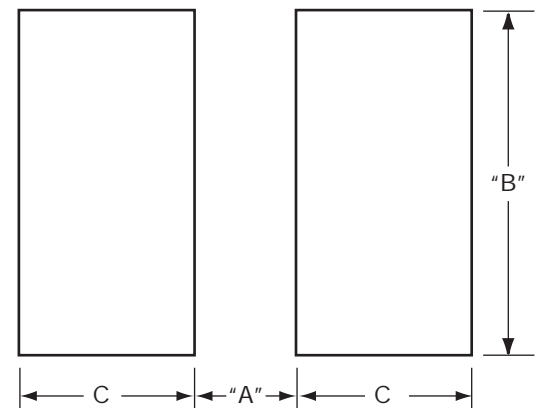

IDC Low Inductance Capacitors (RoHS)

0306/0612/0508 IDC (InterDigitated Capacitors)

GENERAL DESCRIPTION

Inter-Digitated Capacitors (IDCs) are used for both semiconductor package and board level decoupling. The equivalent series inductance (ESL) of a single capacitor or an array of capacitors in parallel determines the response time of a Power Delivery Network (PDN). The lower the ESL of a PDN, the faster the response time. A designer can use many standard MLCCs in parallel to reduce ESL or a low ESL Inter-Digitated Capacitor (IDC) device. These IDC devices are available in versions with a maximum height of 0.95mm or 0.55mm.

IDCs are typically used on packages of semiconductor products with power levels of 15 watts or greater. Inter-Digitated Capacitors are used on CPU, GPU, ASIC, and ASSP devices produced on 0.13μ, 90nm, 65nm, and 45nm processes. IDC devices are used on both ceramic and organic package substrates. These low ESL surface mount capacitors can be placed on the bottom side or the top side of a package substrate. The low profile 0.55mm maximum height IDCs can easily be used on the bottom side of BGA packages or on the die side of packages under a heat spreader.

IDCs are used for board level decoupling of systems with speeds of 300MHz or greater. Low ESL IDCs free up valuable board space by reducing the number of capacitors required versus standard MLCCs. There are additional benefits to reducing the number of capacitors beyond saving board space including higher reliability from a reduction in the number of components and lower placement costs based on the need for fewer capacitors.

The Inter-Digitated Capacitor (IDC) technology was developed by AVX. This is the second family of Low Inductance MLCC products created by AVX. IDCs are a cost effective alternative to AVX's first generation low ESL family for high-reliability applications known as LICA (Low Inductance Chip Array).

AVX IDC products are available with a lead-free finish of plated Nickel/Tin.

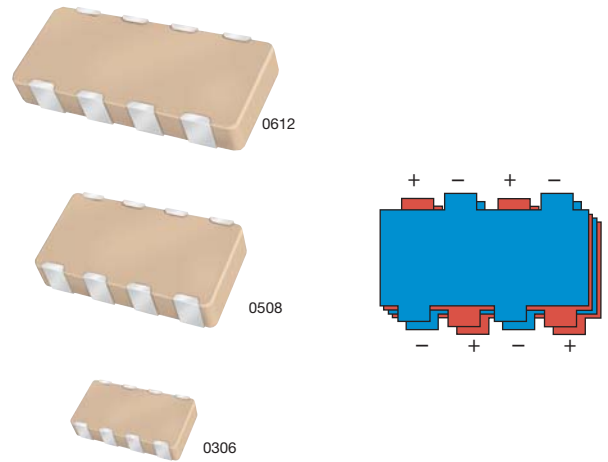

TYPICAL IMPEDANCE

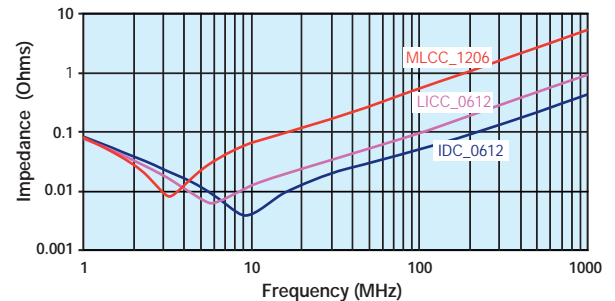

HOW TO ORDER

W	3	L	1	6	D	225	M	A	T	3	A
Style	IDC Case Size	Low Inductance	Number of Terminals	Voltage	Dielectric	Capacitance Code (In pF)	Capacitance Tolerance	Failure Rate	Termination	Packaging	Thickness
	2 = 0508 3 = 0612 4 = 0306		1 = 8 Terminals	4 = 4V 6 = 6.3V Z = 10V Y = 16V 3 = 25V	C = X7R D = X5R Z = X7S	2 Sig. Digits + Number of Zeros	M = ±20%	A = N/A	T = Plated Ni and Sn	Available 1=7" Reel 3=13" Reel	Max. Thickness mm (in.) A=Standard S=0.55 (0.022)

NOTE: Contact factory for availability of Termination and Tolerance Options for Specific Part Numbers.

PERFORMANCE CHARACTERISTICS

Capacitance Tolerance	±20% Preferred
Operation Temperature Range	X7R = -55°C to +125°C X5R = -55°C to +85°C X7S = -55°C to +125°C
Temperature Coefficient	±15% (OVDC), ±22% (X7S)
Voltage Ratings	4, 6.3, 10, 16, 25 VDC
Dissipation Factor	≤ 6.3V = 6.5% max; 10V = 5.0% max; ≥ 16V = 3.5% max
Insulation Resistance (@+25°C, RVDC)	100,000MΩ min, or 1,000MΩ per μF min., whichever is less

Dielectric Strength	No problems observed after 2.5 x RVDC for 5 seconds at 50mA max current
CTE (ppm/C)	12.0
Thermal Conductivity	4-5W/M K
Terminations Available	Plated Nickel and Solder

IDC Low Inductance Capacitors (RoHS)

0306/0612/0508 IDC (InterDigitated Capacitors)

SIZE	0306		Thin 0508					0508					Thin 0612				0612					THICK 0612							
Max. Thickness	0.55 (0.022)		0.55 (0.022)					0.95 (0.037)					0.55 (0.022)				0.95 (0.037)					1.22 (0.048)							
WVDC	4	6.3	4	6.3	10	16	25	4	6.3	10	16	25	4	6.3	10	16	4	6.3	10	16	25	4	6.3	10	16	4	6.3	10	16
Cap (μF)	0.010																												
	0.022																												
	0.033																												
	0.047																												
	0.068																												
	0.10																												
	0.22																												
	0.33																												
	0.47																												
	0.68																												
	1.0																												
	1.5																												
	2.2																												
	3.3																												

PHYSICAL DIMENSIONS AND PAD LAYOUT

Consult factory for additional requirements

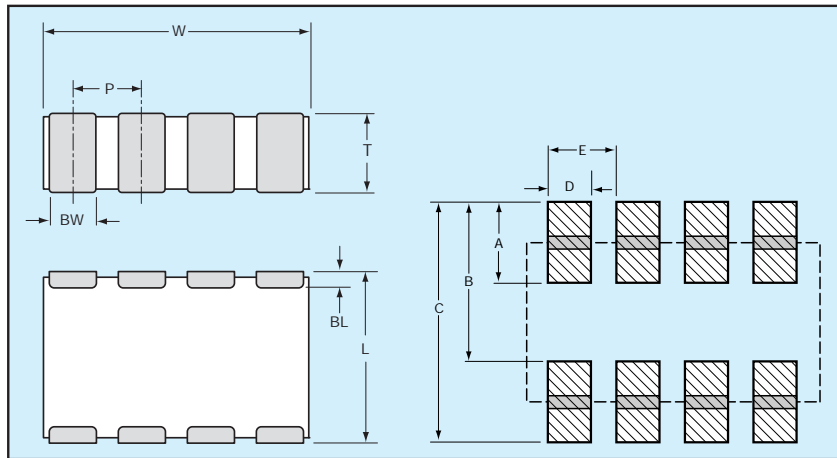

- = X7R
- = X5R
- = X7S

PHYSICAL CHIP DIMENSIONS millimeters (inches)

SIZE	W	L	BW	BL	P
0306	1.60 ± 0.20 (0.063 ± 0.008)	0.82 ± 0.10 (0.032 ± 0.006)	0.25 ± 0.10 (0.010 ± 0.004)	0.20 ± 0.10 (0.008 ± 0.004)	0.40 ± 0.05 (0.015 ± 0.002)
0508	2.03 ± 0.20 (0.080 ± 0.008)	1.27 ± 0.20 (0.050 ± 0.008)	0.30 ± 0.10 (0.012 ± 0.004)	0.25 ± 0.15 (0.010 ± 0.006)	0.50 ± 0.05 (0.020 ± 0.002)
0612	3.20 ± 0.20 (0.126 ± 0.008)	1.60 ± 0.20 (0.063 ± 0.008)	0.50 ± 0.10 (0.020 ± 0.004)	0.25 ± 0.15 (0.010 ± 0.006)	0.80 ± 0.10 (0.031 ± 0.004)

PAD LAYOUT DIMENSIONS

SIZE	A	B	C	D	E
0306	0.38 (0.015)	0.89 (0.035)	1.27 (0.050)	0.20 (0.008)	0.40 (0.015)
0508	0.64 (0.025)	1.27 (0.050)	1.91 (0.075)	0.28 (0.011)	0.50 (0.020)
0612	0.89 (0.035)	1.65 (0.065)	2.54 (0.100)	0.45 (0.018)	0.80 (0.031)

IDC Low Inductance Capacitors (SnPb)

0306/0612/0508 IDC with Sn/Pb Termination

GENERAL DESCRIPTION

Inter-Digitated Capacitors (IDCs) are used for both semiconductor package and board level decoupling. The equivalent series inductance (ESL) of a single capacitor or an array of capacitors in parallel determines the response time of a Power Delivery Network (PDN). The lower the ESL of a PDN, the faster the response time. A designer can use many standard MLCCs in parallel to reduce ESL or a low ESL Inter-Digitated Capacitor (IDC) device. These IDC devices are available in versions with a maximum height of 0.95mm or 0.55mm.

IDCs are typically used on packages of semiconductor products with power levels of 15 watts or greater. Inter-Digitated Capacitors are used on CPU, GPU, ASIC, and ASSP devices produced on 0.13 μ m, 90nm, 65nm, and 45nm processes. IDC devices are used on both ceramic and organic package substrates. These low ESL surface mount capacitors can be placed on the bottom side or the top side of a package substrate. The low profile 0.55mm maximum height IDCs can easily be used on the bottom side of BGA packages or on the die side of packages under a heat spreader.

IDCs are used for board level decoupling of systems with speeds of 300MHz or greater. Low ESL IDCs free up valuable board space by reducing the number of capacitors required versus standard MLCCs. There are additional benefits to reducing the number of capacitors beyond saving board space including higher reliability from a reduction in the number of components and lower placement costs based on the need for fewer capacitors.

The Inter-Digitated Capacitor (IDC) technology was developed by AVX. This is the second family of Low Inductance MLCC products created by AVX. IDCs are a cost effective alternative to AVX's first generation low ESL family for high-reliability applications known as LICA (Low Inductance Chip Array).

AVX IDC products are available with a lead termination for high reliability military and aerospace applications that must avoid tin whisker reliability issues.

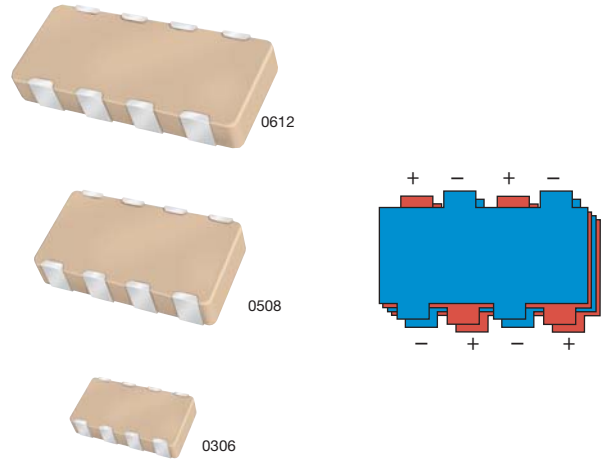

TYPICAL IMPEDANCE

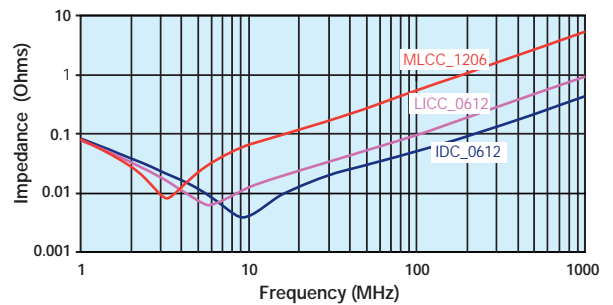

Not RoHS Compliant

HOW TO ORDER

L	3	L	1	6	D	225	M	A	B	3	A
Style	IDC Case Size	Low Inductance	Number of Terminals	Voltage	Dielectric	Capacitance Code (In pF)	Capacitance Tolerance	Failure Rate	Termination	Packaging Available	Thickness
	2 = 0508 3 = 0612 4 = 0306		1 = 8 Terminals	4 = 4V 6 = 6.3V Z = 10V Y = 16V 3 = 25V	C = X7R D = X5R Z = X7S	2 Sig. Digits + Number of Zeros	M = $\pm 20\%$	A = N/A	B = 5% min. Lead	1=7" Reel 3=13" Reel	Max. Thickness mm (in.) A=Standard S=0.55 (0.022)

NOTE: Contact factory for availability of Termination and Tolerance Options for Specific Part Numbers.

PERFORMANCE CHARACTERISTICS

Capacitance Tolerance	$\pm 20\%$ Preferred
Operation Temperature Range	X7R = -55°C to +125°C X5R = -55°C to +85°C X7S = -55°C to +125°C
Temperature Coefficient	$\pm 15\%$ (0VDC), $\pm 22\%$ (X7S)
Voltage Ratings	4, 6.3, 10, 16, 25 VDC
Dissipation Factor	$\leq 6.3V = 6.5\%$ max; 10V = 5.0% max; $\geq 16V = 3.5\%$ max
Insulation Resistance (@+25°C, RVDC)	100,000M Ω min, or 1,000M Ω per μ F min., whichever is less

Dielectric Strength	No problems observed after 2.5 x RVDC for 5 seconds at 50mA max current
CTE (ppm/C)	12.0
Thermal Conductivity	4-5W/M K
Terminations Available	Plated Nickel and Solder

IDC Low Inductance Capacitors (SnPb)

0306/0612/0508 IDC with Sn/Pb Termination

SIZE	0306		Thin 0508			0508			Thin 0612				0612					THICK 0612							
Max. Thickness	0.55 (0.022)		0.55 (0.022)			0.95 (0.037)			0.55 (0.022)				0.95 (0.037)					1.22 (0.048)							
WVDC	4	6.3	4	6.3	10	16	25	4	6.3	10	16	25	4	6.3	10	16	4	6.3	10	16	25	4	6.3	10	16
Cap (μF)	Grid content representing availability of capacitor values across different sizes and WVDC ratings																								
0.010	Grid content																								
0.022	Grid content																								
0.033	Grid content																								
0.047	Grid content																								
0.068	Grid content																								
0.10	Grid content																								
0.22	Grid content																								
0.33	Grid content																								
0.47	Grid content																								
0.68	Grid content																								
1.0	Grid content																								
1.5	Grid content																								
2.2	Grid content																								
3.3	Grid content																								

PHYSICAL DIMENSIONS AND PAD LAYOUT

Consult factory for additional requirements

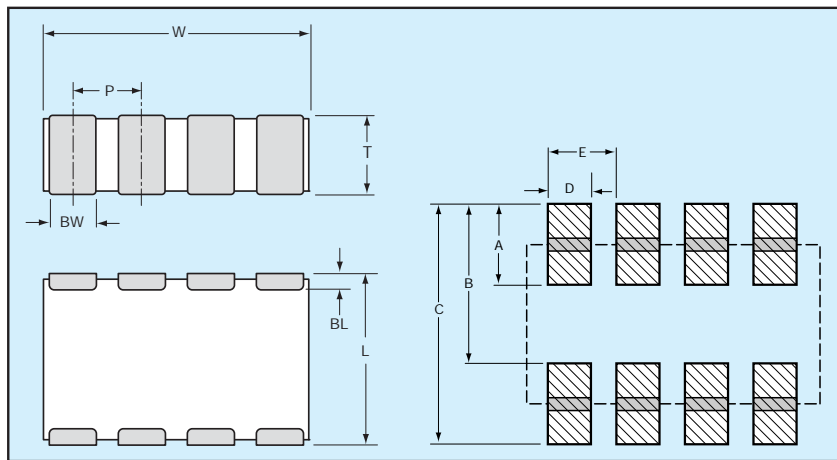

- = X7R
- = X5R
- = X7S

PHYSICAL CHIP DIMENSIONS millimeters (inches)

SIZE	W	L	BW	BL	P
0306	1.60 ± 0.20 (0.063 ± 0.008)	0.82 ± 0.10 (0.032 ± 0.006)	0.25 ± 0.10 (0.010 ± 0.004)	0.20 ± 0.10 (0.008 ± 0.004)	0.40 ± 0.05 (0.015 ± 0.002)
0508	2.03 ± 0.20 (0.080 ± 0.008)	1.27 ± 0.20 (0.050 ± 0.008)	0.30 ± 0.10 (0.012 ± 0.004)	0.25 ± 0.15 (0.010 ± 0.006)	0.50 ± 0.05 (0.020 ± 0.002)
0612	3.20 ± 0.20 (0.126 ± 0.008)	1.60 ± 0.20 (0.063 ± 0.008)	0.50 ± 0.10 (0.020 ± 0.004)	0.25 ± 0.15 (0.010 ± 0.006)	0.80 ± 0.10 (0.031 ± 0.004)

PAD LAYOUT DIMENSIONS

SIZE	A	B	C	D	E
0306	0.38 (0.015)	0.89 (0.035)	1.27 (0.050)	0.20 (0.008)	0.40 (0.015)
0508	0.64 (0.025)	1.27 (0.050)	1.91 (0.075)	0.28 (0.011)	0.50 (0.020)
0612	0.89 (0.035)	1.65 (0.065)	2.54 (0.100)	0.45 (0.018)	0.80 (0.031)

LGA Low Inductance Capacitors



0204/0306/0805 Land Grid Arrays

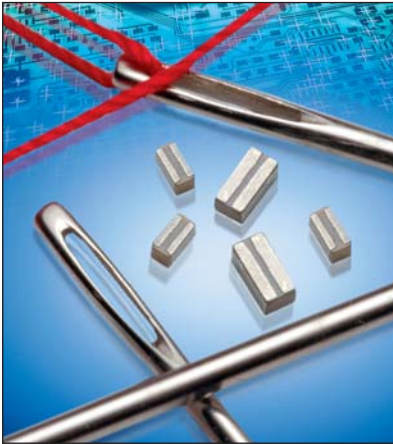

Land Grid Array (LGA) capacitors are the latest family of low inductance MLCCs from AVX. These new LGA products are the third low inductance family developed by AVX. The innovative LGA technology sets a new standard for low inductance MLCC performance. *Electronic Products* awarded its 2006 Product of the Year Award to the LGA Decoupling capacitor.

Our initial 2 terminal versions of LGA technology deliver the performance of an 8 terminal IDC low inductance MLCC with a number of advantages including:

- Simplified layout of 2 large solder pads compared to 8 small pads for IDCs
- Opportunity to reduce PCB or substrate contribution to system ESL by using multiple parallel vias in solder pads
- Advanced FCT manufacturing process used to create uniformly flat terminations on the capacitor that resist “tombstoning”
- Better solder joint reliability

APPLICATIONS

Semiconductor Packages

- Microprocessors/CPUs
- Graphics Processors/GPUs
- Chipsets
- FPGAs
- ASICs

Board Level Device Decoupling

- Frequencies of 300 MHz or more
- ICs drawing 15W or more
- Low voltages
- High speed buses



0306 2 TERMINAL LGA COMPARISON WITH 0306 8 TERMINAL IDC

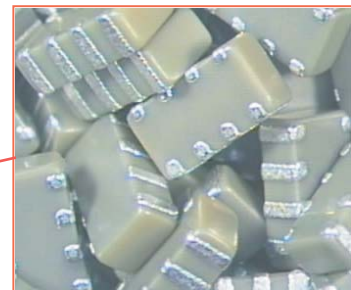
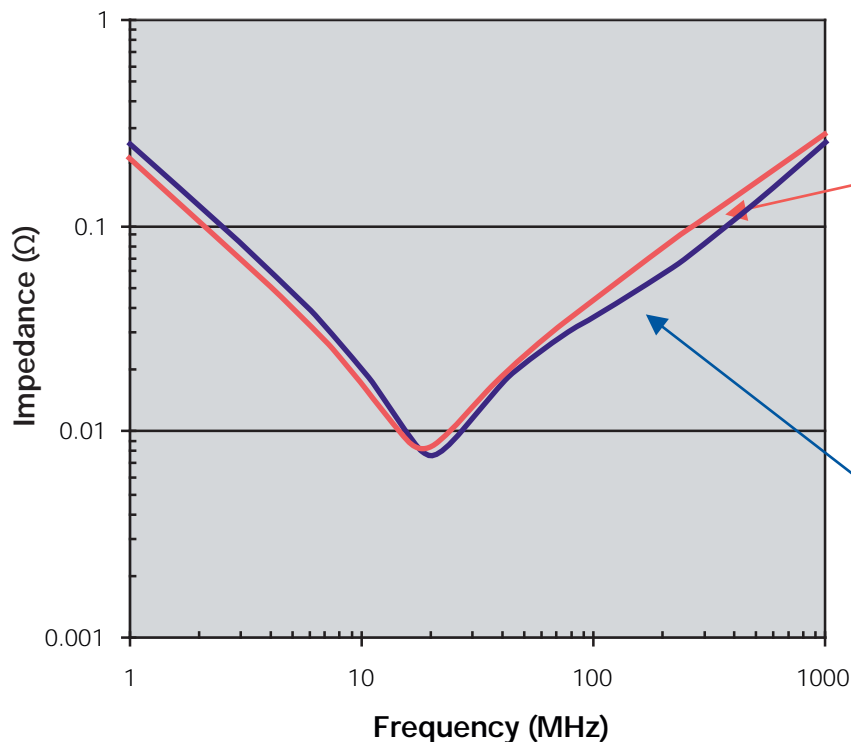

LGA Low Inductance Capacitors



0204/0306/0805 Land Grid Arrays

SIZE	LG12 (0204)						LG22 (0306)						LGC2 (0805)										
Length mm (in.)	0.50 (0.020)						0.76 (0.030)						2.06 (0.081)										
Width mm (in.)	1.00 (0.039)						1.60 (0.063)						1.32 (0.052)										
Temp. Char.	X5R (D)		X7S (Z)		X6S (W)		X7R (C)			X5R (D)		X7S (Z)		X6S (W)		X7R (C)		X5R (D)		X7S (Z)		X6S (W)	
Working Voltage	6.3 (6)	4 (4)	6.3 (6)	4 (4)	6.3 (6)	4 (4)	10 (Z)	6.3 (6)	4 (4)	6.3 (6)	4 (4)	6.3 (6)	4 (4)	6.3 (6)	4 (4)	6.3 (6)	4 (4)	6.3 (6)	4 (4)	6.3 (6)	4 (4)	6.3 (6)	4 (4)
Cap (µF)	0.010 (103)																						
	0.022 (223)																						
	0.047 (473)																						
	0.100 (104)																						
	0.220 (224)																						
	0.330 (334)																						
	0.470 (474)																						
	1.000 (105)																						
	2.200 (225)																						

= X7R
 = X5R
 = X7S
 = X6S

HOW TO ORDER

LG	1	2	6	Z	104	M	A	T	2	S	1
↓	↓	↓	↓	↓	↓	↓	↓	↓	↓	↓	↓
Style	Case Size	Number of Terminals	Working Voltage	Temperature Characteristic	Coded Cap	Cap Tolerance	Termination Style	Termination	Packaging Tape & Reel	Thickness	Number of Capacitors
	1 = 0204 2 = 0306 C = 0805	2	4 = 4V 6 = 6.3V Z = 10V	C = X7R D = X5R Z = X7S W = X6S		M = 20%	A = "U" Land	100% Sn* <small>*Contact factory for other termination finishes</small>	2 = 7" Reel 4 = 13" Reel	S = 0.55mm max	

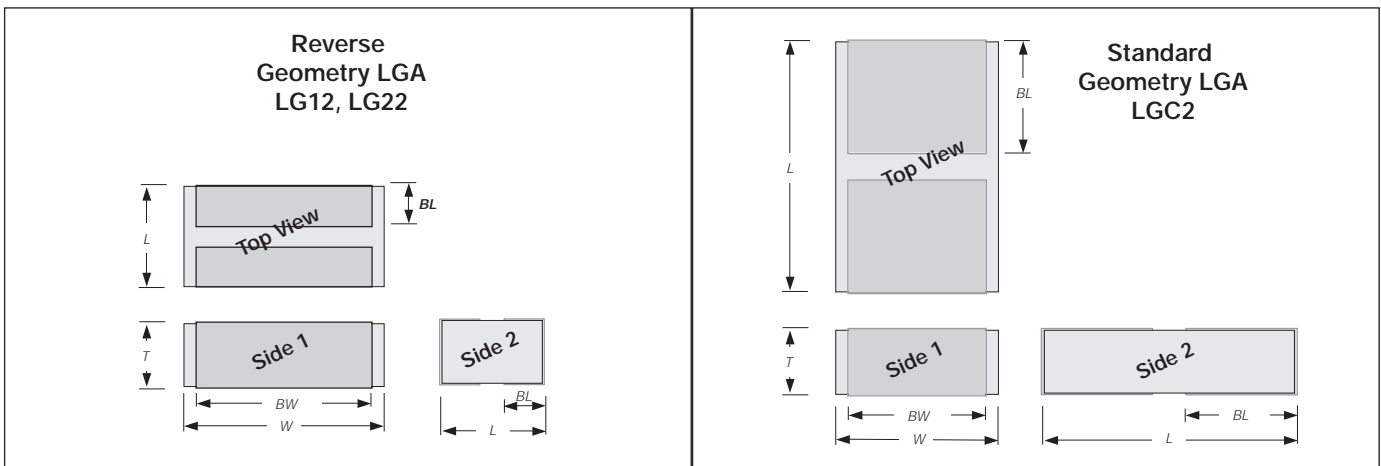

PART DIMENSIONS

Series	L	W	T	BW	BL
LG12 (0204)	0.5 ± 0.05 (0.020 ± 0.002)	1.00 ± 0.10 (0.039 ± 0.004)	0.50 ± 0.05 (0.020 ± 0.002)	0.8 ± 0.10 (0.031 ± 0.004)	0.13 ± 0.08 (0.005 ± 0.003)
LG22 (0306)	0.76 ± 0.10 (0.030 ± 0.004)	1.60 ± 0.10 (0.063 ± 0.004)	0.50 ± 0.05 (0.020 ± 0.002)	1.50 ± 0.10 (0.059 ± 0.004)	0.28 ± 0.08 (0.011 ± 0.003)
LGC2 (0805)	2.06 ± 0.10 (0.081 ± 0.004)	1.32 ± 0.10 (0.052 ± 0.004)	0.50 ± 0.05 (0.020 ± 0.002)	1.14 ± 0.10 (0.045 ± 0.004)	0.90 ± 0.08 (0.035 ± 0.003)

RECOMMENDED SOLDER PAD DIMENSIONS

Series	PL	PW1	G
LG12 (0204)	0.50 (0.020)	1.00 (0.039)	0.20 (0.008)
LG22 (0306)	0.65 (0.026)	1.50 (0.059)	0.20 (0.008)
LGC2 (0805)	1.25 (0.049)	1.40 (0.055)	0.20 (0.008)



LGA Low Inductance Capacitors



0204/0306/0805 Land Grid Arrays – Tin/Lead Termination “B”

SIZE	LG12 (0204)						LG22 (0306)						LGC2 (0805)										
Length mm (in.)	0.50 (0.020)						0.76 (0.030)						2.06 (0.081)										
Width mm (in.)	1.00 (0.039)						1.60 (0.063)						1.32 (0.052)										
Temp. Char.	X5R (D)		X7S (Z)		X6S (W)		X7R (C)			X5R (D)		X7S (Z)		X6S (W)		X7R (C)		X5R (D)		X7S (Z)		X6S (W)	
Working Voltage	6.3 (6)	4 (4)	6.3 (6)	4 (4)	6.3 (6)	4 (4)	10 (Z)	6.3 (6)	4 (4)	6.3 (6)	4 (4)	6.3 (6)	4 (4)	6.3 (6)	4 (4)	6.3 (6)	4 (4)	6.3 (6)	4 (4)	6.3 (6)	4 (4)	6.3 (6)	4 (4)
Cap (µF)	0.010 (103)																						
	0.022 (223)																						
	0.047 (473)																						
	0.100 (104)																						
	0.220 (224)																						
	0.330 (334)																						
	0.470 (474)																						
	1.000 (105)																						
	2.200 (225)																						

= X7R
 = X5R
 = X7S
 = X6S

HOW TO ORDER

PG	1	2	6	Z	104	M	A	B	2	S	1
Style	Case Size	Number of Terminals	Working Voltage	Temperature Characteristic	Coded Cap	Cap Tolerance	Termination Style	Termination	Packaging Tape & Reel	Thickness	Number of Capacitors
	1 = 0204 2 = 0306 C = 0805	2	4 = 4V 6 = 6.3V Z = 10V	C = X7R D = X5R Z = X7S W = X6S		M = 20%	A = "U" Land	5% Min Lead	2 = 7" Reel 4 = 13" Reel	S = 0.55mm max	

Not RoHS Compliant

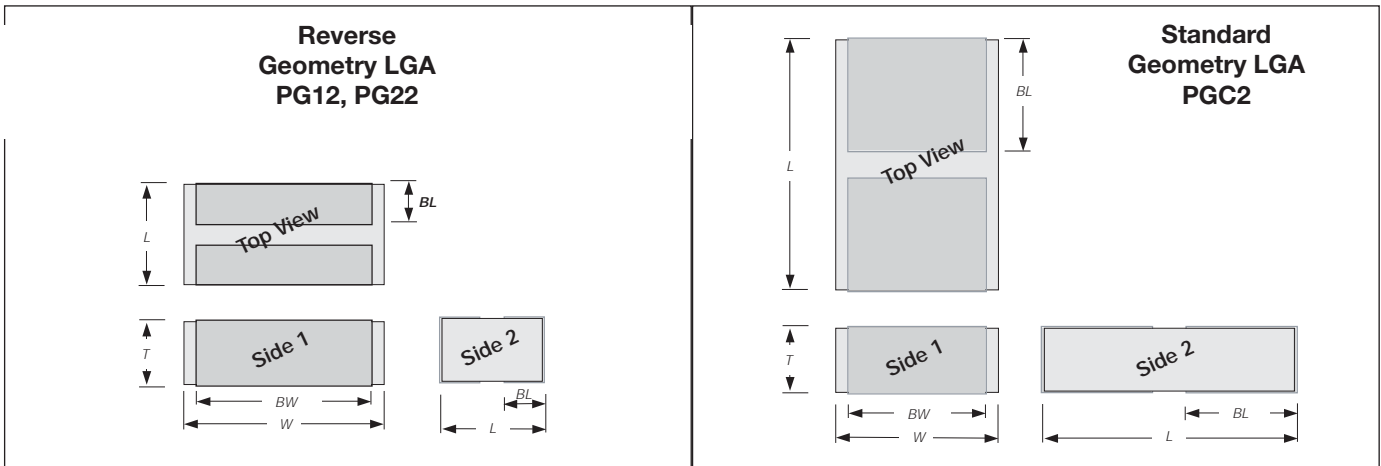

PART DIMENSIONS

Series	L	W	T	BW	BL
PG12 (0204)	0.5 ± 0.05 (0.020 ± 0.002)	1.00 ± 0.10 (0.039 ± 0.004)	0.50 ± 0.05 (0.020 ± 0.002)	0.8 ± 0.10 (0.031 ± 0.004)	0.13 ± 0.08 (0.005 ± 0.003)
PG22 (0306)	0.76 ± 0.10 (0.030 ± 0.004)	1.60 ± 0.10 (0.063 ± 0.004)	0.50 ± 0.05 (0.020 ± 0.002)	1.50 ± 0.10 (0.059 ± 0.004)	0.28 ± 0.08 (0.011 ± 0.003)
PGC2 (0805)	2.06 ± 0.10 (0.081 ± 0.004)	1.32 ± 0.10 (0.052 ± 0.004)	0.50 ± 0.05 (0.020 ± 0.002)	1.14 ± 0.10 (0.045 ± 0.004)	0.90 ± 0.08 (0.035 ± 0.003)

RECOMMENDED SOLDER PAD DIMENSIONS

mm (inches)

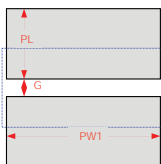

Series	PL	PW1	G
PG12 (0204)	0.50 (0.020)	1.00 (0.039)	0.20 (0.008)
PG22 (0306)	0.65 (0.026)	1.50 (0.059)	0.20 (0.008)
PGC2 (0805)	1.25 (0.049)	1.40 (0.055)	0.20 (0.008)



Low Inductance Capacitors



LICA® (Low Inductance Decoupling Capacitor Arrays)



LICA® arrays utilize up to four separate capacitor sections in one ceramic body (see Configurations and Capacitance Options). These designs exhibit a number of technical advancements:

Low Inductance features–

- Low resistance platinum electrodes in a low aspect ratio pattern
- Double electrode pickup and perpendicular current paths
- C4 “flip-chip” technology for minimal interconnect inductance

HOW TO ORDER

LICA	3	T	102	M	3	F	C	4	A	A
Style & Size	5V = 9 10V = Z 25V = 3	Dielectric D = X5R T = T55T S = High K T55T	Cap/Section (EIA Code) 102 = 1000 pF 103 = 10 nF 104 = 100 nF	Capacitance Tolerance M = ±20% P = GMV	Height Code 6 = 0.500mm 3 = 0.650mm 1 = 0.875mm 5 = 1.100mm 7 = 1.600mm	Termination F = C4 Solder Balls- 97Pb/3Sn H = C4 Solder Balls Low ESR G = Lead Free SAC R = Cr-Cu-Au N = Cr-Ni-Au V = Eutectic Lead-Tin Bump- 37%Pb/63%Sn X = None	Reel Packaging M = 7" Reel R = 13" Reel 6 = 2"x2" Waffle Pack 8 = 2"x2" Black Waffle Pack 7 = 2"x2" Waffle Pack w/ termination facing up A = 2"x2" Black Waffle Pack w/ termination facing up C = 4"x4" Waffle Pack w/ clear lid	# of Caps/Part 1 = one 2 = two 4 = four	Inspection Code A = Standard B = COTS+ X = MIL-PRF-123	Code Face A = Bar B = No Bar C = Dot, S55S Dielectrics D = Triangle

NOTE: Contact factory for availability of Termination and Tolerance Options for Specific Part Numbers.

TABLE 1

Typical Parameters	T55T/S55S	Units
Capacitance, 25°C	Co	Nanofarads
Capacitance, 55°C	1.45 x Co	Nanofarads
Capacitance, 85°C	0.7 x Co	Nanofarads
Dissipation Factor 25°	15	Percent
ESR (Nominal)	20	Milliohms
DC Resistance	0.2	Ohms
IR (Minimum @25°) (Design Dependent)	300	Megaohms
Dielectric Breakdown, Min	500	Volts
Thermal Coefficient of Expansion	8.5	ppm/°C 25-100°
Inductance: (Design Dependent) (Nominal)	30	Pico-Henries
Frequency of Operation	DC to 5 Gigahertz	
Ambient Temp Range	-55° to 125°C	



SOLDER BALL AND PAD DIMENSIONS

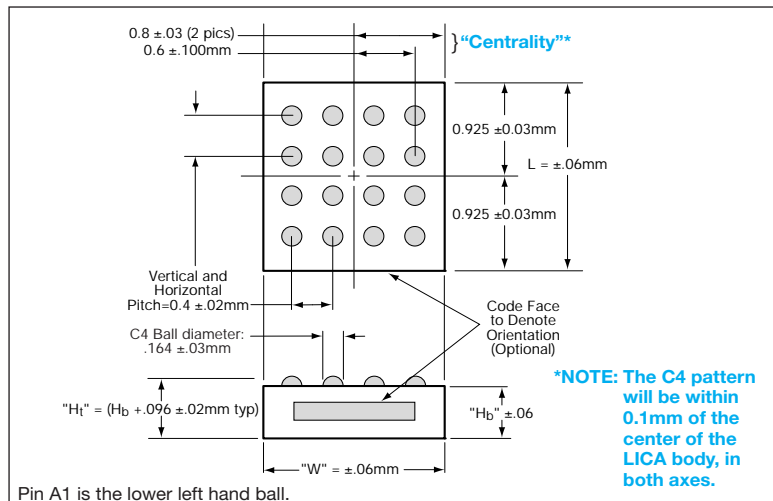

Code (Body Height)	Width (W)	Length (L)	Height Body (Hb)
1	1.600mm	1.850mm	0.875mm
3	1.600mm	1.850mm	0.650mm
5	1.600mm	1.850mm	1.100mm
6	1.600mm	1.850mm	0.500mm
7	1.600mm	1.850mm	1.600mm

TERMINATION OPTIONS

SOLDER BALLS
TERMINATION OPTION F, H, G OR V

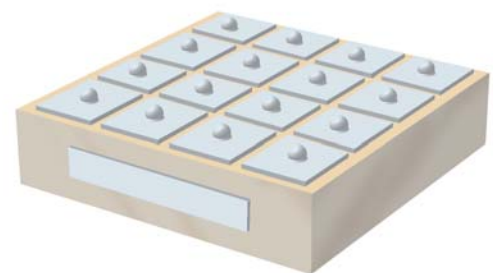

TERMINATION OPTION R OR N

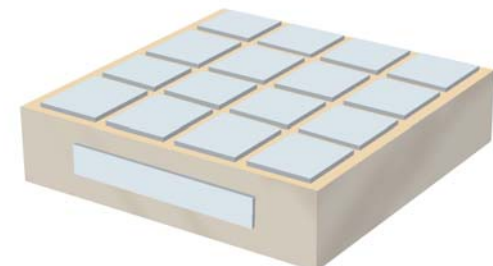

Low Inductance Capacitors



LICA® (Low Inductance Decoupling Capacitor Arrays)

TEMPERATURE VS CAPACITANCE CHANGE

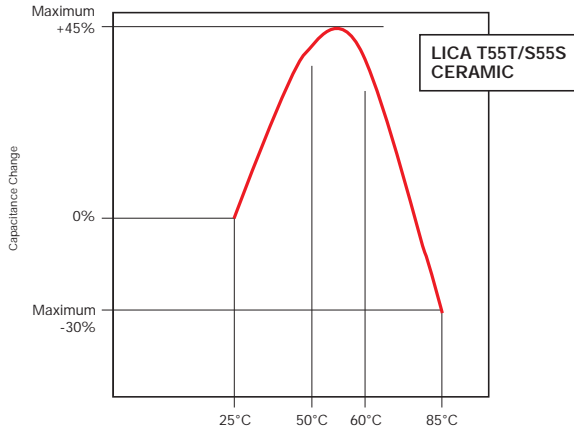

TYPICAL S21 FOR LICA AT SINGLE VIA

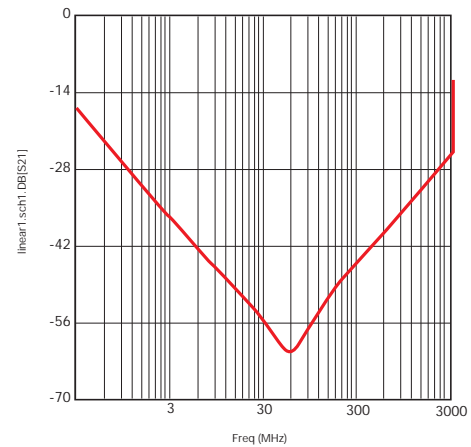

LICA COMMON PART NUMBER LIST

Part Number	Voltage	Thickness (mm)	Capacitors per Package
LICA3T193M3FC4AA	25	0.650	4
LICA3T153P3FC4AA	25	0.650	4
LICA3T134M1FC1AA	25	0.875	1
LICA3T104P1FC1AA	25	0.875	1
LICA3T333M1FC4AA	25	0.875	4
LICA3T263P3FC4AA	25	0.650	4
LICA3T244M5FC1AA	25	1.100	1
LICA3T194P5FC1AA	25	1.100	1
LICA3T394M7FC1AB	25	1.600	1
LICA3T314P7FC1AB	25	1.600	1
Extended Range			
LICAZT623M3FC4AB	10	0.650	4
LICA3T104M3FC1A	25	0.650	1
LICA3T803P3FC1A	25	0.650	1
LICA3T423M3FC2A	25	0.650	2
LICA3T333P3FC2A	25	0.650	2
LICA3S253M3FC4A	25	0.650	4
LICAZD753M3FC4AD	10	0.650	4
LICAZD504M3FC1AB	10	0.650	1
LICAZD604M7FC1AB	10	1.600	1
LICA3D193M3FC4AB	25	0.650	4

CONFIGURATION

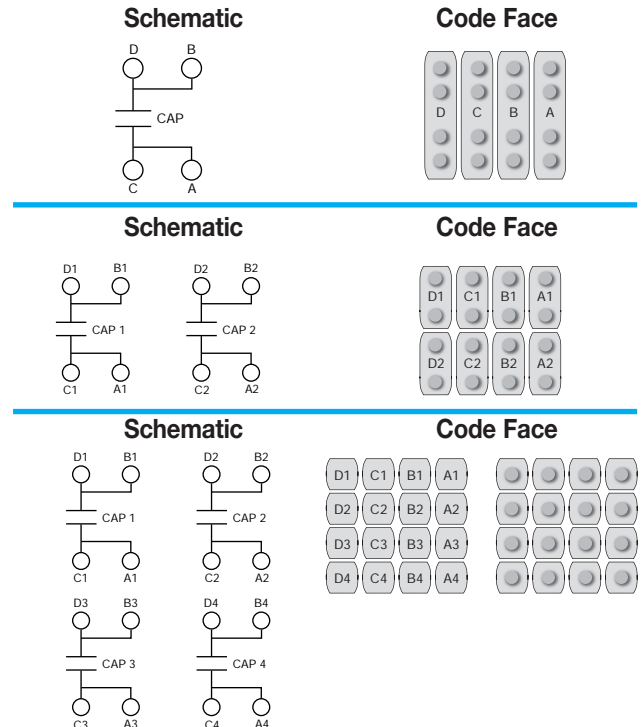

WAFFLE PACK OPTIONS FOR LICA®

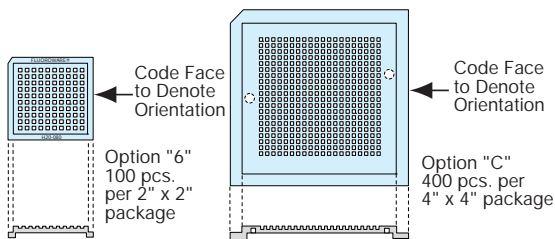

Note: Standard configuration is Termination side down

LICA® PACKAGING SCHEME "M" AND "R"

8mm conductive plastic tape on reel:
 "M"=7" reel max. qty. 3,000, "R"=13" reel max. qty. 8,000

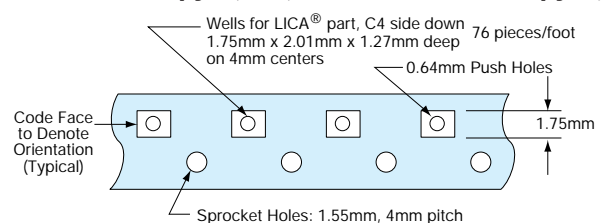

High Voltage MLC Chips



For 600V to 5000V Applications

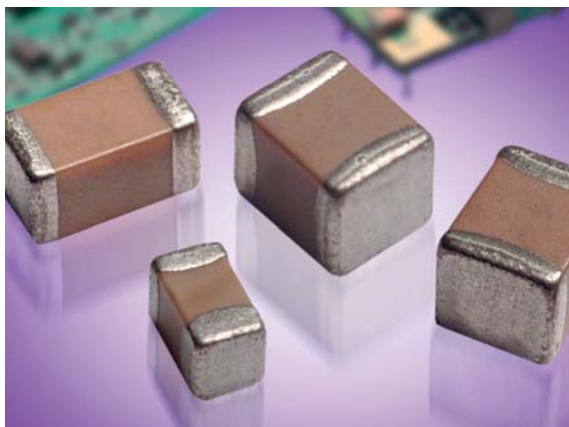

NEW 630V RANGE

High value, low leakage and small size are difficult parameters to obtain in capacitors for high voltage systems. AVX special high voltage MLC chip capacitors meet these performance characteristics and are designed for applications such as snubbers in high frequency power converters, resonators in SMPS, and high voltage coupling/dc blocking. These high voltage chip designs exhibit low ESRs at high frequencies.

Larger physical sizes than normally encountered chips are used to make high voltage MLC chip products. Special precautions must be taken in applying these chips in surface mount assemblies. The temperature gradient during heating or cooling cycles should not exceed 4°C per second. The preheat temperature must be within 50°C of the peak temperature reached by the ceramic bodies through the soldering process. Chip sizes 1210 and larger should be reflow soldered only. Capacitors may require protective surface coating to prevent external arcing.

For 1825, 2225 and 3640 sizes, AVX offers leaded version in either thru-hole or SMT configurations (for details see section on high voltage leaded MLC chips).

HOW TO ORDER

1808	A	A	271	K	A	1	1	A
AVX Style	Voltage	Temperature Coefficient	Capacitance Code (2 significant digits + no. of zeros) Examples:	Capacitance Tolerance COG: J = ±5% K = ±10% M = ±20% X7R: K = ±10% M = ±20% Z = +80%, -20%	Test Level A = Standard	Termination* 1 = Pd/Ag T = Plated Ni and Sn (RoHS Compliant)	Packaging 1 = 7" Reel 3 = 13" Reel 9 = Bulk	Special Code A = Standard
0805	600V/630V = C	COG = A	10 pF = 100					
1206	1000V = A	X7R = C	100 pF = 101					
1210	1500V = S		1,000 pF = 102					
1808	2000V = G		22,000 pF = 223					
1812	2500V = W		220,000 pF = 224					
1825	3000V = H		1 μF = 105					
2220	4000V = J							
2225	5000V = K							
3640								

***Note:** Terminations with 5% minimum lead (Pb) is available, see pages 83 and 84 for LD style. Leaded terminations are available, see pages 85 and 86.

Notes: Capacitors with X7R dielectrics are not intended for applications across AC supply mains or AC line filtering with polarity reversal. Contact plant for recommendations. Contact factory for availability of Termination and Tolerance options for Specific Part Numbers.

*** AVX offers nonstandard chip sizes. Contact factory for details.

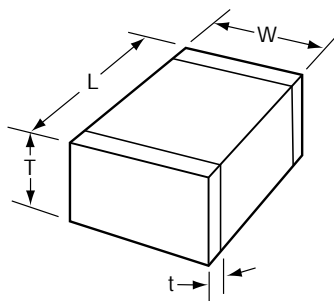

DIMENSIONS

millimeters (inches)

SIZE	0805	1206	1210*	1808*	1812*	1825*	2220*	2225*	3640*
(L) Length	2.01 ± 0.20 (0.079 ± 0.008)	3.20 ± 0.20 (0.126 ± 0.008)	3.20 ± 0.20 (0.126 ± 0.008)	4.57 ± 0.25 (0.180 ± 0.010)	4.50 ± 0.30 (0.177 ± 0.012)	4.50 ± 0.30 (0.177 ± 0.012)	5.70 ± 0.40 (0.224 ± 0.016)	5.72 ± 0.25 (0.225 ± 0.010)	9.14 ± 0.25 (0.360 ± 0.010)
(W) Width	1.25 ± 0.20 (0.049 ± 0.008)	1.60 ± 0.20 (0.063 ± 0.008)	2.50 ± 0.20 (0.098 ± 0.008)	2.03 ± 0.25 (0.080 ± 0.010)	3.20 ± 0.20 (0.126 ± 0.008)	6.40 ± 0.30 (0.252 ± 0.012)	5.00 ± 0.40 (0.197 ± 0.016)	6.35 ± 0.25 (0.250 ± 0.010)	10.2 ± 0.25 (0.400 ± 0.010)
(T) Thickness Max.	1.30 (0.051)	1.52 (0.060)	1.70 (0.067)	2.03 (0.080)	2.54 (0.100)	2.54 (0.100)	3.30 (0.130)	2.54 (0.100)	2.54 (0.100)
(t) terminal min. max.	0.50 ± 0.25 (0.020 ± 0.010)	0.25 (0.010) 0.75 (0.030)	0.25 (0.010) 0.75 (0.030)	0.25 (0.010) 1.02 (0.040)	0.25 (0.010) 1.02 (0.040)	0.25 (0.010) 1.02 (0.040)	0.25 (0.010) 1.02 (0.040)	0.25 (0.010) 1.02 (0.040)	0.76 (0.030) 1.52 (0.060)

*Reflow Soldering Only



High Voltage MLC Chips



For 600V to 5000V Applications

C0G Dielectric

Performance Characteristics

Capacitance Range	10 pF to 0.047 μ F (25°C, 1.0 \pm 0.2 Vrms at 1kHz, for \leq 1000 pF use 1 MHz)
Capacitance Tolerances	\pm 5%, \pm 10%, \pm 20%
Dissipation Factor	0.1% max. (+25°C, 1.0 \pm 0.2 Vrms, 1kHz, for \leq 1000 pF use 1 MHz)
Operating Temperature Range	-55°C to +125°C
Temperature Characteristic	0 \pm 30 ppm/°C (0 VDC)
Voltage Ratings	600, 630, 1000, 1500, 2000, 2500, 3000, 4000 & 5000 VDC (+125°C)
Insulation Resistance (+25°C, at 500 VDC)	100K M Ω min. or 1000 M Ω - μ F min., whichever is less
Insulation Resistance (+125°C, at 500 VDC)	10K M Ω min. or 100 M Ω - μ F min., whichever is less
Dielectric Strength	Minimum 120% rated voltage for 5 seconds at 50 mA max. current

HIGH VOLTAGE C0G CAPACITANCE VALUES

VOLTAGE	0805	1206	1210	1808	1812	1825	2220	2225	3640	
600/630	min.	10pF	10 pF	100 pF	100 pF	100 pF	1000 pF	1000 pF	1000 pF	1000 pF
	max.	330pF	1200 pF	2700 pF	3300 pF	5600 pF	0.012 μ F	0.012 μ F	0.018 μ F	0.047 μ F
1000	min.	10pF	10 pF	10 pF	100 pF	100 pF	100 pF	1000 pF	1000 pF	1000 pF
	max.	180pF	560 pF	1500 pF	2200 pF	3300 pF	8200 pF	0.010 μ F	0.010 μ F	0.022 μ F
1500	min.	—	10 pF	10 pF	10 pF	10 pF	100 pF	100 pF	100 pF	100 pF
	max.	—	270 pF	680 pF	820 pF	1800 pF	4700 pF	4700 pF	5600 pF	0.010 μ F
2000	min.	—	10 pF	10 pF	10 pF	10 pF	100 pF	100 pF	100 pF	100 pF
	max.	—	120 pF	270 pF	330 pF	1000 pF	1800 pF	2200 pF	2700 pF	6800 pF
2500	min.	—	—	—	10 pF	10 pF	10 pF	100 pF	100 pF	100 pF
	max.	—	—	—	180 pF	470 pF	1200 pF	1500 pF	1800 pF	3900 pF
3000	min.	—	—	—	10 pF	10 pF	10 pF	10 pF	10 pF	100 pF
	max.	—	—	—	120 pF	330 pF	820 pF	1000 pF	1200 pF	2700 pF
4000	min.	—	—	—	10 pF	10 pF	10 pF	10 pF	10 pF	100 pF
	max.	—	—	—	47 pF	150 pF	330 pF	470 pF	560 pF	1200 pF
5000	min.	—	—	—	—	—	—	10 pF	10 pF	10 pF
	max.	—	—	—	—	—	—	220 pF	270 pF	820 pF

X7R Dielectric

Performance Characteristics

Capacitance Range	10 pF to 0.56 μ F (25°C, 1.0 \pm 0.2 Vrms at 1kHz)
Capacitance Tolerances	\pm 10%; \pm 20%; +80%, -20%
Dissipation Factor	2.5% max. (+25°C, 1.0 \pm 0.2 Vrms, 1kHz)
Operating Temperature Range	-55°C to +125°C
Temperature Characteristic	\pm 15% (0 VDC)
Voltage Ratings	600, 630, 1000, 1500, 2000, 2500, 3000, 4000 & 5000 VDC (+125°C)
Insulation Resistance (+25°C, at 500 VDC)	100K M Ω min. or 1000 M Ω - μ F min., whichever is less
Insulation Resistance (+125°C, at 500 VDC)	10K M Ω min. or 100 M Ω - μ F min., whichever is less
Dielectric Strength	Minimum 120% rated voltage for 5 seconds at 50 mA max. current

HIGH VOLTAGE X7R MAXIMUM CAPACITANCE VALUES

VOLTAGE	0805	1206	1210	1808	1812	1825	2220	2225	3640	
600/630	min.	100pF	1000 pF	1000 pF	1000 pF	1000 pF	0.010 μ F	0.010 μ F	0.010 μ F	0.010 μ F
	max.	6800pF	0.022 μ F	0.056 μ F	0.068 μ F	0.120 μ F	0.270 μ F	0.270 μ F	0.330 μ F	0.560 μ F
1000	min.	100pF	100 pF	1000 pF	1000 pF	1000 pF	1000 pF	1000 pF	1000 pF	1000 pF
	max.	1500pF	6800 pF	0.015 μ F	0.018 μ F	0.039 μ F	0.100 μ F	0.120 μ F	0.150 μ F	0.220 μ F
1500	min.	—	100 pF	100 pF	100 pF	100 pF	1000 pF	1000 pF	1000 pF	1000 pF
	max.	—	2700 pF	5600 pF	6800 pF	0.015 μ F	0.056 μ F	0.056 μ F	0.068 μ F	0.100 μ F
2000	min.	—	10 pF	100 pF	100 pF	100 pF	100 pF	1000 pF	1000 pF	1000 pF
	max.	—	1500 pF	3300 pF	3300 pF	8200 pF	0.022 μ F	0.027 μ F	0.033 μ F	0.027 μ F
2500	min.	—	—	—	10 pF	10 pF	100 pF	100 pF	100 pF	1000 pF
	max.	—	—	—	2200 pF	5600 pF	0.015 μ F	0.018 μ F	0.022 μ F	0.022 μ F
3000	min.	—	—	—	10 pF	10 pF	100 pF	100 pF	100 pF	1000 pF
	max.	—	—	—	1800 pF	3900 pF	0.010 μ F	0.012 μ F	0.015 μ F	0.018 μ F
4000	min.	—	—	—	—	—	—	—	—	100 pF
	max.	—	—	—	—	—	—	—	—	6800 pF
5000	min.	—	—	—	—	—	—	—	—	100 pF
	max.	—	—	—	—	—	—	—	—	3300 pF



High Voltage MLC Chips Tin/Lead Termination “B”

For 600V to 5000V Applications

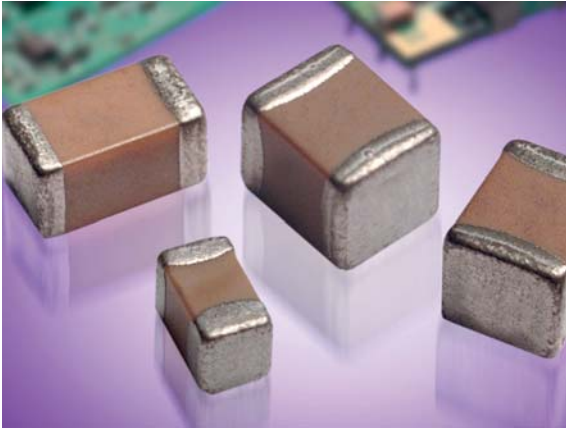

NEW 630V RANGE

AVX Corporation will support those customers for commercial and military Multilayer Ceramic Capacitors with a termination consisting of 5% minimum lead. This termination is indicated by the use of a “B” in the 12th position of the AVX Catalog Part Number. This fulfills AVX’s commitment to providing a full range of products to our customers. AVX has provided in the following pages, a full range of values that we are offering in this “B” termination.

Larger physical sizes than normally encountered chips are used to make high voltage MLC chip product. Special precautions must be taken in applying these chips in surface mount assemblies. The temperature gradient during heating or cooling cycles should not exceed 4°C per second. The preheat temperature must be within 50°C of the peak temperature reached by the ceramic bodies through the soldering process. Chip sizes 1210 and larger should be reflow soldered only. Capacitors may require protective surface coating to prevent external arcing.

For 1825, 2225 and 3640 sizes, AVX offers leaded version in either thru-hole or SMT configurations (for details see section on high voltage leaded MLC chips).

Not RoHS Compliant

HOW TO ORDER

LD08	A	A	271	K	A	B	1	A
AVX Style	Voltage	Temperature Coefficient	Capacitance Code (2 significant digits + no. of zeros) Examples: 10 pF = 100 100 pF = 101 1,000 pF = 102 22,000 pF = 223 220,000 pF = 224 1 μF = 105	Capacitance Tolerance COG: J = ±5% K = ±10% M = ±20% X7R: K = ±10% M = ±20% Z = +80%, -20%	Test Level A = Standard	Termination B = 5% Min Pb	Packaging 1 = 7" Reel 3 = 13" Reel 9 = Bulk	Special Code A = Standard
LD05 - 0805	600V/630V = C 1000V = A	COG = A X7R = C						
LD06 - 1206	1500V = S							
LD10 - 1210	2000V = G							
LD08 - 1808	2500V = W							
LD12 - 1812	3000V = H							
LD13 - 1825	4000V = J							
LD20 - 2220	5000V = K							
LD14 - 2225								
LD40 - 3640								

Notes: Capacitors with X7R dielectrics are not intended for applications across AC supply mains or AC line filtering with polarity reversal. Contact plant for recommendations. Contact factory for availability of Termination and Tolerance options for Specific Part Numbers.

*** AVX offers nonstandard chip sizes. Contact factory for details.

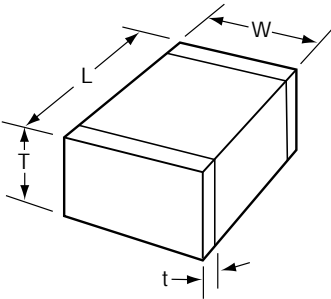

DIMENSIONS

SIZE	LD05 (0805)	LD06 (1206)	LD10* (1210)	LD08* (1808)	LD12* (1812)	LD13* (1825)	LD20* (2220)	LD14* (2225)	LD40* (3640)
(L) Length	2.01 ± 0.20 (0.079 ± 0.008)	3.20 ± 0.20 (0.126 ± 0.008)	3.20 ± 0.20 (0.126 ± 0.008)	4.57 ± 0.25 (0.180 ± 0.010)	4.50 ± 0.30 (0.177 ± 0.012)	4.50 ± 0.30 (0.177 ± 0.012)	5.70 ± 0.40 (0.224 ± 0.016)	5.72 ± 0.25 (0.225 ± 0.010)	9.14 ± 0.25 (0.360 ± 0.010)
(W) Width	1.25 ± 0.20 (0.049 ± 0.008)	1.60 ± 0.20 (0.063 ± 0.008)	2.50 ± 0.20 (0.098 ± 0.008)	2.03 ± 0.25 (0.080 ± 0.010)	3.20 ± 0.20 (0.126 ± 0.008)	6.40 ± 0.30 (0.252 ± 0.012)	5.00 ± 0.40 (0.197 ± 0.016)	6.35 ± 0.25 (0.250 ± 0.010)	10.2 ± 0.25 (0.400 ± 0.010)
(T) Thickness Max.	1.30 (0.051)	1.52 (0.060)	1.70 (0.067)	2.03 (0.080)	2.54 (0.100)	2.54 (0.100)	3.30 (0.130)	2.54 (0.100)	2.54 (0.100)
(t) terminal min. max.	0.50 ± 0.25 (0.020 ± 0.010)	0.25 (0.010) 0.75 (0.030)	0.25 (0.010) 0.75 (0.030)	0.25 (0.010) 1.02 (0.040)	0.25 (0.010) 1.02 (0.040)	0.25 (0.010) 1.02 (0.040)	0.25 (0.010) 1.02 (0.040)	0.25 (0.010) 1.02 (0.040)	0.76 (0.030) 1.52 (0.060)

* Reflow soldering only.



High Voltage MLC Chips Tin/Lead Termination “B”



For 600V to 5000V Applications

C0G Dielectric Performance Characteristics

Capacitance Range	10 pF to 0.047 μ F (25°C, 1.0 \pm 0.2 Vrms at 1kHz, for \leq 1000 pF use 1 MHz)
Capacitance Tolerances	\pm 5%, \pm 10%, \pm 20%
Dissipation Factor	0.1% max. (+25°C, 1.0 \pm 0.2 Vrms, 1kHz, for \leq 1000 pF use 1 MHz)
Operating Temperature Range	-55°C to +125°C
Temperature Characteristic	0 \pm 30 ppm/°C (0 VDC)
Voltage Ratings	600, 630, 1000, 1500, 2000, 2500, 3000, 4000 & 5000 VDC (+125°C)
Insulation Resistance (+25°C, at 500 VDC)	100K M Ω min. or 1000 M Ω - μ F min., whichever is less
Insulation Resistance (+125°C, at 500 VDC)	10K M Ω min. or 100 M Ω - μ F min., whichever is less
Dielectric Strength	Minimum 120% rated voltage for 5 seconds at 50 mA max. current

HIGH VOLTAGE C0G CAPACITANCE VALUES

VOLTAGE	LD05 (0805)	LD06 (1206)	LD10 (1210)	LD08 (1808)	LD12 (1812)	LD13 (1825)	LD20 (2220)	LD14 (2225)	LD40 (3640)
600/630 min.	10pF	10 pF	100 pF	100 pF	100 pF	1000 pF	1000 pF	1000 pF	1000 pF
600/630 max.	330pF	1200 pF	2700 pF	3300 pF	5600 pF	0.012 μ F	0.012 μ F	0.018 μ F	0.047 μ F
1000 min.	10pF	10 pF	10 pF	100 pF	100 pF	100 pF	1000 pF	1000 pF	1000 pF
1000 max.	180pF	560 pF	1500 pF	2200 pF	3300 pF	8200 pF	0.010 μ F	0.010 μ F	0.022 μ F
1500 min.	—	10 pF	10 pF	10 pF	10 pF	100 pF	100 pF	100 pF	100 pF
1500 max.	—	270 pF	680 pF	820 pF	1800 pF	4700 pF	4700 pF	5600 pF	0.010 μ F
2000 min.	—	10 pF	10 pF	10 pF	10 pF	100 pF	100 pF	100 pF	100 pF
2000 max.	—	120 pF	270 pF	330 pF	1000 pF	1800 pF	2200 pF	2700 pF	6800 pF
2500 min.	—	—	—	10 pF	10 pF	10 pF	100 pF	100 pF	100 pF
2500 max.	—	—	—	180 pF	470 pF	1200 pF	1500 pF	1800 pF	3900 pF
3000 min.	—	—	—	10 pF	10 pF	10 pF	10 pF	10 pF	100 pF
3000 max.	—	—	—	120 pF	330 pF	820 pF	1000 pF	1200 pF	2700 pF
4000 min.	—	—	—	10 pF	10 pF	10 pF	10 pF	10 pF	100 pF
4000 max.	—	—	—	47 pF	150 pF	330 pF	470 pF	560 pF	1200 pF
5000 min.	—	—	—	—	—	—	10 pF	10 pF	10 pF
5000 max.	—	—	—	—	—	—	220 pF	270 pF	820 pF

X7R Dielectric Performance Characteristics

Capacitance Range	10 pF to 0.56 μ F (25°C, 1.0 \pm 0.2 Vrms at 1kHz)
Capacitance Tolerances	\pm 10%; \pm 20%; +80%, -20%
Dissipation Factor	2.5% max. (+25°C, 1.0 \pm 0.2 Vrms, 1kHz)
Operating Temperature Range	-55°C to +125°C
Temperature Characteristic	\pm 15% (0 VDC)
Voltage Ratings	600, 630, 1000, 1500, 2000, 2500, 3000, 4000 & 5000 VDC (+125°C)
Insulation Resistance (+25°C, at 500 VDC)	100K M Ω min. or 1000 M Ω - μ F min., whichever is less
Insulation Resistance (+125°C, at 500 VDC)	10K M Ω min. or 100 M Ω - μ F min., whichever is less
Dielectric Strength	Minimum 120% rated voltage for 5 seconds at 50 mA max. current

HIGH VOLTAGE X7R MAXIMUM CAPACITANCE VALUES

VOLTAGE	0805	1206	1210	1808	1812	1825	2220	2225	3640
600/630 min.	100pF	1000 pF	1000 pF	1000 pF	1000 pF	0.010 μ F	0.010 μ F	0.010 μ F	0.010 μ F
600/630 max.	6800pF	0.022 μ F	0.056 μ F	0.068 μ F	0.120 μ F	0.270 μ F	0.270 μ F	0.330 μ F	0.560 μ F
1000 min.	100pF	100 pF	1000 pF	1000 pF	1000 pF	1000 pF	1000 pF	1000 pF	0.010 μ F
1000 max.	1500pF	6800 pF	0.015 μ F	0.018 μ F	0.039 μ F	0.100 μ F	0.120 μ F	0.150 μ F	0.220 μ F
1500 min.	—	100 pF	100 pF	100 pF	100 pF	1000 pF	1000 pF	1000 pF	1000 pF
1500 max.	—	2700 pF	5600 pF	6800 pF	0.015 μ F	0.056 μ F	0.056 μ F	0.068 μ F	0.100 μ F
2000 min.	—	10 pF	100 pF	100 pF	100 pF	100 pF	1000 pF	1000 pF	1000 pF
2000 max.	—	1500 pF	3300 pF	3300 pF	8200 pF	0.022 μ F	0.027 μ F	0.033 μ F	0.027 μ F
2500 min.	—	—	—	10 pF	10 pF	100 pF	100 pF	100 pF	1000 pF
2500 max.	—	—	—	2200 pF	5600 pF	0.015 μ F	0.018 μ F	0.022 μ F	0.022 μ F
3000 min.	—	—	—	10 pF	10 pF	100 pF	100 pF	100 pF	1000 pF
3000 max.	—	—	—	1800 pF	3900 pF	0.010 μ F	0.012 μ F	0.015 μ F	0.018 μ F
4000 min.	—	—	—	—	—	—	—	—	100 pF
4000 max.	—	—	—	—	—	—	—	—	6800 pF
5000 min.	—	—	—	—	—	—	—	—	100 pF
5000 max.	—	—	—	—	—	—	—	—	3300 pF

High Voltage MLC Chips FLEXITERM®



For 600V to 3000V Applications

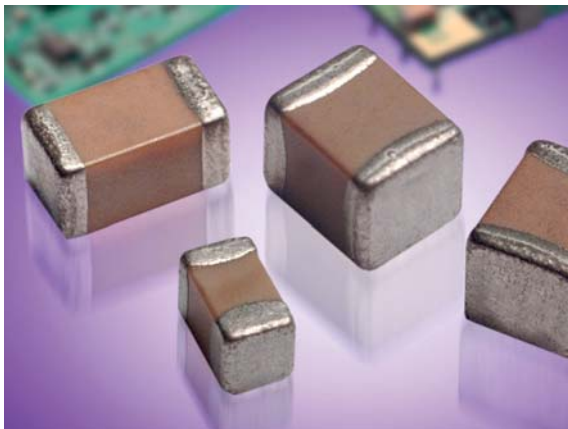

High value, low leakage and small size are difficult parameters to obtain in capacitors for high voltage systems. AVX special high voltage MLC chips capacitors meet these performance characteristics and are designed for applications such as snubbers in high frequency power converters, resonators in SMPS, and high voltage coupling/DC blocking. These high voltage chip designs exhibit low ESRs at high frequencies.

To make high voltage chips, larger physical sizes than are normally encountered are necessary. These larger sizes require that special precautions be taken in applying these chips in surface mount assemblies. In response to this, and to follow from the success of the FLEXITERM® range of low voltage parts, AVX is delighted to offer a FLEXITERM® high voltage range of capacitors, FLEXITERM®.

The FLEXITERM® layer is designed to enhance the mechanical flexure and temperature cycling performance of a standard ceramic capacitor, giving customers a solution where board flexure or temperature cycle damage are concerns.



HOW TO ORDER

1808	A	C	272	K	A	Z	1	A
AVX Style	Voltage	Temperature Coefficient	Capacitance Code (2 significant digits + no. of zeros) Examples:	Capacitance Tolerance COG: J = ±5% K = ±10% M = ±20% X7R: K = ±10% M = ±20% Z = +80%, -20%	Test Level	Termination* Z = FLEXITERM® 100% Tin (RoHS Compliant)	Packaging 1 = 7" Reel 3 = 13" Reel 9 = Bulk	Special Code A = Standard
0805	600V/630V = C 1000V = A 1500V = S 2000V = G 2500V = W 3000V = H	COG = A X7R = C	10 pF = 100 100 pF = 101 1,000 pF = 102 22,000 pF = 223 220,000 pF = 224 1 μF = 105					
1206								
1210								
1808								
1812								
1825								
2220								
2225								

Notes: Capacitors with X7R dielectrics are not intended for applications across AC supply mains or AC line filtering with polarity reversal. Contact plant for recommendations. Contact factory for availability of Termination and Tolerance options for Specific Part Numbers.

*** AVX offers nonstandard chip sizes. Contact factory for details.

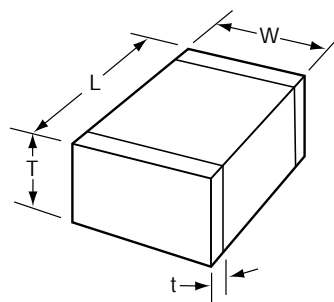

DIMENSIONS

millimeters (inches)

SIZE	0805	1206	1210*	1808*	1812*	1825*	2220*	2225*
(L) Length	2.01 ± 0.20 (0.079 ± 0.008)	3.20 ± 0.20 (0.126 ± 0.008)	3.20 ± 0.20 (0.126 ± 0.008)	4.57 ± 0.25 (0.180 ± 0.010)	4.50 ± 0.30 (0.177 ± 0.012)	4.50 ± 0.30 (0.177 ± 0.012)	5.7 ± 0.40 (0.224 ± 0.016)	5.72 ± 0.25 (0.225 ± 0.010)
(W) Width	1.25 ± 0.20 (0.049 ± 0.008)	1.60 ± 0.20 (0.063 ± 0.008)	2.50 ± 0.20 (0.098 ± 0.008)	2.03 ± 0.25 (0.080 ± 0.010)	3.20 ± 0.20 (0.126 ± 0.008)	6.40 ± 0.30 (0.252 ± 0.012)	5.0 ± 0.40 (0.197 ± 0.016)	6.35 ± 0.25 (0.250 ± 0.010)
(T) Thickness Max.	1.30 (0.051)	1.52 (0.060)	1.70 (0.067)	2.03 (0.080)	2.54 (0.100)	2.54 (0.100)	3.30 (0.130)	2.54 (0.100)
(t) terminal min. max.	0.50 ± 0.25 (0.020 ± 0.010)	0.25 (0.010) 0.75 (0.030)	0.25 (0.010) 0.75 (0.030)	0.25 (0.010) 1.02 (0.040)	0.25 (0.010) 1.02 (0.040)	0.25 (0.010) 1.02 (0.040)	0.25 (0.010) 1.02 (0.040)	0.25 (0.010) 1.02 (0.040)

*Reflow Soldering Only



High Voltage MLC Chips FLEXITERM®



For 600V to 5000V Applications

C0G Dielectric

Performance Characteristics

Capacitance Range	10 pF to 0.018 μ F (25°C, 1.0 \pm 0.2 Vrms at 1kHz, for \leq 1000 pF use 1 MHz)
Capacitance Tolerances	\pm 5%, \pm 10%, \pm 20%
Dissipation Factor	0.1% max. (+25°C, 1.0 \pm 0.2 Vrms, 1kHz, for \leq 1000 pF use 1 MHz)
Operating Temperature Range	-55°C to +125°C
Temperature Characteristic	0 \pm 30 ppm/°C (0 VDC)
Voltage Ratings	600, 630, 1000, 1500, 2000, 2500, 3000, 4000 & 5000 VDC (+125°C)
Insulation Resistance (+25°C, at 500 VDC)	100K M Ω min. or 1000 M Ω - μ F min., whichever is less
Insulation Resistance (+125°C, at 500 VDC)	10K M Ω min. or 100 M Ω - μ F min., whichever is less
Dielectric Strength	Minimum 120% rated voltage for 5 seconds at 50 mA max. current

HIGH VOLTAGE C0G CAPACITANCE VALUES

VOLTAGE	0805	1206	1210	1808	1812	1825	2220	2225
600/630 min.	10pF	10 pF	100 pF	100 pF	100 pF	1000 pF	1000 pF	1000 pF
600/630 max.	330pF	1200 pF	2700 pF	3300 pF	5600 pF	0.012 μ F	0.012 μ F	0.018 μ F
1000 min.	10pF	10 pF	10 pF	100 pF	100 pF	100 pF	1000 pF	1000 pF
1000 max.	180pF	560 pF	1500 pF	2200 pF	3300 pF	8200 pF	0.010 μ F	0.010 μ F
1500 min.	—	10 pF	10 pF	10 pF	10 pF	100 pF	100 pF	100 pF
1500 max.	—	270 pF	680 pF	820 pF	1800 pF	4700 pF	4700 pF	5600 pF
2000 min.	—	10 pF	10 pF	10 pF	10 pF	100 pF	100 pF	100 pF
2000 max.	—	120 pF	270 pF	330 pF	1000 pF	1800 pF	2200 pF	2700 pF
2500 min.	—	—	—	10 pF	10 pF	10 pF	100 pF	100 pF
2500 max.	—	—	—	180 pF	470 pF	1200 pF	1500 pF	1800 pF
3000 min.	—	—	—	10 pF	10 pF	10 pF	10 pF	10 pF
3000 max.	—	—	—	120 pF	330 pF	820 pF	1000 pF	1200 pF
4000 min.	—	—	—	10 pF	10 pF	10 pF	10 pF	10 pF
4000 max.	—	—	—	47 pF	150 pF	330 pF	470 pF	560 pF
5000 min.	—	—	—	—	—	—	10 pF	10 pF
5000 max.	—	—	—	—	—	—	220 pF	270 pF

X7R Dielectric

Performance Characteristics

Capacitance Range	10 pF to 0.33 μ F (25°C, 1.0 \pm 0.2 Vrms at 1kHz)
Capacitance Tolerances	\pm 10%; \pm 20%; +80%, -20%
Dissipation Factor	2.5% max. (+25°C, 1.0 \pm 0.2 Vrms, 1kHz)
Operating Temperature Range	-55°C to +125°C
Temperature Characteristic	\pm 15% (0 VDC)
Voltage Ratings	600, 630, 1000, 1500, 2000, 2500, 3000, 4000 & 5000 VDC (+125°C)
Insulation Resistance (+25°C, at 500 VDC)	100K M Ω min. or 1000 M Ω - μ F min., whichever is less
Insulation Resistance (+125°C, at 500 VDC)	10K M Ω min. or 100 M Ω - μ F min., whichever is less
Dielectric Strength	Minimum 120% rated voltage for 5 seconds at 50 mA max. current

HIGH VOLTAGE X7R MAXIMUM CAPACITANCE VALUES

VOLTAGE	0805	1206	1210	1808	1812	1825	2220	2225
600/630 min.	100pF	1000 pF	1000 pF	1000 pF	1000 pF	0.010 μ F	0.010 μ F	0.010 μ F
600/630 max.	6800pF	0.022 μ F	0.056 μ F	0.068 μ F	0.120 μ F	0.270 μ F	0.270 μ F	0.330 μ F
1000 min.	100pF	100 pF	1000 pF	1000 pF	1000 pF	1000 pF	1000 pF	1000 pF
1000 max.	1500pF	6800 pF	0.015 μ F	0.018 μ F	0.039 μ F	0.100 μ F	0.120 μ F	0.150 μ F
1500 min.	—	100 pF	100 pF	100 pF	100 pF	1000 pF	1000 pF	1000 pF
1500 max.	—	2700 pF	5600 pF	6800 pF	0.015 μ F	0.056 μ F	0.056 μ F	0.068 μ F
2000 min.	—	10 pF	100 pF	100 pF	100 pF	100 pF	1000 pF	1000 pF
2000 max.	—	1500 pF	3300 pF	3300 pF	8200 pF	0.022 μ F	0.027 μ F	0.033 μ F
2500 min.	—	—	—	10 pF	10 pF	100 pF	100 pF	100 pF
2500 max.	—	—	—	2200 pF	5600 pF	0.015 μ F	0.018 μ F	0.022 μ F
3000 min.	—	—	—	10 pF	10 pF	100 pF	100 pF	100 pF
3000 max.	—	—	—	1800 pF	3900 pF	0.010 pF	0.012 μ F	0.015 μ F

MIL-PRF-55681/Chips

Part Number Example
CDR01 thru CDR06

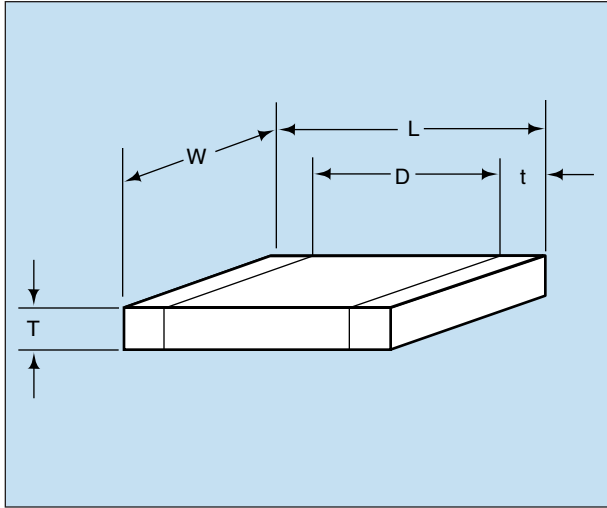

MILITARY DESIGNATION PER MIL-PRF-55681

Part Number Example

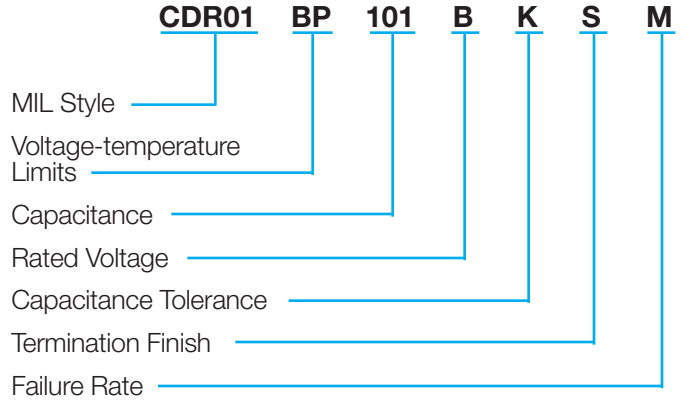

NOTE: Contact factory for availability of Termination and Tolerance Options for Specific Part Numbers.

MIL Style: CDR01, CDR02, CDR03, CDR04, CDR05, CDR06

Voltage Temperature Limits:

BP = 0 ± 30 ppm/°C without voltage; 0 ± 30 ppm/°C with rated voltage from -55°C to +125°C

BX = $\pm 15\%$ without voltage; +15 -25% with rated voltage from -55°C to +125°C

Capacitance: Two digit figures followed by multiplier (number of zeros to be added) e.g., 101 = 100 pF

Rated Voltage: A = 50V, B = 100V

Capacitance Tolerance: J $\pm 5\%$, K $\pm 10\%$, M $\pm 20\%$

Termination Finish:

M = Palladium Silver
 N = Silver Nickel Gold
 S = Solder-coated

U = Base Metallization/Barrier Metal/Solder Coated*
 W = Base Metallization/Barrier Metal/Tinned (Tin or Tin/Lead Alloy)

*Solder shall have a melting point of 200°C or less.

Failure Rate Level: M = 1.0%, P = .1%, R = .01%, S = .001%

Packaging: Bulk is standard packaging. Tape and reel per RS481 is available upon request.

Not RoHS Compliant

CROSS REFERENCE: AVX/MIL-PRF-55681/CDR01 THRU CDR06*

Per MIL-PRF-55681	AVX Style	Length (L)	Width (W)	Thickness (T)		D		Termination Band (t)	
				Min.	Max.	Min.	Max.	Min.	Max.
CDR01	0805	.080 \pm .015	.050 \pm .015	.022	.055	.030	—	.010	—
CDR02	1805	.180 \pm .015	.050 \pm .015	.022	.055	—	—	.010	.030
CDR03	1808	.180 \pm .015	.080 \pm .018	.022	.080	—	—	.010	.030
CDR04	1812	.180 \pm .015	.125 \pm .015	.022	.080	—	—	.010	.030
CDR05	1825	.180 $^{+.020}_{-.015}$.250 $^{+.020}_{-.015}$.020	.080	—	—	.010	.030
CDR06	2225	.225 \pm .020	.250 \pm .020	.020	.080	—	—	.010	.030

*For CDR11, 12, 13, and 14 see AVX Microwave Chip Capacitor Catalog

MIL-PRF-55681/Chips

Military Part Number Identification

CDR01 thru CDR06



CDR01 thru CDR06 to MIL-PRF-55681

Military Type Designation	Capacitance in pF	Capacitance tolerance	Rated temperature and voltage-temperature limits	WVDC
AVX Style 0805/CDR01				
CDR01BP100B---	10	J,K	BP	100
CDR01BP120B---	12	J	BP	100
CDR01BP150B---	15	J,K	BP	100
CDR01BP180B---	18	J	BP	100
CDR01BP220B---	22	J,K	BP	100
CDR01BP270B---	27	J	BP	100
CDR01BP330B---	33	J,K	BP	100
CDR01BP390B---	39	J	BP	100
CDR01BP470B---	47	J,K	BP	100
CDR01BP560B---	56	J	BP	100
CDR01BP680B---	68	J,K	BP	100
CDR01BP820B---	82	J	BP	100
CDR01BP101B---	100	J,K	BP	100
CDR01B--121B---	120	J,K	BP,BX	100
CDR01B--151B---	150	J,K	BP,BX	100
CDR01B--181B---	180	J,K	BP,BX	100
CDR01BX221B---	220	K,M	BX	100
CDR01BX271B---	270	K	BX	100
CDR01BX331B---	330	K,M	BX	100
CDR01BX391B---	390	K	BX	100
CDR01BX471B---	470	K,M	BX	100
CDR01BX561B---	560	K	BX	100
CDR01BX681B---	680	K,M	BX	100
CDR01BX821B---	820	K	BX	100
CDR01BX102B---	1000	K,M	BX	100
CDR01BX122B---	1200	K	BX	100
CDR01BX152B---	1500	K,M	BX	100
CDR01BX182B---	1800	K	BX	100
CDR01BX222B---	2200	K,M	BX	100
CDR01BX272B---	2700	K	BX	100
CDR01BX332B---	3300	K,M	BX	100
CDR01BX392A---	3900	K	BX	50
CDR01BX472A---	4700	K,M	BX	50
AVX Style 1805/CDR02				
CDR02BP221B---	220	J,K	BP	100
CDR02BP271B---	270	J	BP	100
CDR02BX392B---	3900	K	BX	100
CDR02BX472B---	4700	K,M	BX	100
CDR02BX562B---	5600	K	BX	100
CDR02BX682B---	6800	K,M	BX	100
CDR02BX822B---	8200	K	BX	100
CDR02BX103B---	10,000	K,M	BX	100
CDR02BX123A---	12,000	K	BX	50
CDR02BX153A---	15,000	K,M	BX	50
CDR02BX183A---	18,000	K	BX	50
CDR02BX223A---	22,000	K,M	BX	50

- Add appropriate failure rate
- Add appropriate termination finish
- Capacitance Tolerance

Military Type Designation	Capacitance in pF	Capacitance tolerance	Rated temperature and voltage-temperature limits	WVDC
AVX Style 1808/CDR03				
CDR03BP331B---	330	J,K	BP	100
CDR03BP391B---	390	J	BP	100
CDR03BP471B---	470	J,K	BP	100
CDR03BP561B---	560	J	BP	100
CDR03BP681B---	680	J,K	BP	100
CDR03BP821B---	820	J	BP	100
CDR03BP102B---	1000	J,K	BP	100
CDR03BX123B---	12,000	K	BX	100
CDR03BX153B---	15,000	K,M	BX	100
CDR03BX183B---	18,000	K	BX	100
CDR03BX223B---	22,000	K,M	BX	100
CDR03BX273B---	27,000	K	BX	100
CDR03BX333B---	33,000	K,M	BX	100
CDR03BX393A---	39,000	K	BX	50
CDR03BX473A---	47,000	K,M	BX	50
CDR03BX563A---	56,000	K	BX	50
CDR03BX683A---	68,000	K,M	BX	50
AVX Style 1812/CDR04				
CDR04BP122B---	1200	J	BP	100
CDR04BP152B---	1500	J,K	BP	100
CDR04BP182B---	1800	J	BP	100
CDR04BP222B---	2200	J,K	BP	100
CDR04BP272B---	2700	J	BP	100
CDR04BP332B---	3300	J,K	BP	100
CDR04BX393B---	39,000	K	BX	100
CDR04BX473B---	47,000	K,M	BX	100
CDR04BX563B---	56,000	K	BX	100
CDR04BX823A---	82,000	K	BX	50
CDR04BX104A---	100,000	K,M	BX	50
CDR04BX124A---	120,000	K	BX	50
CDR04BX154A---	150,000	K,M	BX	50
CDR04BX184A---	180,000	K	BX	50
AVX Style 1825/CDR05				
CDR05BP392B---	3900	J,K	BP	100
CDR05BP472B---	4700	J,K	BP	100
CDR05BP562B---	5600	J,K	BP	100
CDR05BX683B---	68,000	K,M	BX	100
CDR05BX823B---	82,000	K	BX	100
CDR05BX104B---	100,000	K,M	BX	100
CDR05BX124B---	120,000	K	BX	100
CDR05BX154B---	150,000	K,M	BX	100
CDR05BX224A---	220,000	K,M	BX	50
CDR05BX274A---	270,000	K	BX	50
CDR05BX334A---	330,000	K,M	BX	50
AVX Style 2225/CDR06				
CDR06BP682B---	6800	J,K	BP	100
CDR06BP822B---	8200	J,K	BP	100
CDR06BP103B---	10,000	J,K	BP	100
CDR06BX394A---	390,000	K	BX	50
CDR06BX474A---	470,000	K,M	BX	50

- Add appropriate failure rate
- Add appropriate termination finish
- Capacitance Tolerance



MIL-PRF-55681/Chips

Part Number Example

CDR31 thru CDR35

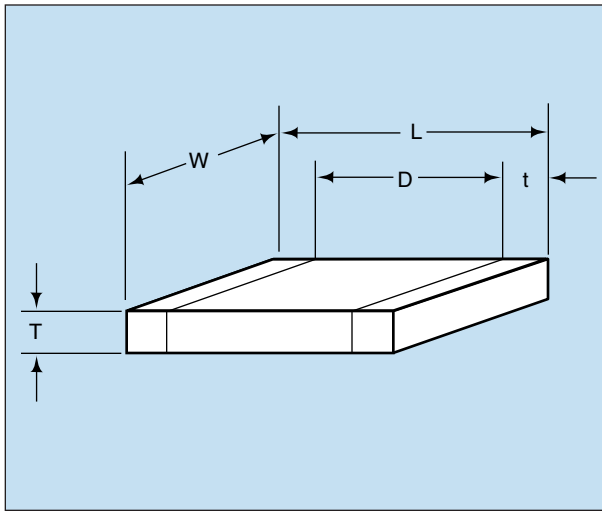

MILITARY DESIGNATION PER MIL-PRF-55681

Part Number Example

(example) **CDR31 BP 101 B K S M**

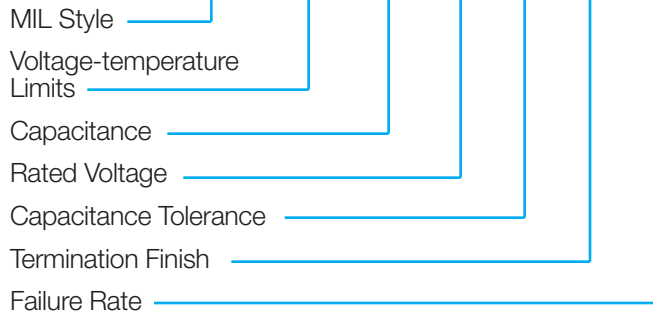

NOTE: Contact factory for availability of Termination and Tolerance Options for Specific Part Numbers.

MIL Style: CDR31, CDR32, CDR33, CDR34, CDR35

Voltage Temperature Limits:

BP = 0 ± 30 ppm/°C without voltage; 0 ± 30 ppm/°C with rated voltage from -55°C to +125°C

BX = $\pm 15\%$ without voltage; +15 -25% with rated voltage from -55°C to +125°C

Capacitance: Two digit figures followed by multiplier (number of zeros to be added) e.g., 101 = 100 pF

Rated Voltage: A = 50V, B = 100V

Capacitance Tolerance: B $\pm .10$ pF, C $\pm .25$ pF, D $\pm .5$ pF, F $\pm 1\%$, J $\pm 5\%$, K $\pm 10\%$, M $\pm 20\%$

Termination Finish:

M = Palladium Silver
N = Silver Nickel Gold
S = Solder-coated
Y = 100% Tin

U = Base Metallization/Barrier Metal/Solder Coated*
W = Base Metallization/Barrier Metal/Tinned (Tin or Tin/Lead Alloy)

*Solder shall have a melting point of 200°C or less.

Failure Rate Level: M = 1.0%, P = .1%, R = .01%, S = .001%

Packaging: Bulk is standard packaging. Tape and reel per RS481 is available upon request.

Not RoHS Compliant

CROSS REFERENCE: AVX/MIL-PRF-55681/CDR31 THRU CDR35

Per MIL-PRF-55681 (Metric Sizes)	AVX Style	Length (L) (mm)	Width (W) (mm)	Thickness (T)	D	Termination Band (t)	
				Max. (mm)		Min. (mm)	Max. (mm)
CDR31	0805	2.00	1.25	1.3	.50	.70	.30
CDR32	1206	3.20	1.60	1.3	—	.70	.30
CDR33	1210	3.20	2.50	1.5	—	.70	.30
CDR34	1812	4.50	3.20	1.5	—	.70	.30
CDR35	1825	4.50	6.40	1.5	—	.70	.30

Military Part Number Identification CDR31

CDR31 to MIL-PRF-55681/7

Military Type Designation 1/	Capacitance in pF	Capacitance tolerance	Rated temperature and voltage-temperature limits	WVDC
AVX Style 0805/CDR31 (BP)				
CDR31BP1R0B---	1.0	B,C	BP	100
CDR31BP1R1B---	1.1	B,C	BP	100
CDR31BP1R2B---	1.2	B,C	BP	100
CDR31BP1R3B---	1.3	B,C	BP	100
CDR31BP1R5B---	1.5	B,C	BP	100
CDR31BP1R6B---	1.6	B,C	BP	100
CDR31BP1R8B---	1.8	B,C	BP	100
CDR31BP2R0B---	2.0	B,C	BP	100
CDR31BP2R2B---	2.2	B,C	BP	100
CDR31BP2R4B---	2.4	B,C	BP	100
CDR31BP2R7B---	2.7	B,C,D	BP	100
CDR31BP3R0B---	3.0	B,C,D	BP	100
CDR31BP3R3B---	3.3	B,C,D	BP	100
CDR31BP3R6B---	3.6	B,C,D	BP	100
CDR31BP3R9B---	3.9	B,C,D	BP	100
CDR31BP4R3B---	4.3	B,C,D	BP	100
CDR31BP4R7B---	4.7	B,C,D	BP	100
CDR31BP5R1B---	5.1	B,C,D	BP	100
CDR31BP5R6B---	5.6	B,C,D	BP	100
CDR31BP6R2B---	6.2	B,C,D	BP	100
CDR31BP6R8B---	6.8	B,C,D	BP	100
CDR31BP7R5B---	7.5	B,C,D	BP	100
CDR31BP8R2B---	8.2	B,C,D	BP	100
CDR31BP9R1B---	9.1	B,C,D	BP	100
CDR31BP100B---	10	F,J,K	BP	100
CDR31BP110B---	11	F,J,K	BP	100
CDR31BP120B---	12	F,J,K	BP	100
CDR31BP130B---	13	F,J,K	BP	100
CDR31BP150B---	15	F,J,K	BP	100
CDR31BP160B---	16	F,J,K	BP	100
CDR31BP180B---	18	F,J,K	BP	100
CDR31BP200B---	20	F,J,K	BP	100
CDR31BP220B---	22	F,J,K	BP	100
CDR31BP240B---	24	F,J,K	BP	100
CDR31BP270B---	27	F,J,K	BP	100
CDR31BP300B---	30	F,J,K	BP	100
CDR31BP330B---	33	F,J,K	BP	100
CDR31BP360B---	36	F,J,K	BP	100
CDR31BP390B---	39	F,J,K	BP	100
CDR31BP430B---	43	F,J,K	BP	100
CDR31BP470B---	47	F,J,K	BP	100
CDR31BP510B---	51	F,J,K	BP	100
CDR31BP560B---	56	F,J,K	BP	100
CDR31BP620B---	62	F,J,K	BP	100
CDR31BP680B---	68	F,J,K	BP	100
CDR31BP750B---	75	F,J,K	BP	100
CDR31BP820B---	82	F,J,K	BP	100
CDR31BP910B---	91	F,J,K	BP	100

— Add appropriate failure rate
 — Add appropriate termination finish
 — Capacitance Tolerance

Military Type Designation 1/	Capacitance in pF	Capacitance tolerance	Rated temperature and voltage-temperature limits	WVDC
AVX Style 0805/CDR31 (BP) cont'd				
CDR31BP101B---	100	F,J,K	BP	100
CDR31BP111B---	110	F,J,K	BP	100
CDR31BP121B---	120	F,J,K	BP	100
CDR31BP131B---	130	F,J,K	BP	100
CDR31BP151B---	150	F,J,K	BP	100
CDR31BP161B---	160	F,J,K	BP	100
CDR31BP181B---	180	F,J,K	BP	100
CDR31BP201B---	200	F,J,K	BP	100
CDR31BP221B---	220	F,J,K	BP	100
CDR31BP241B---	240	F,J,K	BP	100
CDR31BP271B---	270	F,J,K	BP	100
CDR31BP301B---	300	F,J,K	BP	100
CDR31BP331B---	330	F,J,K	BP	100
CDR31BP361B---	360	F,J,K	BP	100
CDR31BP391B---	390	F,J,K	BP	100
CDR31BP431B---	430	F,J,K	BP	100
CDR31BP471B---	470	F,J,K	BP	100
CDR31BP511A---	510	F,J,K	BP	50
CDR31BP561A---	560	F,J,K	BP	50
CDR31BP621A---	620	F,J,K	BP	50
CDR31BP681A---	680	F,J,K	BP	50
AVX Style 0805/CDR31 (BX)				
CDR31BX471B---	470	K,M	BX	100
CDR31BX561B---	560	K,M	BX	100
CDR31BX681B---	680	K,M	BX	100
CDR31BX821B---	820	K,M	BX	100
CDR31BX102B---	1,000	K,M	BX	100
CDR31BX122B---	1,200	K,M	BX	100
CDR31BX152B---	1,500	K,M	BX	100
CDR31BX182B---	1,800	K,M	BX	100
CDR31BX222B---	2,200	K,M	BX	100
CDR31BX272B---	2,700	K,M	BX	100
CDR31BX332B---	3,300	K,M	BX	100
CDR31BX392B---	3,900	K,M	BX	100
CDR31BX472B---	4,700	K,M	BX	100
CDR31BX562A---	5,600	K,M	BX	50
CDR31BX682A---	6,800	K,M	BX	50
CDR31BX822A---	8,200	K,M	BX	50
CDR31BX103A---	10,000	K,M	BX	50
CDR31BX123A---	12,000	K,M	BX	50
CDR31BX153A---	15,000	K,M	BX	50
CDR31BX183A---	18,000	K,M	BX	50

— Add appropriate failure rate
 — Add appropriate termination finish
 — Capacitance Tolerance

1/ The complete part number will include additional symbols to indicate capacitance tolerance, termination and failure rate level.

MIL-PRF-55681/Chips



Military Part Number Identification CDR32

CDR32 to MIL-PRF-55681/8

Military Type Designation ^{1/}	Capacitance in pF	Capacitance tolerance	Rated temperature and voltage-temperature limits	WVDC
AVX Style 1206/CDR32 (BP)				
CDR32BP1R0B---	1.0	B,C	BP	100
CDR32BP1R1B---	1.1	B,C	BP	100
CDR32BP1R2B---	1.2	B,C	BP	100
CDR32BP1R3B---	1.3	B,C	BP	100
CDR32BP1R5B---	1.5	B,C	BP	100
CDR32BP1R6B---	1.6	B,C	BP	100
CDR32BP1R8B---	1.8	B,C	BP	100
CDR32BP2R0B---	2.0	B,C	BP	100
CDR32BP2R2B---	2.2	B,C	BP	100
CDR32BP2R4B---	2.4	B,C	BP	100
CDR32BP2R7B---	2.7	B,C,D	BP	100
CDR32BP3R0B---	3.0	B,C,D	BP	100
CDR32BP3R3B---	3.3	B,C,D	BP	100
CDR32BP3R6B---	3.6	B,C,D	BP	100
CDR32BP3R9B---	3.9	B,C,D	BP	100
CDR32BP4R3B---	4.3	B,C,D	BP	100
CDR32BP4R7B---	4.7	B,C,D	BP	100
CDR32BP5R1B---	5.1	B,C,D	BP	100
CDR32BP5R6B---	5.6	B,C,D	BP	100
CDR32BP6R2B---	6.2	B,C,D	BP	100
CDR32BP6R8B---	6.8	B,C,D	BP	100
CDR32BP7R5B---	7.5	B,C,D	BP	100
CDR32BP8R2B---	8.2	B,C,D	BP	100
CDR32BP9R1B---	9.1	B,C,D	BP	100
CDR32BP100B---	10	F,J,K	BP	100
CDR32BP110B---	11	F,J,K	BP	100
CDR32BP120B---	12	F,J,K	BP	100
CDR32BP130B---	13	F,J,K	BP	100
CDR32BP150B---	15	F,J,K	BP	100
CDR32BP160B---	16	F,J,K	BP	100
CDR32BP180B---	18	F,J,K	BP	100
CDR32BP200B---	20	F,J,K	BP	100
CDR32BP220B---	22	F,J,K	BP	100
CDR32BP240B---	24	F,J,K	BP	100
CDR32BP270B---	27	F,J,K	BP	100
CDR32BP300B---	30	F,J,K	BP	100
CDR32BP330B---	33	F,J,K	BP	100
CDR32BP360B---	36	F,J,K	BP	100
CDR32BP390B---	39	F,J,K	BP	100
CDR32BP430B---	43	F,J,K	BP	100
CDR32BP470B---	47	F,J,K	BP	100
CDR32BP510B---	51	F,J,K	BP	100
CDR32BP560B---	56	F,J,K	BP	100
CDR32BP620B---	62	F,J,K	BP	100
CDR32BP680B---	68	F,J,K	BP	100
CDR32BP750B---	75	F,J,K	BP	100
CDR32BP820B---	82	F,J,K	BP	100
CDR32BP910B---	91	F,J,K	BP	100

- Add appropriate failure rate
- Add appropriate termination finish
- Capacitance Tolerance

Military Type Designation ^{1/}	Capacitance in pF	Capacitance tolerance	Rated temperature and voltage-temperature limits	WVDC
AVX Style 1206/CDR32 (BP) cont'd				
CDR32BP101B---	100	F,J,K	BP	100
CDR32BP111B---	110	F,J,K	BP	100
CDR32BP121B---	120	F,J,K	BP	100
CDR32BP131B---	130	F,J,K	BP	100
CDR32BP151B---	150	F,J,K	BP	100
CDR32BP161B---	160	F,J,K	BP	100
CDR32BP181B---	180	F,J,K	BP	100
CDR32BP201B---	200	F,J,K	BP	100
CDR32BP221B---	220	F,J,K	BP	100
CDR32BP241B---	240	F,J,K	BP	100
CDR32BP271B---	270	F,J,K	BP	100
CDR32BP301B---	300	F,J,K	BP	100
CDR32BP331B---	330	F,J,K	BP	100
CDR32BP361B---	360	F,J,K	BP	100
CDR32BP391B---	390	F,J,K	BP	100
CDR32BP431B---	430	F,J,K	BP	100
CDR32BP471B---	470	F,J,K	BP	100
CDR32BP511B---	510	F,J,K	BP	100
CDR32BP561B---	560	F,J,K	BP	100
CDR32BP621B---	620	F,J,K	BP	100
CDR32BP681B---	680	F,J,K	BP	100
CDR32BP751B---	750	F,J,K	BP	100
CDR32BP821B---	820	F,J,K	BP	100
CDR32BP911B---	910	F,J,K	BP	100
CDR32BP102B---	1,000	F,J,K	BP	100
CDR32BP112A---	1,100	F,J,K	BP	50
CDR32BP122A---	1,200	F,J,K	BP	50
CDR32BP132A---	1,300	F,J,K	BP	50
CDR32BP152A---	1,500	F,J,K	BP	50
CDR32BP162A---	1,600	F,J,K	BP	50
CDR32BP182A---	1,800	F,J,K	BP	50
CDR32BP202A---	2,000	F,J,K	BP	50
CDR32BP222A---	2,200	F,J,K	BP	50
AVX Style 1206/CDR32 (BX)				
CDR32BX472B---	4,700	K,M	BX	100
CDR32BX562B---	5,600	K,M	BX	100
CDR32BX682B---	6,800	K,M	BX	100
CDR32BX822B---	8,200	K,M	BX	100
CDR32BX103B---	10,000	K,M	BX	100
CDR32BX123B---	12,000	K,M	BX	100
CDR32BX153B---	15,000	K,M	BX	100
CDR32BX183A---	18,000	K,M	BX	50
CDR32BX223A---	22,000	K,M	BX	50
CDR32BX273A---	27,000	K,M	BX	50
CDR32BX333A---	33,000	K,M	BX	50
CDR32BX393A---	39,000	K,M	BX	50

- Add appropriate failure rate
- Add appropriate termination finish
- Capacitance Tolerance

^{1/} The complete part number will include additional symbols to indicate capacitance tolerance, termination and failure rate level.

CDR33/34/35 to MIL-PRF-55681/9/10/11

Military Type Designation ^{1/}	Capacitance in pF	Capacitance tolerance	Rated temperature and voltage-temperature limits	WVDC
AVX Style 1210/CDR33 (BP)				
CDR33BP102B---	1,000	F,J,K	BP	100
CDR33BP112B---	1,100	F,J,K	BP	100
CDR33BP122B---	1,200	F,J,K	BP	100
CDR33BP132B---	1,300	F,J,K	BP	100
CDR33BP152B---	1,500	F,J,K	BP	100
CDR33BP162B---	1,600	F,J,K	BP	100
CDR33BP182B---	1,800	F,J,K	BP	100
CDR33BP202B---	2,000	F,J,K	BP	100
CDR33BP222B---	2,200	F,J,K	BP	100
CDR33BP242A---	2,400	F,J,K	BP	50
CDR33BP272A---	2,700	F,J,K	BP	50
CDR33BP302A---	3,000	F,J,K	BP	50
CDR33BP332A---	3,300	F,J,K	BP	50
AVX Style 1210/CDR33 (BX)				
CDR33BX153B---	15,000	K,M	BX	100
CDR33BX183B---	18,000	K,M	BX	100
CDR33BX223B---	22,000	K,M	BX	100
CDR33BX273B---	27,000	K,M	BX	100
CDR33BX393A---	39,000	K,M	BX	50
CDR33BX473A---	47,000	K,M	BX	50
CDR33BX563A---	56,000	K,M	BX	50
CDR33BX683A---	68,000	K,M	BX	50
CDR33BX823A---	82,000	K,M	BX	50
CDR33BX104A---	100,000	K,M	BX	50
AVX Style 1812/CDR34 (BP)				
CDR34BP222B---	2,200	F,J,K	BP	100
CDR34BP242B---	2,400	F,J,K	BP	100
CDR34BP272B---	2,700	F,J,K	BP	100
CDR34BP302B---	3,000	F,J,K	BP	100
CDR34BP332B---	3,300	F,J,K	BP	100
CDR34BP362B---	3,600	F,J,K	BP	100
CDR34BP392B---	3,900	F,J,K	BP	100
CDR34BP432B---	4,300	F,J,K	BP	100
CDR34BP472B---	4,700	F,J,K	BP	100
CDR34BP512A---	5,100	F,J,K	BP	50
CDR34BP562A---	5,600	F,J,K	BP	50
CDR34BP622A---	6,200	F,J,K	BP	50
CDR34BP682A---	6,800	F,J,K	BP	50
CDR34BP752A---	7,500	F,J,K	BP	50
CDR34BP822A---	8,200	F,J,K	BP	50
CDR34BP912A---	9,100	F,J,K	BP	50
CDR34BP103A---	10,000	F,J,K	BP	50

- Add appropriate failure rate
- Add appropriate termination finish
- Capacitance Tolerance

Military Type Designation ^{1/}	Capacitance in pF	Capacitance tolerance	Rated temperature and voltage-temperature limits	WVDC
AVX Style 1812/CDR34 (BX)				
CDR34BX273B---	27,000	K,M	BX	100
CDR34BX333B---	33,000	K,M	BX	100
CDR34BX393B---	39,000	K,M	BX	100
CDR34BX473B---	47,000	K,M	BX	100
CDR34BX563B---	56,000	K,M	BX	100
CDR34BX104A---	100,000	K,M	BX	50
CDR34BX124A---	120,000	K,M	BX	50
CDR34BX154A---	150,000	K,M	BX	50
CDR34BX184A---	180,000	K,M	BX	50
AVX Style 1825/CDR35 (BP)				
CDR35BP472B---	4,700	F,J,K	BP	100
CDR35BP512B---	5,100	F,J,K	BP	100
CDR35BP562B---	5,600	F,J,K	BP	100
CDR35BP622B---	6,200	F,J,K	BP	100
CDR35BP682B---	6,800	F,J,K	BP	100
CDR35BP752B---	7,500	F,J,K	BP	100
CDR35BP822B---	8,200	F,J,K	BP	100
CDR35BP912B---	9,100	F,J,K	BP	100
CDR35BP103B---	10,000	F,J,K	BP	100
CDR35BP113A---	11,000	F,J,K	BP	50
CDR35BP123A---	12,000	F,J,K	BP	50
CDR35BP133A---	13,000	F,J,K	BP	50
CDR35BP153A---	15,000	F,J,K	BP	50
CDR35BP163A---	16,000	F,J,K	BP	50
CDR35BP183A---	18,000	F,J,K	BP	50
CDR35BP203A---	20,000	F,J,K	BP	50
CDR35BP223A---	22,000	F,J,K	BP	50
AVX Style 1825/CDR35 (BX)				
CDR35BX563B---	56,000	K,M	BX	100
CDR35BX683B---	68,000	K,M	BX	100
CDR35BX823B---	82,000	K,M	BX	100
CDR35BX104B---	100,000	K,M	BX	100
CDR35BX124B---	120,000	K,M	BX	100
CDR35BX154B---	150,000	K,M	BX	100
CDR35BX184A---	180,000	K,M	BX	50
CDR35BX224A---	220,000	K,M	BX	50
CDR35BX274A---	270,000	K,M	BX	50
CDR35BX334A---	330,000	K,M	BX	50
CDR35BX394A---	390,000	K,M	BX	50
CDR35BX474A---	470,000	K,M	BX	50

- Add appropriate failure rate
- Add appropriate termination finish
- Capacitance Tolerance

^{1/} The complete part number will include additional symbols to indicate capacitance tolerance, termination and failure rate level.

Packaging of Chip Components



Automatic Insertion Packaging

TAPE & REEL QUANTITIES

All tape and reel specifications are in compliance with RS481.

	8mm	12mm	
Paper or Embossed Carrier	0612, 0508, 0805, 1206, 1210		
Embossed Only		1808	1812, 1825 2220, 2225
Paper Only	0201, 0306, 0402, 0603		
Qty. per Reel/7" Reel	2,000, 3,000 or 4,000, 10,000, 15,000 Contact factory for exact quantity	3,000	500, 1,000 Contact factory for exact quantity
Qty. per Reel/13" Reel	5,000, 10,000, 50,000 Contact factory for exact quantity	10,000	4,000

REEL DIMENSIONS

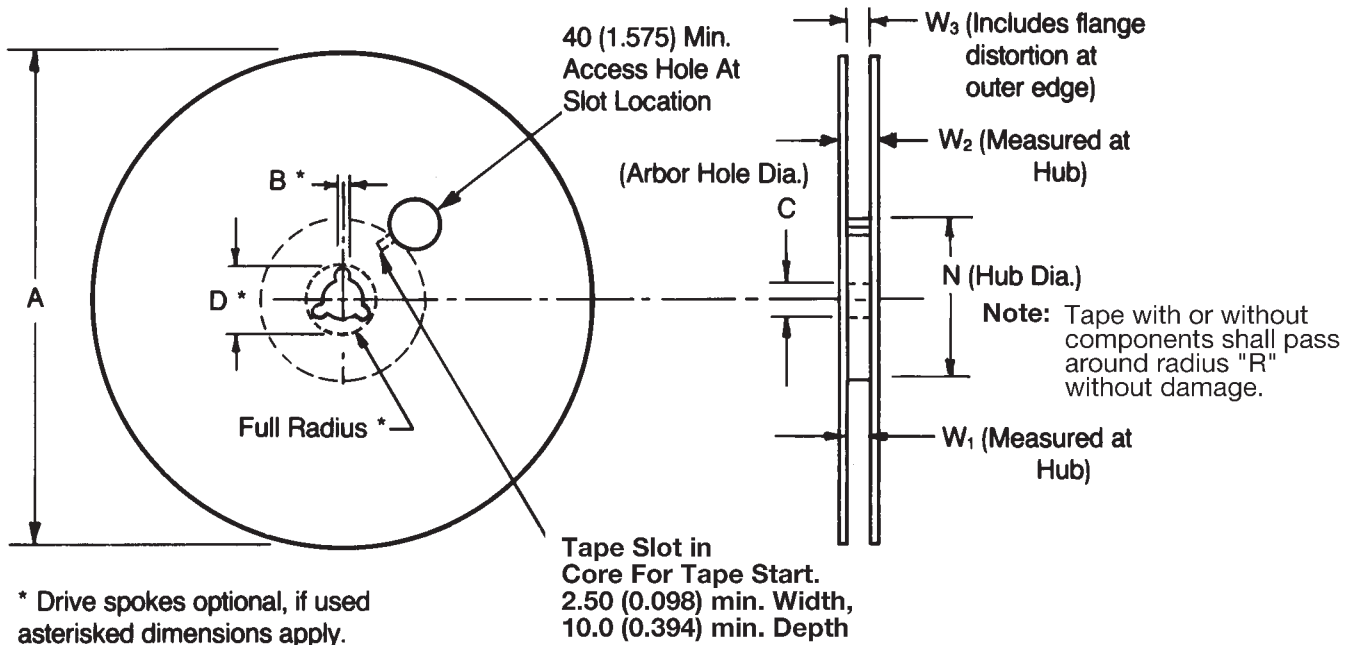

Tape Size ⁽¹⁾	A Max.	B* Min.	C	D* Min.	N Min.	W ₁	W ₂ Max.	W ₃
8mm	330 (12.992)	1.5 (0.059)	13.0 ^{+0.50} _{-0.20} (0.512 ^{+0.020} _{-0.008})	20.2 (0.795)	50.0 (1.969)	8.40 ^{+1.5} _{-0.8} (0.331 ^{+0.059} _{-0.0})	14.4 (0.567)	7.90 Min. (0.311)
12mm						12.4 ^{+2.0} _{-0.0} (0.488 ^{+0.079} _{-0.0})		11.9 Min. (0.469)
								10.9 Max. (0.429)
								15.4 Max. (0.607)

Metric dimensions will govern.

English measurements rounded and for reference only.

(1) For tape sizes 16mm and 24mm (used with chip size 3640) consult EIA RS-481 latest revision.



Embossed Carrier Configuration



8 & 12mm Tape Only

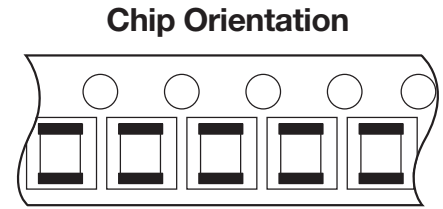
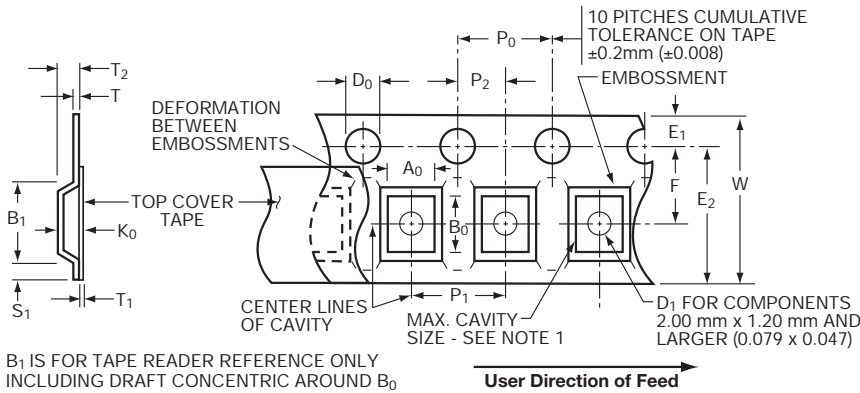

8 & 12mm Embossed Tape Metric Dimensions Will Govern

CONSTANT DIMENSIONS

Tape Size	D ₀	E	P ₀	P ₂	S ₁ Min.	T Max.	T ₁
8mm and 12mm	1.50 ^{+0.10} _{0.0} (0.059 ^{+0.004} _{0.0})	1.75 ± 0.10 (0.069 ± 0.004)	4.0 ± 0.10 (0.157 ± 0.004)	2.0 ± 0.05 (0.079 ± 0.002)	0.60 (0.024)	0.60 (0.024)	0.10 (0.004) Max.

VARIABLE DIMENSIONS

Tape Size	B ₁ Max.	D ₁ Min.	E ₂ Min.	F	P ₁ See Note 5	R Min. See Note 2	T ₂	W Max.	A ₀ B ₀ K ₀
8mm	4.35 (0.171)	1.00 (0.039)	6.25 (0.246)	3.50 ± 0.05 (0.138 ± 0.002)	4.00 ± 0.10 (0.157 ± 0.004)	25.0 (0.984)	2.50 Max. (0.098)	8.30 (0.327)	See Note 1
12mm	8.20 (0.323)	1.50 (0.059)	10.25 (0.404)	5.50 ± 0.05 (0.217 ± 0.002)	4.00 ± 0.10 (0.157 ± 0.004)	30.0 (1.181)	6.50 Max. (0.256)	12.3 (0.484)	See Note 1
8mm 1/2 Pitch	4.35 (0.171)	1.00 (0.039)	6.25 (0.246)	3.50 ± 0.05 (0.138 ± 0.002)	2.00 ± 0.10 (0.079 ± 0.004)	25.0 (0.984)	2.50 Max. (0.098)	8.30 (0.327)	See Note 1
12mm Double Pitch	8.20 (0.323)	1.50 (0.059)	10.25 (0.404)	5.50 ± 0.05 (0.217 ± 0.002)	8.00 ± 0.10 (0.315 ± 0.004)	30.0 (1.181)	6.50 Max. (0.256)	12.3 (0.484)	See Note 1

NOTES:

1. The cavity defined by A₀, B₀, and K₀ shall be configured to provide the following:

Surround the component with sufficient clearance such that:

- the component does not protrude beyond the sealing plane of the cover tape.
- the component can be removed from the cavity in a vertical direction without mechanical restriction, after the cover tape has been removed.
- rotation of the component is limited to 20° maximum (see Sketches D & E).
- lateral movement of the component is restricted to 0.5mm maximum (see Sketch F).

2. Tape with or without components shall pass around radius "R" without damage.

3. Bar code labeling (if required) shall be on the side of the reel opposite the round sprocket holes. Refer to EIA-556.

4. B₁ dimension is a reference dimension for tape feeder clearance only.

5. If P₁ = 2.0mm, the tape may not properly index in all tape feeders.

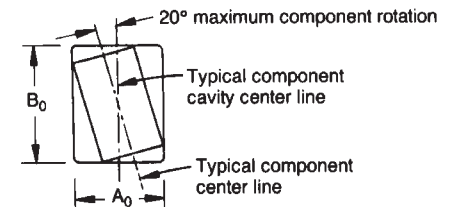
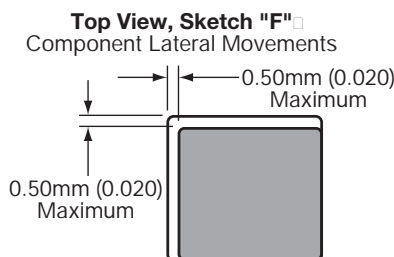
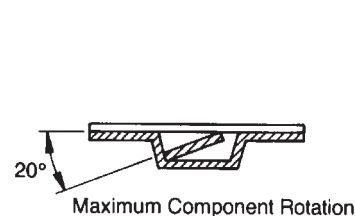

Paper Carrier Configuration



8 & 12mm Tape Only

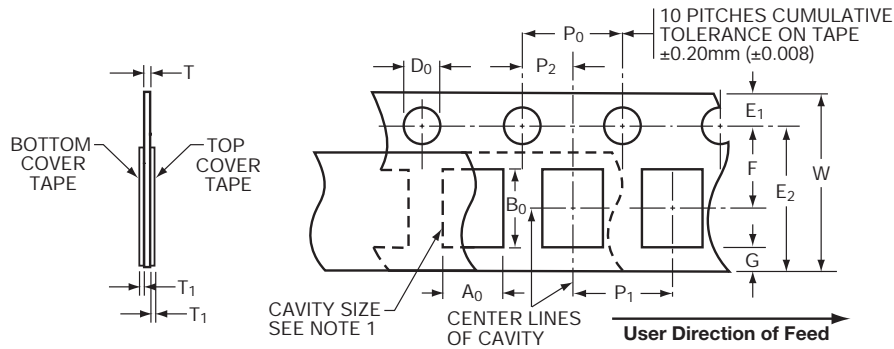

8 & 12mm Paper Tape Metric Dimensions Will Govern

CONSTANT DIMENSIONS

Tape Size	D ₀	E	P ₀	P ₂	T ₁	G. Min.	R Min.
8mm and 12mm	1.50 ^{+0.10} / _{-0.004} (0.059 ^{+0.004} / _{-0.004})	1.75 ± 0.10 (0.069 ± 0.004)	4.00 ± 0.10 (0.157 ± 0.004)	2.00 ± 0.05 (0.079 ± 0.002)	0.10 (0.004) Max.	0.75 (0.030) Min.	25.0 (0.984) See Note 2 Min.

VARIABLE DIMENSIONS

Tape Size	P ₁ See Note 4	E ₂ Min.	F	W	A ₀ B ₀	T
8mm	4.00 ± 0.10 (0.157 ± 0.004)	6.25 (0.246)	3.50 ± 0.05 (0.138 ± 0.002)	8.00 ^{+0.30} / _{-0.10} (0.315 ^{+0.012} / _{-0.004})	See Note 1	1.10mm (0.043) Max. for Paper Base Tape and 1.60mm (0.063) Max. for Non-Paper Base Compositions
12mm	4.00 ± 0.010 (0.157 ± 0.004)	10.25 (0.404)	5.50 ± 0.05 (0.217 ± 0.002)	12.0 ± 0.30 (0.472 ± 0.012)		
8mm 1/2 Pitch	2.00 ± 0.05 (0.079 ± 0.002)	6.25 (0.246)	3.50 ± 0.05 (0.138 ± 0.002)	8.00 ^{+0.30} / _{-0.10} (0.315 ^{+0.012} / _{-0.004})		
12mm Double Pitch	8.00 ± 0.10 (0.315 ± 0.004)	10.25 (0.404)	5.50 ± 0.05 (0.217 ± 0.002)	12.0 ± 0.30 (0.472 ± 0.012)		

NOTES:

- The cavity defined by A₀, B₀, and T shall be configured to provide sufficient clearance surrounding the component so that:
 - the component does not protrude beyond either surface of the carrier tape;
 - the component can be removed from the cavity in a vertical direction without mechanical restriction after the top cover tape has been removed;
 - rotation of the component is limited to 20° maximum (see Sketches A & B);
 - lateral movement of the component is restricted to 0.5mm maximum (see Sketch C).
- Tape with or without components shall pass around radius "R" without damage.
- Bar code labeling (if required) shall be on the side of the reel opposite the sprocket holes. Refer to EIA-556.
- If P₁ = 2.0mm, the tape may not properly index in all tape feeders.

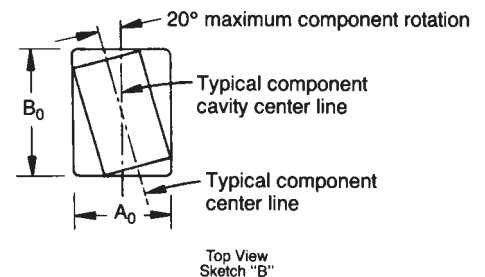
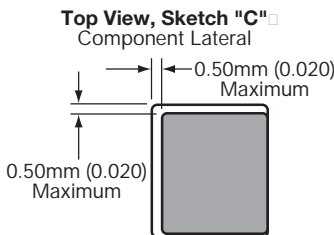
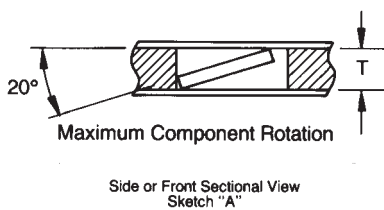

Bar Code Labeling Standard

AVX bar code labeling is available and follows latest version of EIA-556



BENEFITS

- Easier handling
- Smaller packaging volume
(1/20 of T/R packaging)
- Easier inventory control
- Flexibility
- Recyclable

CASE DIMENSIONS

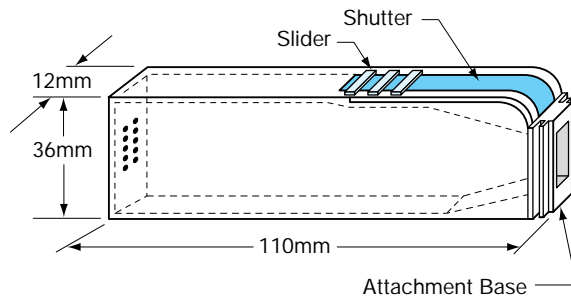

BULK FEEDER

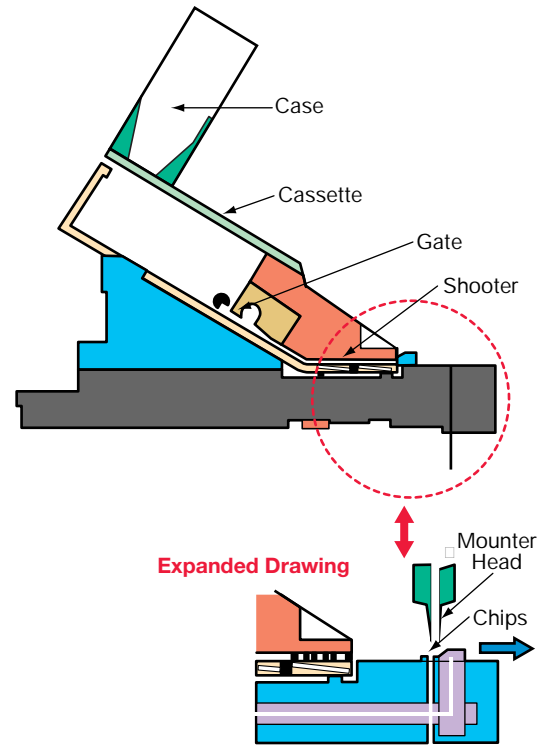

CASE QUANTITIES

Part Size	0402	0603	0805	1206
Qty. (pcs / cassette)	80,000	15,000	10,000 (T=.023") 8,000 (T=.031") 6,000 (T=.043")	5,000 (T=.023") 4,000 (T=.032") 3,000 (T=.044")