

PREPARED BY : DATE	SHARP	SPEC No. LD-20706A
APPROVED BY : DATE		FILE No.
		ISSUE : 12. July. 2008
		PAGE : 18 pages
	MOBILE LIQUID CRYSTAL DISPLAY GROUP SHARP CORPORATION	APPLICABLE GROUP MOBILE LIQUID CRYSTAL DISPLAY GROUP
SPECIFICATION		

DEVICE SPECIFICATION FOR
TFT-LCD Module
 MODEL No.
LQ084V3DG02

Datasheet.Live

These parts have corresponded with the RoHS directive.

CUSTOMER'S APPROVAL
BY _____

BY *K. Shiono*
 K. Shiono
 General manager
 ENGINEERING DEPARTMENT
 MOBILE LIQUID CRYSTAL DISPLAY DIVISION III
 MOBILE LIQUID CRYSTAL DISPLAY GROUP
 SHARP CORPORATION

NOTICE

This publication is the proprietary of SHARP and is copyrighted, with all rights reserved. Under the copyright laws, no part of this publication may be reproduced or transmitted in any form or by any means, electronic or mechanical for any purpose, in whole or in part, without the express written permission of SHARP. Express written permission is also required before any use of this publication may be made by a third party.

The application circuit examples in this publication are provided to explain the representative applications of SHARP's devices and are not intended to guarantee any circuit design or permit any industrial property right or other rights to be executed. SHARP takes no responsibility for any problems related to any industrial property right or a third party resulting from the use of SHARP's devices, except for those resulting directly from device manufacturing processes.

In the absence of confirmation by device specification sheets, SHARP takes no responsibility for any defects that occur in equipment using any of SHARP's devices, shown in catalogs, data books, etc. Contact SHARP in order to obtain the latest device specification sheets before using any SHARP's device.

SHARP reserves the right to make changes in the specifications, characteristics, data, materials, structures and other contents described herein at any time without notice in order to improve design or reliability. Contact SHARP in order to obtain the latest specification sheets before using any SHARP's device. Manufacturing locations are also subject to change without notice.

Observe the following points when using any device in this publication. SHARP takes no responsibility for damage caused by improper use of the devices.

The devices in this publication are designed for general electronic equipment use.

The appropriate design measures should be taken to ensure reliability and safety when SHARP's devices are used for equipment such as:

- Transportation control and safety equipment(i.e.,aircraft, trains, automobiles, etc.)
- Traffic signals • Gas leakage sensor breakers • Alarm equipment • Various safety devices etc.

SHARP's devices shall not be used for equipment that requires extremely high level of reliability, such as:

- Military and space applications • Nuclear power control equipment
- Medical equipment for life support

Contact a SHARP representative, in advance, when intending to use SHARP's devices for any "specific" applications other than those recommended by SHARP.

Contact and consult with a SHARP representative if there are any questions about the contents of this publication.

1 Applicable TFT-LCD module

This specification applies to the color 8.4VGA TFT-LCD module, LQ084V3DG02.

2 Overview

This module is a color active matrix transmissive LCD module incorporating amorphous silicon TFT (Thin Film Transistor).

It is composed of a color TFT-LCD panel, driver ICs, control circuits and power supply circuitry and a backlight unit. Graphics and texts can be displayed on a 640 x RGB x 480 dots panel with 262,144 colors by feeding 18 bit data signal (6bit/each of R,G,B), 4(four) timing signals, +3.3V DC power supply for TFT-LCD and AC power supply for backlight.

(Note: Backlight-driving DC/DC converter and the wire harness are not built in this module.)

- Fine images with stripe aligned 307,200 pixels on 8.4 inch diagonal screen
- Adapting a wide viewing angle technology [best viewing angle: 6 o'clock direction]
- High contrast, thanks to active matrix drive system
- AG(Anti Glare) polarizing filter
- Light and slim compact module (12 o'clock direction is also available by the function to flip the screen horizontally or vertically)
- Natural coloring reproducibility by employing normally-white-mode, which has good nature in coloring
- Image inversion both horizontally and vertically
- This module is adapted to RoHS compliance.

3 Mechanical Specifications

items	specifications	unit
Display size (Diagonal)	21.4 (8.4")	cm
Active display area	170.88 (H) x 128.16 (V)	mm
Pixel format	640(H) x RGB x 480(V)	pixel
	(1 pixel=R+G+B dots)	-
Pixel pitch	0.267 (H) x 0.267(V)	mm
Pixel configuration	R,G,B vertical stripe	-
LCD mode	Normally white/Twisted Nematic	-
Dimension *	199.5 (W) x 149.5 (H) x 11.6(D)	mm
Mass	400 (max)	g

*Fig.1 shows dimensions of the module.

4 Input Signal Assignment

4.1 TFT-LCD Panel driving section

CN1

Used connector: IMSA-9637S-33Y902 (IRISO ELECTRONICS CO.,LTD.)

Pin No.	Symbol	Function	Polarity
1	GND	-	
2	CK	Clock signal for sampling each datum	
3	Hsync	Horizontal Sync signal	Negative
4	Vsync	Vertical Sync signal	Negative
5	GND		
6	R0	RED data signal (LSB)	
7	R1	RED data signal	
8	R2	RED data signal	
9	R3	RED data signal	
10	R4	RED data signal	
11	R5	RED data signal (MSB)	
12	GND		
13	G0	GREEN data signal (LSB)	
14	G1	GREEN data signal	
15	G2	GREEN data signal	
16	G3	GREEN data signal	
17	G4	GREEN data signal	
18	G5	GREEN data signal (MSB)	
19	GND		
20	B0	BLUE data signal (LSB)	
21	B1	BLUE data signal	
22	B2	BLUE data signal	
23	B3	BLUE data signal	
24	B4	BLUE data signal	
25	B5	BLUE data signal (MSB)	
26	GND		
27	ENAB	Data Enable signal (Control signal for image location in horizontal direction)	[Note 4-1]
28	Vcc	Power supply in	
29	Vcc	Power supply in	
30	R/L	Horizontal scanning direction control signal (Rightwards/Leftwards)	[Note 4-2]
31	U/D	Vertical scanning direction control signal (Upwards/downwards)	[Note 4-2]
32	NC		
33	GND		

The front shield case and back shield case is internally grounded to GND of the module.

[Note 4-1]

The horizontal display location is designated and controlled by rising timing of ENAB signal.

However if ENAB signal is fixed to “Low”, display location is designated by the default setting in the module.

(Don't use the module by fixing ENAB to “High”)See: Chapter 7-2

[Note 4-2]



4.2 Backlight section

Used connector: SM04B-SRSS-TB(LF)(SN) (JST)

CN2 Corresponding connector: SHR-04V-S-B (JST)

Pin no.	Symbol	Function
1	+ ch2	Power supply for LED (ch2 High voltage side)
2	+ ch1	Power supply for LED (ch1 High voltage side)
3	- ch1	Power supply for LED (ch1 Low voltage side)
4	- ch2	Power supply for LED (ch2 Low voltage side)

5 Absolute Maximum Ratings

*Ta=Ambient temperature

Parameter	Symbol	Condition	Ratings	Unit	Remark
Input voltage	V _I	Ta=25°C	-0.3 ~ V _{cc} +0.3	V	[Note 5-1]
Supply voltage	V _{cc}	Ta=25°C	0 ~ +4.0	V	-
Storage temperature	T _{stg}	-	-30 ~ +80	°C	[Note 5-2,3,4,5]
Operating temperature (Panel surface)	T _{opp}	-	-30 ~ +80	°C	

[Note 5-1] CK, R0 ~ R5, G0 ~ G5, B0 ~ B5, Hsync, Vsync, ENAB, R/L and U/D

[Note 5-2] Humidity: Less than 95%RH at Ta ≤ 40°C and

Maximum wet-bulb temperature must not exceed 39°C at Ta > 40°C, with no condensation.

[Note 5-3] The operating temperature only guarantees operation of the circuit. For contrast, speed response, and other factors related to display quality, judgment is done using the ambient temperature Ta = + 25°C.

[Note 5-4] This rating applies to all parts of the module and should not be exceeded.

[Note 5-5] Under the environment between 65 and 80 , it may cause display non-uniformity issue, etc.

6 Electrical characteristics

6.1 TFT-LCD Panel driving section

Ta = 25

Parameter	Symbol	Min	Typ	Max	Unit	Remarks
Supply voltage	Vcc	+3.0	+3.3	+3.6	V	[Note6-1]
Current dissipation	Icc	-	200	360	mA	[Note6-2]Vcc=3.3V
Allowed input ripple voltage	V _{RF}	-	-	100	mV p-p	
Input voltage (“Low” state)	V _{IL}	-	-	0.8	V	[Note6-3]
Input voltage (“High” state)	V _{IH}	2.1	-	-	V	
Input leakage current (low)	I _{OL1}	-10.0	-	10.0	μA	V _I =0V [Note6-4]
	I _{OL2}	-800	-	-	μA	V _I =0V [Note6-5]
	I _{OL3}	-10.0	-	10.0	μA	V _I =0V [Note6-6]
Input leakage current (High)	I _{OH1}	-10.0	-	10.0	μA	V _I =Vcc [Note6-4]
	I _{OH2}	-10.0	-	10.0	μA	V _I =Vcc [Note6-5]
	I _{OH3}	-	-	800	μA	V _I =Vcc [Note6-6]

[Note6-1] Vcc turn-on/off conditions

- 0 < t1 ≤ 15ms
- 0 < t2 ≤ 10ms
- 0 < t3 ≤ 100ms
- 0 < t4 ≤ 1s
- t5 > 200ms

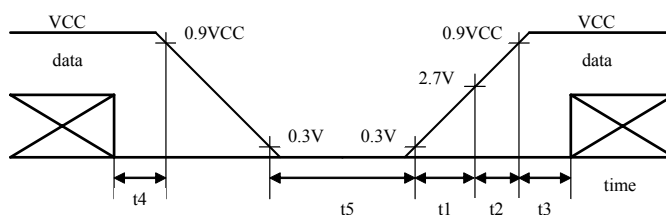

Vcc-dip conditions

- 1) At 2.5V ≤ Vcc
td ≤ 10ms
- 2) At Vcc < 2.5V
Vcc dip conditions should also follow the Vcc turn-on/off conditions

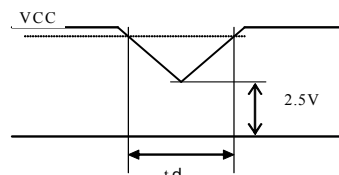

[Note6-2] Current dissipation (Typ.):

When Monochrome 16 level-gray-bar pattern is displayed
(Figure below, Refer Page 10 for details of RGB)

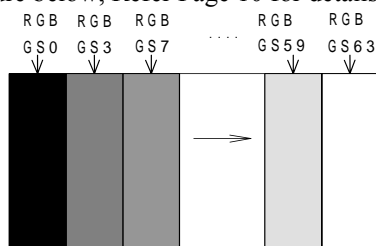

Current dissipation(Max):

When VS(V63) and V0 stripe pattern are displayed alternately at intervals of two lines. (Figure below, Refer Page 10 for details of RGB)

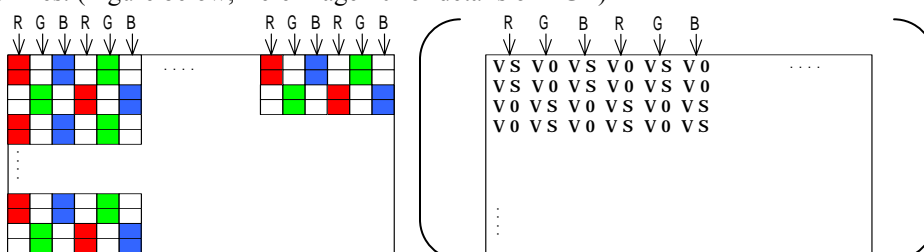

[Note6-3] CK, R0~R5, G0~G5, B0~B5, Hsync, Vsync, ENAB, R/L and U/D

[Note6-4] CK, R0~R5, G0~G5, B0~B5, Hsync, Vsync, and ENAB

[Note6-5] R/L

[Note6-6] U/D

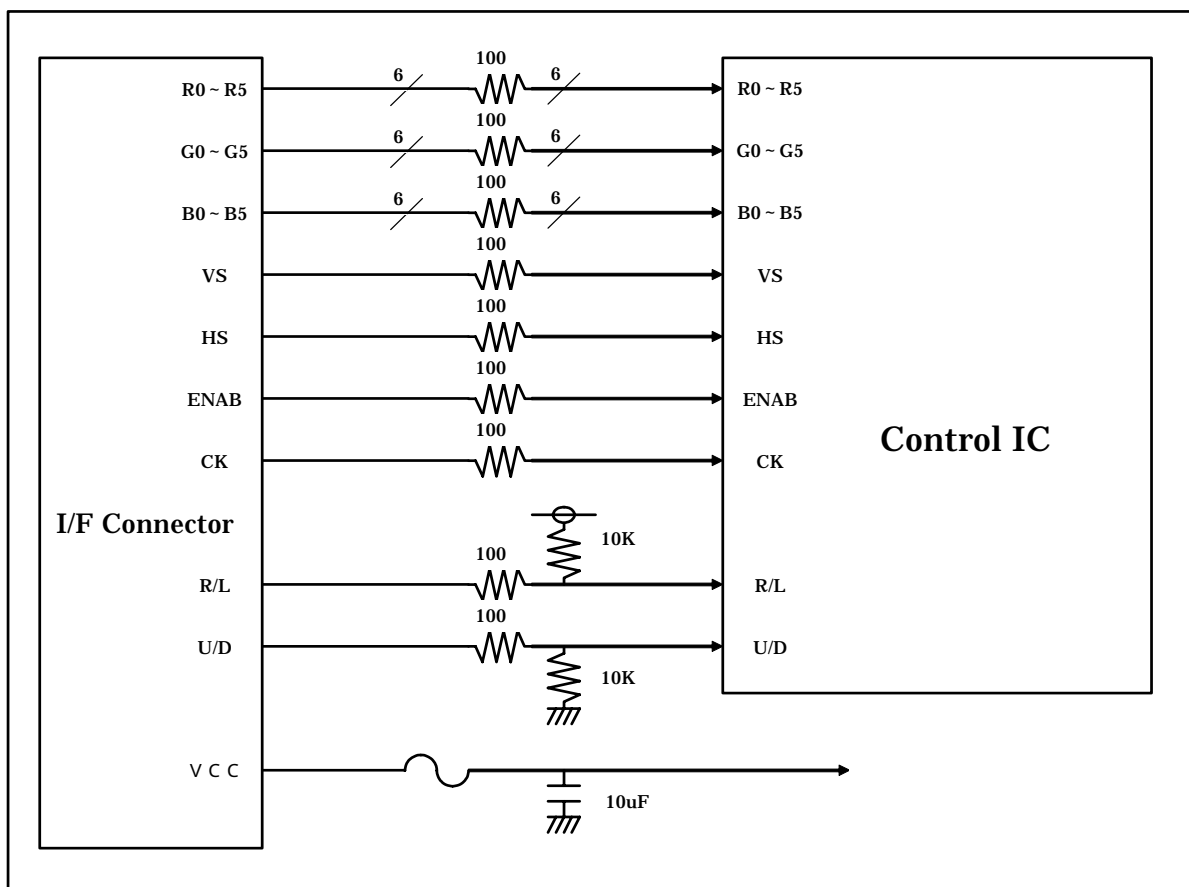

6.2 Backlight driving Section

The backlight system is an edge-lighting type with white-LED.

The characteristics of LED are shown in the following table.

(It is usually required to measure under the following condition.

condition: $I_L = 100\text{mA}$ /Constant current drive, $T_a = 25 \pm 2$)

Parameter	Symbol	Min.	Typ.	Max.	Unit	Remark
LED voltage	V_L	-	19.8	-	V	
LED current range	I_L	-	100	105	mA	Value for one channel
Number of circuit channel		-	2	-		[Note 6-7]
LED power consumption	W_L	-	3.96	-	W	[Note 6-8]
Life time (LCD module)	L_L	-	50,000	-	Hour	[Note 6-9,10]

[Note 6-7] The LED backlight is composed of 2 channels which 6 LED is connected in series.

[Note 6-8] Calculated value for reference ($I_L \times V_L \times 2$ channel)

[Note 6-9] Lighting condition:

- The state of the LCD module installation: Landscape position and standing position
- Atmosphere temperature: 25
- Lighting current: 100mA (Constant current drive / Continuous turning on)

Definition of Life time:

Brightness becomes 50% of the original value .(under condition)

[Note 6-10] In the method of the parallel connection of the input of each channel and the drive, an excessive current flows to the channel side where the voltage is low, and, as a result, there is a possibility of causing the LED longevity decrease.

It is preferable to do the fixed current drive only for each channel to each channel.

7 Timing Characteristics of Input Signals

Timing diagrams of input signal are shown in Fig.2.

7.1 Timing Characteristics

Parameter		Symbol	Min.	Typ.	Max.	Unit	Remark
Clock	Frequency	$1/T_c$	-	25.18	28.33	MHz	
	“High” time	T_{ch}	5	-	-	ns	
	“Low” time	T_{cl}	10	-	-	ns	
Data	Setup time	T_{ds}	5	-	-	ns	
	Hold time	T_{dh}	10	-	-	ns	
Hsync	Period	T_H	30.00	31.78		μs	
			750	800	900	clock	
	Pulse width	T_{Hp}	2	96	200	clock	
Vsync	Period	T_V	515	525	560	line	
	Frequency	$1/T_v$	50	60	-	Hz	[Note7-1]
	Pulse width	T_{Vp}	1	-	34	line	
Horizontal display period		T_{Hd}	640	640	640	clock	
Phase difference between Hsync and clock		T_{Hc}	10	-	$T_c - 10$	ns	
Phase difference between Hsync and Vsync		T_{Vh}	0	-	$T_H - T_{Hp}$	clock	
Vertical display period		T_{Vs}	34	34	34	line	

Note7-1) In case of lower frequency, the deterioration of display quality, flicker etc., may occur.

Please use this module in more than 50Hz.($1/T_v$)

7.2 Display Position in horizontal direction

Display position in horizontal direction is designated by rising timing of ENAB signal.

Parameter	Symbol	MIN	TYP	MAX	Unit	Note
ENAB signal	Setup time	Tes	5	-	Tc -10	ns
	Pulse width	Tep	2	640	TH-10	clock
Phase difference between Hsync and ENAB signal	THE	44	-	TH-664	clock	

When ENAB is fixed to "Low", the horizontal display will start from the clock C104 (clock) as shown in Fig.2. When the phase difference is not greater than 104 clock, hold ENAB terminal in "High" state for more than (104-THe), otherwise display will start from C104 (clock).

7.3 Display position in vertical direction

Display start position in vertical direction is fixed to the 34th line.

7.4 Input signal and display on the screen

Display position of input data

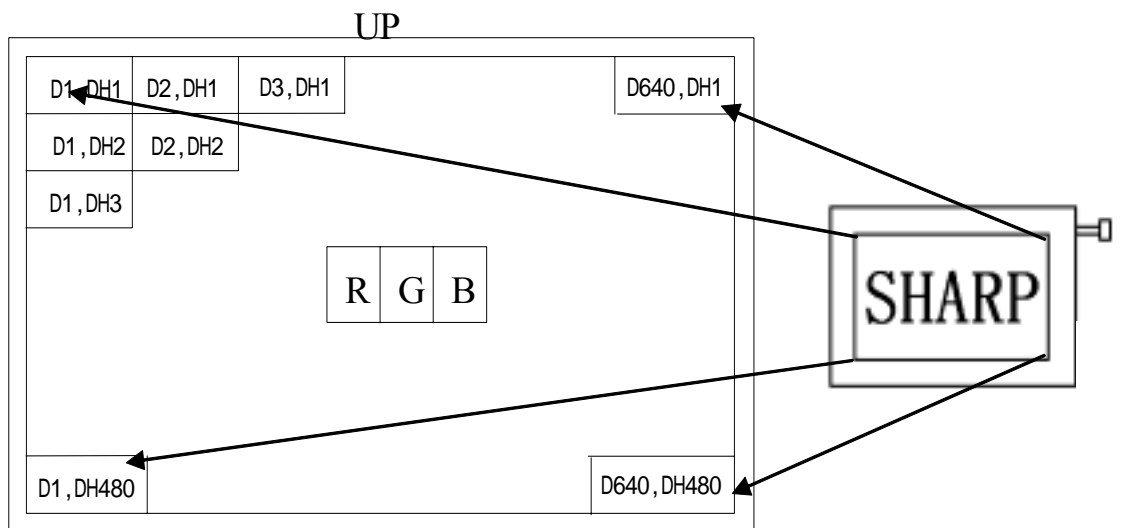

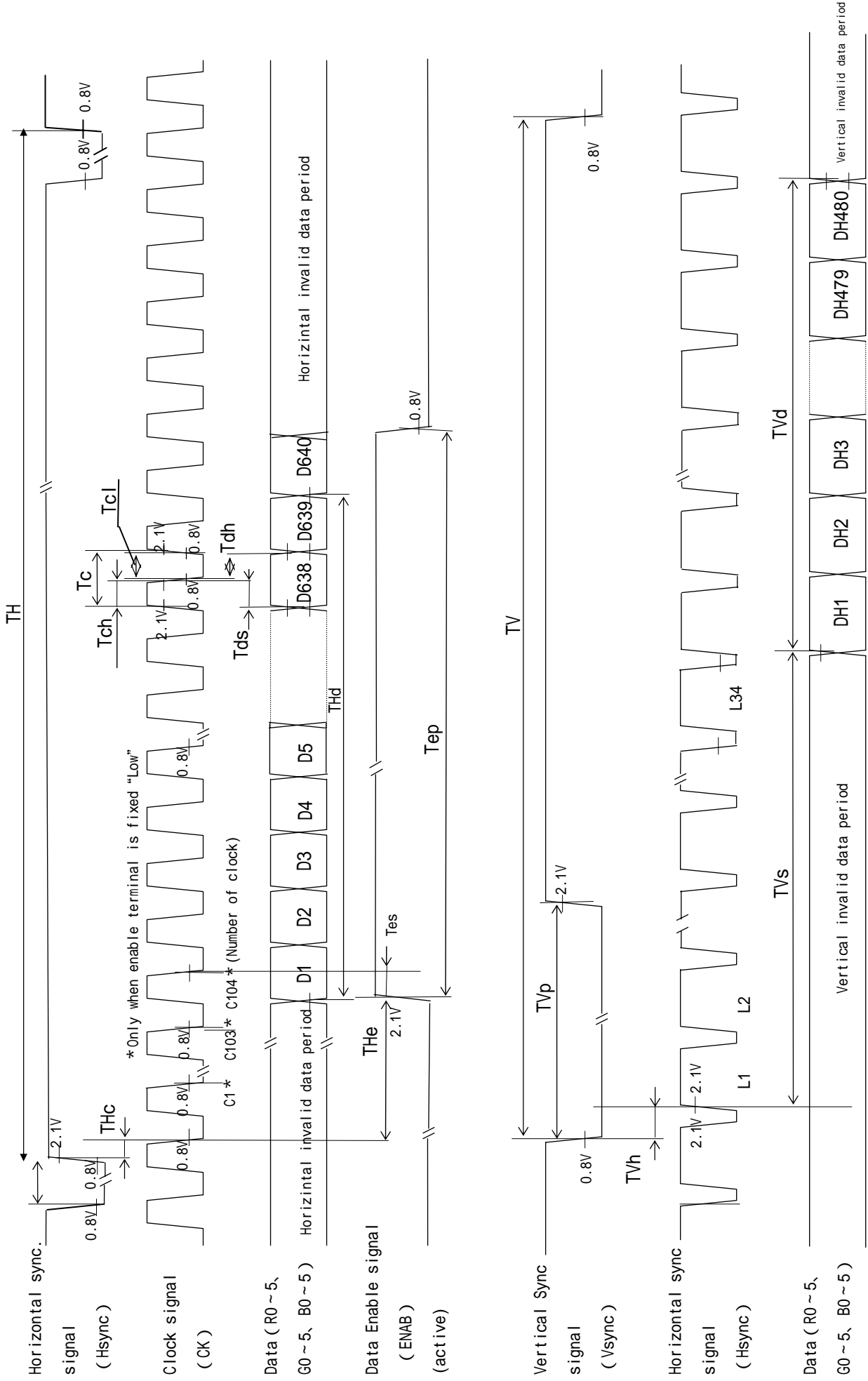

Fig. 2. Input signal waveform

8 Input Signals, Basic Display Colors and Gray Scale of Each Color

	Colors & Gray scale	Data signal																		
		Gray Scale	R0	R1	R2	R3	R4	R5	G0	G1	G2	G3	G4	G5	B0	B1	B2	B3	B4	B5
Basic Color	Black	-	0	0	0	0	0	0	0	0	0	0	0	0	0	0	0	0	0	0
	Blue	-	0	0	0	0	0	0	0	0	0	0	0	0	1	1	1	1	1	1
	Green	-	0	0	0	0	0	0	1	1	1	1	1	1	0	0	0	0	0	0
	Cyan	-	0	0	0	0	0	0	1	1	1	1	1	1	1	1	1	1	1	1
	Red	-	1	1	1	1	1	1	0	0	0	0	0	0	0	0	0	0	0	0
	Magenta	-	1	1	1	1	1	1	0	0	0	0	0	0	1	1	1	1	1	1
	Yellow	-	1	1	1	1	1	1	1	1	1	1	1	1	0	0	0	0	0	0
	White	-	1	1	1	1	1	1	1	1	1	1	1	1	1	1	1	1	1	1
Gray Scale of Red	Black	GS0	0	0	0	0	0	0	0	0	0	0	0	0	0	0	0	0	0	0
	↑	GS1	1	0	0	0	0	0	0	0	0	0	0	0	0	0	0	0	0	0
	Darker	GS2	0	1	0	0	0	0	0	0	0	0	0	0	0	0	0	0	0	0
	↑	↓				↓					↓						↓			
	↓	↓				↓					↓						↓			
	Brighter	GS61	1	0	1	1	1	1	0	0	0	0	0	0	0	0	0	0	0	0
	↓	GS62	0	1	1	1	1	1	0	0	0	0	0	0	0	0	0	0	0	0
Red	GS63	1	1	1	1	1	1	0	0	0	0	0	0	0	0	0	0	0	0	
Gray Scale of Green	Black	GS0	0	0	0	0	0	0	0	0	0	0	0	0	0	0	0	0	0	0
	↑	GS1	0	0	0	0	0	0	1	0	0	0	0	0	0	0	0	0	0	0
	Darker	GS2	0	0	0	0	0	0	0	1	0	0	0	0	0	0	0	0	0	0
	↑	↓				↓					↓						↓			
	↓	↓				↓					↓						↓			
	Brighter	GS61	0	0	0	0	0	0	1	0	1	1	1	1	0	0	0	0	0	0
	↓	GS62	0	0	0	0	0	0	0	1	1	1	1	1	0	0	0	0	0	0
Green	GS63	0	0	0	0	0	0	1	1	1	1	1	1	0	0	0	0	0	0	
Gray Scale of Blue	Black	GS0	0	0	0	0	0	0	0	0	0	0	0	0	0	0	0	0	0	0
	↑	GS1	0	0	0	0	0	0	0	0	0	0	0	0	1	0	0	0	0	0
	Darker	GS2	0	0	0	0	0	0	0	0	0	0	0	0	0	1	0	0	0	0
	↑	↓				↓					↓						↓			
	↓	↓				↓					↓						↓			
	Brighter	GS61	0	0	0	0	0	0	0	0	0	0	0	0	1	0	1	1	1	1
	↓	GS62	0	0	0	0	0	0	0	0	0	0	0	0	0	1	1	1	1	1
Blue	GS63	0	0	0	0	0	0	0	0	0	0	0	0	1	1	1	1	1	1	

0: Low level voltage, 1: High level voltage

Each basic color can be displayed in 64 gray scales from 6 bit data signals. According to the combination of total 18 bit data signals, the 262,144-color display can be achieved on the screen.

9 Optical Specification

Ta=25°C, Vcc=+3.3V

Parameter		Symbol	Condition	Min.	Typ.	Max.	Unit	Remark
Viewing angle Range	Horizontal	21, 22	CR \geq 10	50	65	-	° (Deg.)	[Note9-1,4]
	Vertical	11		40	55	-	° (Deg.)	
		12		45	60	-	° (Deg.)	
Contrast ratio		CR max	Best viewing angle	400	600	-	-	[Note9-2] Center of screen
Response time	Rise	Tr	= 0°	-	5	15	ms	[Note9-3]
	Fall	Td		-	21	40	ms	Center of screen
Chromaticity of white		x	IL=100mA	0.234	0.292	0.354	-	[Note9-4]
		y		0.261	0.316	0.383	-	
Luminance		Y			300	400	-	

The optical specifications are measured 30 minute after turning LED on and in a dark room or equivalent condition, according to the method shown in below.(Condition: I_L =100mA)

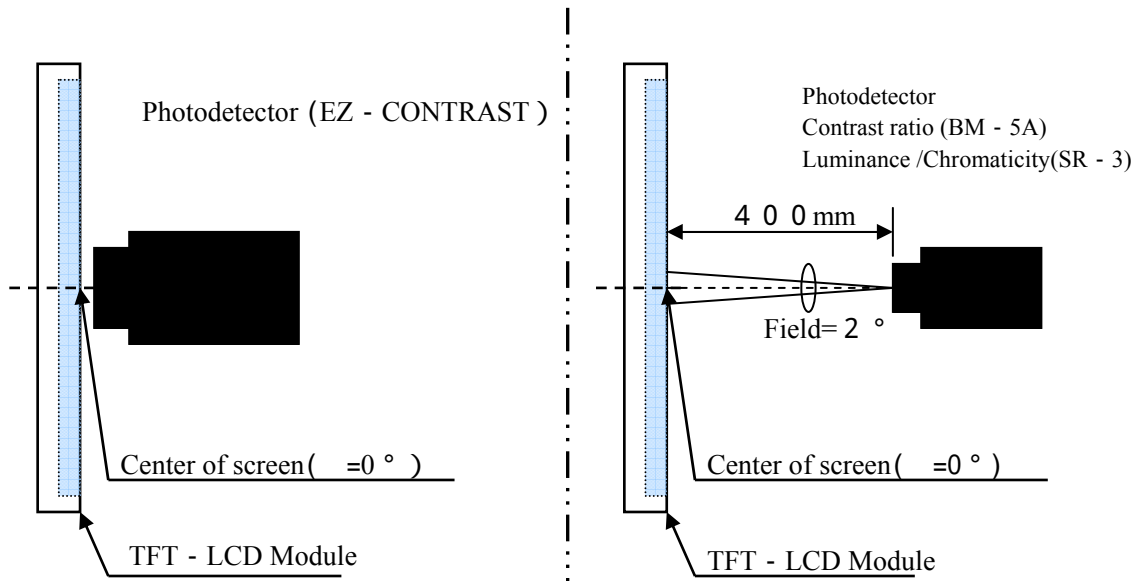
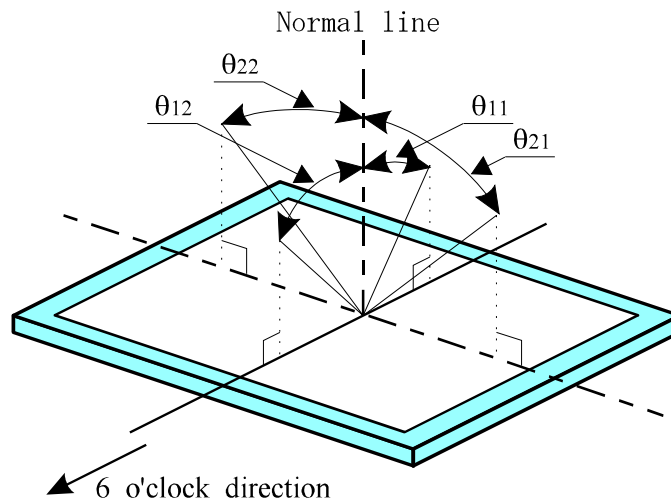

Fig3 Optical characteristics measurement method

[Note9-1] Definitions of viewing angle range:



The best viewing angle of this module is slightly leaned to 6 o'clock from normal line. In the field where θ_{12} exceeds this angle, gray-scale is reversed partially. The gray-scale in the field of 12 o'clock direction is brighter than that of 6 o'clock direction and isn't reversed.

[Note9-2] Definition of contrast ratio:

The contrast ratio is defined as the following.

$$\text{Contrast Ratio (CR)} = \frac{\text{Luminance (brightness) with all pixels white}}{\text{Luminance (brightness) with all pixels black}}$$

[Note9-3] Definition of response time:

The response time is defined as the following figure and shall be measured by switching the input signal between "black" and "white" alternatively.

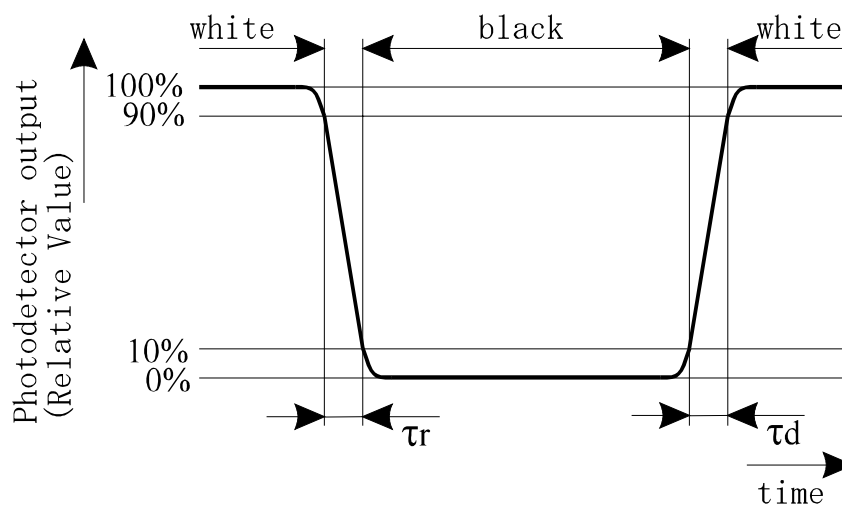

[Note9-4] This parameter should be measured at the center of the screen and 30 minutes after turn-on.

The characteristics are measured when the driver circuit is not powered.

10 Display Qualities

Please refer to the Outgoing Inspection Standard.

11 Handling Instruction

11.1 Assembling the module

- 1) Be sure to design the cabinet so that the module can be installed without any extra stress such as warp or twist.
- 2) Please power off the module before you connect or disconnect input connector.
- 3) Make sure to connect module's metal shield case to GND of DCDC converter circuit.

If its connection is not made perfectly, some of the following problems may occur.

- a) Increase of noise caused by backlight
- b) Unstable output from DCDC converter circuit
- c) Possibly over-heat in some section

11.2 Instruction for assembling

- 1) Since the front polarizer is easily damaged, pay attention to avoid rubbing with something hard or sharp.
- 2) How to eliminate dust on polarizer.
 - Blow dust away by N₂ blower having measures of electrostatics
 - Since the front polarizer is easily damaged, wiping dust off is not adequate. If the polarizer is soiled, it is suggested to peel dust off by using adhesive surface of adhesive tape.
- 3) When the metal section [shield case or shield back case] is soiled, wipe it off with dry and soft cloth. If not so easy, breathe upon it then wipe off. If the water droplet or fat is left for long term, it may cause stain or tarnish, it should be wipe off immediately.
- 4) Since TFT-LCD panel is made of glass substrate, dropping the panel or banging it against hard objects may cause cracking or fragmentation.
- 5) Since CMOS LSIs are incorporated in this module, please pay special care to electrostatic while handling it, and earth human body.

11.3 Caution in product design

- 1) The notes and cautions below should be followed when product is designed with this module.
- 2) The module should be protected with cover to prevent salt content and/or water droplet. Take enough shielding countermeasure not to interfere to peripheral electronic device.
- 3) If a minute particle enters in the module and adheres to an optical material, it may cause display non-uniformity issue, etc. Therefore, fine-pitch filters have to be installed to cooling and inhalation hole if you intend to install a fan.
- 4) The LED used for this product is very sensitive to the temperature. Luminance decreases rapidly when it is used for a long time under the environment of the high temperature. Please consult our company when it is used under the environment like the above mentioned.

11.4 Others

The LCD has the nature that its performance is degradation by ultra-violet light. Don't leave the LCD module in direct sunlight or strong ultra violet ray.

If stored at the temperatures lower than the rated storage temperature, the LC may freeze and it may cause LCD panel damage. If storage temperature exceeds the specified rating, the molecular orientation of the LC may change to that of a liquid, and they may not revert to their original state. Store the module in normal room temperature.

The liquid crystal may leak out when the LCD is broken. If the liquid crystal drip into the eyes or mouth washes it out immediately.

The caution to other ordinal electronic component should be followed also.

Avoid the LCD to use and leave in the atmosphere with condensation and/or the high concentration of corrosive gasses described below;- Sulfurous gasses (ex; SO₂(sulfur dioxide), CS₂(carbon disulfide), H₂S(hydrogen sulfide)), Cl₂(chlorine), HCl(hydrogen chloride), NH₃(ammonia) and so on.

12 Packing Form

12.1 Fig.4 shows packaging form.

12.2 Carton stock conditions

- a) Maximum number of Carton being stuck: 6
- b) Maximum number of product contained: 10 Unit
- c) Carton size: 408mm (W) x 203mm (H) x 244mm (D)
- d) Total mass (for 10Unit): 6kg (max)
- e) Carton stock environment:
 - 1) Temperature: 0 ~ 40°C
 - 2) Humidity: Up to 60%RH
 - 3) Ambiance: No gasses bite into electronic components and wiring materials
 - 4) Period: Approximately 3month
 - 5) Unpacking: To prevent LCD module from damaging by ESD, unpack the module with effective measure after controlling humidity 50%RH or more.

13 Marking of product name

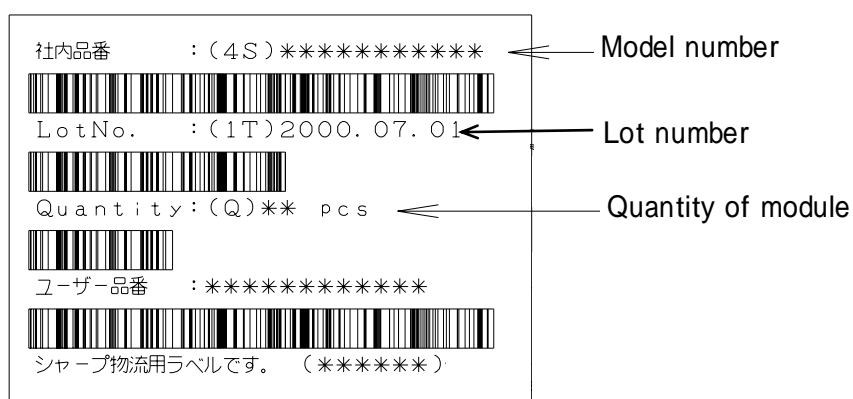

14 Miscellaneous

- a) Variable resistor has been set optimally before shipment, so do not change any adjusted value. If adjusted value is changed, the specification may be not satisfied.
- b) Don't disassemble this module, it may cause malfunction.
- c) Image retention may occur when the fixed image is display for long time.
- d) Liquid crystal panel drive input FFC/FPC specification
- The following FFC/FPC is recommended for input connector.
[IMSA-9637S-33Y902 (IRISO Electronics co.,ltd.) , 33pin 0.5mm pitch]
 - The terminal of FFC/FPC of input connector recommend to be gold or gold plated.
Because point of contact of the connection is gold plated.
- e) When any question or issue occurs, it shall be solved by mutual discussion.

15 Reliability Test Items

No.	Test parameter	Conditions
1	High temperature storage test	Leaves the module at Ta=80°C for 240h
2	Low temperature storage test	Leaves the module at Ta=-30°C for 240h
3	High temperature & high humidity operation test	Operates the module at Ta=40°C;90~95%RH for 240h (No condensation)
4	High temperature operation test	Operates the module with +80°C at panel surface for 240h
5	Low temperature operation test	Operates the module at Ta=-30°C for 240h
6	Strength against ESD	±200V · 200pF [0Ω] one time for each terminal
7	Shock test (non- operating)	Max. acceleration : 686m/s ² (70G) Pulse width : 6ms, half sine wave Direction : ±X,±Y,±Z once for each direction.
8	Vibration test (non- operating)	Frequency : 10 ~ 57Hz/Vibration width (one side):0.15mm : 57 ~ 500Hz/ acceleration:19.6m/s ² Sweep time : 11 minutes Test period : 3 hours (1 hour for each direction of X,Y,Z)
9	Thermal shock test	-30°C[0.5h] ~ +80°C[0.5h] /50 cycle

[Result Evaluation Criteria]

Under the display quality test conditions with normal operation state, these shall be no change which may affect practical display function.

[Note] The directions of X, Y, Z are defined as below:

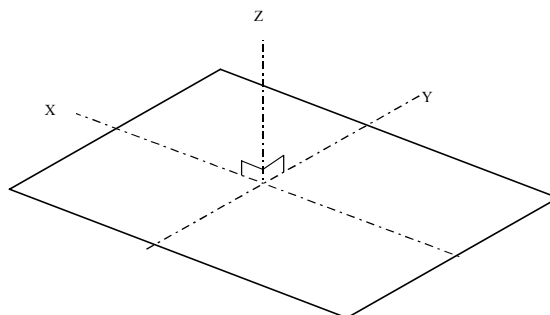

16. Storage conditions

<Environmental condition range of storage temperature and humidity>

Temperature 0 to 40 degrees Celsius

Relative humidity 95% and below

[Note] Please refer below as a mean value of the environmental conditions.

Summer time temperature 20 to 35 degrees Celsius

humidity 85% and below

Winter time temperature 5 to 15 degrees Celsius

humidity 85% and below

Please maintain within 240 hours of accumulated length of storage time, with conditions of 40 degrees Celsius and room humidity of 95%.

Direct sun light

Please keep the product in a dark room or cover the product to protect from direct sun light.

Atmospheric condition

Please refrain from keeping the product with possible corrosive gas or volatile flux.

Prevention of dew

- * Please store the product carton either on a wooden pallet or a stand / rack to prevent dew.
Do not place directly on the floor. In addition, to obtain moderate ventilation in between the pallet's top and bottom surfaces, pile the cartons up in a single direction and in order.
- * Please place the product cartons away from the storage wall.
- * Please maintain the storage area with an appropriate ventilation. It is recommendable to furnish the storage area with equipments such as ventilation systems.
- * Please maintain the ambient temperature within the range of natural environmental fluctuation.

Storage period

Within above mentioned conditions, maximum storage period should be one year.

SHARP

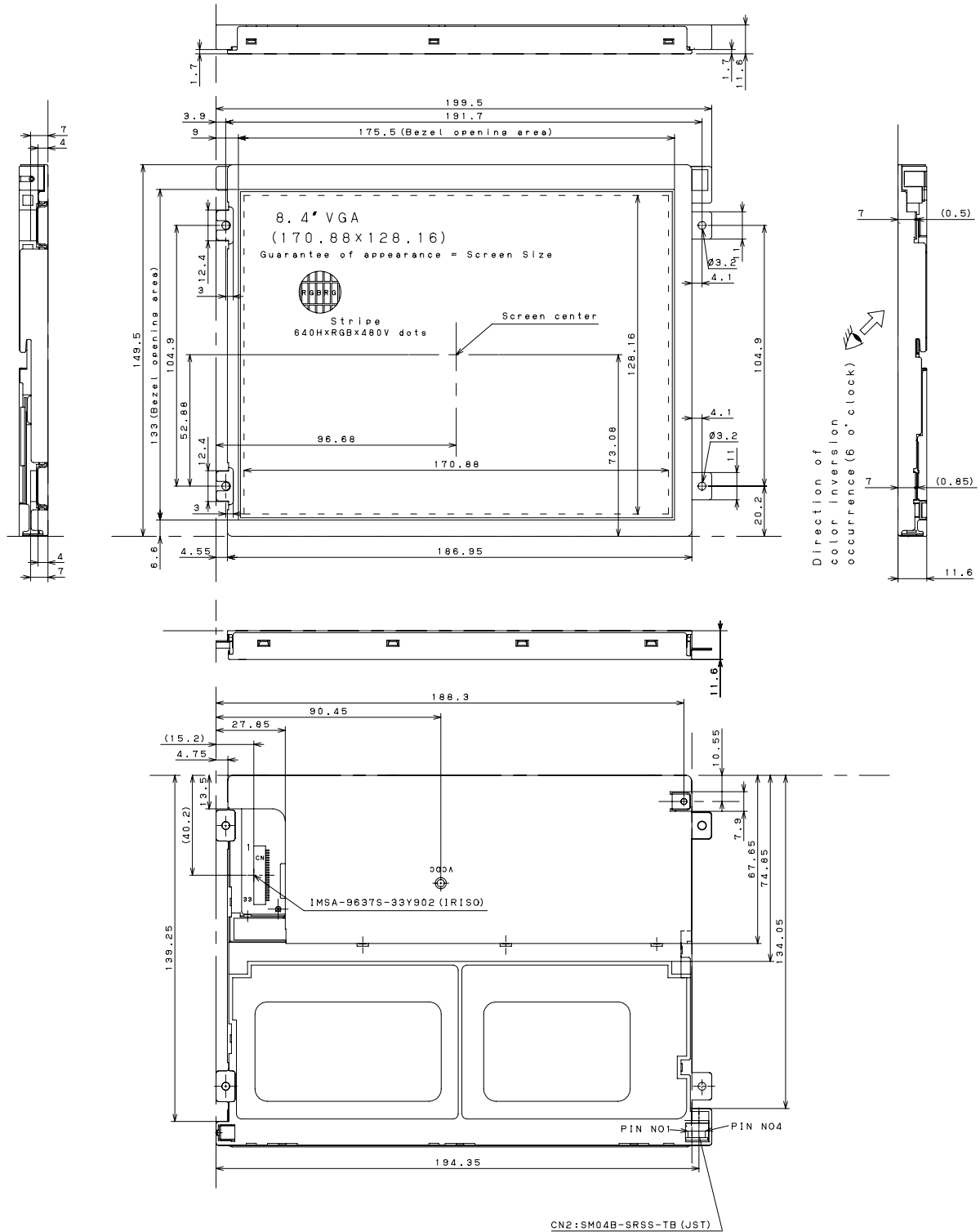

General tolerance is ± 0.5 .

Take care in set design to hide the scratches and bubbles appeared on the polarizer or other frame area which is located outside of active area.

unit:mm	Please do not copy this material and do not disclose this to third party.		▲		
DATE	2008.7.10	SCALE	▲		
MODEL	LIQ01841V3DIG02	free	▲	No.	DATE REVISION
DRAWING NO	size A2		▲	ENGINEERING DEPARTMENT MOBILE LCD DIVISION MOBILE LIQUID CRYSTAL DISPLAY GROUP SHARP CORPORATION	

FIG.1 OUTLINE DIMENSIONS

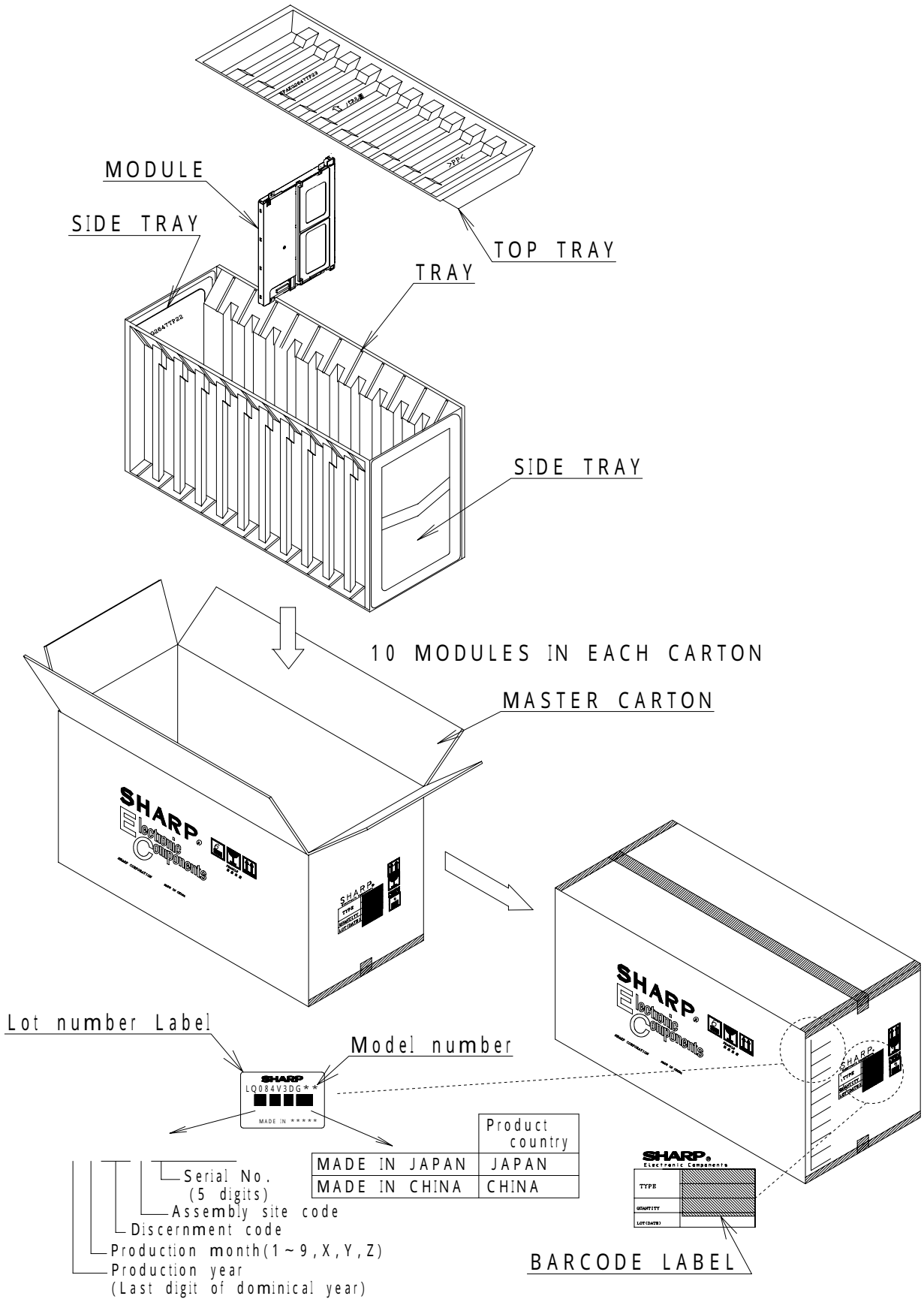

FIG. 4 PACKING FORM