

X2 CLASS (IEC 60384-14) - MKP Series METALLIZED POLYPROPYLENE FILM CAPACITOR SELF-HEALING PROPERTIES

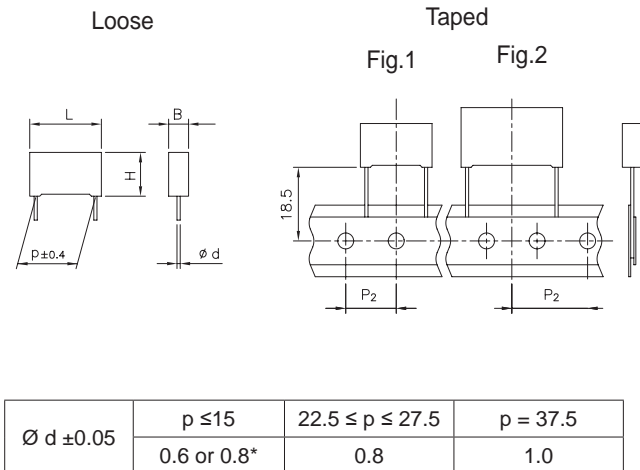

*See size table.

All dimensions are in mm.

GENERAL TECHNICAL DATA

Dielectric: polypropylene film - 2 sections.

Plates: metal layer deposited by evaporation under vacuum.

Winding: non-inductive type.

Leads: tinned wire.

Protection: plastic case, thermosetting resin filled.

Box material is solvent resistant and flame retardant according to UL94 V0.

Marking: Manufacturer's logo, series, capacitance, tolerance, rated voltage, capacitor class, dielectric code, climatic category, passive flammability category, manufacturing date code, approvals, manufacturing plant.

Climatic category: 40/110/56 IEC 60068-1

Operating temperature range: -40 to +110°C

Related documents: IEC 60384-14; EN 60384-14.

ELECTRICAL CHARACTERISTICS

Rated voltage (V_R): 440Vac / 1000Vdc; 50/60Hz

Capacitance range: 4700pF to 2.2µF

Capacitance values: E6 series (IEC 60063 Norm).

Capacitance tolerances (measured at 1 kHz):
±10% (K); ±20% (M).
Tolerance ±5% (J) available upon request.

Dissipation factor (DF):

$\text{tg} \delta \times 10^{-4}$ at +25°C ±5°C: ≤10 (6)* at 1kHz *
Typical value

Insulation resistance:

Test conditions

Temperature: +25°C ±5°C

Voltage charge time: 1 min

Voltage charge: 100 Vdc

Performance

≥1×10⁵ MΩ for C≤0.33µF

≥30000 s for C>0.33µF

Test voltage between terminations (on all pieces):

1700Vac for 1 s + 2700Vdc for 1 s at +25°C ±5°C

Typical applications: interference suppression and «across-the-line» applications. Suitable for use in situations where failure of the capacitor would not lead to danger of electric shock.

PRODUCT CODE: R47

Pitch (mm)	Box thickness (B) (mm)	Maximum dimensions (mm)		
		B max	H max	L max
10.0	All	B +0.2	H +0.1	L +0.2
15.0	<7.5	B +0.2	H +0.1	L +0.3
15.0	≥7.5	B +0.2	H +0.1	L +0.5
22.5	All	B +0.2	H +0.1	L +0.3
27.5	All	B +0.2	H +0.1	L +0.3
37.5	All	B +0.3	H +0.1	L +0.3

TEST METHOD AND PERFORMANCE

Damp heat, steady state:

Test conditions 1st

Temperature: +40°C ± 2°C

Relative humidity (RH): 93% ±2%

Test duration: 56 days

Test conditions 2nd

Temperature: +60°C ± 2°C

Relative humidity (RH): 95% ±2%

Test duration: 500 hours

Performance

Dielectric strength: no dielectric breakdown or flashover at 4.3 x V_R (d.c.)/1 min

Capacitance change $|\Delta C/C|$: ≤5%

Insulation resistance: ≥50% of initial limit.

Endurance:

Test conditions

Temperature: +110°C ± 2°C

Test duration: 1000 h

Voltage applied: 1.25 x V_R +1000Vac 0.1 s/h

Performance

Dielectric strength: no dielectric breakdown or flashover at 4.3 x V_R (d.c.)/1 min

Capacitance change $|\Delta C/C|$: ≤10%

Insulation resistance: ≥50% of initial limit.

Resistance to soldering heat:

Test conditions

Solder bath temperature: +260°C ± 5°C

Dipping time (with heat screen): 10 s ± 1 s

Performance

Capacitance change $|\Delta C/C|$: ≤2%

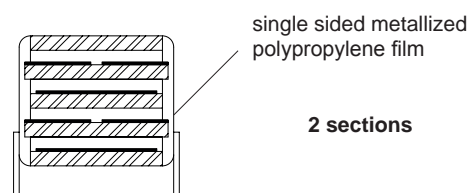

Winding scheme



X2 CLASS (IEC60384-14) - MKP Series METALLIZED POLYPROPYLENE FILM CAPACITOR SELF-HEALING PROPERTIES

PRODUCT CODE: R47

APPROVALS

 (*)	ENEC IEC 60384-14	Class X2	File No. CA08.00101
	UL 1414 up to 1µF, 85°C; 250Vac)	Across-the-line	File No. E97797
	UL 1283	Electromagnetic Interference Filters	File No. E85238

Approved according to IEC 60384-14
According to IEC 60065.

(*) ENEC mark has replaced all the following European
National marks:



Rated Cap.	440 Vac / 1000 Vdc Std dimensions				Ø d	Max dv/dt at 420Vdc (V/µs)	Part Number	
	B	H	L	p				
4700 pF	4.0	9.0	13.0	10.0	0.6	750	R474F	1470 -- 01 -
6800 pF	5.0	11.0	13.0	10.0	0.6	750	R474F	1680 -- 01 -
8200 pF	6.0	12.0	13.0	10.0	0.6	750	R474F	1820 -- 01 -
0.010 µF	6.0	12.0	13.0	10.0	0.6	750	R474F	2100 -- 01 -
0.010 µF	5.0	11.0	18.0	15.0	0.6	600	R474I	2100 -- 01 -
0.012 µF	5.0	11.0	18.0	15.0	0.6	600	R474I	2120 -- 01 -
0.015 µF	5.0	11.0	18.0	15.0	0.6	600	R474I	2150 -- 01 -
0.018 µF	5.0	11.0	18.0	15.0	0.6	600	R474I	2180 -- 01 -
0.022 µF	6.0	12.0	18.0	15.0	0.6	600	R474I	2220 -- 01 -
0.027 µF	6.0	12.0	18.0	15.0	0.6	600	R474I	2270 -- 01 -
0.033 µF	6.0	12.0	18.0	15.0	0.6	600	R474I	2330 -- 01 -
0.039 µF	7.5	13.5	18.0	15.0	0.6	600	R474I	2390 -- 01 -
0.047 µF	7.5	13.5	18.0	15.0	0.6	600	R474I	2470 -- 01 -
0.047 µF	6.0	17.5	18.0	15.0	0.6	600	R474I	2470 -- 02 -
0.047 µF	9.0	12.5	18.0	15.0	0.6	600	R474I	2470 -- 03 -
0.056 µF	8.5	14.5	18.0	15.0	0.6	600	R474I	2560 -- 01 -
0.068 µF	10.0	16.0	18.0	15.0	0.8	600	R474I	2680 -- 01 -
0.068 µF	7.5	18.5	18.0	15.0	0.8	600	R474I	2680 -- 02 -
0.068 µF	13.0	12.0	18.0	15.0	0.8	600	R474I	2680 -- 03 -
0.082 µF	10.0	16.0	18.0	15.0	0.8	600	R474I	2820 -- 01 -
0.10 µF	11.0	19.0	18.0	15.0	0.8	600	R474I	3100 -- 01 -
0.047 µF	6.0	15.0	26.5	22.5	0.8	300	R474N	2470 -- 01 -
0.047 µF	6.5	13.5	26.5	22.5	0.8	300	R474N	2470 -- 02 -
0.068 µF	6.0	15.0	26.5	22.5	0.8	300	R474N	2680 -- 01 -
0.10 µF	7.0	16.0	26.5	22.5	0.8	300	R474N	3100 -- 01 -
0.12 µF	8.5	17.0	26.5	22.5	0.8	300	R474N	3120 -- 01 -
0.15 µF	10.0	18.5	26.5	22.5	0.8	300	R474N	3150 -- 01 -
0.18 µF	10.0	18.5	26.5	22.5	0.8	300	R474N	3180 -- 01 -
0.22 µF	11.0	20.0	26.5	22.5	0.8	300	R474N	3220 -- 01 -
0.27 µF	13.0	22.0	26.5	22.5	0.8	300	R474N	3270 -- 01 -
0.33 µF	13.0	22.0	26.5	22.5	0.8	300	R474N	3330 -- 01 -
0.15 µF	9.0	17.0	32.0	27.5	0.8	225	R474R	3150 -- 01 -
0.18 µF	9.0	17.0	32.0	27.5	0.8	225	R474R	3180 -- 01 -
0.22 µF	9.0	17.0	32.0	27.5	0.8	225	R474R	3220 -- 01 -
0.27 µF	9.0	17.0	32.0	27.5	0.8	225	R474R	3270 -- 02 -
0.33 µF	11.0	20.0	32.0	27.5	0.8	225	R474R	3330 -- 02 -
0.39 µF	11.0	20.0	32.0	27.5	0.8	225	R474R	3390 -- 01 -
0.47 µF	13.0	22.0	32.0	27.5	0.8	225	R474R	3470 -- 01 -
0.56 µF	13.0	22.0	32.0	27.5	0.8	225	R474R	3560 -- 01 -
0.68 µF	14.0	28.0	32.0	27.5	0.8	225	R474R	3680 -- 01 -
0.82 µF	18.0	33.0	32.0	27.5	0.8	225	R474R	3820 -- 01 -
1.0 µF	18.0	33.0	32.0	27.5	0.8	225	R474R	4100 -- 01 -
1.2 µF	18.0	33.0	32.0	27.5	0.8	225	R474R	4120 -- 01 -
1.5 µF	22.0	37.0	32.0	27.5	0.8	225	R474R	4150 -- 01 -
0.47 µF	11.0	22.0	41.5	37.5	1.0	150	R474W	3470 -- 01 -
0.56 µF	11.0	22.0	41.5	37.5	1.0	150	R474W	3560 -- 01 -
0.68 µF	13.0	24.0	41.5	37.5	1.0	150	R474W	3680 -- 01 -
0.82 µF	16.0	28.5	41.5	37.5	1.0	150	R474W	3820 -- 01 -
1.0 µF	16.0	28.5	41.5	37.5	1.0	150	R474W	4100 -- 01 -
1.2 µF	19.0	32.0	41.5	37.5	1.0	150	R474W	4120 -- 01 -
1.5 µF	19.0	32.0	41.5	37.5	1.0	150	R474W	4150 -- 01 -
1.8 µF	20.0	40.0	41.5	37.5	1.0	150	R474W	4180 -- 01 -
2.2 µF	20.0	40.0	41.5	37.5	1.0	150	R474W	4220 -- 01 -

Table 1

Standard packaging style	Lead length (mm)	Taping style			Ordering code (Digit 10 to 11)
		P ₂ (mm)	Fig. (No.)	Pitch (mm)	
AMMO-PACK		12.70	1	10.0/15.0	DQ
AMMO-PACK		19.05	2	22.5	DQ
REEL Ø500mm		12.70	1	10.0/15.0	CK
REEL Ø500mm		19.05	2	22.5/27.5	CK
Loose, short leads	4 ⁺²				00
Loose, long leads	25 ^{-1/+2}				50
Loose, long leads	30 ⁺⁵				40

Note: Ammo-pack is the preferred packaging for taped version.

Mechanical version and packaging (Table 1)
Tolerance: K (±10%); M (±20%)

All dimensions are in mm

X1 CLASS (IEC 60384-14) - MKP Series METALLIZED POLYPROPYLENE FILM CAPACITOR SELF-HEALING PROPERTIES

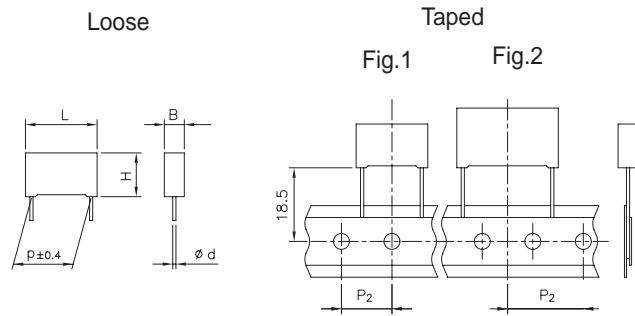

Ø d ±0.05	p ≤ 15	22.5 ≤ p ≤ 27.5	p = 37.5
	0.6 or 0.8*	0.8	1.0

*See size table.

All dimensions are in mm.

GENERAL TECHNICAL DATA

Dielectric: polypropylene film - 2 sections.

Plates: metal layer deposited by evaporation under vacuum.

Winding: non-inductive type.

Leads: tinned wire.

Protection: plastic case, thermosetting resin filled.

Box material is solvent resistant and flame retardant according to UL94 V0.

Marking: Manufacturer's logo, series, capacitance, tolerance, rated voltage, capacitor class, dielectric code, climatic category, passive flammability category, manufacturing date code, approvals, manufacturing plant.

Climatic category: 40/110/56 IEC 60068-1

Operating temperature range: -40 to +110°C

Related documents: IEC 60384-14; EN60384-14

ELECTRICAL CHARACTERISTICS

Rated voltage (V_R): 440Vac / 1000Vdc; 50/60Hz

Capacitance range: 4700pF to 2.2µF

Capacitance values: E6 series (IEC 60063 Norm).

Capacitance tolerances (measured at 1 kHz):
±10% (K); ±20% (M);
Tolerance ±5% (J) available upon request.

Dissipation factor (DF):

tgδ x 10⁻⁴ at +25°C ±5°C: ≤10 (6)* at 1kHz *
Typical value

Insulation resistance:

Test conditions

Temperature: +25°C±5°C

Voltage charge time: 1 min

Voltage charge: 100 Vdc

Performance

≥1x10⁵ MΩ for C≤0.33µF

≥30000 s for C>0.33µF

Test voltage between terminations (on all pieces):

1700Vac for 1 s + 2700Vdc for 1 s at +25°C±5°C

Typical applications: interference suppression and «across-the-line» applications. Suitable for use in situations where failure of the capacitor would not lead to danger of electric shock.

Class X1 shall be applied for PERMANENTLY CONNECTED APPARATUS.

Note: **PERMANENTLY CONNECTED APPARATUS:**

apparatus which is intended for connection to the mains by a connection which cannot be loosened **BY HAND.**

BY HAND:

operation that does not require the use of any object such a tool, coin, etc.

PRODUCT CODE: R47

Pitch (mm)	Box thickness (B) (mm)	Maximum dimensions (mm)		
		B max	H max	L max
10.0	All	B +0.2	H +0.1	L +0.2
15.0	<7.5	B +0.2	H +0.1	L +0.3
15.0	≥7.5	B +0.2	H +0.1	L +0.5
22.5	All	B +0.2	H +0.1	L +0.3
27.5	All	B +0.2	H +0.1	L +0.3
37.5	All	B +0.3	H +0.1	L +0.3

TEST METHOD AND PERFORMANCE

Damp heat, steady state:

Test conditions 1st

Temperature: +40°C ± 2°C

Relative humidity (RH): 93% ±2%

Test duration: 56 days

Test conditions 2nd

Temperature: +60°C ± 2°C

Relative humidity (RH): 95% ±2%

Test duration: 500 hours

Performance

Dielectric strength: no dielectric breakdown or flashover at 4.3 x V_R (d.c.)/1 min

Capacitance change |ΔC/C|: ≤5%

Insulation resistance: ≥50% of initial limit.

Endurance:

Test conditions

Temperature: +110°C ± 2°C

Test duration: 1000 h

Voltage applied: 1.25 x V_R + 1000Vac 0.1 s/h

Performance

Dielectric strength: no dielectric breakdown or flashover at 4.3 x V_R (d.c.)/1 min

Capacitance change |ΔC/C|: ≤10%

Insulation resistance: ≥50% of initial limit.

Resistance to soldering heat:

Test conditions

Solder bath temperature: +260°C ± 5°C

Dipping time (with heat screen): 10 s ± 1 s

Performance



Capacitance change |ΔC/C|: ≤2%

X1 CLASS (IEC 60384-14) - MKP Series METALLIZED POLYPROPYLENE FILM CAPACITOR SELF-HEALING PROPERTIES

PRODUCT CODE: R47

APPROVALS

Rated Cap.	440 Vac / 1000 Vdc Std dimensions				Ø d	Max dv/dt at 420Vdc (V/µs)	Part Number	
	B	H	L	p				
4700 pF	4.0	9.0	13.0	10.0	0.6	750	R474F	1470 -- A1 -
6800 pF	5.0	11.0	13.0	10.0	0.6	750	R474F	1680 -- A1 -
8200 pF	6.0	12.0	13.0	10.0	0.6	750	R474F	1820 -- A1 -
0.010 µF	6.0	12.0	13.0	10.0	0.6	750	R474F	2100 -- A1 -
0.010 µF	5.0	11.0	18.0	15.0	0.6	600	R474I	2100 -- A1 -
0.012 µF	5.0	11.0	18.0	15.0	0.6	600	R474I	2120 -- A1 -
0.015 µF	5.0	11.0	18.0	15.0	0.6	600	R474I	2150 -- A1 -
0.018 µF	5.0	11.0	18.0	15.0	0.6	600	R474I	2180 -- A1 -
0.022 µF	6.0	12.0	18.0	15.0	0.6	600	R474I	2220 -- A1 -
0.027 µF	6.0	12.0	18.0	15.0	0.6	600	R474I	2270 -- A1 -
0.033 µF	6.0	12.0	18.0	15.0	0.6	600	R474I	2330 -- A1 -
0.039 µF	7.5	13.5	18.0	15.0	0.6	600	R474I	2390 -- A1 -
0.047 µF	7.5	13.5	18.0	15.0	0.6	600	R474I	2470 -- A1 -
0.047 µF	6.0	17.5	18.0	15.0	0.6	600	R474I	2470 -- A2 -
0.047 µF	9.0	12.5	18.0	15.0	0.6	600	R474I	2470 -- A3 -
0.056 µF	8.5	14.5	18.0	15.0	0.6	600	R474I	2560 -- A1 -
0.068 µF	10.0	16.0	18.0	15.0	0.8	600	R474I	2680 -- A1 -
0.068 µF	7.5	18.5	18.0	15.0	0.8	600	R474I	2680 -- A2 -
0.068 µF	13.0	12.0	18.0	15.0	0.8	600	R474I	2680 -- A3 -
0.082 µF	10.0	16.0	18.0	15.0	0.8	600	R474I	2820 -- A1 -
0.10 µF	11.0	19.0	18.0	15.0	0.8	600	R474I	3100 -- A1 -
0.047 µF	6.0	15.0	26.5	22.5	0.8	300	R474N	2470 -- A1 -
0.047 µF	6.5	13.5	26.5	22.5	0.8	300	R474N	2470 -- A2 -
0.068 µF	6.0	15.0	26.5	22.5	0.8	300	R474N	2680 -- A1 -
0.10 µF	7.0	16.0	26.5	22.5	0.8	300	R474N	3100 -- A1 -
0.12 µF	8.5	17.0	26.5	22.5	0.8	300	R474N	3120 -- A1 -
0.15 µF	10.0	18.5	26.5	22.5	0.8	300	R474N	3150 -- A1 -
0.18 µF	10.0	18.5	26.5	22.5	0.8	300	R474N	3180 -- A1 -
0.22 µF	11.0	20.0	26.5	22.5	0.8	300	R474N	3220 -- A1 -
0.27 µF	13.0	22.0	26.5	22.5	0.8	300	R474N	3270 -- A1 -
0.33 µF	13.0	22.0	26.5	22.5	0.8	300	R474N	3330 -- A1 -
0.15 µF	9.0	17.0	32.0	27.5	0.8	225	R474R	3150 -- A1 -
0.18 µF	9.0	17.0	32.0	27.5	0.8	225	R474R	3180 -- A1 -
0.22 µF	9.0	17.0	32.0	27.5	0.8	225	R474R	3220 -- A1 -
0.27 µF	9.0	17.0	32.0	27.5	0.8	225	R474R	3270 -- A2 -
0.33 µF	11.0	20.0	32.0	27.5	0.8	225	R474R	3330 -- A2 -
0.39 µF	11.0	20.0	32.0	27.5	0.8	225	R474R	3390 -- A1 -
0.47 µF	13.0	22.0	32.0	27.5	0.8	225	R474R	3470 -- A1 -
0.56 µF	13.0	22.0	32.0	27.5	0.8	225	R474R	3560 -- A1 -
0.68 µF	14.0	28.0	32.0	27.5	0.8	225	R474R	3680 -- A1 -
0.82 µF	18.0	33.0	32.0	27.5	0.8	225	R474R	3820 -- A1 -
1.0 µF	18.0	33.0	32.0	27.5	0.8	225	R474R	4100 -- A1 -
1.2 µF	18.0	33.0	32.0	27.5	0.8	225	R474R	4120 -- A1 -
1.5 µF	22.0	37.0	32.0	27.5	0.8	225	R474R	4150 -- A1 -
0.47 µF	11.0	22.0	41.5	37.5	1.0	150	R474W	3470 -- A1 -
0.56 µF	11.0	22.0	41.5	37.5	1.0	150	R474W	3560 -- A1 -
0.68 µF	13.0	24.0	41.5	37.5	1.0	150	R474W	3680 -- A1 -
0.82 µF	16.0	28.5	41.5	37.5	1.0	150	R474W	3820 -- A1 -
1.0 µF	16.0	28.5	41.5	37.5	1.0	150	R474W	4100 -- A1 -
1.2 µF	19.0	32.0	41.5	37.5	1.0	150	R474W	4120 -- A1 -
1.5 µF	19.0	32.0	41.5	37.5	1.0	150	R474W	4150 -- A1 -
1.8 µF	20.0	40.0	41.5	37.5	1.0	150	R474W	4180 -- A1 -
2.2 µF	20.0	40.0	41.5	37.5	1.0	150	R474W	4220 -- A1 -

	ENEC IEC 60384-14	Class X1	File No. CA08.00101
	UL 1414 up to 1µF, 85°C; 250Vac	Across-the-line	File No. E97797
	UL 1283	Electromagnetic Interference Filters	File No. E85238

Approved according to IEC 60384-14
According to IEC 60065.

(*) ENEC mark has replaced all the following European
National marks:

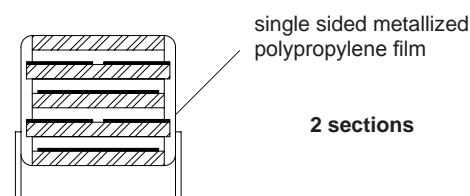

Table 1

Standard packaging style	Lead length (mm)	Taping style			Ordering code (Digit 10 to 11)
		P ₂ (mm)	Fig. (No.)	Pitch (mm)	
AMMO-PACK		12.70	1	10.0/15.0	DQ
AMMO-PACK		19.05	2	22.5	DQ
REEL Ø500mm		12.70	1	10.0/15.0	CK
REEL Ø500mm		19.05	2	22.5/27.5	CK
Loose, short leads	4 ⁺²				00
Loose, long leads	25 ^{-1/+2}				50
Loose, long leads	30 ⁺⁵				40

Note: Ammo-pack is the preferred packaging for taped version.

Winding scheme



Mechanical version and packaging (Table 1)
Tolerance: K (±10%); M (±20%)

All dimensions are in mm

Statements of suitability for certain applications are based on our knowledge of typical operating conditions for such applications, but are not intended to constitute – and we specifically disclaim – any warranty concerning suitability for a specific customer application or use. This Information is intended for use only by customers who have the requisite experience and capability to determine the correct products for their application. Any technical advice inferred from this Information or otherwise provided by us with reference to the use of our products is given gratis, and we assume no obligation or liability for the advice given or results obtained.