

Thermal Cutoffs (TCO)/ Thermal-links

- EYP** Series: **N**
 Series: **F**
 Series: **E**
 Series: **H**
 Series: **MP**
 Series: **MU**

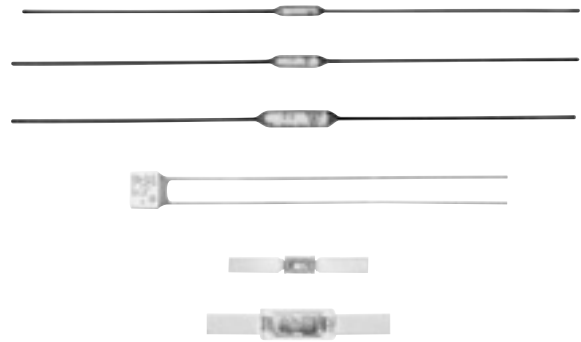

■ Features

- **Small and Insulation Type**
TCO is compact and insulated, featuring quick temperature response, and mountable in a small space without insulation or protection.
- **High Reliability**
TCO opens reliably when the equipment becomes abnormal, and is not resettable.
- **Solid Structure**
Unique formed lead provides reliable TCO connection and provides easy assembly handling. (Axial lead type only)
- **Thin Type**
Thick is less than 0.8 mm (MP series), available for spot welding (MP and MU series)
- **Halogen-free (Thin type MP and MU series)**
The thin type fuses with a part number listed in this catalog contain no halogen other than any that may exist as an impurity.
- RoHS compliant

■ Approved Safety Standards

- (Japan) : Approved by JET
 - UL, C-UL (U.S.A.) : E60271
 - CSA (Canada) : 1□□□□□□□ (LR67163)
 - VDE (Germany) : 481106-1171-□□□□
 - BEAB (U.K.) : C□□□□
 - CCC (China) : 20020102050042□□
- See Ratings in details.

■ Recommended Applications

- Transformers, Solenoids, Ventilation fans, Electric fans, Small electric motors, Driers, Gas home appliances, Fluorescent lights, Electric shavers, Adaptors, Heating devices, ICs, Batteries, etc. The TCO can also be used for overheating protection.

■ Construction

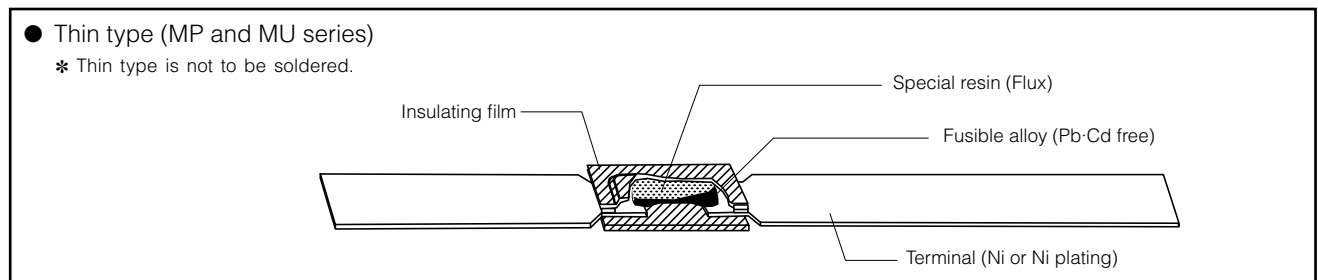
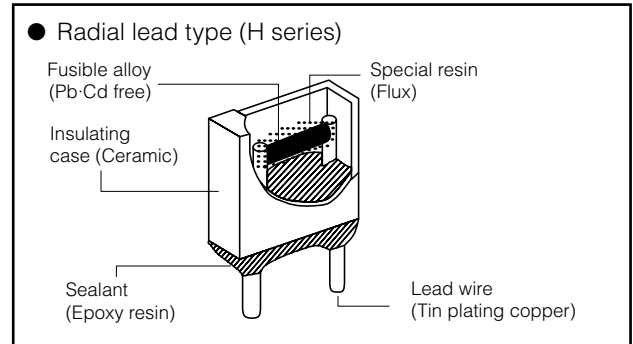
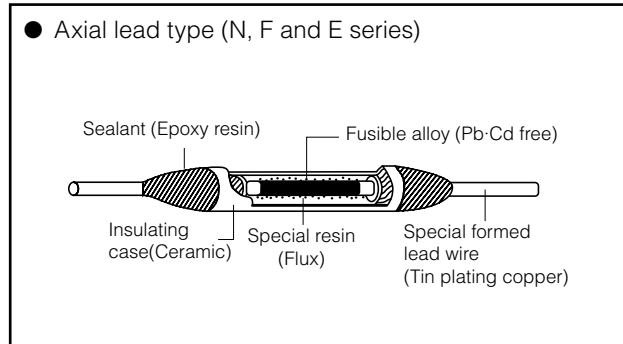

Design and specifications are each subject to change without notice. Ask factory for the current technical specifications before purchase and/or use. Should a safety concern arise regarding this product, please be sure to contact us immediately.

■ Ratings

● N series

Part No.	Type No. of Approved Standards	Rated Functioning Temp. : T _F *1 (°C)	Functioning Temp. *2 (°C)	Electrical Rating			Maximum Operating Temp. *3 (°C)	Holding Temp. : T _h *4 (°C)	Maximum Temp. Limit : T _m *5 (°C)	Approved Safety Standards						
				AC/DC	Volt. (V)	Amp. (A)					UL	CSA	VDE	BEAB	CCC	
EYP2BN082	N082	86	82±2	AC	250	2	60	60	200		○	○	○	○	○	○
				AC	125	3	52	56		—	○	○	○	○	—	
				DC	50	4	45	50		—	○	○	○	○	—	
EYP2BN099	N099	102	98 ⁺⁴ / ₋₃	AC	250	2	65	75	200		○	○	○	○	○	○
				AC	125	3	60	70		—	○	○	○	○	—	
				DC	50	4	55	65		—	○	○	○	○	—	
EYP2BN109	N109	114	110±3	AC	250	2	80	90	200		○	○	○	○	○	○
				AC	125	3	76	86		—	○	○	○	○	—	
				DC	50	5	65	74		—	○	○	○	○	—	
EYP2BN110	N110	115	110 ⁺³ / ₋₂	AC	250	2	80	90	200		○	○	○	○	○	○
				AC	125	3	76	86		—	○	○	○	○	—	
				DC	50	5	65	74		—	○	○	○	○	—	
EYP2BN127	N127	134	129±4	AC	250	2	90	100	200		○	○	○	○	○	○
				AC	125	3	75	90		—	○	○	○	○	—	
				DC	50	4	65	80		—	○	○	○	○	—	
EYP2BN134	N134	139	135±3	AC	250	2	100	110	200		○	○	○	○	○	○
				AC	125	3	85	100		—	○	○	○	○	—	
				DC	50	6	60	70		—	○	○	○	○	—	
EYP2BN143	N143	145	141±2	AC	250	2	110	120	200		○	○	○	○	○	○
				AC	125	3	105	115		—	○	○	○	○	—	
				DC	50	6	80	90		—	○	○	○	○	—	

Note: (1) For long lead types add the letter "L" at the end of the part number.

(2) The information of the Approved Safety Standards is furnished as of Jun. 2010.

Approved Safety Standards File No. UL:E60271, CSA:1687496(LR67163), VDE:481106-1171-0001, BEAB:C1144, CCC:2002010205004249

● F series



















































































Part No.	Type No. of Approved Standards	Rated Functioning Temp. : T _F *1 (°C)	Functioning Temp. *2 (°C)	Electrical Rating			Maximum Operating Temp. *3 (°C)	Holding Temp. : T _h *4 (°C)	Maximum Temp. Limit : T _m *5 (°C)	Approved Safety Standards						
				AC/DC	Volt. (V)	Amp. (A)					UL C-UL	CSA	VDE	BEAB	CCC	
EYP1BF101	F101	102	98±3	AC	250	1	65	75	200		○	○	○	○	○	○
				AC	125	2	60	70		—	○	○	○	○	—	
				DC	50	3.5	55	65		—	○	○	○	○	—	
EYP1BF115	F115	115	110 ⁺³ / ₋₂	AC	250	1	80	90	200		○	○	○	○	○	○
				AC	125	2	76	90		—	○	○	○	○	—	
				DC	50	4	70	80		—	○	○	○	○	—	
EYP1BF134	F134	134	129 ⁺⁴ / ₋₃	AC	250	1	90	105	200		○	○	○	○	○	○
				AC	125	2	85	100		—	○	○	○	○	—	
				DC	50	4	65	80		—	○	○	○	○	—	
EYP1BF138	F138	139	135±3	AC	250	1	100	110	200		○	○	○	○	○	○
				AC	125	2	90	105		—	○	○	○	○	—	
				DC	50	5	65	70		—	○	○	○	○	—	
EYP1BF145	F145	145	141±2	AC	250	1	110	125	200		○	○	○	○	○	○
				AC	125	2	110	125		—	○	○	○	○	—	
				DC	50	5	80	95		—	○	○	○	○	—	

Note: (1) For long lead types add the letter "L" at the end of the part number.

(2) The information of the Approved Safety Standards is furnished as of Jun. 2010.

Approved Safety Standards File No. UL/C-UL:E60271, CSA:1709436(LR67163), VDE:481106-1171-0003, BEAB:C1133, CCC:2002010205004248

● E series



























































































Part No.	Type No. of Approved Standards	Rated Functioning Temp. : T _F * ¹ (°C)	Functioning Temp. * ² (°C)	Electrical Rating			Maximum Operating Temp. * ³ (°C)	Holding Temp. : T _h * ⁴ (°C)	Maximum Temp. Limit : T _m * ⁵ (°C)	Approved Safety Standards					
				AC/DC	Volt. (V)	Amp. (A)					UL C-UL	CSA	VDE	BEAB	CCC
EYP05BE101	E101	102	98±3	AC	250	0.5	65	75	200						
				AC	125	1.5	60	70							
				DC	50	3	55	65							
EYP05BE115	E115	115	110±2	AC	250	0.5	80	95	200						
				AC	125	1.5	76	93							
				DC	50	3	70	84							
EYP05BE134	E134	134	129 ⁺⁴ / ₋₃	AC	250	0.5	90	105	200						
				AC	125	1.5	85	100							
				DC	50	3	70	85							
EYP05BE138	E138	139	135±3	AC	250	0.5	100	115	200						
				AC	125	1.5	95	110							
				DC	50	4	65	80							
EYP05BE145	E145	145	141±2	AC	250	0.5	110	125	200						
				AC	125	1.5	105	125							
				DC	50	5	80	95							

Note: (1) For long lead types add the letter "L" at the end of the part number.

(2) The information of the Approved Safety Standards is furnished as of Jun. 2010.

Approved Safety Standards File No. UL/C-UL:E60271, CSA:1709439(LR67163), VDE:481106-1171-0002, BEAB:C1139, CCC:2002010205004246

● H series

Part No.	Type No. of Approved Standards	Rated Functioning Temp. : T _F * ¹ (°C)	Functioning Temp. * ² (°C)	Electrical Rating			Maximum Operating Temp. * ³ (°C)	Holding Temp. : T _h * ⁴ (°C)	Maximum Temp. Limit : T _m * ⁵ (°C)	Approved Safety Standards					
				AC/DC	Volt. (V)	Amp. (A)					UL C-UL	CSA	VDE	BEAB	CCC
EYP2BH101	H101	102	98±3	AC	250	2	65	75	200						
				AC	125	3	60	70							
				DC	50	3.5	55	65							
EYP2BH115	H115	115	110±2	AC	250	2	80	90	200						
				AC	125	3	76	86							
				DC	50	3.5	74	84							
EYP2BH134	H134	134	129 ⁺⁴ / ₋₃	AC	250	2	90	95	200						
				AC	125	3	70	85							
				DC	50	3.5	65	80							
EYP2BH138	H138	139	135±3	AC	250	2	100	105	200						
				AC	125	3	80	95							
				DC	50	3.5	75	90							
EYP2BH145	H145	145	141±2	AC	250	2	110	125	200						
				AC	125	3	100	115							
				DC	50	4.5	85	100							

Note: (1) The information of the Approved Safety Standards is furnished as of Jun. 2010.

Approved Safety Standards File No. UL/C-UL:E60271, CSA:1709435(LR67163), VDE:481106-1171-0004, BEAB:C1140, CCC:2002010205004245

● MP series

Part No.	Rated Functioning Temp. : Tf*1 (°C)	Functioning Temp. *2 (°C)	Electrical Rating			Maximum Operating Temp. *3 (°C)	Holding Temp. : Th*4 (°C)	Maximum Temp. Limit : Tm*5 (°C)	Approved Safety Standards
			AC/DC	Volt. (V)	Amp. (A)				UL
EYP2MP092AFT	92	88 ⁺³ ₋₄	DC	32	2	55	60	135	○
EYP2MP098AFT	98	94 ⁺³ _{-2.5}	DC	32	2	60	65	135	○

Note: (1) The information of the Approved Safety Standards is furnished as of Jun. 2010.
Approved Safety Standards File No. UL:E60271

● MU series

Part No.	Rated Functioning Temp. : Tf*1 (°C)	Functioning Temp. *2 (°C)	Electrical Rating			Maximum Operating Temp. *3 (°C)	Holding Temp. : Th*4 (°C)	Maximum Temp. Limit : Tm*5 (°C)	Approved Safety Standards
			AC/DC	Volt. (V)	Amp. (A)				UL
EYP4MU092GFD	92	89 ⁺³ ₋₄	DC	32	4	55	55	135	○

Note: (1) The information of the Approved Safety Standards is furnished as of Jun. 2010.
Approved Safety Standards File No. UL:E60271

- *1 Rated Functioning Temperature (Tf)
The temperature at which a TCO changes its state of conductivity to open circuit with loading detection current only.
Tolerance: $\begin{matrix} \diamond \\ \text{±} \end{matrix}$; ±7 °C
UL,CSA,VDE, BEAB, CCC; $\begin{matrix} 0 \\ -10 \end{matrix}$ °C
- *2 Functioning Temperature (Fusing-off temperature)
The functioning temperature at which a TCO changes its state of conductivity to open circuit in the ambient air oven which increases temperature by 1 °C per minute and with loading the detective current 0.1 A or less.
- *3 Maximum Operating Temperature.
The maximum temperature at which a TCO can be maintained while conducting rated current for 1000 h.
For details please refer to specification.
- *4 Holding Temperature (Th)
The maximum temperature at which a TCO can be maintained while conducting rated current for 168 h which will not cause a change in state of conductivity to open circuit.
- *5 Maximum Temperature Limit (Tm)
The maximum temperature at which a TCO can maintains its mechanical and electrical properties without closing again for 10 minutes after a TCO has changed its state of conductivity.

■ Dimensions in mm (not to scale)

● Axial lead type

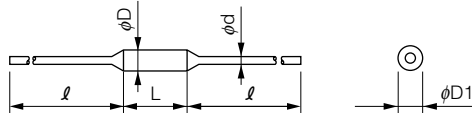

	Dimensions (mm)				
	L	φD	φD1	ℓ	φd
N Series	9.0±1.0	2.5±0.2	3 max.	38±3 (*78±3)	0.60±0.05
F Series	6.0±1.0	1.85 ^{+0.20} _{-0.15}	2.2 max.	38±3 (*68±3)	0.53±0.02
E Series	5.0±0.5	1.5±0.1	1.8 max.	38±3 (*68±3)	0.53±0.02

(*) For long lead types add the letter "L" at the end of the part number.

● Radial lead type

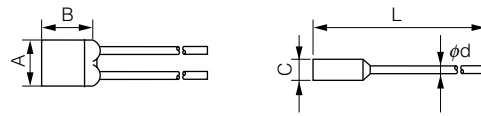

	Dimensions (mm)				
	A	B	C	L	φd
H Series	5.0±0.5	4.0±0.5	2.2±0.3	55±3	0.53±0.02

● Thin type

EYP2MP□□□AFT

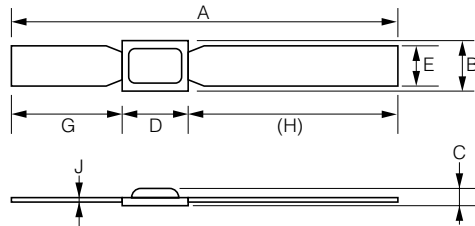

EYP4MU□□□GFD

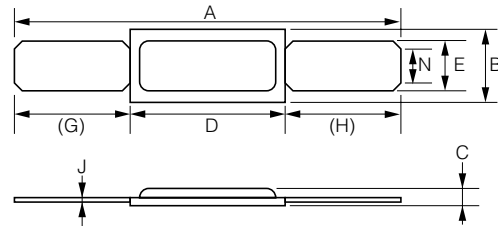

	Dimensions (mm)									
	A	B	C	D	E	G	(H)	J	N	
EYP2MP□□□AFT	24.5±0.5	2.7±0.2	0.64±0.15	4.2±0.5	2.3±0.2	7.9±0.5	(12.4)	0.10±0.02	-	
EYP4MU□□□GFD	26.5±0.5	4.5±0.4	1.00±0.15	10.5±0.5	3.0±0.2	(8.0)	(8.0)	0.15±0.02	1.8±0.5	

■ Marking

The following items are indicated on TCO.

- N, F, E, H Series : Type No., Date Code, Trade Mark, <PS>E Mark, JET, Rated Functioning Temperature, Rated Current
- MP, MU Series : Type No., Date Code, Trade Mark

■ Packaging Methods

Part No.	Standard Quantity	Style	Mass (Weight) [mg/pc.]
EYP2BN□□□	2000 pcs./Box	Bulk	340
EYP2BN□□□L	2000 pcs./Box		510
EYP1BF□□□	3000 pcs./Box		220
EYP1BF□□□L	4000 pcs./Box		330
EYP05BE□□□	4000 pcs./Box		210
EYP05BE□□□L	5000 pcs./Box		320
EYP2BH□□□	1500 pcs./Box		350
EYP2MP□□□AFT	2000 pcs./Box		54
EYP4MU□□□GFD	1000 pcs./Box		130

⚠ Safety Precautions (Handling Precautions)

The following are precautions for individual products. Please also refer to the common precautions for fuses shown on this catalog.

● Design Applications

1. Use the TCO within their specified temperature and electrical ratings.
 - 1) Use the TCO under the maximum operating temperature specified in the individual specification.
Using the TCO under a higher temperature than the maximum operating temperature may cause premature opening or opening delay.
 - When the TCO is continuously used at the temperature close to the functioning temperature, the TCO may operate while being used.
 - When the TCO is continuously used at the temperature higher than the maximum operation temperature, the TCO may be degraded and may not operate normally at the specified temperature.
 - 2) The holding temperature is defined as the highest temperature at which the TCO is activated continuously at the rated current for 168 hours. The TCO can not be used over 168 hours exceeding the holding temperature.
 - 3) Equipment should be designed so that its over shoot does not exceed the maximum temperature limit after the TCO operates.
 - 4) If the TCO is activated by voltage higher than the rated voltage or current higher than the rated current, the TCO produces excessive heat, resulting in premature opening. The arc generated at this condition of operation will result in an abnormality of appearance (crack on body) and insufficient insulation.
 - When TCO is operated in an abnormal mode while the rated voltage and/or the rated current being exceeded, it may not cut off the circuit.
 - 5) Thermal element may be transformed and TCO may open when it is used in the environment from which an excessive temperature change (such as outdoor) is repeated. Investigate the environment where TCO is used.
 - 6) Where transient overload is expected to be applied, repeat the tests under the worst conditions.
 - 7) The TCO cannot be used as a current sensitive fuse.
2. To fully use the function of the TCO, a suitable TCO for each equipment application must be selected.
 - 1) Tests should be repeated for the finished equipment to confirm that the TCO does operate as expected.
 - 2) To improve thermal response of the TCO, put the main body of the TCO and the lead wires (terminals) as close to the heat source as possible and the place where the TCO is evenly heated.
If the temperatures transferred to the main body and to the lead wires (terminals) are largely different from each other, improper operation can be expected, causing arcing and deterioration of insulation.
3. Avoid application of excessive vibration and mechanical stress to the TCO. Otherwise, failure of the fusible alloy or lead wires, or damage to the main body may result.
4. The following 1) and 2) are precautions for thin type TCO (MP and MU series)
 - 1) TCO body and terminals must be properly fixed when the TCO is mounted in the equipment. It may cause breaking of thermal element and/or terminals, or damages of the TCO body, or other failure when the body or terminals is not properly connected. Avoid a transport under the condition with a connection only a single side of terminal and the equipment as it might cause breaking of thermal element and/or terminals, or damages of the TCO body, or other failure due to the vibration or mechanical stress on the transportation.
 - 2) When TCO is mounted in the equipment, terminals must be aligned with the body. If TCO body and terminals are mutually mounted askew, it might cause breaking of thermal element and/or terminals. Also after assembling TCO in the equipment, avoid pulling, bending, pushing stress and twisting stress in the TCO body and terminals in order not to cause breaking of thermal element and/or terminals, or damages of the TCO body.
5. When sealing the TCO with resin, select a resin that does not corrode the seals or the lead wires (terminals). When sealing the overall TCO with resin, determine the fixing conditions by repeating the test using your final product to check whether or not the resin properties (e.g. expansion, contraction, and curing temperature) affect the TCO and whether or not the TCO can operate normally.
6. When immersing equipment with a TCO in varnish or solvent and then drying it, repeat the test to check whether or not the varnish or solvent used dissolved the coating of the TCO or caused damage, such as cracks, before performing the treatment again.
7. Do not use under the following environments.
 - 1) In liquids such as water, oil, chemical and organic solvents
 - 2) In direct sunlight, outdoors or in dusty atmospheres
 - 3) In places where water condensation occurs

* Use in the following environments may affect the performance of the TCO; Verify performance and reliability before production use.

 - (1) In places full of corrosive gases such as sea breeze, Cl₂, H₂S, NH₃, SO₂ and NO₂
 - (2) In environments with high static electricity and/or strong electromagnetic waves.
8. Do not use the TCO in aerospace equipment, atomic energy equipment, military weapons, life saving equipment, automobile, etc.

● Instruction

1. Forming and Cutting
 - 1) Lead wires (terminals) are to be bent or cut at least 3 mm away from the TCO seals to avoid damaging the TCO. (axial / radial type) or body (thin type). The TCO seals (axial / radial type) shall not be grasped with any tools or holders. Terminals of thin type TCO are to be grasped before they are bent. (See Fig.1)
 - 2) The lead wires and terminals shall not be nicked, fractured or burned.
The body and/or seals must not be damaged, burned or overheated.
 - 3) It is recommended that experimental assembly trials, should be done so that it can be verified that manufacturing procedures will not exceed the maximum tested "pull" and "push" forces of 20 N (MP series:5 N, MU series:10 N) and 5 N respectively on the lead wires (terminals), or induce excessive twisting or the like.
 - 4) Do not repeat bending terminals of thin type TCO.

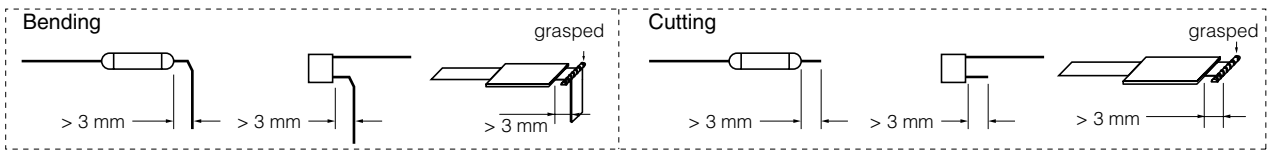

Fig-1

2. Soldering, Welding, Calking

- 1) Lead wires are to be soldered with the standard conditions shown in Table 1.
Excessive soldering heat and soldering time may cause damage to a TCO.
If higher temperature, longer time or shorter lead length exist rather than the conditions of Table 1, it is recommended to run tests for finding the soldering conditions that do not damage the TCO. Also, use of tools such as pliers are recommended to dissipate the soldering heat by grasping lead wires between the TCO body and soldering point.
- 2) Avoid preheating and gradual cooling as much as possible. However if preheating and gradual cooling is done, set the process conditions after confirming that the TCO is not affected by these procedures.
- 3) Do not use reflow soldering.
- 4) Thin type (MP and MU series) is not to be soldered.
- 5) If water or solvent is used for cleaning flux after soldering, check and confirm the reliability of the agent.
- 6) Lead wires are to be clamped at least 3 mm away from the seals.
Improper connections may cause damage to the seals or other parts and may result in nuisance tripping of the devices due to the generation of excessive heat at a faulty high resistance junction.
- 7) Set the conditions for welding and calking only after checking contact resistance and connection strength.
- 8) When resoldering or rewelding, cool the TCO under room conditions.
- 9) When the TCO is heated by soldering or welding, be careful not to pull, push or twist the TCO lead wires.

Table-1 Soldering Conditions

Temperature of Soldering: 300 °C Time: 3 s				
Lead Length (ℓ)	Type No.			
30 mm		F101	E101	H101
25 mm	N082, N099		E115, E134, E138	H115, H134, H138
20 mm	N109, N110	F115, F134, F138, F145	E145	H145
15 mm	N127, N134, N143			

3. The use of sufficiently flexible, appropriate free length and proper size wire should be used for splice connection. Connection including connectors used for splicing shall be of the low resistance type, and they shall be made mechanically secure.
4. Where the lead wires of the TCO is tied with string, put them at least 10 mm apart from the seals of the main body of the TCO.
5. Quality control notes.
 - 1) Measurement of resistance between lead wires (terminals) and checking of the internal status with X-rays are effective means to confirm the status of the TCO on delivery and after mounting in the equipment.
6. Storage method
 - 1) Store the TCO in packing cases or in polyethylene bags within the temperature range -10 °C to +40 °C and RH of 30 % to 75 %. Store them at a location where no rapid changes of temperature or humidity or no direct sunlight is applied. The location must also be free from vibration and shock .
 - 2) Avoid storage in places containing corrosive gases such as sea breeze, Cl₂, H₂S, NH₃, SO₂ and NO₂.
 - 3) The period of guarantee for performance such as solderability is for one year after our delivery; and this condition applies only in the case where the storage method specified in above has been followed.
7. Do not repair a TCO. Replace it with a new part.

⚠ Safety Precautions (Common precautions for fuses)

- When using our products, no matter what sort of equipment they might be used for, be sure to make a written agreement on the specifications with us in advance. The design and specifications in this catalog are subject to change without prior notice.
- Do not use the products beyond the specifications described in this catalog.
- This catalog explains the quality and performance of the products as individual components. Before use, check and evaluate their operations when installed in your products.
- Install the following systems for a failsafe design to ensure safety if these products are to be used in equipment where a defect in these products may cause the loss of human life or other significant damage, such as damage to vehicles (automobile, train, vessel), traffic lights, medical equipment, aerospace equipment, electric heating appliances, combustion/gas equipment, rotating equipment, and disaster/crime prevention equipment.
- * Systems equipped with a protection circuit and a protection device
- * Systems equipped with a redundant circuit or other system to prevent an unsafe status in the event of a single fault

(1) Precautions for use

- These products are designed and manufactured for general and standard use in general electronic equipment (e.g. AV equipment, home electric appliances, office equipment, information and communication equipment)
- These products are not intended for use in the following special conditions. Before using the products, carefully check the effects on their quality and performance, and determine whether or not they can be used.
 1. In liquid, such as water, oil, chemicals, or organic solvent
 2. In direct sunlight, outdoors, or in dust
 3. In salty air or air with a high concentration of corrosive gas, such as Cl₂, H₂S, NH₃, SO₂, or NO₂
 4. Electric Static Discharge (ESD) Environment
These components are sensitive to static electricity and can be damaged under static shock (ESD). Please take measures to avoid any of these environments.
Smaller components are more sensitive to ESD environment.
 5. Electromagnetic Environment
Avoid any environment where strong electromagnetic waves exist.
 6. In an environment where these products cause dew condensation
 7. Sealing or coating of these products or a printed circuit board on which these products are mounted, with resin or other materials
- These products generate Joule heat when energized. Carefully position these products so that their heat will not affect the other components (except Thermal Cutoffs).
- Carefully position these products so that their temperatures will not exceed the category temperature range due to the effects of neighboring heat-generating components. Do not mount or place heat-generating components or inflammables, such as vinyl-coated wires, near these products (except Thermal Cutoffs).
- Note that non-cleaning solder, halogen-based highly active flux, or water-soluble flux may deteriorate the performance or reliability of the products.
- Carefully select a flux cleaning agent for use after soldering. An unsuitable agent may deteriorate the performance or reliability. In particular, when using water or a water-soluble cleaning agent, be careful not to leave water residues. Otherwise, the insulation performance may be deteriorated.

(2) Precautions for storage

The performance of these products, including the solderability, is guaranteed for a year from the date of arrival at your company, provided that they remain packed as they were when delivered and stored at a temperature of 5 °C to 35 °C and a relative humidity of 45 % to 85 %.

The performance of Thermal Cutoffs is guaranteed for a year after our delivery, provided that they are stored at a temperature of -10 °C to +40 °C and a relative humidity of 30 % to 75 %.

Even within the above guarantee periods, do not store these products in the following conditions. Otherwise, their electrical performance and/or solderability may be deteriorated, and the packaging materials (e.g. taping materials) may be deformed or deteriorated, resulting in mounting failures.

1. In salty air or in air with a high concentration of corrosive gas, such as Cl₂, H₂S, NH₃, SO₂, or NO₂
2. In direct sunlight

<Package markings>

Package markings include the product number, quantity, and country of origin.

In principle, the country of origin should be indicated in English.

Mouser Electronics

Authorized Distributor

Click to View Pricing, Inventory, Delivery & Lifecycle Information:

[Panasonic:](#)

[EYP-2ML098U](#) [EYP-1BF115](#)