

HEX BUFFER/DRIVER WITH OPEN-DRAIN OUTPUTS

 Check for Samples: [SN74LVC07A](#)

FEATURES

- Operates From 1.65 V to 5 V
- Inputs and Open-Drain Outputs Accept Voltages up to 5.5 V
- Max t_{pd} of 2.6 ns at 5 V
- Latch-Up Performance Exceeds 250 mA Per JESD 17

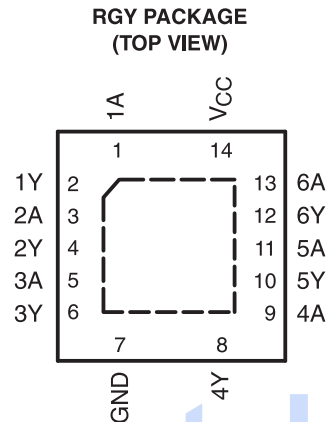
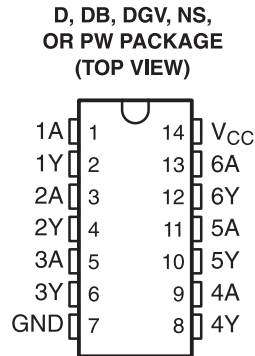

DESCRIPTION/ORDERING INFORMATION

This hex buffer/driver is designed for 1.65-V to 5.5-V V_{CC} operation.

The outputs of the SN74LVC07A device are open drain and can be connected to other open-drain outputs to implement active-low wired-OR or active-high wired-AND functions. The maximum sink current is 24 mA.

Inputs can be driven from 1.8-V, 2.5-V, 3.3-V (LVTTTL), or 5-V (CMOS) devices. This feature allows the use of this device as translators in a mixed-system environment.

ORDERING INFORMATION

T_A	PACKAGE ^{(1) (2)}		ORDERABLE PART NUMBER	TOP-SIDE MARKING
-40°C to 85°C	QFN – RGY	Reel of 1000	SN74LVC07ARGYR	LC07A
	SOIC – D	Tube of 50	SN74LVC07AD	LVC07A
		Reel of 2500	SN74LVC07ADRG3	
		Reel of 250	SN74LVC07ADT	
	SOP – NS	Reel of 2000	SN74LVC07ANSR	LVC07A
	SSOP – DB	Reel of 2000	SN74LVC07ADBR	LC07A
	TSSOP – PW	Tube of 90	SN74LVC07APW	LC07A
		Reel of 2000	SN74LVC07APWRG3	
		Reel of 250	SN74LVC07APWT	
	TVSOP – DGV	Reel of 2000	SN74LVC07ADGVR	LC07A

(1) Package drawings, thermal data, and symbolization are available at www.ti.com/packaging.

(2) For the most current package and ordering information, see the Package Option Addendum at the end of this document, or see the TI website at www.ti.com.



Please be aware that an important notice concerning availability, standard warranty, and use in critical applications of Texas Instruments semiconductor products and disclaimers thereto appears at the end of this data sheet.



These devices have limited built-in ESD protection. The leads should be shorted together or the device placed in conductive foam during storage or handling to prevent electrostatic damage to the MOS gates.

**FUNCTION TABLE
(EACH BUFFER/DRIVER)**

INPUT A	OUTPUT Y
H	H
L	L

LOGIC DIAGRAM, EACH BUFFER/DRIVER (POSITIVE LOGIC)



ABSOLUTE MAXIMUM RATINGS⁽¹⁾

over operating free-air temperature range (unless otherwise noted)

		MIN	MAX	UNIT
V_{CC}	Supply voltage range	-0.5	6.5	V
V_I	Input voltage range ⁽²⁾	-0.5	6.5	V
V_O	Output voltage range	-0.5	6.5	V
I_{IK}	Input clamp current		-50	mA
I_{OK}	Output clamp current		-50	mA
I_O	Continuous output current		±50	mA
	Continuous current through V_{CC} or GND		±100	mA
T_{stg}	Storage temperature range	-65	150	°C

- (1) Stresses beyond those listed under "absolute maximum ratings" may cause permanent damage to the device. These are stress ratings only, and functional operation of the device at these or any other conditions beyond those indicated under "recommended operating conditions" is not implied. Exposure to absolute-maximum-rated conditions for extended periods may affect device reliability.
- (2) The input and output negative-voltage ratings may be exceeded if the input and output current ratings are observed.

THERMAL INFORMATION

THERMAL METRIC ⁽¹⁾	SN74LVC07A						UNITS	
	(14) PINS							
	D	DB	DGV	NS	PW	RGY		
θ_{JA}	Junction-to-ambient thermal resistance	120.8	135.1	157.7	120.3	151.5	79.4	°C/W
θ_{JcTop}	Junction-to-case (top) thermal resistance	79.7	86.7	78.3	76.3	77.6	95.7	
θ_{JB}	Junction-to-board thermal resistance	75.1	82.4	90.8	79	92.3	55.4	
ψ_{JT}	Junction-to-top characterization parameter	37.2	43.7	21	36.2	21	16.4	
ψ_{JB}	Junction-to-board characterization parameter	74.8	81.9	90.1	78.7	92.7	55.6	
θ_{JcBot}	Junction-to-case (bottom) thermal resistance	n/a	n/a	n/a	n/a	n/a	34.8	

- (1) For more information about traditional and new thermal metrics, see the *IC Package Thermal Metrics* application report, [SPRA953](#).

RECOMMENDED OPERATING CONDITIONS⁽¹⁾

		MIN	MAX	UNIT
V _{CC}	Supply voltage	1.65	5.5	V
V _{IH}	High-level input voltage	V _{CC} = 1.65 V to 1.95 V	0.65 × V _{CC}	V
		V _{CC} = 2.3 V to 2.7 V	1.7	
		V _{CC} = 2.7 V to 3.6 V	2	
		V _{CC} = 4.5 V to 5.5 V	0.7 × V _{CC}	
V _{IL}	Low-level input voltage	V _{CC} = 1.65 V to 1.95 V	0.35 × V _{CC}	V
		V _{CC} = 2.3 V to 2.7 V	0.7	
		V _{CC} = 2.7 V to 3.6 V	0.8	
		V _{CC} = 4.5 V to 5.5 V	0.3 × V _{CC}	
V _I	Input voltage	0	5.5	V
V _O	Output voltage	0	5.5	V
I _{OL}	Low-level output current	V _{CC} = 1.65 V	4	mA
		V _{CC} = 2.3 V	12	
		V _{CC} = 2.7 V	12	
		V _{CC} = 3 V	24	
		V _{CC} = 4.5 V	24	
T _A	Operating free-air temperature	−40	85	°C

(1) All unused inputs of the device must be held at V_{CC} or GND to ensure proper device operation. Refer to the TI application report, *Implications of Slow or Floating CMOS Inputs*, literature number SCBA004.

ELECTRICAL CHARACTERISTICS

over recommended operating free-air temperature range (unless otherwise noted)

PARAMETER	TEST CONDITIONS	V _{CC}	MIN	TYP ⁽¹⁾	MAX	UNIT
V _{OL}	I _{OL} = 100 μA	1.65 V to 5.5 V			0.2	V
	I _{OL} = 4 mA	1.65 V			0.45	
	I _{OL} = 12 mA	2.3 V			0.7	
		2.7 V			0.4	
	I _{OL} = 24 mA	3 V			0.55	
I _I	V _I = 5.5 V or GND	3.6 V			±5	μA
I _{off}	V _I or V _O = 5.5 V	0 V			±10	μA
I _{CC}	V _I = V _{CC} or GND, I _O = 0	3.6 V			10	μA
ΔI _{CC}	One input at V _{CC} − 0.6 V, Other inputs at V _{CC} or GND	2.7 V to 3.6 V			500	μA
C _i	V _I = V _{CC} or GND	3.3 V		5		pF

(1) All typical values are at V_{CC} = 3.3 V, T_A = 25°C.

SWITCHING CHARACTERISTICS

over recommended operating free-air temperature range (unless otherwise noted) (see [Figure 1](#) through [Figure 4](#))

PARAMETER	FROM (INPUT)	TO (OUTPUT)	V _{CC} = 1.8 V ± 0.15 V		V _{CC} = 2.5 V ± 0.2 V		V _{CC} = 2.7 V		V _{CC} = 3.3 V ± 0.3 V		V _{CC} = 5 V ± 0.5 V		UNIT
			MIN	MAX	MIN	MAX	MIN	MAX	MIN	MAX	MIN	MAX	
t _{pd}	A	Y	1	5.6	1	3.4	3.3		1	3.6	1	2.6	ns

OPERATING CHARACTERISTICS

T_A = 25°C

PARAMETER	TEST CONDITIONS	V _{CC} = 1.8 V	V _{CC} = 2.5 V	V _{CC} = 3.3 V	V _{CC} = 5 V	UNIT
		TYP	TYP	TYP	TYP	
C _{pd}	Power dissipation capacitance per buffer/driver f = 10 MHz	1.8	2	2.5	3.78	pF

PARAMETER MEASUREMENT INFORMATION

$V_{CC} = 1.8 V \pm 0.15 V$

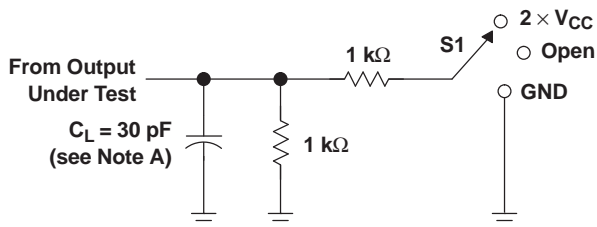

LOAD CIRCUIT

TEST	S1
t_{PZL} (see Note F)	$2 \times V_{CC}$
t_{PLZ} (see Note G)	$2 \times V_{CC}$
t_{PHZ}/t_{PZH}	$2 \times V_{CC}$



**VOLTAGE WAVEFORMS
SETUP AND HOLD TIMES**

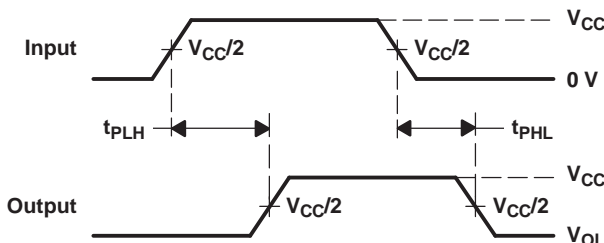

**VOLTAGE WAVEFORMS
PROPAGATION DELAY TIMES**

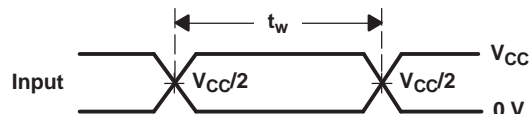

**VOLTAGE WAVEFORMS
PULSE DURATION**

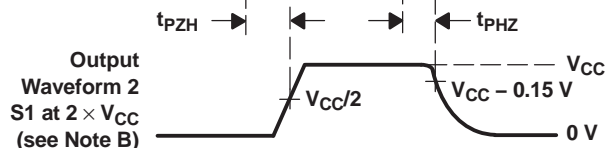
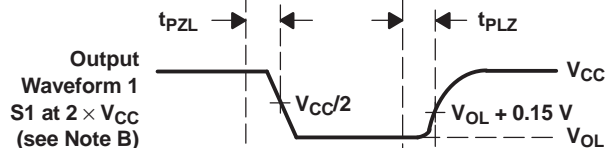
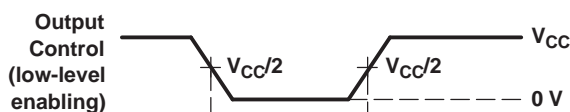

**VOLTAGE WAVEFORMS
ENABLE AND DISABLE TIMES**

- NOTES: A. C_L includes probe and jig capacitance.
 B. Waveform 1 is for an output with internal conditions such that the output is low, except when disabled by the output control. Waveform 2 is for an output with internal conditions such that the output is high, except when disabled by the output control.
 C. All input pulses are supplied by generators having the following characteristics: $PRR \leq 10 \text{ MHz}$, $Z_O = 50 \Omega$, $t_r \leq 2 \text{ ns}$, $t_f \leq 2 \text{ ns}$.
 D. The outputs are measured one at a time, with one transition per measurement.
 E. Since this device has open-drain outputs, t_{PLZ} and t_{PZL} are the same as t_{pd} .
 F. t_{PZL} is measured at $V_{CC}/2$.
 G. t_{PLZ} is measured at $V_{OL} + 0.15 \text{ V}$.
 H. All parameters and waveforms are not applicable to all devices.

Figure 1. Load Circuit and Voltage Waveforms

PARAMETER MEASUREMENT INFORMATION

$V_{CC} = 2.5\text{ V} \pm 0.2\text{ V}$

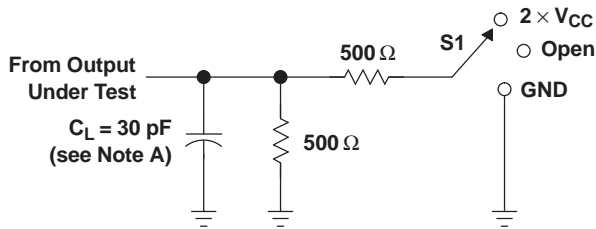

LOAD CIRCUIT

TEST	S1
t_{pZL} (see Note F)	$2 \times V_{CC}$
t_{pLZ} (see Note G)	$2 \times V_{CC}$
t_{pHZ}/t_{pZH}	$2 \times V_{CC}$

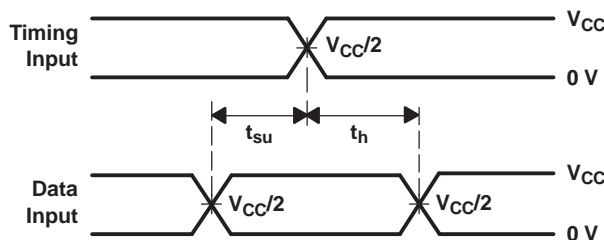

VOLTAGE WAVEFORMS SETUP AND HOLD TIMES

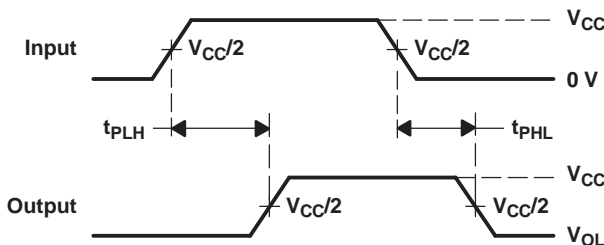

VOLTAGE WAVEFORMS PROPAGATION DELAY TIMES

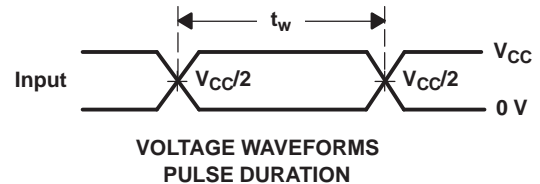

VOLTAGE WAVEFORMS PULSE DURATION

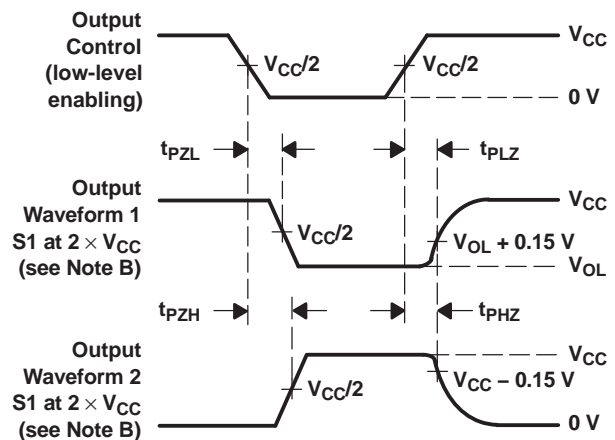

VOLTAGE WAVEFORMS ENABLE AND DISABLE TIMES

- NOTES: A. C_L includes probe and jig capacitance.
 B. Waveform 1 is for an output with internal conditions such that the output is low, except when disabled by the output control. Waveform 2 is for an output with internal conditions such that the output is high, except when disabled by the output control.
 C. All input pulses are supplied by generators having the following characteristics: $PRR \leq 10\text{ MHz}$, $Z_O = 50\ \Omega$, $t_r \leq 2\text{ ns}$, $t_f \leq 2\text{ ns}$.
 D. The outputs are measured one at a time, with one transition per measurement.
 E. Since this device has open-drain outputs, t_{pLZ} and t_{pZL} are the same as t_{pd} .
 F. t_{pZL} is measured at $V_{CC}/2$.
 G. t_{pLZ} is measured at $V_{OL} + 0.15\text{ V}$.
 H. All parameters and waveforms are not applicable to all devices.

Figure 2. Load Circuit and Voltage Waveforms

PARAMETER MEASUREMENT INFORMATION

$V_{CC} = 2.7 \text{ and } 3.3 \text{ V} \pm 0.3 \text{ V}$

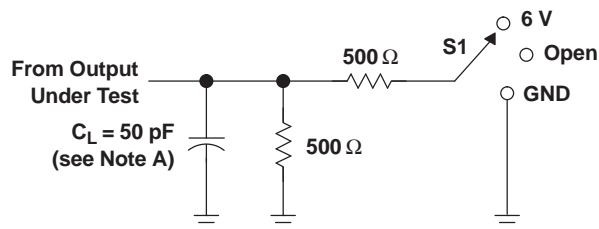

LOAD CIRCUIT

TEST	S1
t_{pZL} (see Note F)	6 V
t_{pLZ} (see Note G)	6 V
t_{PHZ}/t_{PZH}	6 V

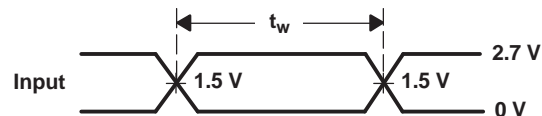

VOLTAGE WAVEFORMS PULSE DURATION

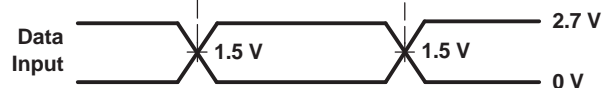

VOLTAGE WAVEFORMS SETUP AND HOLD TIMES

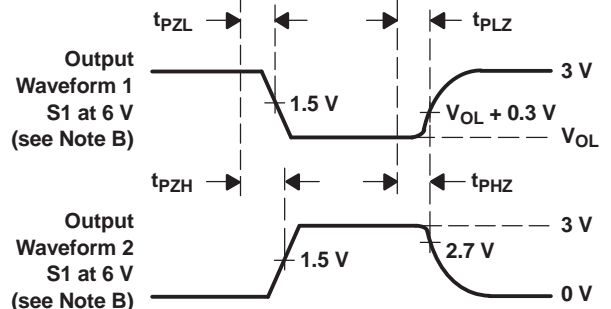
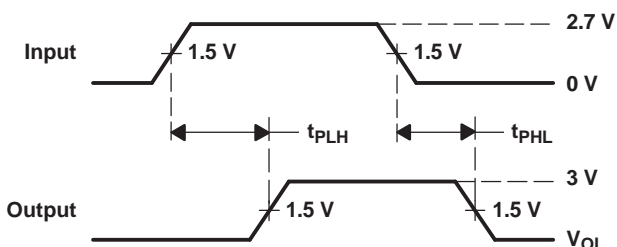

VOLTAGE WAVEFORMS PROPAGATION DELAY TIMES

VOLTAGE WAVEFORMS ENABLE AND DISABLE TIMES

- NOTES: A. C_L includes probe and jig capacitance.
 B. Waveform 1 is for an output with internal conditions such that the output is low, except when disabled by the output control. Waveform 2 is for an output with internal conditions such that the output is high, except when disabled by the output control.
 C. All input pulses are supplied by generators having the following characteristics: $PRR \leq 10 \text{ MHz}$, $Z_O = 50 \Omega$, $t_r \leq 2.5 \text{ ns}$, $t_f \leq 2.5 \text{ ns}$.
 D. The outputs are measured one at a time, with one transition per measurement.
 E. Since this device has open-drain outputs, t_{pLZ} and t_{pZL} are the same as t_{pd} .
 F. t_{pZL} is measured at 1.5 V.
 G. t_{pLZ} is measured at $V_{OL} + 0.3 \text{ V}$.
 H. All parameters and waveforms are not applicable to all devices.

Figure 3. Load Circuit and Voltage Waveforms

PARAMETER MEASUREMENT INFORMATION
 $V_{CC} = 5\text{ V} \pm 0.5\text{ V}$

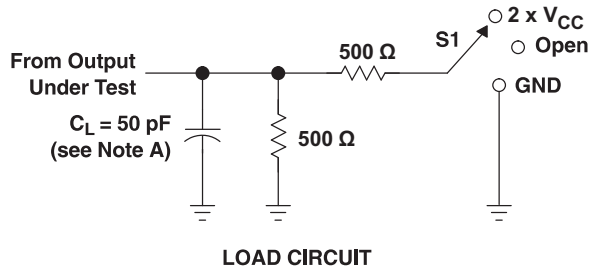

LOAD CIRCUIT

TEST	S1
t_{PZL} (see Note F)	$2 \times V_{CC}$
t_{PLZ} (see Note G)	$2 \times V_{CC}$
t_{PHZ}/t_{PZH}	$2 \times V_{CC}$

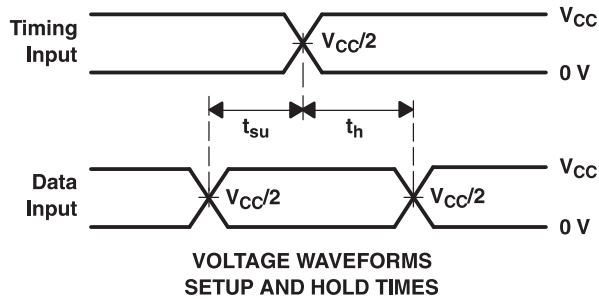

VOLTAGE WAVEFORMS
 SETUP AND HOLD TIMES

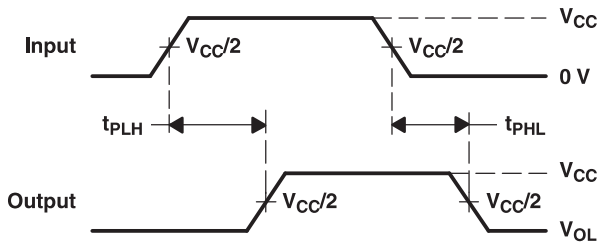

VOLTAGE WAVEFORMS
 PROPAGATION DELAY TIMES

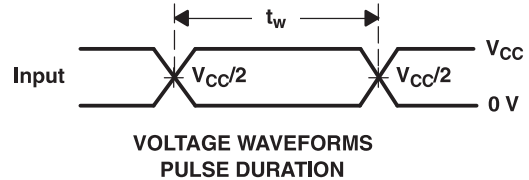

VOLTAGE WAVEFORMS
 PULSE DURATION

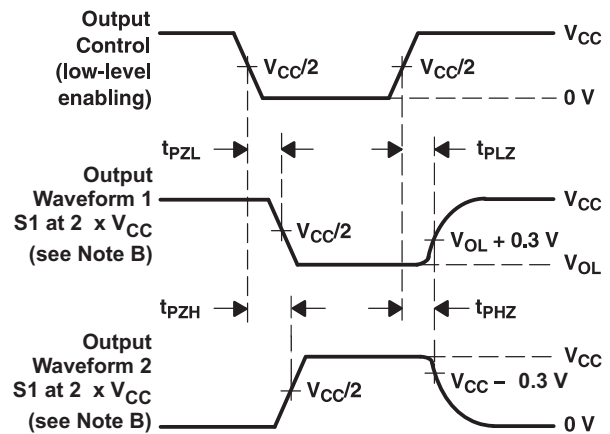

VOLTAGE WAVEFORMS
 ENABLE AND DISABLE TIMES

- NOTES: A. C_L includes probe and jig capacitance.
 B. Waveform 1 is for an output with internal connections such that the output is low, except when disabled by the output control. Waveform 2 is for an output with internal connections such that the output is high, except when disabled by the output control.
 C. All input pulses are supplied by generators having the following characteristics: $PRR \leq 10\text{ MHz}$, $Z_O = 50\ \Omega$, $t_r \leq 2.5\text{ ns}$, $t_f \leq 2.5\text{ ns}$.
 D. The outputs are measured one at a time, with one transition per measurement.
 E. Since this device has open-drain outputs, t_{PLZ} and t_{PZL} are the same as t_{pd} .
 F. t_{PZL} is measured at $V_{CC}/2$.
 G. t_{PLZ} is measured at $V_{OL} + 0.3\text{ V}$.
 H. All parameters and waveforms are not applicable to all devices.

Figure 4. Load Circuit and Voltage Waveforms

PACKAGING INFORMATION

Orderable Device	Status ⁽¹⁾	Package Type	Package Drawing	Pins	Package Qty	Eco Plan ⁽²⁾	Lead/ Ball Finish	MSL Peak Temp ⁽³⁾	Samples (Requires Login)
SN74LVC07AD	ACTIVE	SOIC	D	14	50	Green (RoHS & no Sb/Br)	CU NIPDAU	Level-1-260C-UNLIM	Purchase Samples
SN74LVC07ADBR	ACTIVE	SSOP	DB	14	2000	Green (RoHS & no Sb/Br)	CU NIPDAU	Level-1-260C-UNLIM	Contact TI Distributor or Sales Office
SN74LVC07ADBRG4	ACTIVE	SSOP	DB	14	2000	Green (RoHS & no Sb/Br)	CU NIPDAU	Level-1-260C-UNLIM	Contact TI Distributor or Sales Office
SN74LVC07ADE4	ACTIVE	SOIC	D	14	50	Green (RoHS & no Sb/Br)	CU NIPDAU	Level-1-260C-UNLIM	Purchase Samples
SN74LVC07ADG4	ACTIVE	SOIC	D	14	50	Green (RoHS & no Sb/Br)	CU NIPDAU	Level-1-260C-UNLIM	Purchase Samples
SN74LVC07ADGVR	ACTIVE	TVSOP	DGV	14	2000	Green (RoHS & no Sb/Br)	CU NIPDAU	Level-1-260C-UNLIM	Contact TI Distributor or Sales Office
SN74LVC07ADGVRE4	ACTIVE	TVSOP	DGV	14	2000	Green (RoHS & no Sb/Br)	CU NIPDAU	Level-1-260C-UNLIM	Contact TI Distributor or Sales Office
SN74LVC07ADGVRG4	ACTIVE	TVSOP	DGV	14	2000	Green (RoHS & no Sb/Br)	CU NIPDAU	Level-1-260C-UNLIM	Contact TI Distributor or Sales Office
SN74LVC07ADR	ACTIVE	SOIC	D	14	2500	Green (RoHS & no Sb/Br)	CU NIPDAU	Level-1-260C-UNLIM	Contact TI Distributor or Sales Office
SN74LVC07ADRE4	ACTIVE	SOIC	D	14	2500	Green (RoHS & no Sb/Br)	CU NIPDAU	Level-1-260C-UNLIM	Contact TI Distributor or Sales Office
SN74LVC07ADRG3	ACTIVE	SOIC	D	14	2500	Green (RoHS & no Sb/Br)	CU SN	Level-1-260C-UNLIM	Request Free Samples
SN74LVC07ADRG4	ACTIVE	SOIC	D	14	2500	Green (RoHS & no Sb/Br)	CU NIPDAU	Level-1-260C-UNLIM	Contact TI Distributor or Sales Office
SN74LVC07ADT	ACTIVE	SOIC	D	14	250	Green (RoHS & no Sb/Br)	CU NIPDAU	Level-1-260C-UNLIM	Purchase Samples
SN74LVC07ADTE4	ACTIVE	SOIC	D	14	250	Green (RoHS & no Sb/Br)	CU NIPDAU	Level-1-260C-UNLIM	Purchase Samples
SN74LVC07ADTG4	ACTIVE	SOIC	D	14	250	Green (RoHS & no Sb/Br)	CU NIPDAU	Level-1-260C-UNLIM	Purchase Samples
SN74LVC07ANSR	ACTIVE	SO	NS	14	2000	Green (RoHS & no Sb/Br)	CU NIPDAU	Level-1-260C-UNLIM	Purchase Samples
SN74LVC07ANSRE4	ACTIVE	SO	NS	14	2000	Green (RoHS & no Sb/Br)	CU NIPDAU	Level-1-260C-UNLIM	Purchase Samples

Orderable Device	Status ⁽¹⁾	Package Type	Package Drawing	Pins	Package Qty	Eco Plan ⁽²⁾	Lead/ Ball Finish	MSL Peak Temp ⁽³⁾	Samples (Requires Login)
SN74LVC07ANSRG4	ACTIVE	SO	NS	14	2000	Green (RoHS & no Sb/Br)	CU NIPDAU	Level-1-260C-UNLIM	Purchase Samples
SN74LVC07APW	ACTIVE	TSSOP	PW	14	90	Green (RoHS & no Sb/Br)	CU NIPDAU	Level-1-260C-UNLIM	Purchase Samples
SN74LVC07APWE4	ACTIVE	TSSOP	PW	14	90	Green (RoHS & no Sb/Br)	CU NIPDAU	Level-1-260C-UNLIM	Purchase Samples
SN74LVC07APWG4	ACTIVE	TSSOP	PW	14	90	Green (RoHS & no Sb/Br)	CU NIPDAU	Level-1-260C-UNLIM	Purchase Samples
SN74LVC07APWLE	OBSOLETE	TSSOP	PW	14		TBD	Call TI	Call TI	Samples Not Available
SN74LVC07APWR	ACTIVE	TSSOP	PW	14	2000	Green (RoHS & no Sb/Br)	CU NIPDAU	Level-1-260C-UNLIM	Contact TI Distributor or Sales Office
SN74LVC07APWRE4	ACTIVE	TSSOP	PW	14	2000	Green (RoHS & no Sb/Br)	CU NIPDAU	Level-1-260C-UNLIM	Contact TI Distributor or Sales Office
SN74LVC07APWRG3	ACTIVE	TSSOP	PW	14	2000	Green (RoHS & no Sb/Br)	CU SN	Level-1-260C-UNLIM	Request Free Samples
SN74LVC07APWRG4	ACTIVE	TSSOP	PW	14	2000	Green (RoHS & no Sb/Br)	CU NIPDAU	Level-1-260C-UNLIM	Contact TI Distributor or Sales Office
SN74LVC07APWT	ACTIVE	TSSOP	PW	14	250	Green (RoHS & no Sb/Br)	CU NIPDAU	Level-1-260C-UNLIM	Purchase Samples
SN74LVC07APWTE4	ACTIVE	TSSOP	PW	14	250	Green (RoHS & no Sb/Br)	CU NIPDAU	Level-1-260C-UNLIM	Purchase Samples
SN74LVC07APWTG4	ACTIVE	TSSOP	PW	14	250	Green (RoHS & no Sb/Br)	CU NIPDAU	Level-1-260C-UNLIM	Purchase Samples
SN74LVC07ARGYR	ACTIVE	VQFN	RGY	14	3000	Green (RoHS & no Sb/Br)	CU NIPDAU	Level-2-260C-1 YEAR	Request Free Samples
SN74LVC07ARGYRG4	ACTIVE	VQFN	RGY	14	3000	Green (RoHS & no Sb/Br)	CU NIPDAU	Level-2-260C-1 YEAR	Request Free Samples

⁽¹⁾ The marketing status values are defined as follows:

ACTIVE: Product device recommended for new designs.

LIFEBUY: TI has announced that the device will be discontinued, and a lifetime-buy period is in effect.

NRND: Not recommended for new designs. Device is in production to support existing customers, but TI does not recommend using this part in a new design.

PREVIEW: Device has been announced but is not in production. Samples may or may not be available.

OBSOLETE: TI has discontinued the production of the device.

⁽²⁾ Eco Plan - The planned eco-friendly classification: Pb-Free (RoHS), Pb-Free (RoHS Exempt), or Green (RoHS & no Sb/Br) - please check <http://www.ti.com/productcontent> for the latest availability information and additional product content details.

TBD: The Pb-Free/Green conversion plan has not been defined.

Pb-Free (RoHS): TI's terms "Lead-Free" or "Pb-Free" mean semiconductor products that are compatible with the current RoHS requirements for all 6 substances, including the requirement that lead not exceed 0.1% by weight in homogeneous materials. Where designed to be soldered at high temperatures, TI Pb-Free products are suitable for use in specified lead-free processes.

Pb-Free (RoHS Exempt): This component has a RoHS exemption for either 1) lead-based flip-chip solder bumps used between the die and package, or 2) lead-based die adhesive used between the die and leadframe. The component is otherwise considered Pb-Free (RoHS compatible) as defined above.

Green (RoHS & no Sb/Br): TI defines "Green" to mean Pb-Free (RoHS compatible), and free of Bromine (Br) and Antimony (Sb) based flame retardants (Br or Sb do not exceed 0.1% by weight in homogeneous material)

⁽³⁾ MSL, Peak Temp. -- The Moisture Sensitivity Level rating according to the JEDEC industry standard classifications, and peak solder temperature.

Important Information and Disclaimer:The information provided on this page represents TI's knowledge and belief as of the date that it is provided. TI bases its knowledge and belief on information provided by third parties, and makes no representation or warranty as to the accuracy of such information. Efforts are underway to better integrate information from third parties. TI has taken and continues to take reasonable steps to provide representative and accurate information but may not have conducted destructive testing or chemical analysis on incoming materials and chemicals. TI and TI suppliers consider certain information to be proprietary, and thus CAS numbers and other limited information may not be available for release.

In no event shall TI's liability arising out of such information exceed the total purchase price of the TI part(s) at issue in this document sold by TI to Customer on an annual basis.

OTHER QUALIFIED VERSIONS OF SN74LVC07A :

- Automotive: [SN74LVC07A-Q1](#)
- Enhanced Product: [SN74LVC07A-EP](#)

NOTE: Qualified Version Definitions:

- Automotive - Q100 devices qualified for high-reliability automotive applications targeting zero defects
- Enhanced Product - Supports Defense, Aerospace and Medical Applications

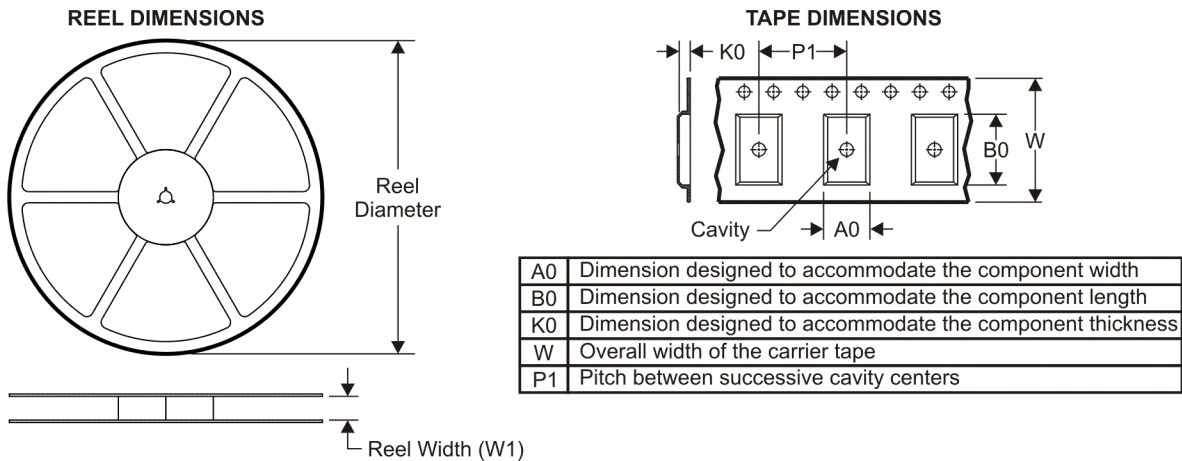
TAPE AND REEL INFORMATION

QUADRANT ASSIGNMENTS FOR PIN 1 ORIENTATION IN TAPE

*All dimensions are nominal

Device	Package Type	Package Drawing	Pins	SPQ	Reel Diameter (mm)	Reel Width W1 (mm)	A0 (mm)	B0 (mm)	K0 (mm)	P1 (mm)	W (mm)	Pin1 Quadrant
SN74LVC07ADBR	SSOP	DB	14	2000	330.0	16.4	8.2	6.6	2.5	12.0	16.0	Q1
SN74LVC07ADGVR	TVSOP	DGV	14	2000	330.0	12.4	6.8	4.0	1.6	8.0	12.0	Q1
SN74LVC07ADR	SOIC	D	14	2500	330.0	16.4	6.5	9.0	2.1	8.0	16.0	Q1
SN74LVC07ADR	SOIC	D	14	2500	330.0	16.4	6.5	9.0	2.1	8.0	16.0	Q1
SN74LVC07ADT	SOIC	D	14	250	330.0	16.4	6.5	9.0	2.1	8.0	16.0	Q1
SN74LVC07ANSR	SO	NS	14	2000	330.0	16.4	8.2	10.5	2.5	12.0	16.0	Q1
SN74LVC07APWR	TSSOP	PW	14	2000	330.0	12.4	6.9	5.6	1.6	8.0	12.0	Q1
SN74LVC07APWR	TSSOP	PW	14	2000	330.0	12.4	7.0	5.6	1.6	8.0	12.0	Q1
SN74LVC07APWRG3	TSSOP	PW	14	2000	330.0	12.4	7.0	5.6	1.6	8.0	12.0	Q1
SN74LVC07APWT	TSSOP	PW	14	250	330.0	12.4	6.9	5.6	1.6	8.0	12.0	Q1
SN74LVC07ARGYR	VQFN	RGY	14	3000	330.0	12.4	3.75	3.75	1.15	8.0	12.0	Q1

TAPE AND REEL BOX DIMENSIONS

*All dimensions are nominal

Device	Package Type	Package Drawing	Pins	SPQ	Length (mm)	Width (mm)	Height (mm)
SN74LVC07ADBR	SSOP	DB	14	2000	346.0	346.0	33.0
SN74LVC07ADGVR	TVSOP	DGV	14	2000	346.0	346.0	29.0
SN74LVC07ADR	SOIC	D	14	2500	346.0	346.0	33.0
SN74LVC07ADR	SOIC	D	14	2500	333.2	345.9	28.6
SN74LVC07ADT	SOIC	D	14	250	346.0	346.0	33.0
SN74LVC07ANSR	SO	NS	14	2000	346.0	346.0	33.0
SN74LVC07APWR	TSSOP	PW	14	2000	346.0	346.0	29.0
SN74LVC07APWR	TSSOP	PW	14	2000	364.0	364.0	27.0
SN74LVC07APWRG3	TSSOP	PW	14	2000	364.0	364.0	27.0
SN74LVC07APWT	TSSOP	PW	14	250	346.0	346.0	29.0
SN74LVC07ARGYR	VQFN	RGY	14	3000	346.0	346.0	29.0

DGV (R-PDSO-G**)

PLASTIC SMALL-OUTLINE

24 PINS SHOWN



- NOTES: A. All linear dimensions are in millimeters.
 B. This drawing is subject to change without notice.
 C. Body dimensions do not include mold flash or protrusion, not to exceed 0,15 per side.
 D. Falls within JEDEC: 24/48 Pins – MO-153
 14/16/20/56 Pins – MO-194

D (R-PDSO-G14)

PLASTIC SMALL OUTLINE

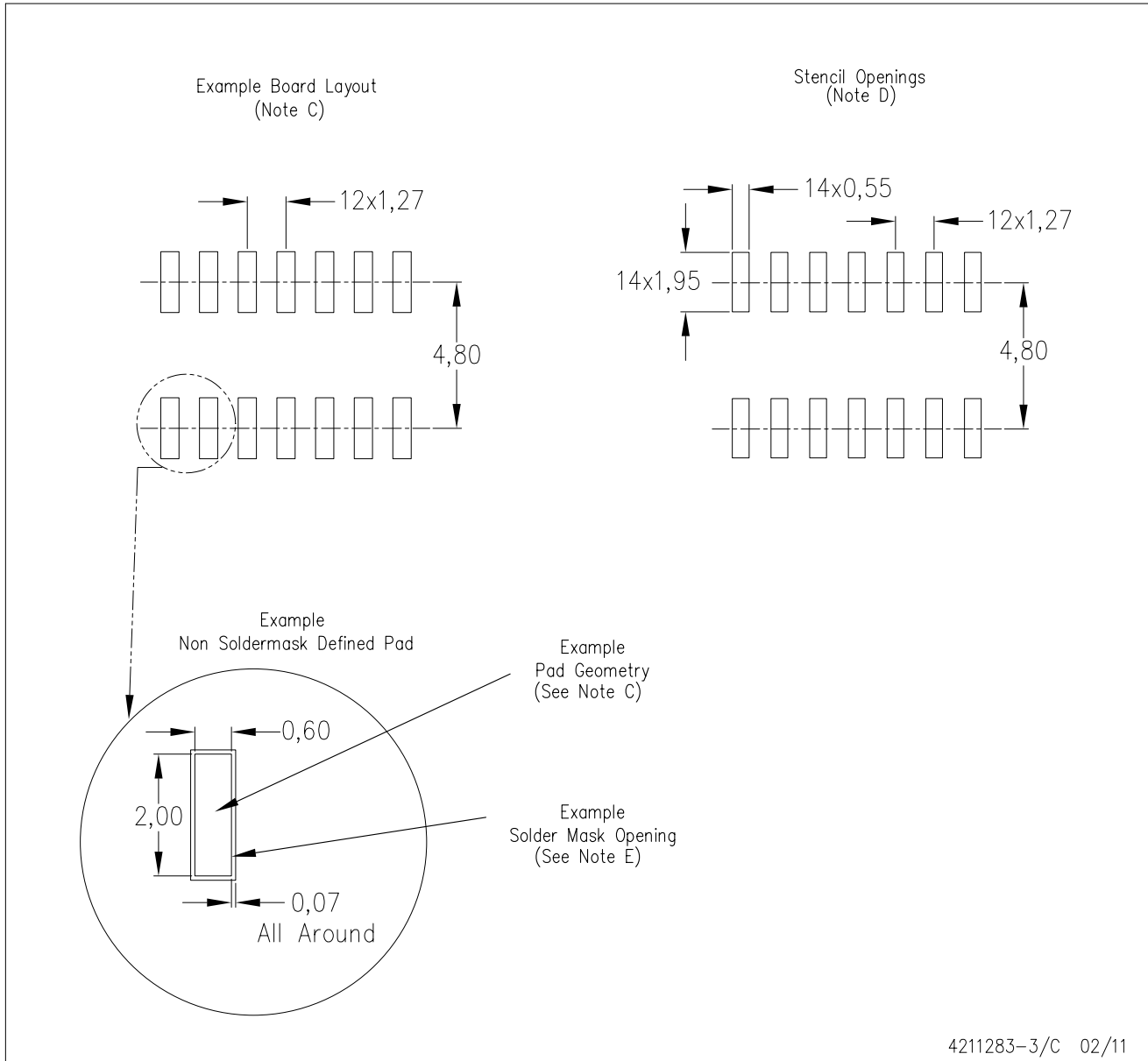

4211283-3/C 02/11



- NOTES:
- All linear dimensions are in millimeters.
 - This drawing is subject to change without notice.
 - Publication IPC-7351 is recommended for alternate designs.
 - Laser cutting apertures with trapezoidal walls and also rounding corners will offer better paste release. Customers should contact their board assembly site for stencil design recommendations. Refer to IPC-7525 for other stencil recommendations.
 - Customers should contact their board fabrication site for solder mask tolerances between and around signal pads.

PW (R-PDSO-G14)

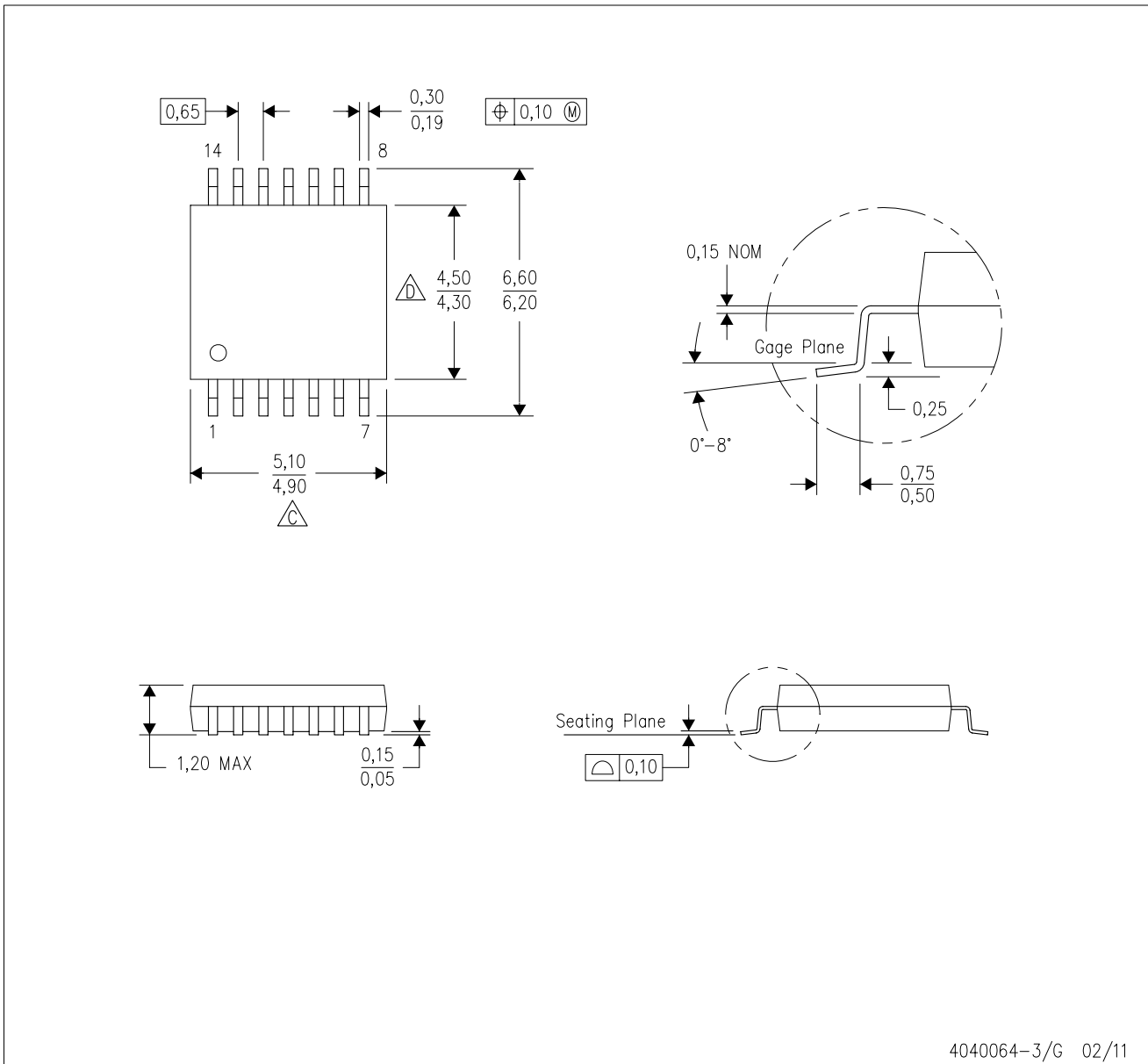
PLASTIC SMALL OUTLINE



4040064-3/G 02/11

- NOTES:
- A. All linear dimensions are in millimeters. Dimensioning and tolerancing per ASME Y14.5M-1994.
 - B. This drawing is subject to change without notice.
 -  Body length does not include mold flash, protrusions, or gate burrs. Mold flash, protrusions, or gate burrs shall not exceed 0,15 each side.
 -  Body width does not include interlead flash. Interlead flash shall not exceed 0,25 each side.
 - E. Falls within JEDEC MO-153

PW (R-PDSO-G14)

PLASTIC SMALL OUTLINE

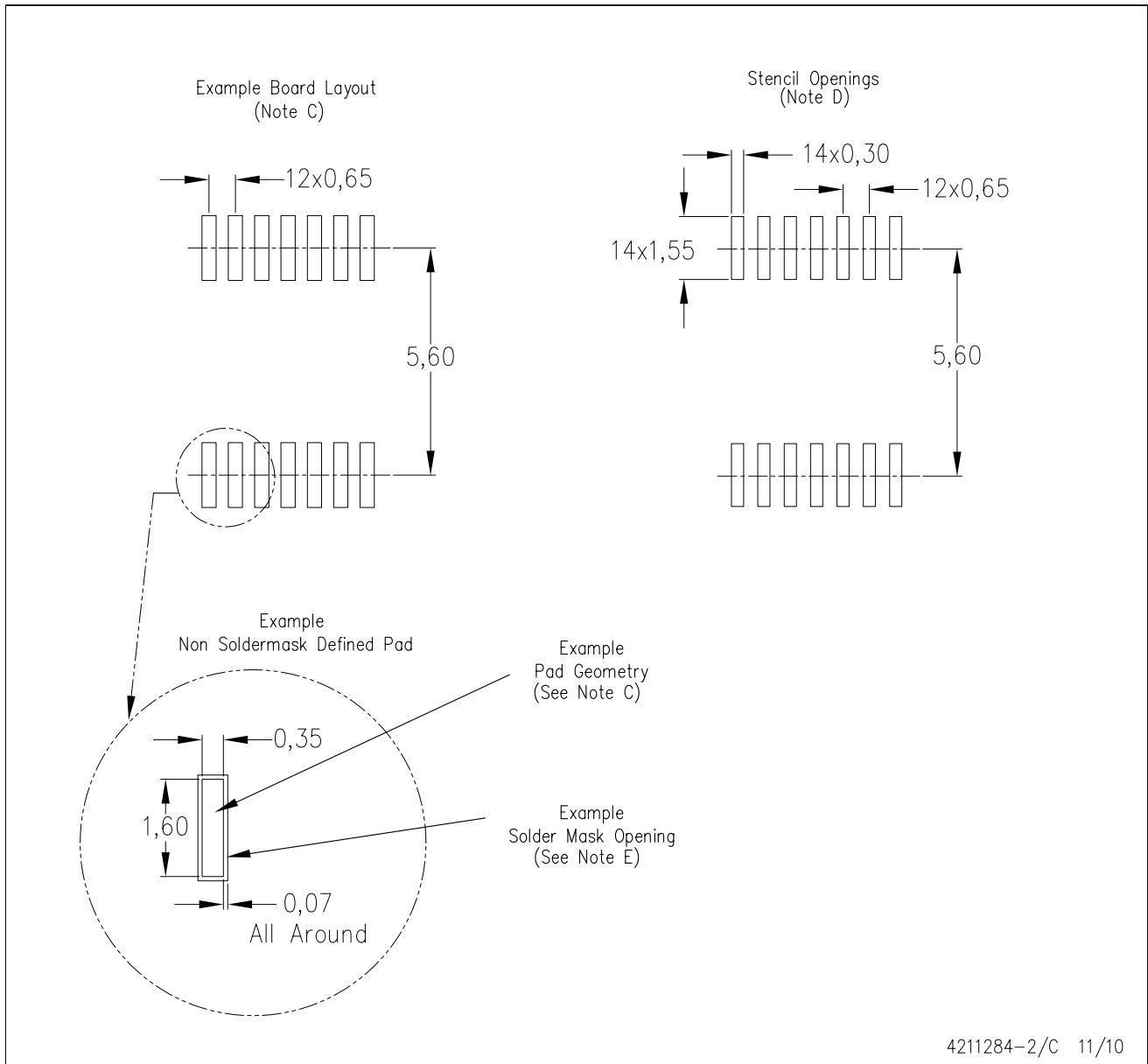



- NOTES:
- All linear dimensions are in millimeters.
 - This drawing is subject to change without notice.
 - Publication IPC-7351 is recommended for alternate designs.
 - Laser cutting apertures with trapezoidal walls and also rounding corners will offer better paste release. Customers should contact their board assembly site for stencil design recommendations. Refer to IPC-7525 for other stencil recommendations.
 - Customers should contact their board fabrication site for solder mask tolerances between and around signal pads.

RGY (S-PVQFN-N14)

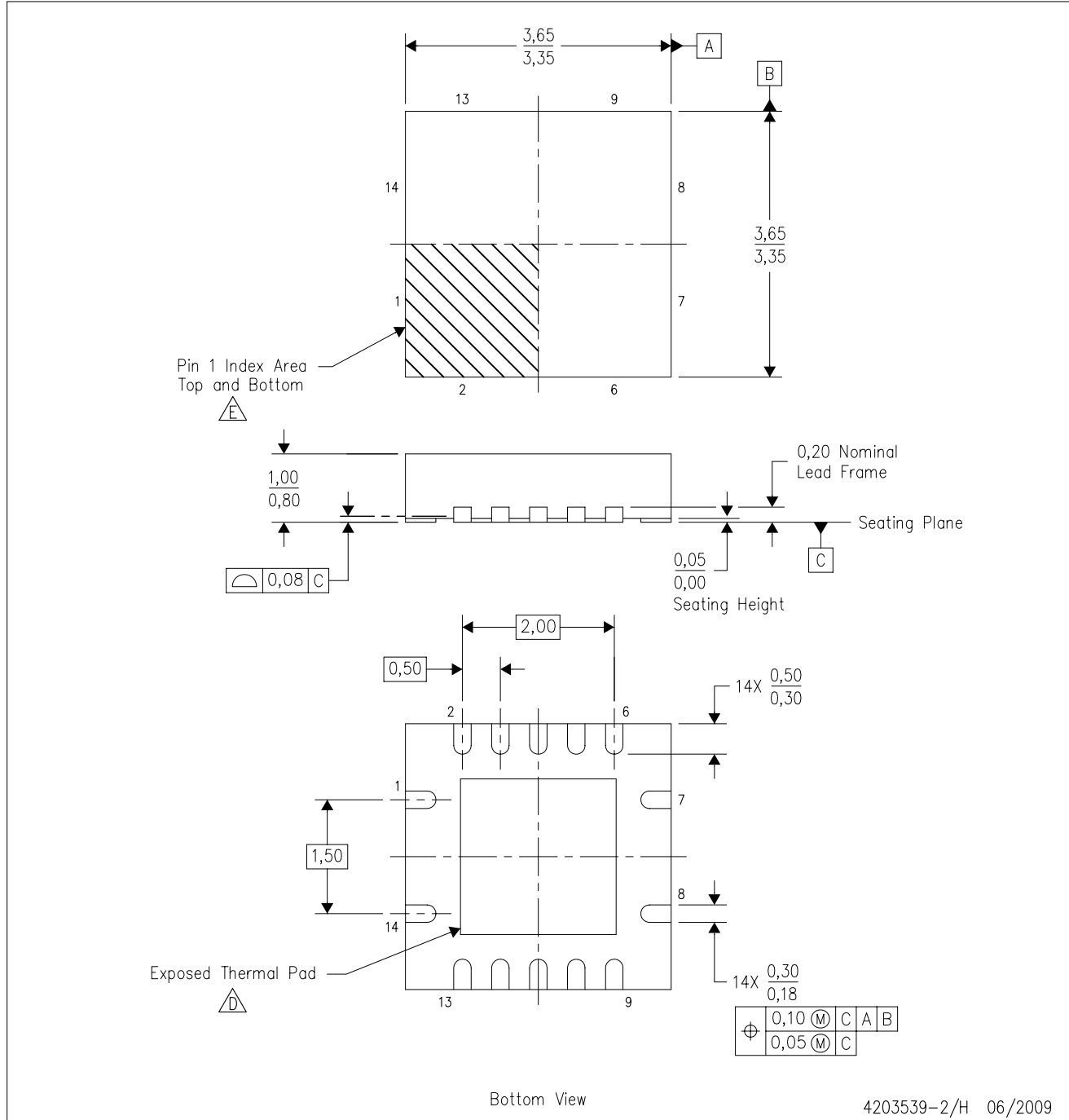
PLASTIC QUAD FLATPACK NO-LEAD



- NOTES:
- A. All linear dimensions are in millimeters. Dimensioning and tolerancing per ASME Y14.5M-1994.
 - B. This drawing is subject to change without notice.
 - C. QFN (Quad Flatpack No-Lead) package configuration.
 -  The package thermal pad must be soldered to the board for thermal and mechanical performance. See the Product Data Sheet for details regarding the exposed thermal pad dimensions.
 -  Pin 1 identifiers are located on both top and bottom of the package and within the zone indicated. The Pin 1 identifiers are either a molded, marked, or metal feature.
 - F. Package complies to JEDEC MO-241 variation BA.

RGY (S-PVQFN-N14)

PLASTIC QUAD FLATPACK NO-LEAD

THERMAL INFORMATION

This package incorporates an exposed thermal pad that is designed to be attached directly to an external heatsink. The thermal pad must be soldered directly to the printed circuit board (PCB). After soldering, the PCB can be used as a heatsink. In addition, through the use of thermal vias, the thermal pad can be attached directly to the appropriate copper plane shown in the electrical schematic for the device, or alternatively, can be attached to a special heatsink structure designed into the PCB. This design optimizes the heat transfer from the integrated circuit (IC).

For information on the Quad Flatpack No-Lead (QFN) package and its advantages, refer to Application Report, QFN/SON PCB Attachment, Texas Instruments Literature No. SLUA271. This document is available at www.ti.com.

The exposed thermal pad dimensions for this package are shown in the following illustration.

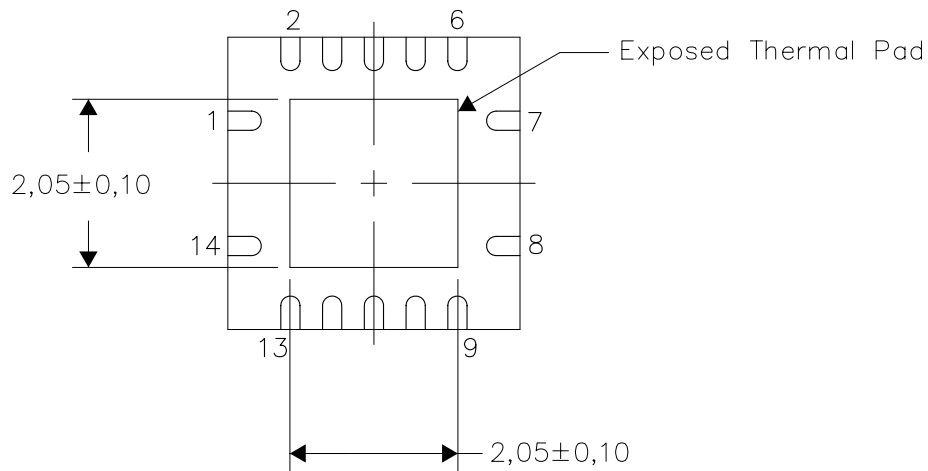

Bottom View

Exposed Thermal Pad Dimensions

4206353-2/M 02/11

NOTE: A. All linear dimensions are in millimeters

RGY (S-PVQFN-N14)

PLASTIC QUAD FLATPACK NO-LEAD

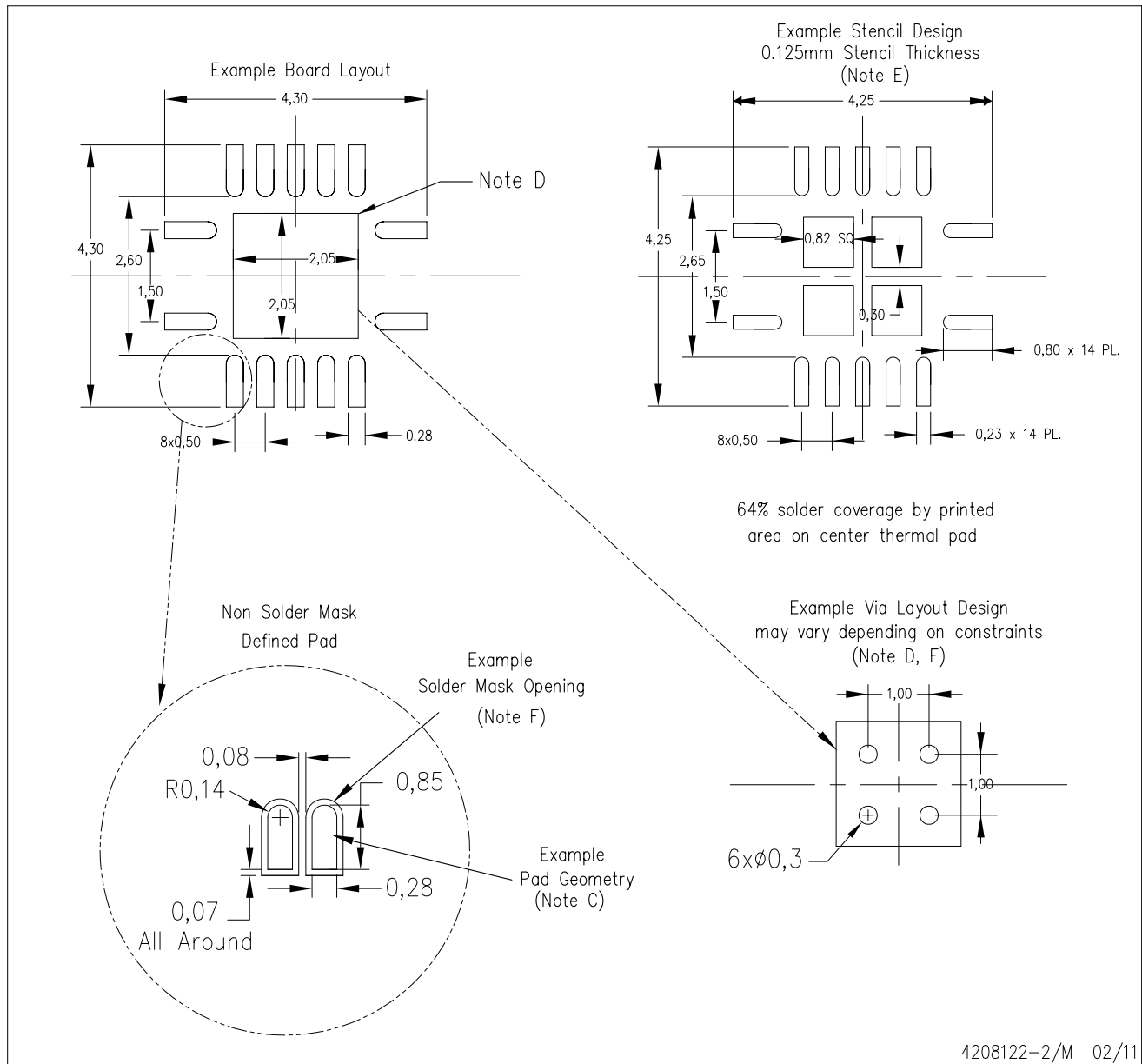

4208122-2/M 02/11

- NOTES:
- All linear dimensions are in millimeters.
 - This drawing is subject to change without notice.
 - Publication IPC-7351 is recommended for alternate designs.
 - This package is designed to be soldered to a thermal pad on the board. Refer to Application Note, Quad Flat-Pack QFN/SON PCB Attachment, Texas Instruments Literature No. SLUA271, and also the Product Data Sheets for specific thermal information, via requirements, and recommended board layout. These documents are available at www.ti.com <<http://www.ti.com>>.
 - Laser cutting apertures with trapezoidal walls and also rounding corners will offer better paste release. Customers should contact their board assembly site for stencil design recommendations. Refer to IPC 7525 for stencil design considerations.
 - Customers should contact their board fabrication site for minimum solder mask web tolerances between signal pads.

MECHANICAL DATA

NS (R-PDSO-G**)

PLASTIC SMALL-OUTLINE PACKAGE

14-PINS SHOWN



- NOTES:
- A. All linear dimensions are in millimeters.
 - B. This drawing is subject to change without notice.
 - C. Body dimensions do not include mold flash or protrusion, not to exceed 0,15.

DB (R-PDSO-G**)

PLASTIC SMALL-OUTLINE

28 PINS SHOWN



- NOTES: A. All linear dimensions are in millimeters.
 B. This drawing is subject to change without notice.
 C. Body dimensions do not include mold flash or protrusion not to exceed 0,15.
 D. Falls within JEDEC MO-150

IMPORTANT NOTICE

Texas Instruments Incorporated and its subsidiaries (TI) reserve the right to make corrections, modifications, enhancements, improvements, and other changes to its products and services at any time and to discontinue any product or service without notice. Customers should obtain the latest relevant information before placing orders and should verify that such information is current and complete. All products are sold subject to TI's terms and conditions of sale supplied at the time of order acknowledgment.

TI warrants performance of its hardware products to the specifications applicable at the time of sale in accordance with TI's standard warranty. Testing and other quality control techniques are used to the extent TI deems necessary to support this warranty. Except where mandated by government requirements, testing of all parameters of each product is not necessarily performed.

TI assumes no liability for applications assistance or customer product design. Customers are responsible for their products and applications using TI components. To minimize the risks associated with customer products and applications, customers should provide adequate design and operating safeguards.

TI does not warrant or represent that any license, either express or implied, is granted under any TI patent right, copyright, mask work right, or other TI intellectual property right relating to any combination, machine, or process in which TI products or services are used. Information published by TI regarding third-party products or services does not constitute a license from TI to use such products or services or a warranty or endorsement thereof. Use of such information may require a license from a third party under the patents or other intellectual property of the third party, or a license from TI under the patents or other intellectual property of TI.

Reproduction of TI information in TI data books or data sheets is permissible only if reproduction is without alteration and is accompanied by all associated warranties, conditions, limitations, and notices. Reproduction of this information with alteration is an unfair and deceptive business practice. TI is not responsible or liable for such altered documentation. Information of third parties may be subject to additional restrictions.

Resale of TI products or services with statements different from or beyond the parameters stated by TI for that product or service voids all express and any implied warranties for the associated TI product or service and is an unfair and deceptive business practice. TI is not responsible or liable for any such statements.

TI products are not authorized for use in safety-critical applications (such as life support) where a failure of the TI product would reasonably be expected to cause severe personal injury or death, unless officers of the parties have executed an agreement specifically governing such use. Buyers represent that they have all necessary expertise in the safety and regulatory ramifications of their applications, and acknowledge and agree that they are solely responsible for all legal, regulatory and safety-related requirements concerning their products and any use of TI products in such safety-critical applications, notwithstanding any applications-related information or support that may be provided by TI. Further, Buyers must fully indemnify TI and its representatives against any damages arising out of the use of TI products in such safety-critical applications.

TI products are neither designed nor intended for use in military/aerospace applications or environments unless the TI products are specifically designated by TI as military-grade or "enhanced plastic." Only products designated by TI as military-grade meet military specifications. Buyers acknowledge and agree that any such use of TI products which TI has not designated as military-grade is solely at the Buyer's risk, and that they are solely responsible for compliance with all legal and regulatory requirements in connection with such use.

TI products are neither designed nor intended for use in automotive applications or environments unless the specific TI products are designated by TI as compliant with ISO/TS 16949 requirements. Buyers acknowledge and agree that, if they use any non-designated products in automotive applications, TI will not be responsible for any failure to meet such requirements.

Following are URLs where you can obtain information on other Texas Instruments products and application solutions:

Products

Audio	www.ti.com/audio
Amplifiers	amplifier.ti.com
Data Converters	dataconverter.ti.com
DLP® Products	www.dlp.com
DSP	dsp.ti.com
Clocks and Timers	www.ti.com/clocks
Interface	interface.ti.com
Logic	logic.ti.com
Power Mgmt	power.ti.com
Microcontrollers	microcontroller.ti.com
RFID	www.ti-rfid.com
RF/IF and ZigBee® Solutions	www.ti.com/lprf

Applications

Communications and Telecom	www.ti.com/communications
Computers and Peripherals	www.ti.com/computers
Consumer Electronics	www.ti.com/consumer-apps
Energy and Lighting	www.ti.com/energy
Industrial	www.ti.com/industrial
Medical	www.ti.com/medical
Security	www.ti.com/security
Space, Avionics and Defense	www.ti.com/space-avionics-defense
Transportation and Automotive	www.ti.com/automotive
Video and Imaging	www.ti.com/video
Wireless	www.ti.com/wireless-apps

TI E2E Community Home Page

e2e.ti.com

Mailing Address: Texas Instruments, Post Office Box 655303, Dallas, Texas 75265
Copyright © 2011, Texas Instruments Incorporated