

# LMV341,LMV342,LMV344

*LMV341/LMV342/LMV344 Single with Shutdown/Dual/Quad General Purpose,  
2.7V,Rail-to-Rail Output, 125C, Operational Amplifiers*



Literature Number: SNOS990F

# LMV341/LMV342/LMV344

## Single with Shutdown/Dual/Quad General Purpose, 2.7V, Rail-to-Rail Output, 125°C, Operational Amplifiers

### General Description

The LMV341/LMV342/LMV344 are single, dual, and quad low voltage, low power Operational Amplifiers. They are designed specifically for low voltage portable applications. Other important product characteristics are low input bias current, rail-to-rail output, and wide temperature range.

The patented class AB turnaround stage significantly reduces the noise at higher frequencies, power consumption, and off-set voltage. The PMOS input stage provides the user with ultra-low input bias current of 20fA (typical) and high input impedance.

The industrial-plus temperature range of  $-40^{\circ}\text{C}$  to  $125^{\circ}\text{C}$  allows the LMV341/LMV342/LMV344 to accommodate a broad range of extended environment applications. LMV341 expands National Semiconductor's Silicon Dust™ amplifier portfolio offering enhancements in size, speed, and power savings. The LMV341/LMV342/LMV344 are guaranteed to operate over the voltage range of 2.7V to 5.5V and all have rail-to-rail output.

The LMV341 offers a shutdown pin that can be used to disable the device. Once in shutdown mode, the supply current is reduced to 45pA (typical). The LMV341/LMV342/LMV344 have 29nV Voltage Noise at 10KHz, 1MHz GBW, 1.0V/ $\mu\text{s}$  Slew Rate, 0.25mVos, and 0.1 $\mu\text{A}$  shutdown current (LMV341.)

The LMV341 is offered in the tiny 6-Pin SC70 package, the LMV342 in space saving 8-Pin MSOP and SOIC, and the LMV344 in 14-Pin TSSOP and SOIC. These small package amplifiers offer an ideal solution for applications requiring minimum PC board footprint. Applications with area con-

strained PC board requirements include portable electronics such as cellular handsets and PDAs.

### Features

(Typical 2.7V supply values; unless otherwise noted)

■ Guaranteed 2.7V and 5V specifications	
■ Input referred voltage noise (@ 10kHz)	29nV/ $\sqrt{\text{Hz}}$
■ Supply current (per amplifier)	100 $\mu\text{A}$
■ Gain bandwidth product	1.0MHz
■ Slew rate	1.0V/ $\mu\text{s}$
■ Shutdown Current (LMV341)	45pA
■ Turn-on time from shutdown (LMV341)	5 $\mu\text{s}$
■ Input bias current	20fA

### Applications

- Cordless/cellular phones
- Laptops
- PDAs
- PCMCIA/Audio
- Portable/battery-powered electronic equipment
- Supply current monitoring
- Battery monitoring
- Buffer
- Filter
- Driver

### Sample and Hold Circuit

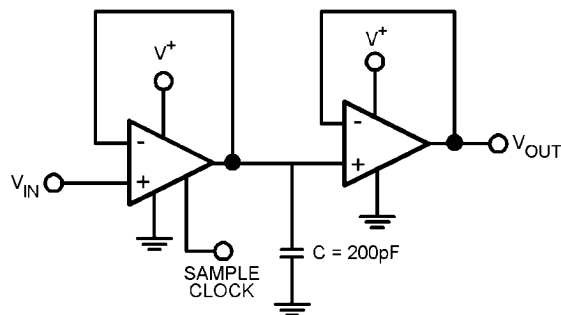

20030444

**Absolute Maximum Ratings** (Note 1)

If Military/Aerospace specified devices are required, please contact the National Semiconductor Sales Office/ Distributors for availability and specifications.

ESD Tolerance (Note 2)	
Machine Model	200V
Human Body Model	2000V
Differential Input Voltage	± Supply Voltage
Supply Voltage (V <sup>+</sup> -V <sup>-</sup> )	6.0V
Output Short Circuit to V <sup>+</sup>	(Note 3)
Output Short Circuit to V <sup>-</sup>	(Note 4)
Storage Temperature Range	-65°C to 150°C
Junction Temperature (Note 5)	150°C
Mounting Temperature	

Infrared or Convection Reflow (20 sec.)	235°C
Wave Soldering Lead Temp. (10 sec.)	260°C

**Operating Ratings** (Note 1)

Supply Voltage	2.7V to 5.5V
Temperature Range	-40°C to 125°C
Thermal Resistance ( $\theta_{JA}$ )	
6-Pin SC70	414°C/W
8-Pin SOIC	190°C/W
8-Pin MSOP	235°C/W
14-Pin TSSOP	155°C/W
14-Pin SOIC	145°C/W

**2.7V DC Electrical Characteristics** (Note 10)

Unless otherwise specified, all limits guaranteed for T<sub>J</sub> = 25°C, V<sup>+</sup> = 2.7V, V<sup>-</sup> = 0V, V<sub>CM</sub> = V<sup>+</sup>/2, V<sub>O</sub> = V<sup>+</sup>/2 and R<sub>L</sub> > 1M $\Omega$ . **Boldface** limits apply at the temperature extremes.

Symbol	Parameter	Conditions	Min (Note 7)	Typ (Note 6)	Max (Note 7)	Units	
V <sub>OS</sub>	Input Offset Voltage	LMV341		0.25	4 <b>4.5</b>	mV	
		LMV342/LMV344		0.55	5 <b>5.5</b>		
TCV <sub>OS</sub>	Input Offset Voltage Average Drift			1.7		$\mu$ V/°C	
I <sub>B</sub>	Input Bias Current			0.02	120 <b>250</b>	pA	
I <sub>OS</sub>	Input Offset Current			6.6		fA	
I <sub>S</sub>	Supply Current	Per Amplifier		100	170 <b>230</b>	$\mu$ A	
		Shutdown Mode, V <sub>SD</sub> = 0V (LMV341)		45pA	1 $\mu$ A <b>1.5<math>\mu</math>A</b>		
CMRR	Common Mode Rejection Ratio	0V ≤ V <sub>CM</sub> ≤ 1.7V	56	80		dB	
		0V ≤ V <sub>CM</sub> ≤ 1.6V	<b>50</b>				
PSRR	Power Supply Rejection Ratio	2.7V ≤ V <sup>+</sup> ≤ 5V	65 <b>60</b>	82		dB	
V <sub>CM</sub>	Input Common Mode Voltage	For CMRR ≥ 50dB	0	-0.2 to 1.9 (Range)	1.7	V	
A <sub>V</sub>	Large Signal Voltage Gain	R <sub>L</sub> = 10k $\Omega$ to 1.35V	78 <b>70</b>	113		dB	
		R <sub>L</sub> = 2k $\Omega$ to 1.35V	72 <b>64</b>	103			
V <sub>O</sub>	Output Swing	R <sub>L</sub> = 2k $\Omega$ to 1.35V		24	60 <b>95</b>	mV	
				60 <b>95</b>	26		
		R <sub>L</sub> = 10k $\Omega$ to 1.35V		5.0	30 <b>40</b>		
				30 <b>40</b>	5.3		

Symbol	Parameter	Conditions	Min (Note 7)	Typ (Note 6)	Max (Note 7)	Units
$I_O$	Output Short Circuit Current	Sourcing LMV341/LMV342	20	32		mA
		Sourcing LMV344	18	24		
		Sinking	15	24		
$t_{on}$	Turn-on Time from Shutdown	(LMV341)		5		$\mu$ s
$V_{SD}$	Shutdown Pin Voltage Range	ON Mode (LMV341)		1.7 to 2.7	2.4 to 2.7	V
		Shutdown Mode (LMV341)		0 to 1	0 to 0.8	

## 2.7V AC Electrical Characteristics (Note 10)

Unless otherwise specified, all limits guaranteed for  $T_J = 25^\circ\text{C}$ ,  $V^+ = 2.7\text{V}$ ,  $V^- = 0\text{V}$ ,  $V_{CM} = V^+/2$ ,  $V_O = V^+/2$  and  $R_L > 1\text{M}\Omega$ .

**Boldface** limits apply at the temperature extremes.

Symbol	Parameter	Conditions	Min (Note 7)	Typ (Note 6)	Max (Note 7)	Units
SR	Slew Rate	$R_L = 10\text{k}\Omega$ , (Note 9)		1.0		V/ $\mu$ s
GBW	Gain Bandwidth Product	$R_L = 100\text{k}\Omega$ , $C_L = 200\text{pF}$		1.0		MHz
$\phi_m$	Phase Margin	$R_L = 100\text{k}\Omega$		72		deg
$G_m$	Gain Margin	$R_L = 100\text{k}\Omega$		20		dB
$e_n$	Input-Referred Voltage Noise	$f = 1\text{kHz}$		40		$\text{nV}/\sqrt{\text{Hz}}$
$i_n$	Input-Referred Current Noise	$f = 1\text{kHz}$		0.001		$\text{pA}/\sqrt{\text{Hz}}$
THD	Total Harmonic Distortion	$f = 1\text{kHz}$ , $A_V = +1$ $R_L = 600\Omega$ , $V_{IN} = 1V_{PP}$		0.017		%

## 5V DC Electrical Characteristics (Note 10)

Unless otherwise specified, all limits guaranteed for  $T_J = 25^\circ\text{C}$ ,  $V^+ = 5\text{V}$ ,  $V^- = 0\text{V}$ ,  $V_{CM} = V^+/2$ ,  $V_O = V^+/2$  and  $R_L > 1\text{M}\Omega$ . **Boldface** limits apply at the temperature extremes.

Symbol	Parameter	Conditions	Min (Note 7)	Typ (Note 6)	Max (Note 7)	Units
$V_{OS}$	Input Offset Voltage	LMV341		0.025	4 <b>4.5</b>	mV
		LMV342/LMV344		0.70	5 <b>5.5</b>	
$TCV_{OS}$	Input Offset Voltage Average Drift			1.9		$\mu\text{V}/^\circ\text{C}$
$I_B$	Input Bias Current			0.02	200 <b>375</b>	pA
$I_{OS}$	Input Offset Current			6.6		fA
$I_S$	Supply Current	Per Amplifier		107	200 <b>260</b>	$\mu$ A
		Shutdown Mode, $V_{SD} = 0\text{V}$ (LMV341)		0.033	1 <b>1.5</b>	$\mu$ A
CMRR	Common Mode Rejection Ratio	$0\text{V} \leq V_{CM} \leq 4.0\text{V}$ $0\text{V} \leq V_{CM} \leq 3.9\text{V}$	56 <b>50</b>	86		dB
PSRR	Power Supply Rejection Ratio	$2.7\text{V} \leq V^+ \leq 5\text{V}$	65 <b>60</b>	82		dB
$V_{CM}$	Input Common Mode Voltage	For CMRR $\geq 50\text{dB}$	0	-0.2 to 4.2 (Range)	4	V

Symbol	Parameter	Conditions	Min (Note 7)	Typ (Note 6)	Max (Note 7)	Units
$A_V$	Large Signal Voltage Gain (Note 8)	$R_L = 10k\Omega$ to 2.5V	78 <b>70</b>	116		dB
		$R_L = 2k\Omega$ to 2.5V	72 <b>64</b>	107		
$V_O$	Output Swing	$R_L = 2k\Omega$ to 2.5V		32	60 <b>95</b>	mV
				60 <b>95</b>	34	
		$R_L = 10k\Omega$ to 2.5V		7	30 <b>40</b>	mV
				30 <b>40</b>	7	
$I_O$	Output Short Circuit Current	Sourcing	85	113		mA
		Sinking	50	75		
$t_{on}$	Turn-on Time from Shutdown	(LMV341)		5		$\mu s$
$V_{SD}$	Shutdown Pin Voltage Range	ON Mode (LMV341)		3.1 to 5	4.5 to 5.0	V
		Shutdown Mode (LMV341)		0 to 1	0 to 0.8	

### 5V AC Electrical Characteristics (Note 10)

Unless otherwise specified, all limits guaranteed for  $T_J = 25^\circ C$ ,  $V^+ = 5V$ ,  $V^- = 0V$ ,  $V_{CM} = V^+/2$ ,  $V_O = V^+/2$  and  $R_L > 1M\Omega$ . **Bold-face** limits apply at the temperature extremes.

Symbol	Parameter	Conditions	Min (Note 7)	Typ (Note 6)	Max (Note 7)	Units
SR	Slew Rate	$R_L = 10k\Omega$ , (Note 9)		1.0		V/ $\mu s$
GBW	Gain-Bandwidth Product	$R_L = 10k\Omega$ , $C_L = 200pF$		1.0		MHz
$\Phi_m$	Phase Margin	$R_L = 100k\Omega$		70		deg
$G_m$	Gain Margin	$R_L = 100k\Omega$		20		dB
$e_n$	Input-Referred Voltage Noise	$f = 1kHz$		39		$nV/\sqrt{Hz}$
$i_n$	Input-Referred Current Noise	$f = 1kHz$		0.001		$pA/\sqrt{Hz}$
THD	Total Harmonic Distortion	$f = 1kHz$ , $A_V = +1$ $R_L = 600\Omega$ , $V_{IN} = 1V_{PP}$		0.012		%

**Note 1:** Absolute Maximum Ratings indicate limits beyond which damage to the device may occur. Operating Ratings indicate conditions for which the device is intended to be functional, but specific performance is not guaranteed. For guaranteed specifications and the test conditions, see the Electrical Characteristics.

**Note 2:** Human Body Model, applicable std. MIL-STD-883, Method 3015.7. Machine Model, applicable std. JESD22-A115-A (ESD MM std. of JEDEC). Field-Induced Charge-Device Model, applicable std. JESD22-C101-C (ESD FICDM std. of JEDEC).

**Note 3:** Shorting output to  $V^+$  will adversely affect reliability.

**Note 4:** Shorting output to  $V^-$  will adversely affect reliability.

**Note 5:** The maximum power dissipation is a function of  $T_{J(MAX)}$ ,  $\theta_{JA}$ . The maximum allowable power dissipation at any ambient temperature is  $P_D = (T_{J(MAX)} - T_A) / \theta_{JA}$ . All numbers apply for packages soldered directly onto a PC Board.

**Note 6:** Typical values represent the most likely parametric norm as determined at the time of characterization. Actual typical values may vary over time and will also depend on the application and configuration. The typical values are not tested and are not guaranteed on shipped production material.

**Note 7:** All limits are guaranteed by testing or statistical analysis.

**Note 8:**  $R_L$  is connected to mid-supply. The output voltage is  $GND + 0.2V \leq V_O \leq V^+ - 0.2V$

**Note 9:** Connected as voltage follower with  $2V_{PP}$  step input. Number specified is the slower of the positive and negative slew rates.

**Note 10:** Electrical Table values apply only for factory testing conditions at the temperature indicated. Factory testing conditions result in very limited self-heating of the device such that  $T_J = T_A$ . No guarantee of parametric performance is indicated in the electrical tables under conditions of internal self heating where  $T_J > T_A$ .

## Connection Diagrams

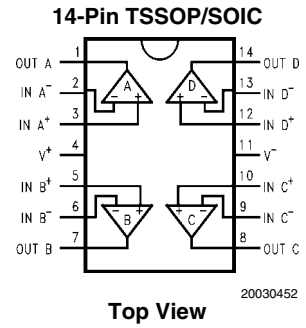
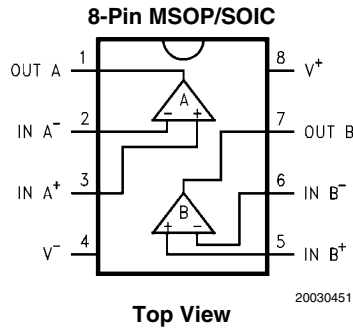
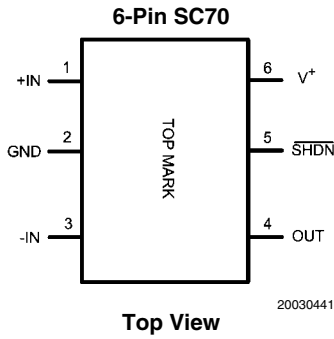

## Ordering Information

Package	Part Number	Package Marking	Transport Media	NSC Drawing
6-Pin SC70	LMV341MG	A78	1k Units Tape and Reel	MAA06A
	LMV341MGX		3k Units Tape and Reel	
8-Pin MSOP	LMV342MM	A82A	1k Units Tape and Reel	MUA08A
	LMV342MMX		3.5k Units Tape and Reel	
8-Pin SOIC	LMV342MA	LMV342MA	95 Units/Rail	M08A
	LMV342MAX		2.5k Units Tape and Reel	
14-Pin TSSOP	LMV344MT	LMV344MT	Rails	MTC14
	LMV344MTX		2.5k Units Tape and Reel	
14-Pin SOIC	LMV344MA	LMV344MA	55 Units/Rail	M14A
	LMV344MAX		2.5k Units Tape and Reel	

# Typical Performance Characteristics

Supply Current vs. Supply Voltage (LMV341)

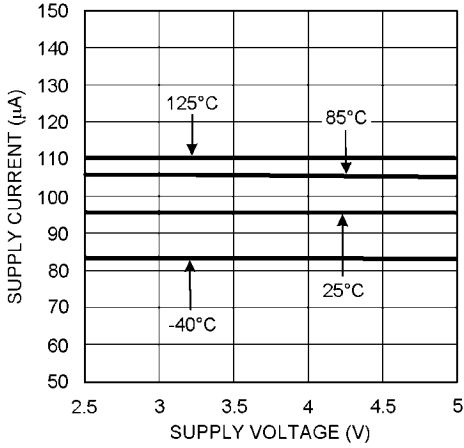

20030428

Input Current vs. Temperature

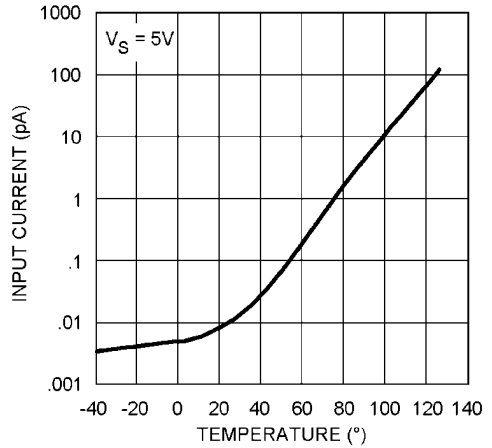

20030446

Output Voltage Swing vs. Supply Voltage

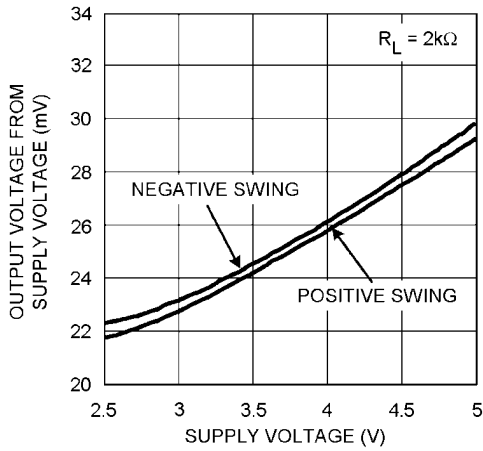

20030426

Output Voltage Swing vs. Supply Voltage

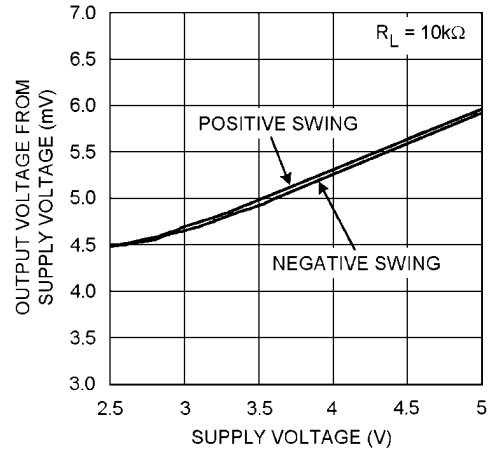

20030427

$I_{SOURCE}$  vs.  $V_{OUT}$

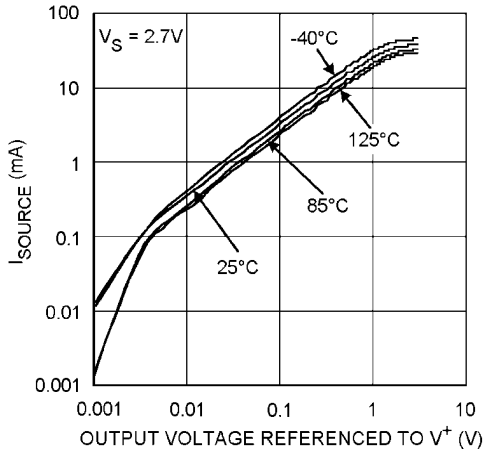

20030429

$I_{SOURCE}$  vs.  $V_{OUT}$

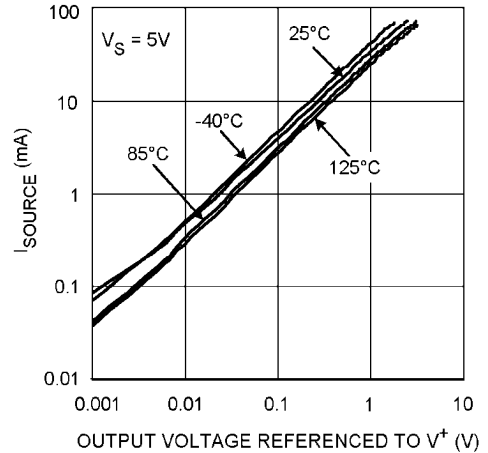

20030430

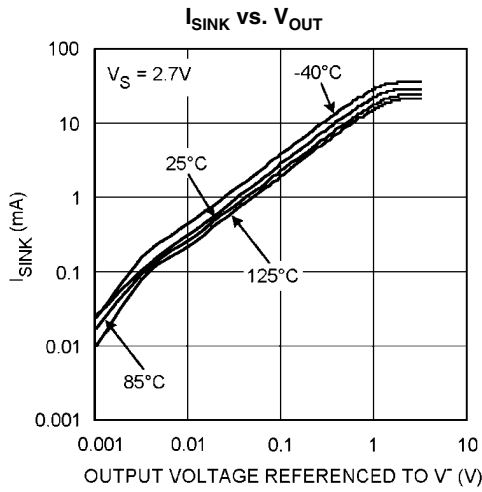

20030431

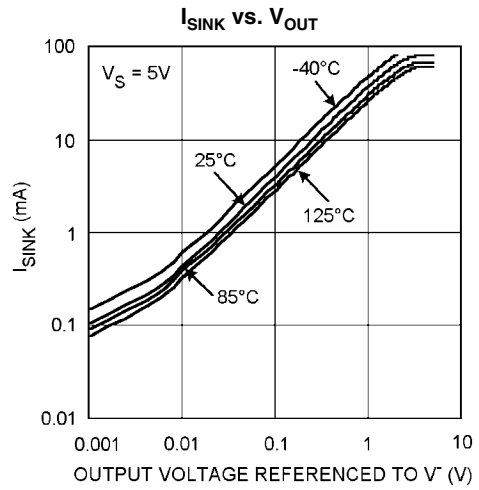

20030432

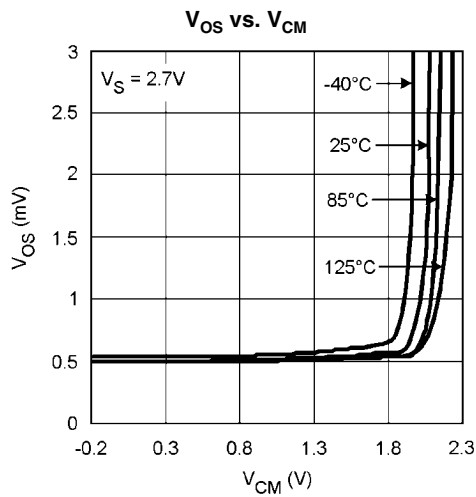

20030433

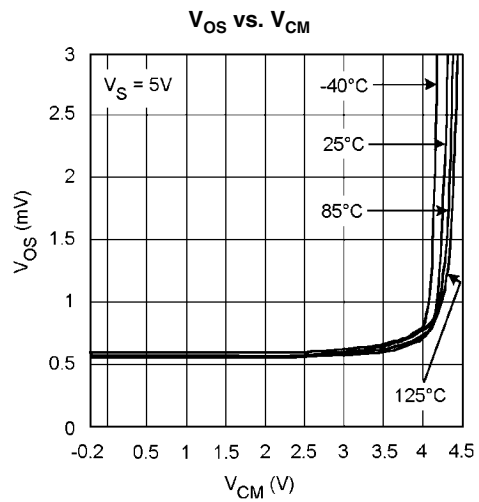

20030434

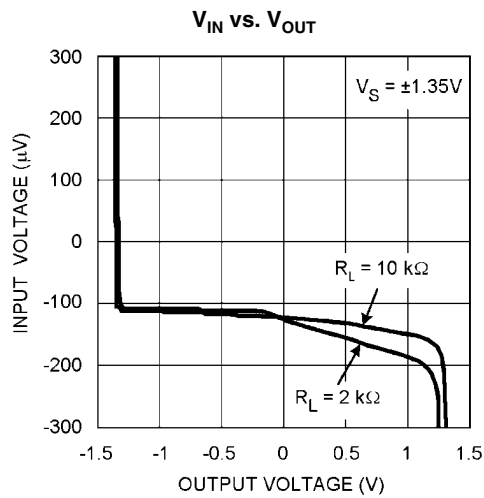

20030435

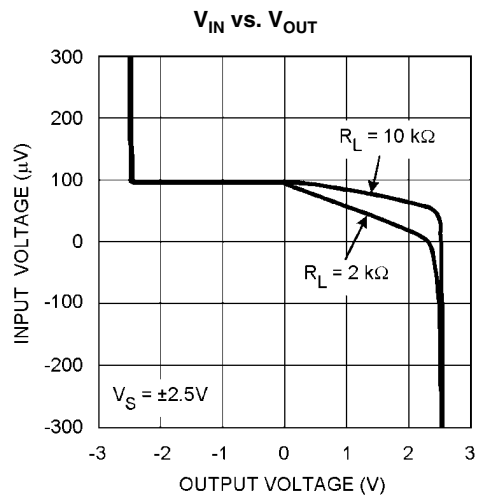

20030436



CMRR vs. Frequency

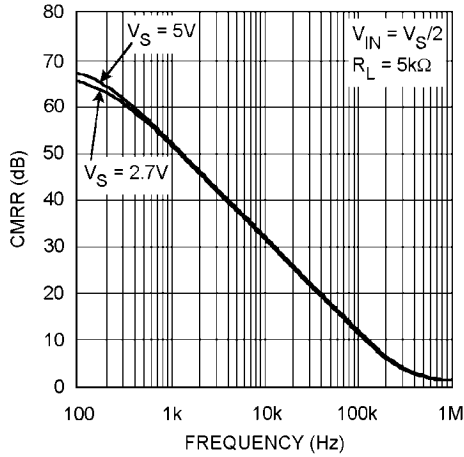

20030403

PSRR vs. Frequency

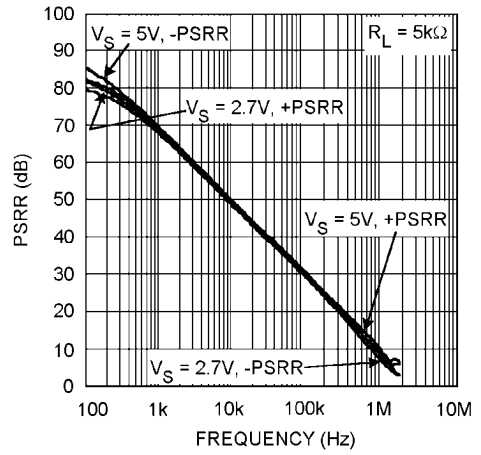

20030401

Input Voltage Noise vs. frequency

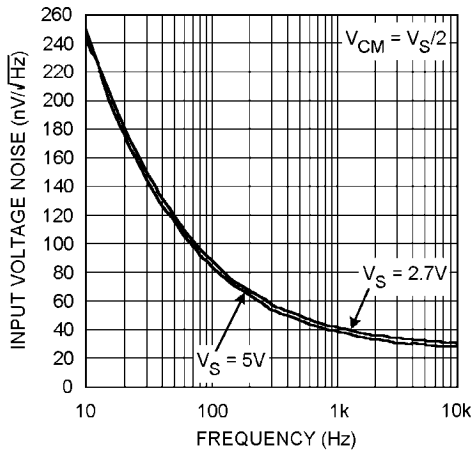

20030404

Slew Rate vs. V\_SUPPLY

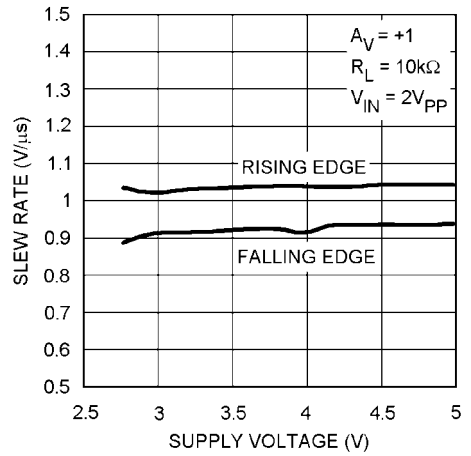

20030402

Slew Rate vs. Temperature

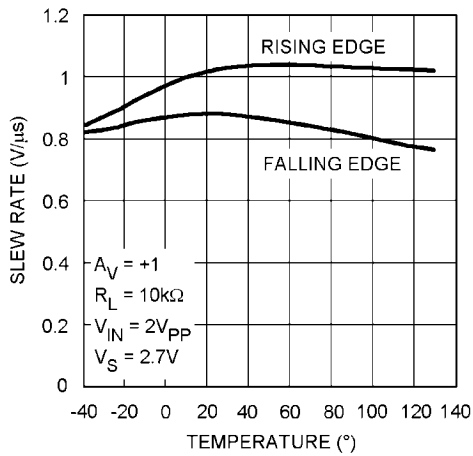

20030422

Slew Rate vs. Temperature

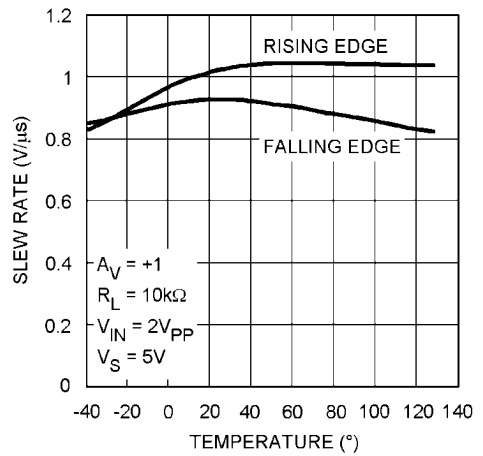

20030423

THD+N vs. Frequency

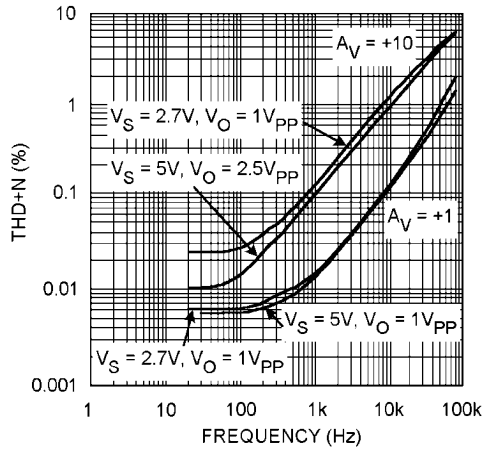

20030425

THD+N vs.  $V_{OUT}$

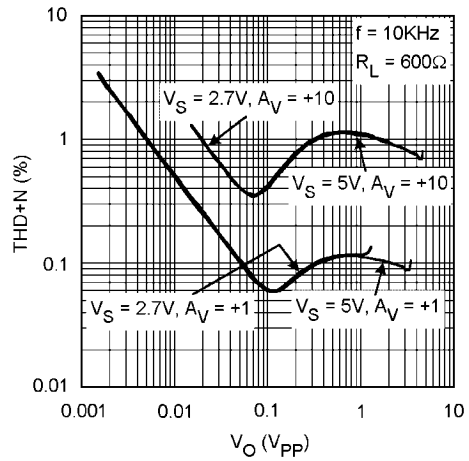

20030424

Open Loop Frequency Over Temperature

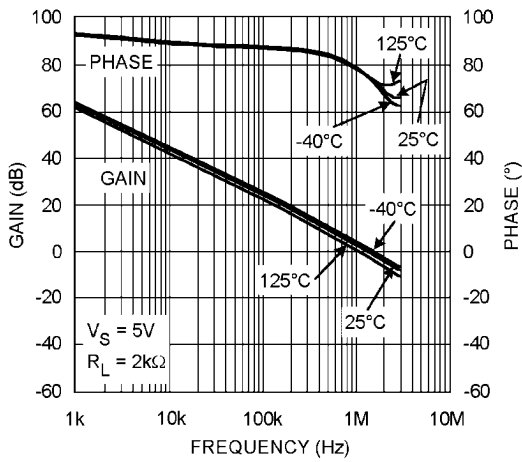

20030421

Open Loop Frequency Response

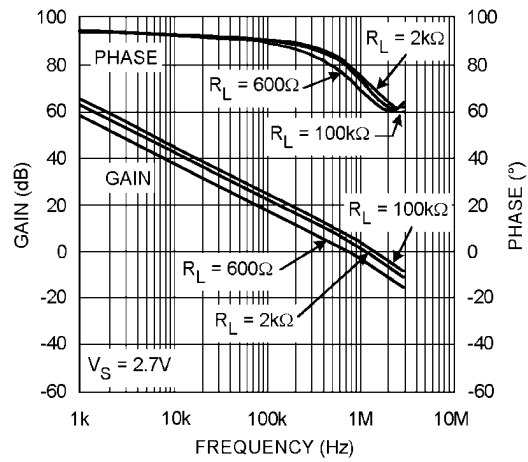

20030420

Open Loop Frequency Response

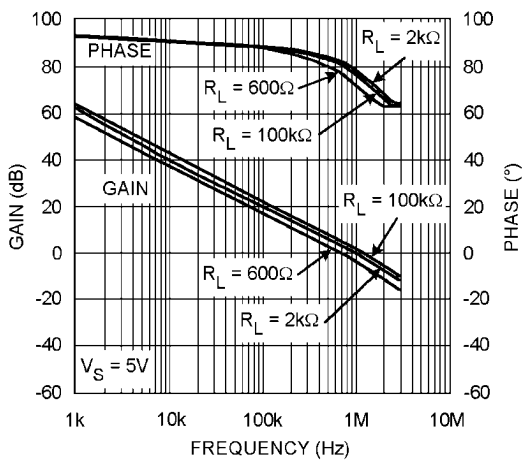

20030419

Gain and Phase vs.  $C_L$

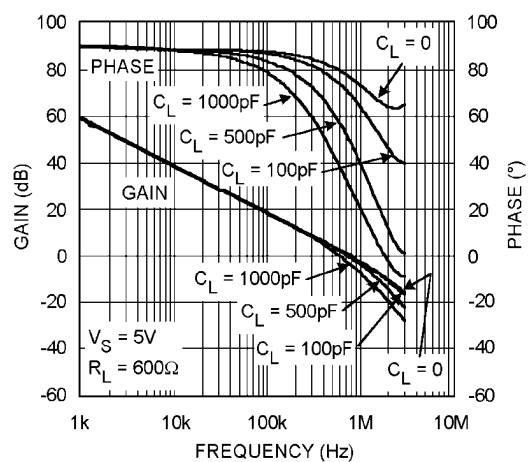

20030417

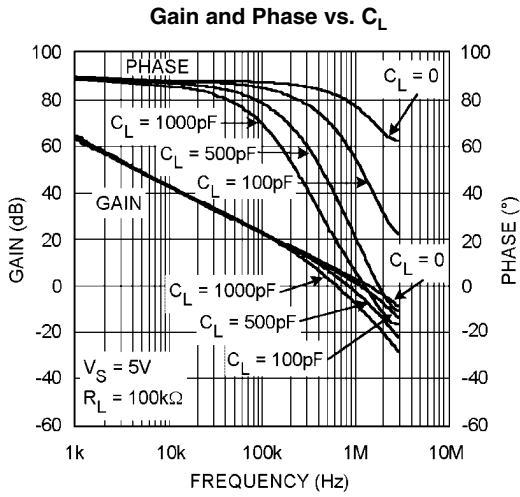

20030418

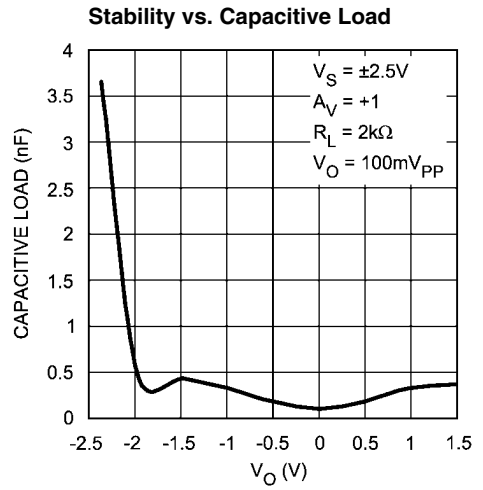

20030448

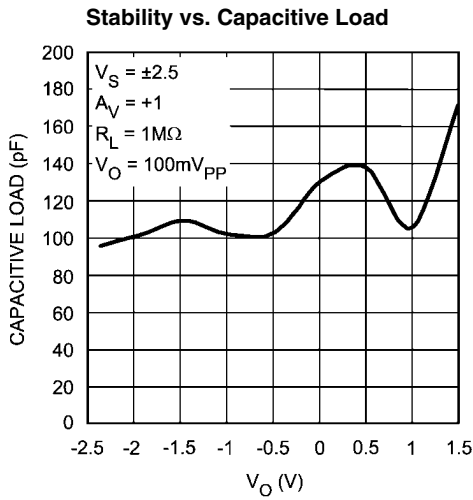

20030449

### Non-Inverting Small Signal Pulse Response

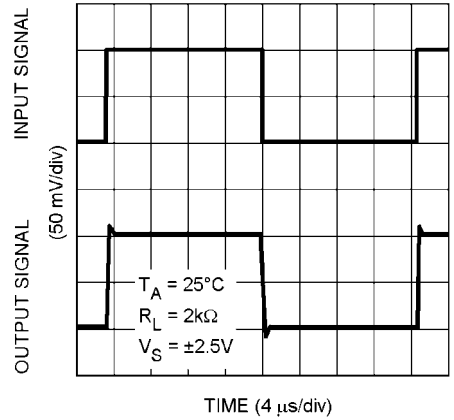

20030405

### Non-Inverting Large Signal Pulse Response

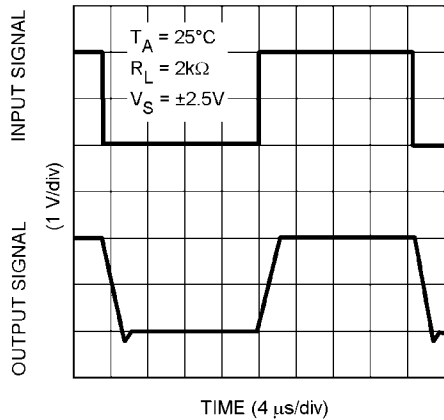

20030408

### Non-Inverting Small Signal Pulse Response

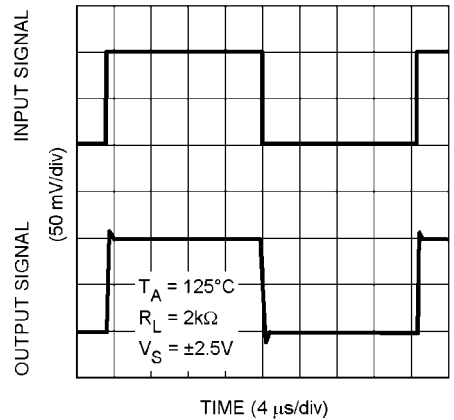

20030406

**Non-Inverting Large Signal Pulse Response**

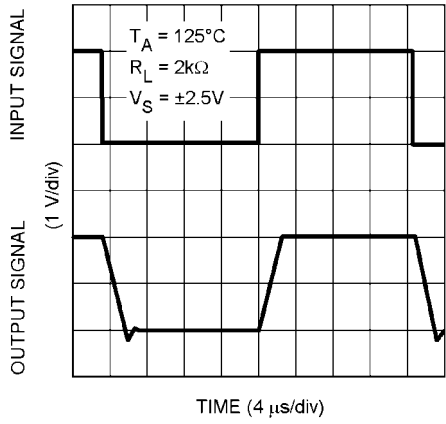

20030409

**Non-Inverting Small Signal Pulse Response**

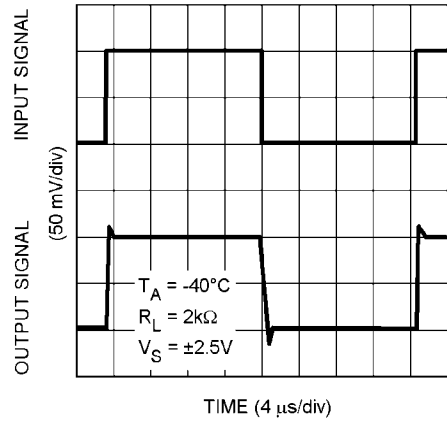

20030407

**Non-Inverting Large Signal Pulse Response**

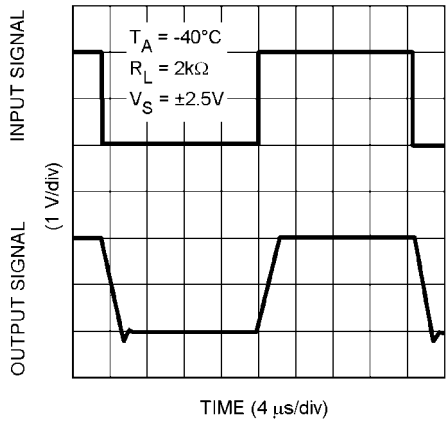

20030410

**Inverting Small Signal Pulse Response**

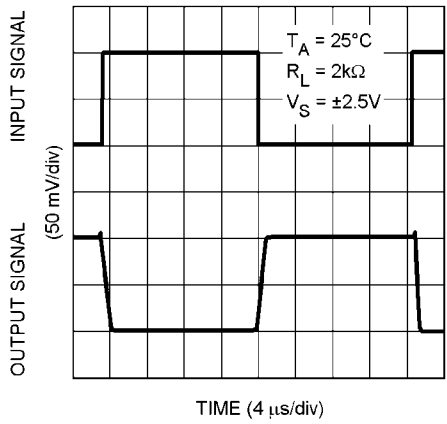

20030411

**Inverting Large Signal Pulse Response**

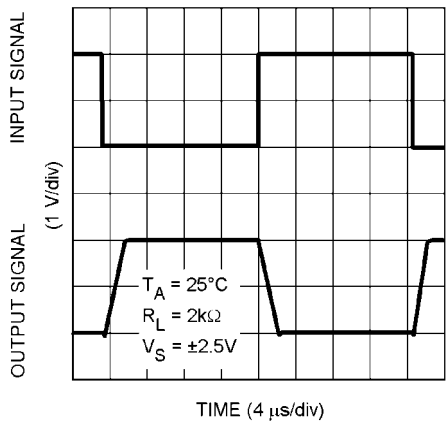

20030414

**Inverting Small Signal Pulse Response**

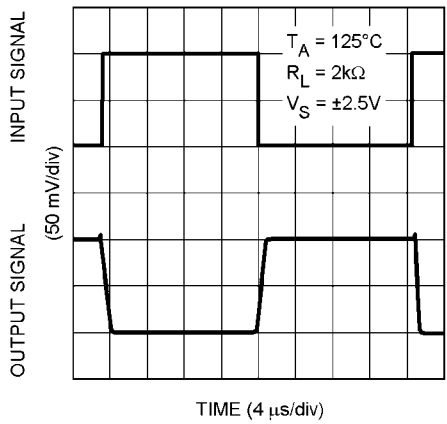

20030412

**Inverting Large Signal Pulse Response**

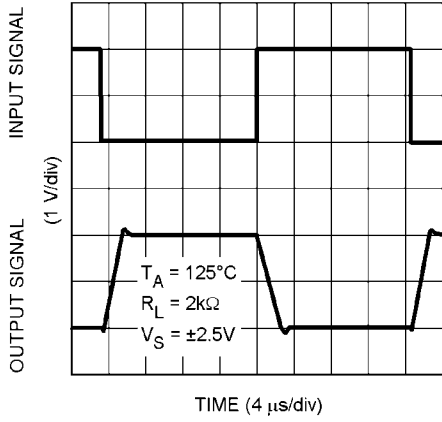

20030415

**Inverting Small Signal Pulse Response**

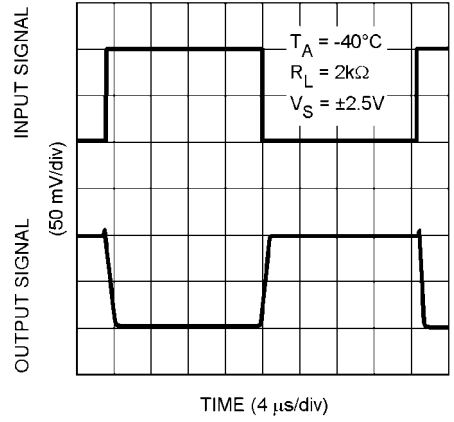

20030413

**Inverting Large Signal Pulse Response**

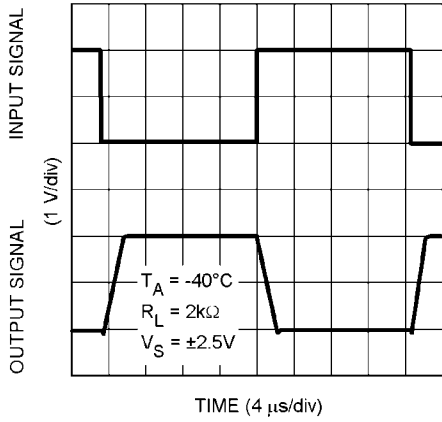

20030416

**Crosstalk Rejection vs. Frequency**

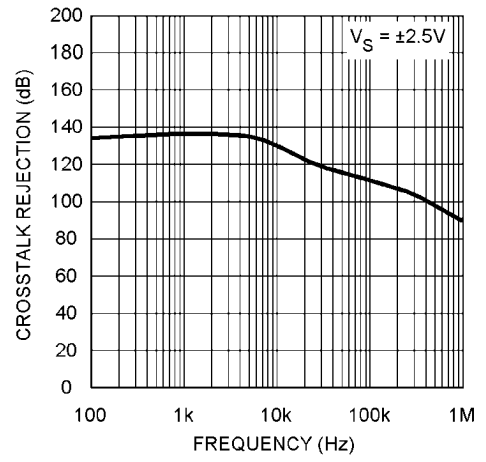

20030454

## Application Section

### LMV341/LMV342/LMV344

The LMV341/LMV342/LMV344 family of amplifiers features low voltage, low power, and rail-to-rail output operational amplifiers designed for low voltage portable applications. The family is designed using all CMOS technology. This results in an ultra low input bias current. The LMV341 has a shutdown option, which can be used in portable devices to increase battery life.

A simplified schematic of the LMV341/LMV342/LMV344 family of amplifiers is shown in *Figure 1*. The PMOS input differential pair allows the input to include ground. The output of this differential pair is connected to the Class AB turnaround stage. This Class AB turnaround has a lower quiescent current, compared to regular turnaround stages. This results in lower offset, noise, and power dissipation, while slew rate equals that of a conventional turnaround stage. The output of the Class AB turnaround stage provides gate voltage to the complementary common-source transistors at the output stage. These transistors enable the device to have rail-to-rail output.

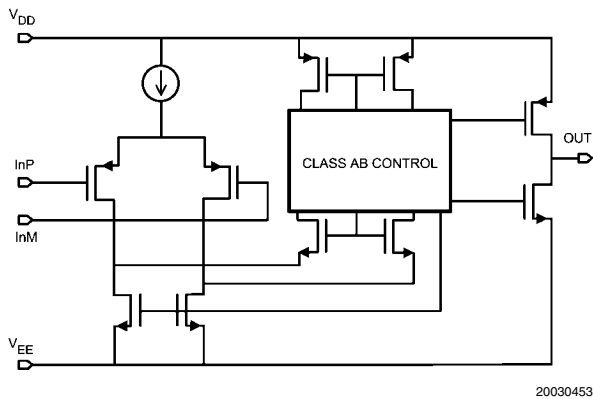

FIGURE 1. Simplified Schematic

### CLASS AB TURNAROUND STAGE AMPLIFIER

This patented folded cascode stage has a combined class AB amplifier stage, which replaces the conventional folded cascode stage. Therefore, the class AB folded cascode stage runs at a much lower quiescent current compared to conventional folded cascode stages. This results in significantly smaller offset and noise contributions. The reduced offset and noise contributions in turn reduce the offset voltage level and the voltage noise level at the input of the LMV341/LMV342/LMV344. Also the lower quiescent current results in a high open-loop gain for the amplifier. The lower quiescent current does not affect the slew rate of the amplifier nor its ability to handle the total current swing coming from the input stage.

The input voltage noise of the device at low frequencies, below 1kHz, is slightly higher than devices with a BJT input stage; However the PMOS input stage results in a much lower input bias current and the input voltage noise drops at frequencies above 1kHz.

### SAMPLE AND HOLD CIRCUIT

The lower input bias current of the LMV341 results in a very high input impedance. The output impedance when the device is in shutdown mode is quite high. These high impedances, along with the ability of the shutdown pin to be derived from a separate power source, make LMV341 a good choice for sample and hold circuits. The sample clock should be connected to the shutdown pin of the amplifier to rapidly turn the device on or off.

*Figure 2* shows the schematic of a simple sample and hold circuit. When the sample clock is high the first amplifier is in normal operation mode and the second amplifier acts as a buffer. The capacitor, which appears as a load on the first amplifier, will be charging at this time. The voltage across the capacitor is that of the non-inverting input of the first amplifier since it is connected as a voltage-follower. When the sample clock is low the first amplifier is shut off, bringing the output impedance to a high value. The high impedance of this output, along with the very high impedance on the input of the second amplifier, prevents the capacitor from discharging. There is very little voltage droop while the first amplifier is in shutdown mode. The second amplifier, which is still in normal operation mode and is connected as a voltage follower, also provides the voltage sampled on the capacitor at its output.

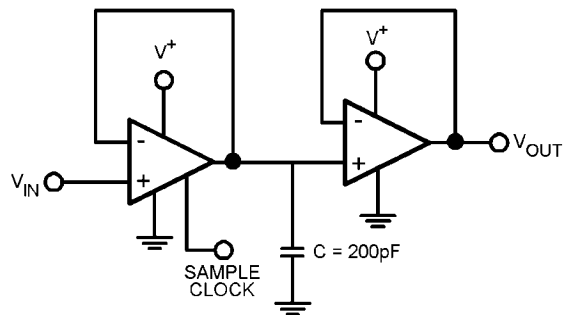

FIGURE 2. Sample and Hold Circuit

### SHUTDOWN FEATURE

The LMV341 is capable of being turned off in order to conserve power and increase battery life in portable devices. Once in shutdown mode the supply current is drastically reduced, 1 $\mu$ A maximum, and the output will be "tri-stated."

The device will be disabled when the shutdown pin voltage is pulled low. The shutdown pin should never be left unconnected. Leaving the pin floating will result in an undefined operation mode and the device may oscillate between shutdown and active modes.

The LMV341 typically turns on 2.8 $\mu$ s after the shutdown voltage is pulled high. The device turns off in less than 400ns after shutdown voltage is pulled low. *Figure 3* and *Figure 4* show the turn-on and turn-off time of the LMV341, respectively. In order to reduce the effect of the capacitance added to the circuit by the scope probe, in the turn-off time circuit a resistive load of 600 $\Omega$  is added. *Figure 5* and *Figure 6* show the test circuits used to obtain the two plots.

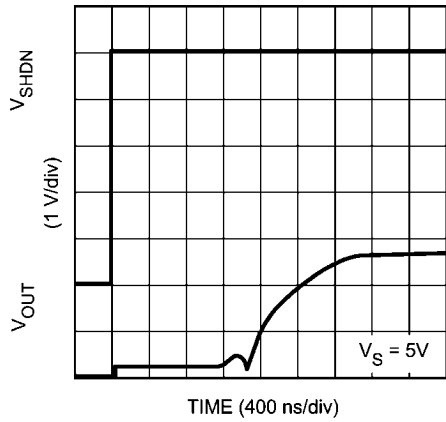

FIGURE 3. Turn-on Time

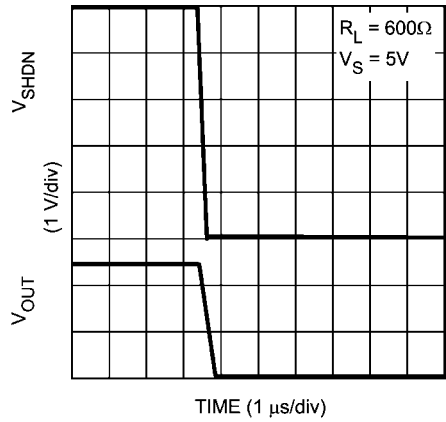

FIGURE 4. Turn-off Time

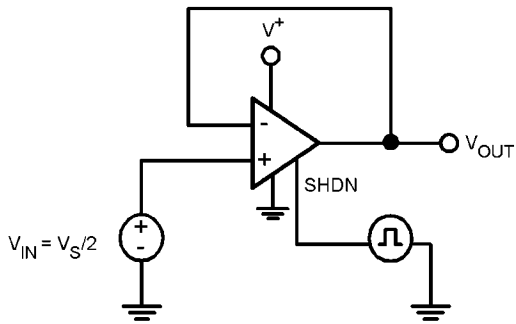

FIGURE 5. Turn-on Time

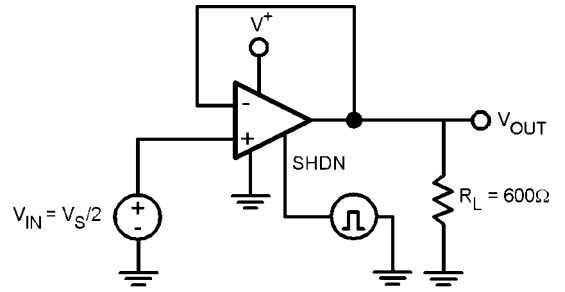

FIGURE 6. Turn-off Time

**LOW INPUT BIAS CURRENT**

The LMV341/LMV342/LMV344 Amplifiers have a PMOS input stage. As a result, they will have a much lower input bias current than devices with BJT input stages. This feature makes these devices ideal for sensor circuits. A typical curve of the input bias current of the LMV341 is shown in Figure 7.

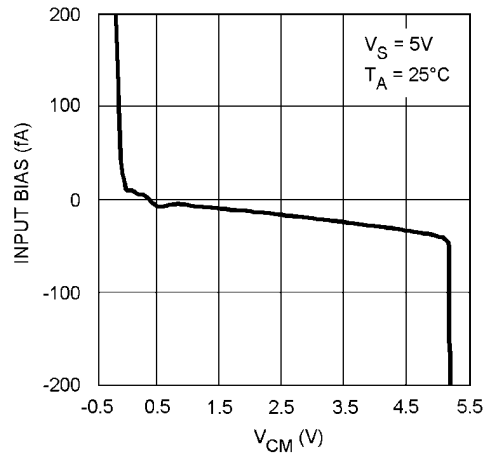
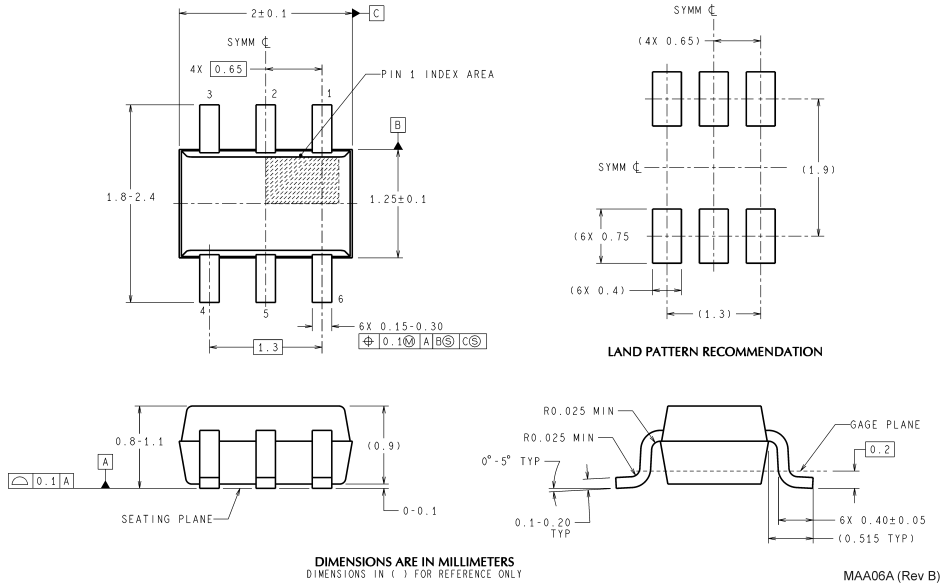
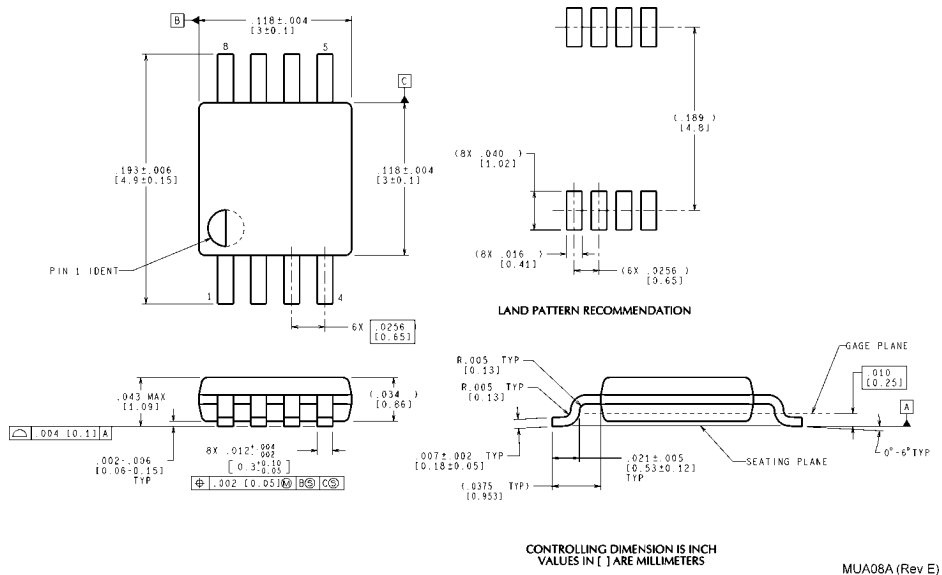

FIGURE 7. Input Bias Current vs.  $V_{CM}$

**Physical Dimensions** inches (millimeters) unless otherwise noted



**6-Pin SC70**  
**NS Package Number MAA06A**



**8-Pin MSOP**  
**NS Package Number MUA08A**



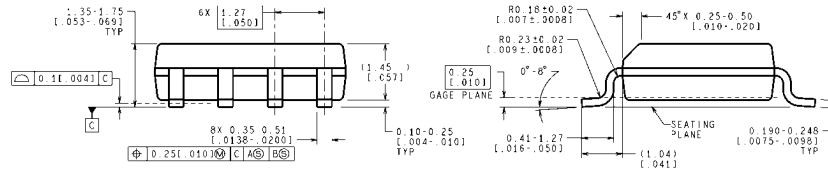
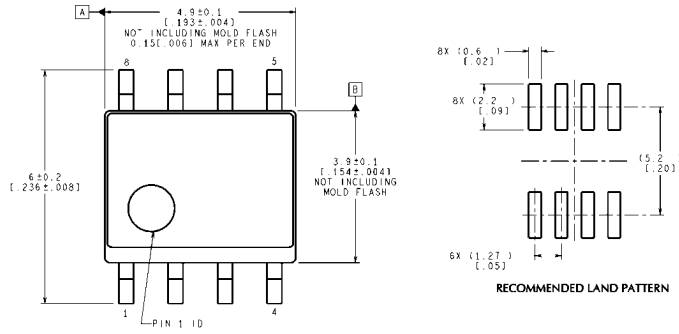

CONTROLLING DIMENSION IS MILLIMETER  
 VALUES IN [ ] ARE INCHES  
 DIMENSIONS IN ( ) FOR REFERENCE ONLY

M08A (Rev L)

**8-Pin SOIC**  
**NS Package Number M08A**

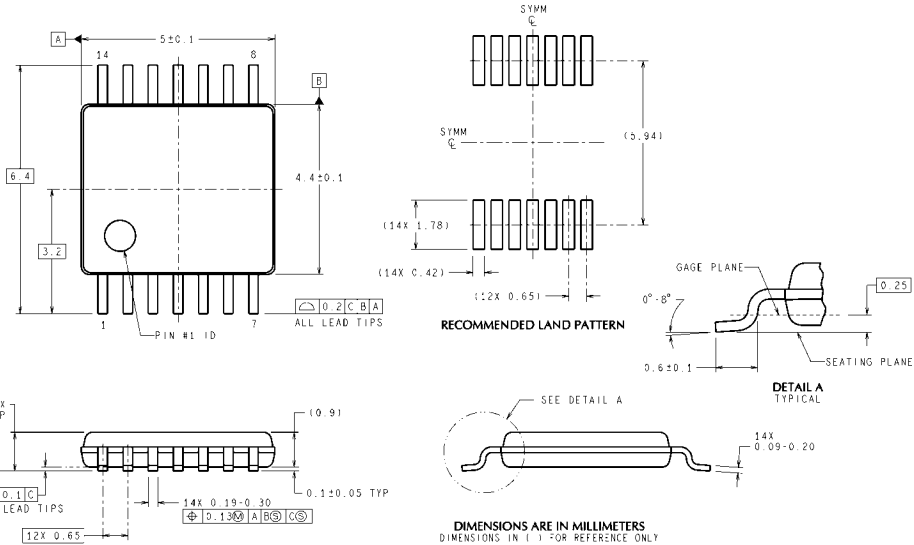

DIMENSIONS ARE IN MILLIMETERS  
 DIMENSIONS IN ( ) FOR REFERENCE ONLY

MTC14 (Rev D)

**14-Pin TSSOP**  
**NS Package Number MTC14**

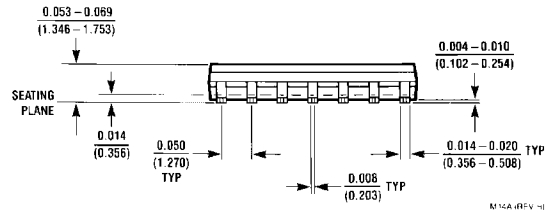
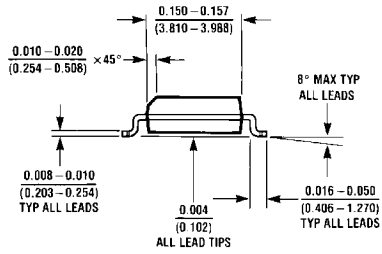
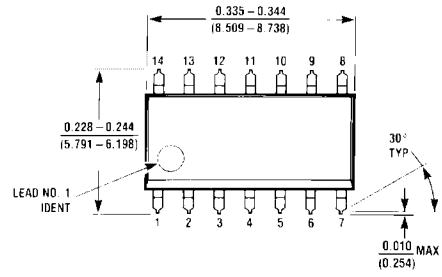

14-Pin SOIC  
NS Package Number M14A

## Notes

For more National Semiconductor product information and proven design tools, visit the following Web sites at:

Products		Design Support	
Amplifiers	<a href="http://www.national.com/amplifiers">www.national.com/amplifiers</a>	WEBENCH	<a href="http://www.national.com/webench">www.national.com/webench</a>
Audio	<a href="http://www.national.com/audio">www.national.com/audio</a>	Analog University	<a href="http://www.national.com/AU">www.national.com/AU</a>
Clock Conditioners	<a href="http://www.national.com/timing">www.national.com/timing</a>	App Notes	<a href="http://www.national.com/appnotes">www.national.com/appnotes</a>
Data Converters	<a href="http://www.national.com/adc">www.national.com/adc</a>	Distributors	<a href="http://www.national.com/contacts">www.national.com/contacts</a>
Displays	<a href="http://www.national.com/displays">www.national.com/displays</a>	Green Compliance	<a href="http://www.national.com/quality/green">www.national.com/quality/green</a>
Ethernet	<a href="http://www.national.com/ethernet">www.national.com/ethernet</a>	Packaging	<a href="http://www.national.com/packaging">www.national.com/packaging</a>
Interface	<a href="http://www.national.com/interface">www.national.com/interface</a>	Quality and Reliability	<a href="http://www.national.com/quality">www.national.com/quality</a>
LVDS	<a href="http://www.national.com/lvds">www.national.com/lvds</a>	Reference Designs	<a href="http://www.national.com/refdesigns">www.national.com/refdesigns</a>
Power Management	<a href="http://www.national.com/power">www.national.com/power</a>	Feedback	<a href="http://www.national.com/feedback">www.national.com/feedback</a>
Switching Regulators	<a href="http://www.national.com/switchers">www.national.com/switchers</a>		
LDOs	<a href="http://www.national.com/lido">www.national.com/lido</a>		
LED Lighting	<a href="http://www.national.com/led">www.national.com/led</a>		
PowerWise	<a href="http://www.national.com/powerwise">www.national.com/powerwise</a>		
Serial Digital Interface (SDI)	<a href="http://www.national.com/sdi">www.national.com/sdi</a>		
Temperature Sensors	<a href="http://www.national.com/tempsensors">www.national.com/tempsensors</a>		
Wireless (PLL/VCO)	<a href="http://www.national.com/wireless">www.national.com/wireless</a>		

THE CONTENTS OF THIS DOCUMENT ARE PROVIDED IN CONNECTION WITH NATIONAL SEMICONDUCTOR CORPORATION ("NATIONAL") PRODUCTS. NATIONAL MAKES NO REPRESENTATIONS OR WARRANTIES WITH RESPECT TO THE ACCURACY OR COMPLETENESS OF THE CONTENTS OF THIS PUBLICATION AND RESERVES THE RIGHT TO MAKE CHANGES TO SPECIFICATIONS AND PRODUCT DESCRIPTIONS AT ANY TIME WITHOUT NOTICE. NO LICENSE, WHETHER EXPRESS, IMPLIED, ARISING BY ESTOPPEL OR OTHERWISE, TO ANY INTELLECTUAL PROPERTY RIGHTS IS GRANTED BY THIS DOCUMENT.

TESTING AND OTHER QUALITY CONTROLS ARE USED TO THE EXTENT NATIONAL DEEMS NECESSARY TO SUPPORT NATIONAL'S PRODUCT WARRANTY. EXCEPT WHERE MANDATED BY GOVERNMENT REQUIREMENTS, TESTING OF ALL PARAMETERS OF EACH PRODUCT IS NOT NECESSARILY PERFORMED. NATIONAL ASSUMES NO LIABILITY FOR APPLICATIONS ASSISTANCE OR BUYER PRODUCT DESIGN. BUYERS ARE RESPONSIBLE FOR THEIR PRODUCTS AND APPLICATIONS USING NATIONAL COMPONENTS. PRIOR TO USING OR DISTRIBUTING ANY PRODUCTS THAT INCLUDE NATIONAL COMPONENTS, BUYERS SHOULD PROVIDE ADEQUATE DESIGN, TESTING AND OPERATING SAFEGUARDS.

EXCEPT AS PROVIDED IN NATIONAL'S TERMS AND CONDITIONS OF SALE FOR SUCH PRODUCTS, NATIONAL ASSUMES NO LIABILITY WHATSOEVER, AND NATIONAL DISCLAIMS ANY EXPRESS OR IMPLIED WARRANTY RELATING TO THE SALE AND/OR USE OF NATIONAL PRODUCTS INCLUDING LIABILITY OR WARRANTIES RELATING TO FITNESS FOR A PARTICULAR PURPOSE, MERCHANTABILITY, OR INFRINGEMENT OF ANY PATENT, COPYRIGHT OR OTHER INTELLECTUAL PROPERTY RIGHT.

### LIFE SUPPORT POLICY

**NATIONAL'S PRODUCTS ARE NOT AUTHORIZED FOR USE AS CRITICAL COMPONENTS IN LIFE SUPPORT DEVICES OR SYSTEMS WITHOUT THE EXPRESS PRIOR WRITTEN APPROVAL OF THE CHIEF EXECUTIVE OFFICER AND GENERAL COUNSEL OF NATIONAL SEMICONDUCTOR CORPORATION.** As used herein:

Life support devices or systems are devices which (a) are intended for surgical implant into the body, or (b) support or sustain life and whose failure to perform when properly used in accordance with instructions for use provided in the labeling can be reasonably expected to result in a significant injury to the user. A critical component is any component in a life support device or system whose failure to perform can be reasonably expected to cause the failure of the life support device or system or to affect its safety or effectiveness.

National Semiconductor and the National Semiconductor logo are registered trademarks of National Semiconductor Corporation. All other brand or product names may be trademarks or registered trademarks of their respective holders.

Copyright© 2008 National Semiconductor Corporation

For the most current product information visit us at [www.national.com](http://www.national.com)



**National Semiconductor  
Americas Technical  
Support Center**  
Email:  
[new.feedback@nsc.com](mailto:new.feedback@nsc.com)  
Tel: 1-800-272-9959

**National Semiconductor Europe  
Technical Support Center**  
Email: [europe.support@nsc.com](mailto:europe.support@nsc.com)  
German Tel: +49 (0) 180 5010 771  
English Tel: +44 (0) 870 850 4288

**National Semiconductor Asia  
Pacific Technical Support Center**  
Email: [ap.support@nsc.com](mailto:ap.support@nsc.com)

**National Semiconductor Japan  
Technical Support Center**  
Email: [jpn.feedback@nsc.com](mailto:jpn.feedback@nsc.com)

## IMPORTANT NOTICE

Texas Instruments Incorporated and its subsidiaries (TI) reserve the right to make corrections, modifications, enhancements, improvements, and other changes to its products and services at any time and to discontinue any product or service without notice. Customers should obtain the latest relevant information before placing orders and should verify that such information is current and complete. All products are sold subject to TI's terms and conditions of sale supplied at the time of order acknowledgment.

TI warrants performance of its hardware products to the specifications applicable at the time of sale in accordance with TI's standard warranty. Testing and other quality control techniques are used to the extent TI deems necessary to support this warranty. Except where mandated by government requirements, testing of all parameters of each product is not necessarily performed.

TI assumes no liability for applications assistance or customer product design. Customers are responsible for their products and applications using TI components. To minimize the risks associated with customer products and applications, customers should provide adequate design and operating safeguards.

TI does not warrant or represent that any license, either express or implied, is granted under any TI patent right, copyright, mask work right, or other TI intellectual property right relating to any combination, machine, or process in which TI products or services are used. Information published by TI regarding third-party products or services does not constitute a license from TI to use such products or services or a warranty or endorsement thereof. Use of such information may require a license from a third party under the patents or other intellectual property of the third party, or a license from TI under the patents or other intellectual property of TI.

Reproduction of TI information in TI data books or data sheets is permissible only if reproduction is without alteration and is accompanied by all associated warranties, conditions, limitations, and notices. Reproduction of this information with alteration is an unfair and deceptive business practice. TI is not responsible or liable for such altered documentation. Information of third parties may be subject to additional restrictions.

Resale of TI products or services with statements different from or beyond the parameters stated by TI for that product or service voids all express and any implied warranties for the associated TI product or service and is an unfair and deceptive business practice. TI is not responsible or liable for any such statements.

TI products are not authorized for use in safety-critical applications (such as life support) where a failure of the TI product would reasonably be expected to cause severe personal injury or death, unless officers of the parties have executed an agreement specifically governing such use. Buyers represent that they have all necessary expertise in the safety and regulatory ramifications of their applications, and acknowledge and agree that they are solely responsible for all legal, regulatory and safety-related requirements concerning their products and any use of TI products in such safety-critical applications, notwithstanding any applications-related information or support that may be provided by TI. Further, Buyers must fully indemnify TI and its representatives against any damages arising out of the use of TI products in such safety-critical applications.

TI products are neither designed nor intended for use in military/aerospace applications or environments unless the TI products are specifically designated by TI as military-grade or "enhanced plastic." Only products designated by TI as military-grade meet military specifications. Buyers acknowledge and agree that any such use of TI products which TI has not designated as military-grade is solely at the Buyer's risk, and that they are solely responsible for compliance with all legal and regulatory requirements in connection with such use.

TI products are neither designed nor intended for use in automotive applications or environments unless the specific TI products are designated by TI as compliant with ISO/TS 16949 requirements. Buyers acknowledge and agree that, if they use any non-designated products in automotive applications, TI will not be responsible for any failure to meet such requirements.

Following are URLs where you can obtain information on other Texas Instruments products and application solutions:

### Products

Audio	<a href="http://www.ti.com/audio">www.ti.com/audio</a>
Amplifiers	<a href="http://amplifier.ti.com">amplifier.ti.com</a>
Data Converters	<a href="http://dataconverter.ti.com">dataconverter.ti.com</a>
DLP® Products	<a href="http://www.dlp.com">www.dlp.com</a>
DSP	<a href="http://dsp.ti.com">dsp.ti.com</a>
Clocks and Timers	<a href="http://www.ti.com/clocks">www.ti.com/clocks</a>
Interface	<a href="http://interface.ti.com">interface.ti.com</a>
Logic	<a href="http://logic.ti.com">logic.ti.com</a>
Power Mgmt	<a href="http://power.ti.com">power.ti.com</a>
Microcontrollers	<a href="http://microcontroller.ti.com">microcontroller.ti.com</a>
RFID	<a href="http://www.ti-rfid.com">www.ti-rfid.com</a>
OMAP Mobile Processors	<a href="http://www.ti.com/omap">www.ti.com/omap</a>
Wireless Connectivity	<a href="http://www.ti.com/wirelessconnectivity">www.ti.com/wirelessconnectivity</a>

### Applications

Communications and Telecom	<a href="http://www.ti.com/communications">www.ti.com/communications</a>
Computers and Peripherals	<a href="http://www.ti.com/computers">www.ti.com/computers</a>
Consumer Electronics	<a href="http://www.ti.com/consumer-apps">www.ti.com/consumer-apps</a>
Energy and Lighting	<a href="http://www.ti.com/energy">www.ti.com/energy</a>
Industrial	<a href="http://www.ti.com/industrial">www.ti.com/industrial</a>
Medical	<a href="http://www.ti.com/medical">www.ti.com/medical</a>
Security	<a href="http://www.ti.com/security">www.ti.com/security</a>
Space, Avionics and Defense	<a href="http://www.ti.com/space-avionics-defense">www.ti.com/space-avionics-defense</a>
Transportation and Automotive	<a href="http://www.ti.com/automotive">www.ti.com/automotive</a>
Video and Imaging	<a href="http://www.ti.com/video">www.ti.com/video</a>

TI E2E Community Home Page

[e2e.ti.com](http://e2e.ti.com)

Mailing Address: Texas Instruments, Post Office Box 655303, Dallas, Texas 75265  
Copyright © 2011, Texas Instruments Incorporated