



1N4736A~1N4757A

SILICON ZENER DIODE

VOLTAGE 6.8 to 51 Volts

POWER 1.0 Watts

DO-41

Unit : inch(mm)

FEATURES

- Low profile package
- Built-in strain relief
- Low inductance
- High temperature soldering : 260°C /10 seconds at terminals
- Plastic package has Underwriters Laboratory Flammability Classification 94V-O
- In compliance with EU RoHS 2002/95/EC directives

MECHANICAL DATA

- Case: Molded plastic DO-41
- Epoxy:UL 94V-O rate flame retardant
- Terminals: Axial leads, solderable per MIL-STD-750, Method 2026 guaranteed
- Polarity: Color band denotes positive end
- Mounting position:Any
- Weight: 0.012 ounce, 0.3 gram
- Packing information
 - B - 1K per Bulk box
 - T/R - 5K per 13" paper Reel
 - T/B - 2.5K per horiz. tape & Ammo box

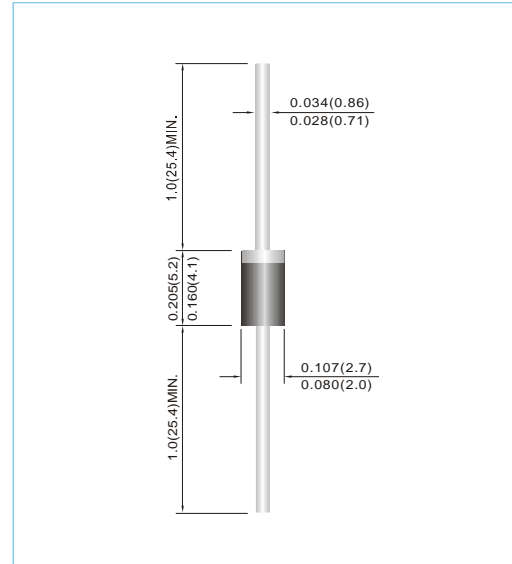

Datasheet.Live

MAXIMUM RATINGS AND ELECTRICAL CHARACTERISTICS

Ratings at 25°C ambient temperature unless otherwise specified.

Parameter	Symbol	Value	Units
Power Dissipation at Tamb = 25 °C	P _{TOT}	1*	W
Junction Temperature	T _J	-55 to + 150	°C
Storage Temperature Range	T _{STG}	-55 to + 150	°C

*Valid provided that leads at a distance of 10mm from case are kept at ambient temperature.



1N4736A~1N4757A

Part Number	Nominal Zener Voltage			Maximum Zener Impedance				Maximum Leakage Current		Marking Code
	V _Z @ I _{ZT}			Z _{ZT} @ I _{ZT}		Z _{ZK} @ I _{ZK}		I _R @ V _R		
	Nom. V	Min. V	Max. V	Ω	mA	Ω	mA	uA	V	DO-41
1.0 Watt ZENER										
1N4736A	6.8	6.46	7.14	3.5	37	700	1	5	4	1N4736A
1N4737A	7.5	7.13	7.88	4	34	700	0.5	5	5	1N4737A
1N4738A	8.2	7.79	8.61	4.5	31	700	0.5	5	6	1N4738A
1N4739A	9.1	8.65	9.56	5	28	700	0.5	0.5	7	1N4739A
1N4740A	10	9.5	10.5	7	25	700	0.25	0.5	7.6	1N4740A
1N4741A	11	10.45	11.55	8	23	700	0.25	0.1	8.4	1N4741A
1N4742A	12	11.4	12.6	9	21	700	0.25	0.1	9.1	1N4742A
1N4743A	13	12.35	13.65	10	19	700	0.25	0.1	9.9	1N4743A
1N4744A	15	14.25	15.75	14	17	700	0.25	0.1	11.4	1N4744A
1N4745A	16	15.2	16.8	16	15.5	700	0.25	0.1	12.2	1N4745A
1N4746A	18	17.1	18.9	20	14	750	0.25	0.1	13.7	1N4746A
1N4747A	20	19	21	22	12.5	750	0.25	0.1	15.2	1N4747A
1N4748A	22	20.9	23.1	23	11.5	750	0.25	0.1	16.7	1N4748A
1N4749A	24	22.8	25.2	25	10.5	750	0.25	0.1	18.2	1N4749A
1N4750A	27	25.65	28.35	35	9.5	750	0.25	0.1	20.6	1N4750A
1N4751A	30	28.5	31.5	40	8.5	1000	0.25	0.1	22.8	1N4751A
1N4752A	33	31.35	34.65	45	7.5	1000	0.25	0.1	25.1	1N4752A
1N4753A	36	34.2	37.8	50	7	1000	0.25	0.1	27.4	1N4753A
1N4754A	39	37.05	40.95	60	6.5	1000	0.25	0.1	29.7	1N4754A
1N4755A	43	40.85	45.15	70	6	1500	0.25	0.1	32.7	1N4755A
1N4756A	47	44.65	49.35	80	5.5	1500	0.25	0.1	35.8	1N4756A
1N4757A	51	48.45	53.55	95	5	1500	0.25	0.1	38.8	1N4757A



1N4736A~1N4757A

NOTE:

1. Tolerance and Type Number Designation. The type numbers listed have a standard tolerance on the nominal zener voltage of $\pm 5\%$
2. Specials Available Include:
 - A. Nominal zener voltages between the voltages shown and tighter voltage tolerances.
 - B. Matched sets.
3. Zener Voltage (V_Z) Measurement. Guarantees the zener voltage when measured at 90 seconds while maintaining the lead temperature (T_L) at $30^\circ\text{C} \pm 1^\circ\text{C}$, from the diode body.
4. Zener Impedance (Z_Z) Derivation. The zener impedance is derived from the 60 cycle ac voltage, which results when an ac current having an rms value equal to 10% of the dc zener current (I_{ZT} or I_{ZK}) is superimposed on I_{ZT} or I_{ZK} .
5. Surge Current (I_r) Non-Repitative. The rating listed in the electrical characteristics table is maximum peak, non-repetitive, reverse surge current of 1/2

RATING AND CHARACTERISTICS CURVES

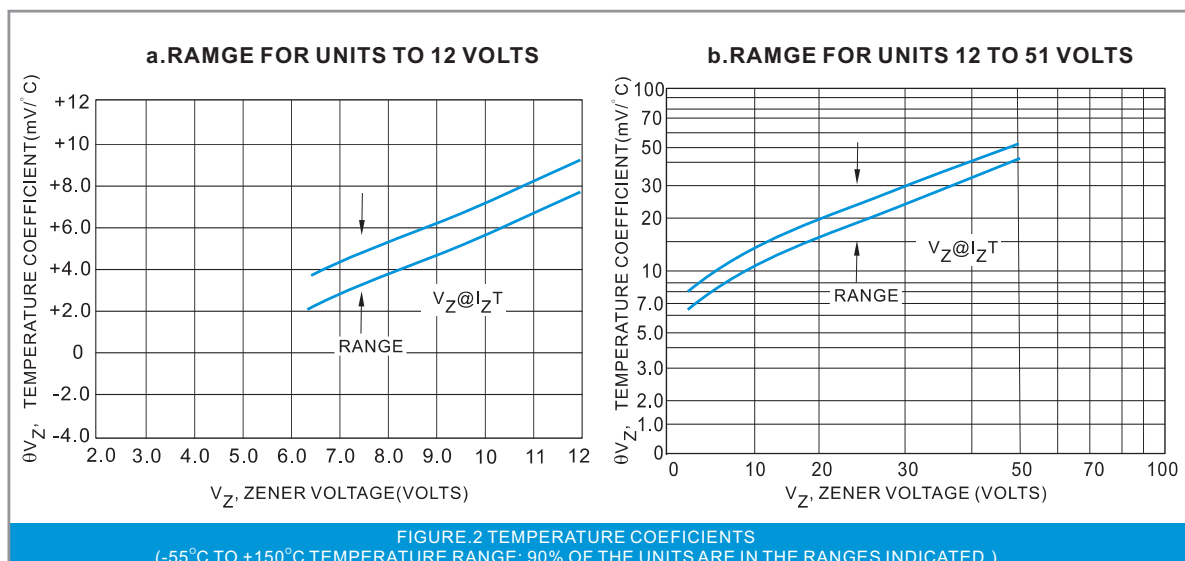
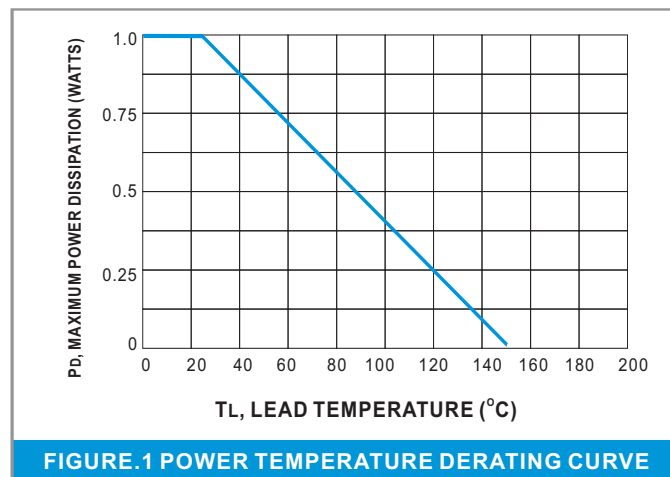



1N4736A~1N4757A

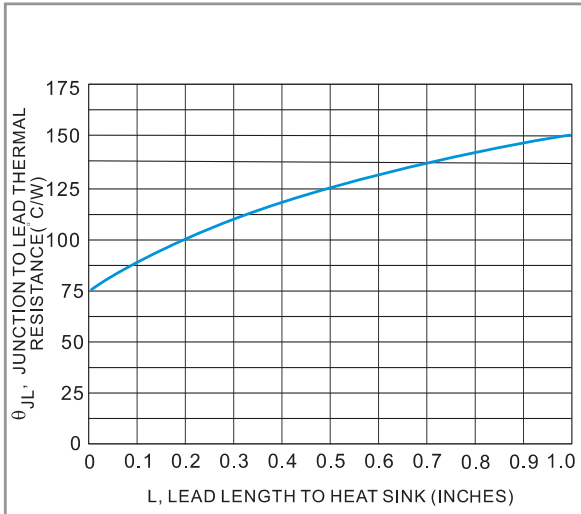

FIGURE.3 TYPICAL THERMAL RESISTANCE versus LEAD LENGTH

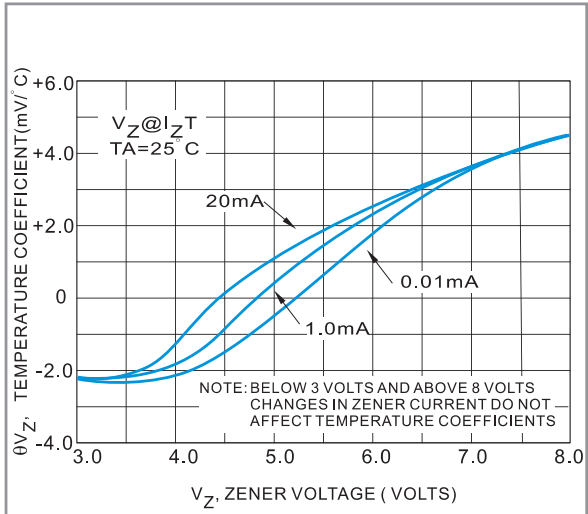
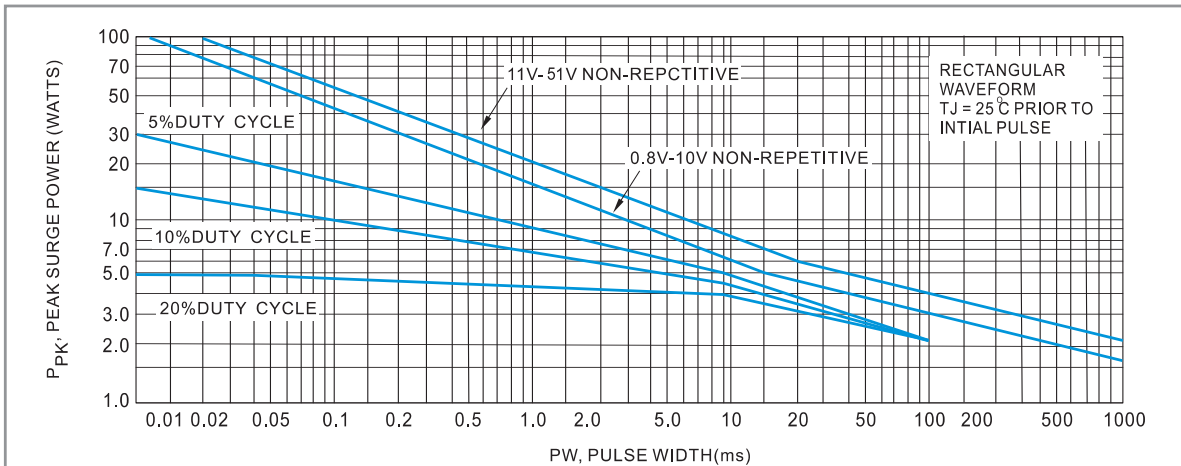

FIGURE.4 EFFECT OF ZENER CURRENT



This graph represents 90 percentile data points.
FOR worst-case design characteristics, multiply surge power by 2/3

FIGURE.5 MAXIMUM SURGE POWER

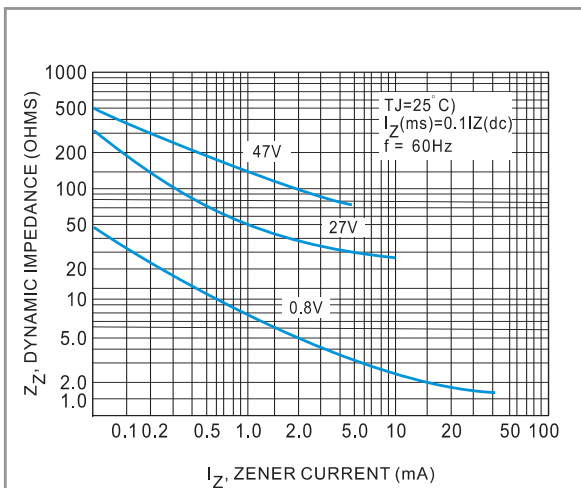

FIGURE.6 EFFECT OF ZENER CURRENT ON ZENER IMPEDANCE

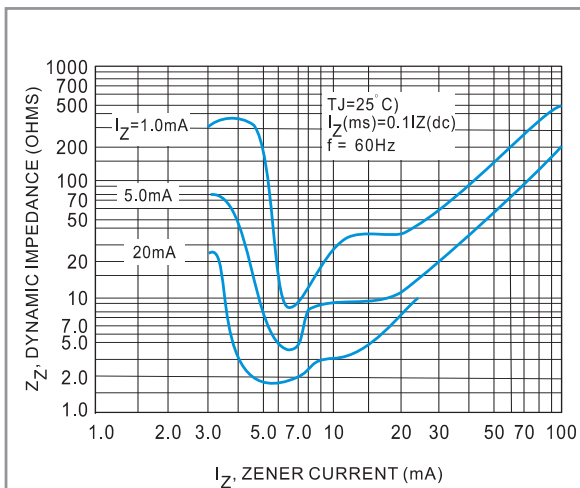

FIGURE.7 EFFECT OF ZENER VOLTAGE ON ZENER IMPEDANCE



1N4736A~1N4757A

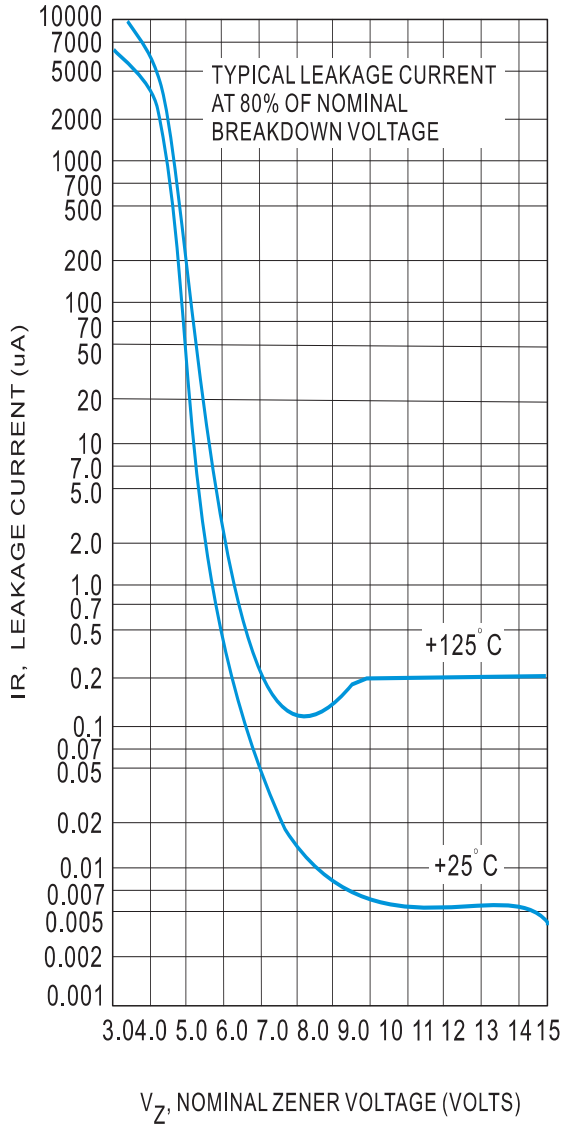

FIGURE.8 TYPICAL LEAKAGE CURRENT

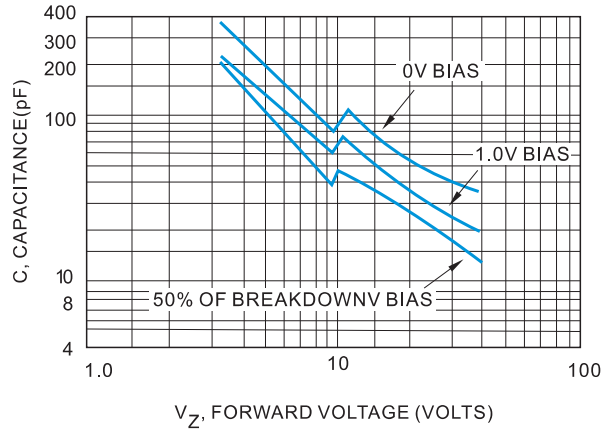

FIGURE.9 TYPICAL CAPACITANCE versus Vz

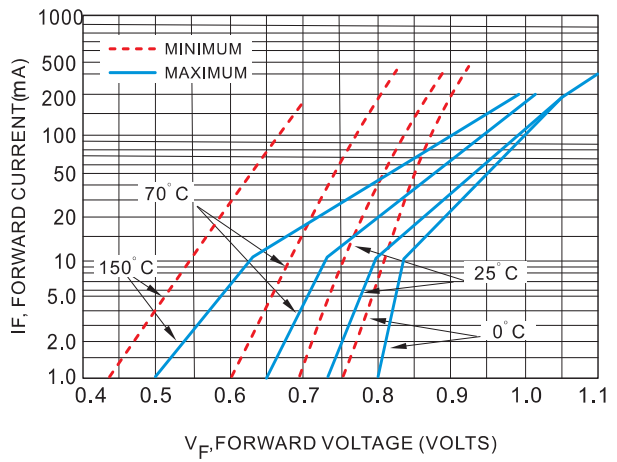

FIGURE.10 TYPICAL FORWARD CHARACTERISTICS