

# TPS7301Q, TPS7325Q, TPS7330Q, TPS7333Q, TPS7348Q, TPS7350Q LOW-DROPOUT VOLTAGE REGULATORS WITH INTEGRATED DELAYED RESET FUNCTION

SLVS124F – JUNE 1995 – REVISED JANUARY 1999

- Available in 2.5-V, 3-V, 3.3-V, 4.85-V, and 5-V Fixed-Output and Adjustable Versions
- Integrated Precision Supply-Voltage Supervisor Monitoring Regulator Output Voltage
- Active-Low Reset Signal with 200-ms Pulse Width
- Very Low Dropout Voltage . . . Maximum of 35 mV at  $I_O = 100$  mA (TPS7350)
- Low Quiescent Current – Independent of Load . . . 340  $\mu$ A Typ
- Extremely Low Sleep-State Current, 0.5  $\mu$ A Max
- 2% Tolerance Over Full Range of Load, Line, and Temperature for Fixed-Output Versions $\S$
- Output Current Range of 0 mA to 500 mA
- TSSOP Package Option Offers Reduced Component Height For Critical Applications

D OR P PACKAGE  
(TOP VIEW)

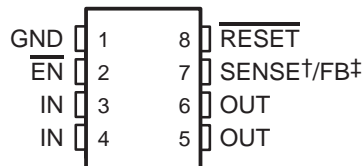

PW PACKAGE  
(TOP VIEW)

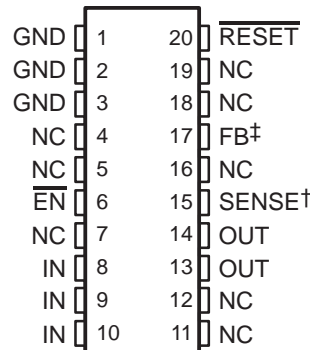

## description

The TPS73xx devices are members of a family of micropower low-dropout (LDO) voltage regulators. They are differentiated from the TPS71xx and TPS72xx LDOs by their integrated delayed microprocessor-reset function. If the precision delayed reset is not required, the TPS71xx and TPS72xx should be considered. $\parallel$

NC – No internal connection

$\dagger$  SENSE – Fixed voltage options only (TPS7325, TPS7330, TPS7333, TPS7348, and TPS7350)

$\ddagger$  FB – Adjustable version only (TPS7301)

## AVAILABLE OPTIONS

$T_J$	OUTPUT VOLTAGE (V)			NEGATIVE-GOING RESET THRESHOLD VOLTAGE (V)			PACKAGED DEVICES			CHIP FORM (Y)
	MIN	TYP	MAX	MIN	TYP	MAX	SMALL OUTLINE (D)	PLASTIC DIP (P)	TSSOP (PW)	
–40°C to 125°C	4.9	5	5.1	4.55	4.65	4.75	TPS7350QD	TPS7350QP	TPS7350QPW	TPS7350Y
	4.75	4.85	4.95	4.5	4.6	4.7	TPS7348QD	TPS7348QP	TPS7348QPW	TPS7348Y
	3.23	3.3	3.37	2.868	2.934	3	TPS7333QD	TPS7333QP	TPS7333QPW	TPS7333Y
	2.94	3	3.06	2.58	2.64	2.7	TPS7330QD	TPS7330QP	TPS7330QPW	TPS7330Y
	2.425	2.5	2.575	2.23	2.32	2.39	TPS7325QD	TPS7325QP	TPS7325QPW	TPS7325Y
	Adjustable 1.2 V to 9.75 V			1.101	1.123	1.145	TPS7301QD	TPS7301QP	TPS7301QPW	TPS7301Y

The D and PW packages are available taped and reeled. Add an R suffix to device type (e.g., TPS7350QDR). The TPS7301Q is programmable using an external resistor divider (see application information). The chip form is tested at 25°C.

$\S$  The TPS7325 has a tolerance of  $\pm 3\%$  over the full temperature range.

$\parallel$  The TPS71xx and the TPS72xx are 500-mA and 250-mA output regulators respectively, offering performance similar to that of the TPS73xx but without the delayed-reset function. The TPS72xx devices are further differentiated by availability in 8-pin thin-shrink small-outline packages (TSSOP) for applications requiring minimum package size.



Please be aware that an important notice concerning availability, standard warranty, and use in critical applications of Texas Instruments semiconductor products and disclaimers thereto appears at the end of this data sheet.

PRODUCTION DATA information is current as of publication date. Products conform to specifications per the terms of Texas Instruments standard warranty. Production processing does not necessarily include testing of all parameters.



POST OFFICE BOX 655303 • DALLAS, TEXAS 75265

Copyright © 1999, Texas Instruments Incorporated

# TPS7301Q, TPS7325Q, TPS7330Q, TPS7333Q, TPS7348Q, TPS7350Q LOW-DROPOUT VOLTAGE REGULATORS WITH INTEGRATED DELAYED RESET FUNCTION

SLVS124F – JUNE 1995 – REVISED JANUARY 1999

## description (continued)

The  $\overline{\text{RESET}}$  output of the TPS73xx initiates a reset in microcomputer and microprocessor systems in the event of an undervoltage condition. An internal comparator in the TPS73xx monitors the output voltage of the regulator to detect an undervoltage condition on the regulated output voltage.

If that occurs, the  $\overline{\text{RESET}}$  output (open-drain NMOS) turns on, taking the  $\overline{\text{RESET}}$  signal low.  $\overline{\text{RESET}}$  stays low for the duration of the undervoltage condition. Once the undervoltage condition ceases, a 200-ms (typ) time-out begins. At the completion of the 200-ms delay,  $\overline{\text{RESET}}$  goes high.

An order of magnitude reduction in dropout voltage and quiescent current over conventional LDO performance is achieved by replacing the typical pnp pass transistor with a PMOS device.

Because the PMOS device behaves as a low-value resistor, the dropout voltage is very low (maximum of 35 mV at an output current of 100 mA for the TPS7350) and is directly proportional to the output current (see Figure 1). Additionally, since the PMOS pass element is a voltage-driven device, the quiescent current is low and remains constant, independent of output loading (typically 340  $\mu\text{A}$  over the full range of output current, 0 mA to 500 mA). These two key specifications yield a significant improvement in operating life for battery-powered systems.

The LDO family also features a sleep mode; applying a logic high signal to  $\overline{\text{EN}}$  (enable) shuts down the regulator, reducing the quiescent current to 0.5  $\mu\text{A}$  maximum at  $T_J = 25^\circ\text{C}$ .

The TPS73xx is offered in 2.5-V, 3-V, 3.3-V, 4.85-V, and 5-V fixed-voltage versions and in an adjustable version (programmable over the range of 1.2 V to 9.75 V). Output voltage tolerance is specified as a maximum of 2% over line, load, and temperature ranges (3% for the 2.5 V and the adjustable version). The TPS73xx family is available in PDIP (8 pin), SO (8 pin) and TSSOP (20 pin) packages. The TSSOP has a maximum height of 1.2 mm.



Figure 1. Dropout Voltage Versus Output Current

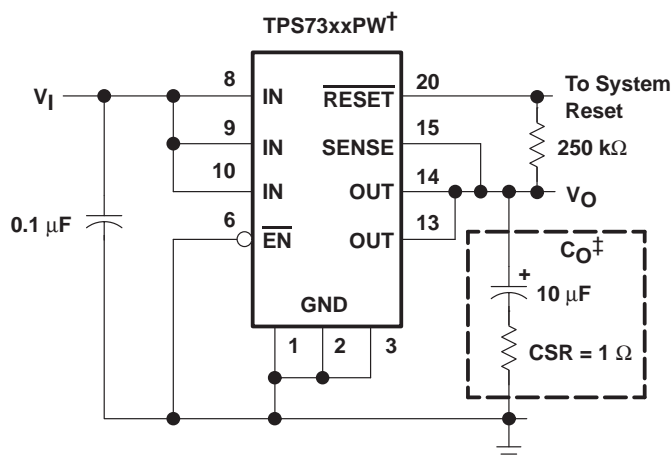

† TPS7325, TPS7330, TPS7333, TPS7348, TPS7350 (fixed-voltage options)

‡ Capacitor selection is nontrivial. See application information section for details.

Figure 2. Typical Application Configuration

# TPS7301Q, TPS7325Q, TPS7330Q, TPS7333Q, TPS7348Q, TPS7350Q LOW-DROPOUT VOLTAGE REGULATORS WITH INTEGRATED DELAYED RESET FUNCTION

SLVS124F – JUNE 1995 – REVISED JANUARY 1999

## TPS73xxY chip information

These chips, when properly assembled, display characteristics similar to those of the TPS73xxQ. Thermal compression or ultrasonic bonding may be used on the doped aluminum bonding pads. Chips may be mounted with conductive epoxy or a gold-silicon preform.



## functional block diagram

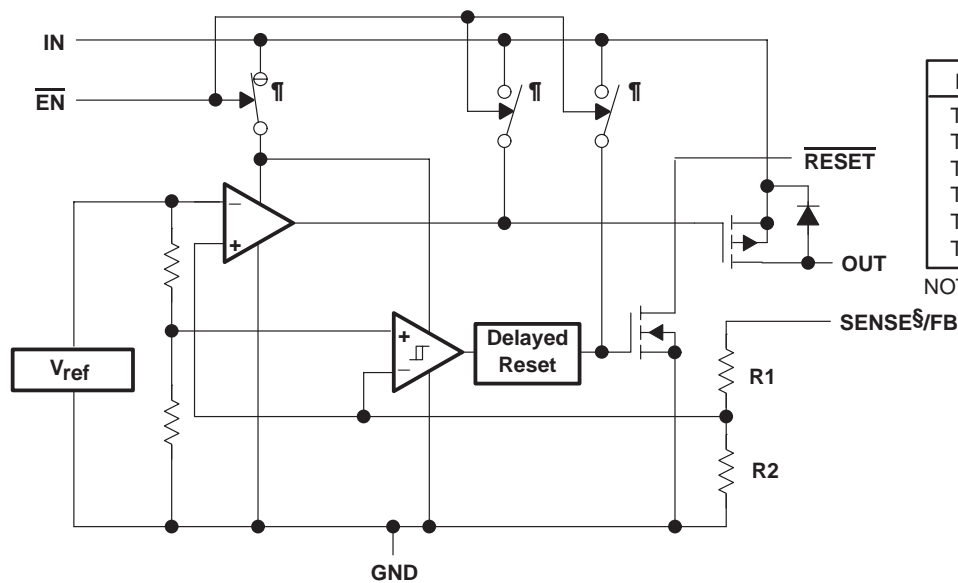

### RESISTOR DIVIDER OPTIONS

DEVICE	R1	R2	UNIT
TPS7301	0	∞	Ω
TPS7325	260	233	kΩ
TPS7330	358	233	kΩ
TPS7333	420	233	kΩ
TPS7348	726	233	kΩ
TPS7350	756	233	kΩ

NOTE A. Resistors are nominal values only.

### COMPONENT COUNT

MOS transistors	464
Bipolar transistors	41
Diodes	4
Capacitors	17
Resistors	76

§ For most applications, SENSE should be externally connected to OUT as close as possible to the device. For other implementations, refer to SENSE-pin connection discussion in applications information section.

¶ Switch positions are shown with EN low (active).

**TPS7301Q, TPS7325Q, TPS7330Q, TPS7333Q, TPS7348Q, TPS7350Q**  
**LOW-DROPOUT VOLTAGE REGULATORS**  
**WITH INTEGRATED DELAYED RESET FUNCTION**

SLVS124F – JUNE 1995 – REVISED JANUARY 1999

**timing diagram**



†  $V_{res}$  is the minimum input voltage for a valid  $\overline{RESET}$ . The symbol  $V_{res}$  is not currently listed within EIA or JEDEC standards for semiconductor symbology.

**absolute maximum ratings over operating free-air temperature range (unless otherwise noted)‡**

Input voltage range§, $V_I$ , $\overline{RESET}$ , SENSE, $\overline{EN}$ .....	-0.3 V to 11 V
Output current, $I_O$ .....	2 A
Continuous total power dissipation .....	See Dissipation Rating Tables 1 and 2
Operating virtual junction temperature range, $T_J$ .....	-55°C to 150°C
Storage temperature range, $T_{stg}$ .....	-65°C to 150°C
Lead temperature 1,6 mm (1/16 inch) from case for 10 seconds .....	260°C

‡ Stresses beyond those listed under "absolute maximum ratings" may cause permanent damage to the device. These are stress ratings only, and functional operation of the device at these or any other conditions beyond those indicated under "recommended operating conditions" is not implied. Exposure to absolute-maximum-rated conditions for extended periods may affect device reliability.

§ All voltage values are with respect to network terminal ground.



POST OFFICE BOX 655303 • DALLAS, TEXAS 75265

TPS7301Q, TPS7325Q, TPS7330Q, TPS7333Q, TPS7348Q, TPS7350Q  
**LOW-DROPOUT VOLTAGE REGULATORS**  
**WITH INTEGRATED DELAYED RESET FUNCTION**

SLVS124F – JUNE 1995 – REVISED JANUARY 1999

DISSIPATION RATING TABLE 1 – FREE-AIR TEMPERATURE (SEE FIGURE 3)

PACKAGE	$T_A \leq 25^\circ\text{C}$ POWER RATING	DERATING FACTOR ABOVE $T_A = 25^\circ\text{C}$	$T_A = 70^\circ\text{C}$ POWER RATING	$T_A = 125^\circ\text{C}$ POWER RATING
D	725 mW	5.8 mW/°C	464 mW	145 mW
P	1175 mW	9.4 mW/°C	752 mW	235 mW
PW†	700 mW	5.6 mW/°C	448 mW	140 mW

DISSIPATION RATING TABLE 2 – CASE TEMPERATURE (SEE FIGURE 4)

PACKAGE	$T_C \leq 25^\circ\text{C}$ POWER RATING	DERATING FACTOR ABOVE $T_C = 25^\circ\text{C}$	$T_C = 70^\circ\text{C}$ POWER RATING	$T_C = 125^\circ\text{C}$ POWER RATING
D	2188 mW	9.4 mW/°C	1765 mW	1248 mW
P	2738 mW	21.9 mW/°C	1752 mW	548 mW
PW†	4025 mW	32.2 mW/°C	2576 mW	805 mW

† Refer to Thermal Information section for detailed power dissipation considerations when using the TSSOP package.

MAXIMUM CONTINUOUS DISSIPATION  
 vs  
 FREE-AIR TEMPERATURE

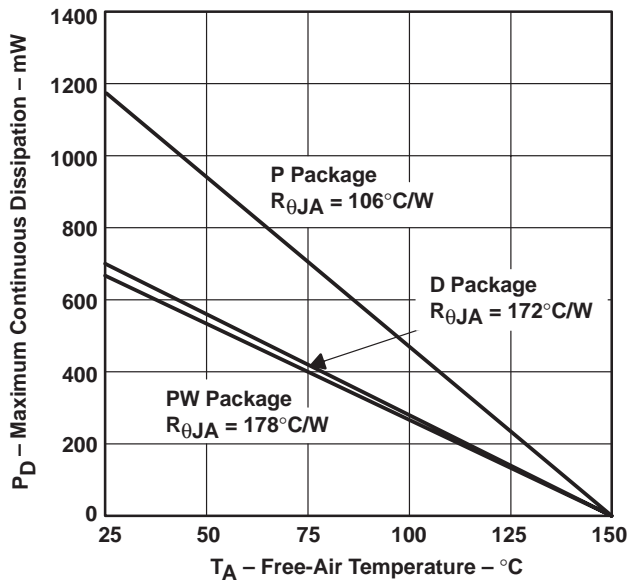

Figure 3

MAXIMUM CONTINUOUS DISSIPATION  
 vs  
 CASE TEMPERATURE

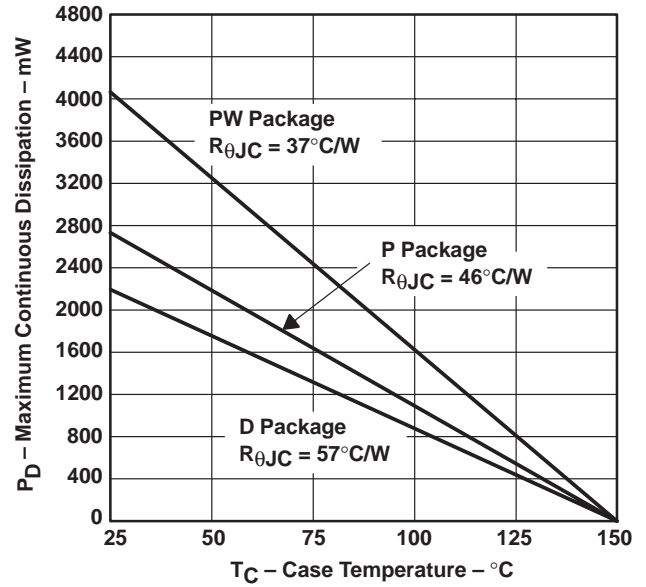

Figure 4

**TPS7301Q, TPS7325Q, TPS7330Q, TPS7333Q, TPS7348Q, TPS7350Q**  
**LOW-DROPOUT VOLTAGE REGULATORS**  
**WITH INTEGRATED DELAYED RESET FUNCTION**

SLVS124F – JUNE 1995 – REVISED JANUARY 1999

**recommended operating conditions**

		MIN	MAX	UNIT
Input voltage, $V_I$ †	TPS7301Q	2.47	10	V
	TPS7325Q	3.1	10	
	TPS7330Q	3.5	10	V
	TPS7333Q	3.77	10	V
	TPS7348Q	5.2	10	
	TPS7350Q	5.33	10	
High-level input voltage at $\overline{EN}$ , $V_{IH}$		2		V
Low-level input voltage at $\overline{EN}$ , $V_{IL}$			0.5	V
Output current range, $I_O$		0	500	mA
Operating virtual junction temperature range, $T_J$		-40	125	°C

† Minimum input voltage defined in the recommended operating conditions is the maximum specified output voltage plus dropout voltage,  $V_{DO}$ , at the maximum specified load range. Since dropout voltage is a function of output current, the usable range can be extended for lighter loads. To calculate the minimum input voltage for the maximum load current used in a given application, use the following equation:

$$V_{I(\min)} = V_{O(\max)} + V_{DO(\max \text{ load})}$$

Because the TPS7301 is programmable,  $r_{DS(on)}$  should be used to calculate  $V_{DO}$  before applying the above equation. The equation for calculating  $V_{DO}$  from  $r_{DS(on)}$  is given in Note 2 in the TPS7301 electrical characteristics table. The minimum value of 2.97 V is the absolute lower limit for the recommended input voltage range for the TPS7301.



**TPS7301Q, TPS7325Q, TPS7330Q, TPS7333Q, TPS7348Q, TPS7350Q**  
**LOW-DROPOUT VOLTAGE REGULATORS**  
**WITH INTEGRATED DELAYED RESET FUNCTION**

SLVS124F – JUNE 1995 – REVISED JANUARY 1999

**electrical characteristics at  $I_O = 10\text{ mA}$ ,  $\overline{EN} = 0\text{ V}$ ,  $C_O = 4.7\text{ }\mu\text{F}$  ( $CSR^\ddagger = 1\text{ }\Omega$ ), SENSE/FB shorted to OUT (unless otherwise noted)**

PARAMETER	TEST CONDITIONS <sup>§</sup>	T <sub>J</sub>	MIN	TYP	MAX	UNIT
Ground current (active mode)	$\overline{EN} \leq 0.5\text{ V}$ , $V_I = V_O + 1\text{ V}$ , $0\text{ mA} \leq I_O \leq 500\text{ mA}$	25°C		340	400	$\mu\text{A}$
		-40°C to 125°C			550	
Input current (standby mode)	$EN = V_I$ , $2.7\text{ V} \leq V_I \leq 10\text{ V}$	25°C		0.01	0.5	$\mu\text{A}$
		-40°C to 125°C			2	
Output current limit	$V_O = 0\text{ V}$ , $V_I = 10\text{ V}$	25°C		1.2	2	A
		-40°C to 125°C			2	
Pass-element leakage current in standby mode	$\overline{EN} = V_I$ , $2.7\text{ V} \leq V_I \leq 10\text{ V}$	25°C		0.01	0.5	$\mu\text{A}$
		-40°C to 125°C			1	
$\overline{RESET}$ leakage current	Normal operation, $V$ at $\overline{RESET} = 10\text{ V}$	25°C		0.02	0.5	$\mu\text{A}$
		-40°C to 125°C			0.5	
Output voltage temperature coefficient		-40°C to 125°C		61	75	ppm/°C
Thermal shutdown junction temperature				165		°C
$\overline{EN}$ logic high (standby mode)	$2.5\text{ V} \leq V_I \leq 6\text{ V}$	-40°C to 125°C		2		V
	$6\text{ V} \leq V_I \leq 10\text{ V}$			2.7		
EN logic low (active mode)	$2.7\text{ V} \leq V_I \leq 10\text{ V}$	25°C			0.5	V
		-40°C to 125°C			0.5	
$\overline{EN}$ hysteresis voltage		25°C		50		mV
$\overline{EN}$ input current	$0\text{ V} \leq V_I \leq 10\text{ V}$	25°C	-0.5	0.001	0.5	$\mu\text{A}$
		-40°C to 125°C	-0.5		0.5	
Minimum $V_I$ for active pass element		25°C		2.05	2.5	V
		-40°C to 125°C			2.5	
Minimum $V_I$ for valid $\overline{RESET}$	$I_O(\overline{RESET}) = -300\text{ }\mu\text{A}$	25°C		1	1.5	V
		-40°C to 125°C			1.9	

<sup>‡</sup> CSR (compensation series resistance) refers to the total series resistance, including the equivalent series resistance (ESR) of the capacitor, any series resistance added externally, and PWB trace resistance to  $C_O$ .

<sup>§</sup> Pulse-testing techniques are used to maintain virtual junction temperature as close as possible to ambient temperature; thermal effects must be taken into account separately.

**TPS7301Q, TPS7325Q, TPS7330Q, TPS7333Q, TPS7348Q, TPS7350Q**  
**LOW-DROPOUT VOLTAGE REGULATORS**  
**WITH INTEGRATED DELAYED RESET FUNCTION**

SLVS124F – JUNE 1995 – REVISED JANUARY 1999

**TPS7301Q electrical characteristics at  $I_O = 10\text{ mA}$ ,  $V_I = 3.5\text{ V}$ ,  $\overline{\text{EN}} = 0\text{ V}$ ,  $C_O = 4.7\text{ }\mu\text{F}$  ( $\text{CSR}^\dagger = 1\text{ }\Omega$ ), FB shorted to OUT at device leads (unless otherwise noted)**

PARAMETER	TEST CONDITIONS <sup>‡</sup>		T <sub>J</sub>	MIN	TYP	MAX	UNIT
Reference voltage (measured at FB)			25°C	1.182			V
	2.5 V ≤ V <sub>I</sub> ≤ 10 V, See Note 1	5 mA ≤ I <sub>O</sub> ≤ 500 mA,	–40°C to 125°C	1.147		1.217	V
Reference voltage temperature coefficient			–40°C to 125°C		61	75	ppm/°C
Pass-element series resistance (See Note 2)	V <sub>I</sub> = 2.4 V,	50 μA ≤ I <sub>O</sub> ≤ 150 mA	25°C	0.7		1	Ω
			–40°C to 125°C			1	
	V <sub>I</sub> = 2.4 V,	150 mA ≤ I <sub>O</sub> ≤ 500 mA	25°C	0.83		1.3	
			–40°C to 125°C			1.3	
	V <sub>I</sub> = 2.9 V,	50 μA ≤ I <sub>O</sub> ≤ 500 mA	25°C	0.52		0.85	
		–40°C to 125°C			0.85		
Input regulation	V <sub>I</sub> = 2.5 V to 10 V, See Note 1	50 μA ≤ I <sub>O</sub> ≤ 500 mA,	25°C	3		18	mV
			–40°C to 125°C			25	
Output regulation	2.5 V ≤ V <sub>I</sub> ≤ 10 V, See Note 1	I <sub>O</sub> = 5 mA to 500 mA,	25°C	5		14	mV
			–40°C to 125°C			25	
	2.5 V ≤ V <sub>I</sub> ≤ 10 V, See Note 1	I <sub>O</sub> = 50 μA to 500 mA,	25°C	7		22	mV
			–40°C to 125°C			54	
Ripple rejection	f = 120 Hz	I <sub>O</sub> = 50 μA	25°C	48	59		dB
			–40°C to 125°C			44	
		I <sub>O</sub> = 500 mA, See Note 1	25°C	45	54		
			–40°C to 125°C			44	
Output noise-spectral density	f = 120 Hz		25°C	2		μV/√Hz	
Output noise voltage	10 Hz ≤ f ≤ 100 kHz	C <sub>O</sub> = 4.7 μF	25°C	95		μV <sub>rms</sub>	
		C <sub>O</sub> = 10 μF	25°C	89			
		C <sub>O</sub> = 100 μF	25°C	74			
$\overline{\text{RESET}}$ trip-threshold voltage <sup>§</sup>	V <sub>O(FB)</sub> decreasing		–40°C to 125°C	1.101	1.145		V
$\overline{\text{RESET}}$ hysteresis voltage <sup>§</sup>	Measured at V <sub>O(FB)</sub>		25°C	12			mV
$\overline{\text{RESET}}$ output low voltage <sup>§</sup>	V <sub>I</sub> = 2.13 V,	I <sub>O</sub> (RESET) = 400 μA	25°C	0.1		0.4	V
			–40°C to 125°C			0.4	
FB input current			25°C	–10	0.1	10	nA
			–40°C to 125°C	–20	20		

<sup>†</sup> CSR refers to the total series resistance, including the ESR of the capacitor, any series resistance added externally, and PWB trace resistance to C<sub>O</sub>.

<sup>‡</sup> Pulse-testing techniques are used to maintain virtual junction temperature as close as possible to ambient temperature; thermal effects must be taken into account separately.

<sup>§</sup> Output voltage programmed to 2.5 V with closed-loop configuration (see application information).

- NOTES: 1. When V<sub>I</sub> < 2.9 V and I<sub>O</sub> > 150 mA simultaneously, pass element r<sub>DS(on)</sub> increases (see Figure 33) to a point where the resulting dropout voltage prevents the regulator from maintaining the specified tolerance range.
2. To calculate dropout voltage, use equation: V<sub>DO</sub> = I<sub>O</sub> · r<sub>DS(on)</sub>  
r<sub>DS(on)</sub> is a function of both output current and input voltage. This parametric table lists r<sub>DS(on)</sub> for V<sub>I</sub> = 2.4 V, 2.9 V, 3.9 V, and 5.9 V, which corresponds to dropout conditions for programmed output voltages of 2.5 V, 3 V, 4 V, and 6 V respectively. For other programmed values, refer to Figure 33.





**TPS7301Q, TPS7325Q, TPS7330Q, TPS7333Q, TPS7348Q, TPS7350Q**  
**LOW-DROPOUT VOLTAGE REGULATORS**  
**WITH INTEGRATED DELAYED RESET FUNCTION**

SLVS124F – JUNE 1995 – REVISED JANUARY 1999

**TPS7325Q electrical characteristics at  $I_O = 10\text{ mA}$ ,  $V_I = 3.5\text{ V}$ ,  $\overline{\text{EN}} = 0\text{ V}$ ,  $C_O = 10\text{ }\mu\text{F}$  ( $\text{CSR}^\dagger = 1\text{ }\Omega$ ), SENSE shorted to OUT (unless otherwise noted)**

PARAMETER	TEST CONDITIONS <sup>‡</sup>		T <sub>J</sub>	MIN	TYP	MAX	UNIT
Output voltage			25°C	2.45	2.5	2.55	V
	$3.5\text{ V} \leq V_I \leq 10\text{ V}$ ,	$5\text{ mA} \leq I_O \leq 500\text{ mA}$	-40°C to 125°C	2.425		2.575	
Dropout voltage <sup>§</sup>	$I_O = 10\text{ mA}$ ,	$V_I = 2.97\text{ V}$	25°C	5			mV
			-40°C to 125°C			14	
	$I_O = 100\text{ mA}$ ,	$V_I = 2.97\text{ V}$	25°C	50		80	
			-40°C to 125°C			150	
	$I_O = 500\text{ mA}$ ,	$V_I = 2.97\text{ V}$	25°C	270		400	
			-40°C to 125°C			600	
Pass-element series resistance <sup>§</sup>	$(2.97\text{ V} - V_O)/I_O$ , $I_O = 500\text{ mA}$	$V_I = 2.97\text{ V}$ ,	25°C	0.5		0.7	$\Omega$
			-40°C to 125°C			1.4	
Input regulation	$V_I = 3.5\text{ V to }10\text{ V}$ ,	$50\text{ }\mu\text{A} \leq I_O \leq 500\text{ mA}$	25°C	6		20	mV
			-40°C to 125°C			25	
Output regulation	$I_O = 5\text{ mA to }500\text{ mA}$ ,	$3.5\text{ V} \leq V_I \leq 10\text{ V}$	25°C	20		32	mV
			-40°C to 125°C			50	
	$I_O = 50\text{ }\mu\text{A to }500\text{ mA}$ ,	$3.5\text{ V} \leq V_I \leq 10\text{ V}$	25°C	28		60	mV
			-40°C to 125°C			100	
Ripple rejection	$f = 120\text{ Hz}$	$I_O = 50\text{ }\mu\text{A}$	25°C	50	53		dB
			-40°C to 125°C	49			
		$I_O = 500\text{ mA}$	25°C	49	53		
			-40°C to 125°C	32			
Output noise-spectral density	$f = 120\text{ Hz}$		25°C	2		$\mu\text{V}/\sqrt{\text{Hz}}$	
Output noise voltage	$10\text{ Hz} \leq f \leq 100\text{ kHz}$	$C_O = 4.7\text{ }\mu\text{F}$	25°C	274		$\mu\text{Vrms}$	
		$C_O = 10\text{ }\mu\text{F}$	25°C	228			
		$C_O = 100\text{ }\mu\text{F}$	25°C	159			
$\overline{\text{RESET}}$ trip-threshold voltage	$V_O$ decreasing		-40°C to 125°C	2.23	2.32	2.39	V
$\overline{\text{RESET}}$ output low voltage	$V_I = 2.1\text{ V}$ ,	$I_O(\text{RESET}) = -0.8\text{ mA}$	25°C	0.14		0.4	V
			-40°C to 125°C			0.4	

<sup>†</sup> CSR refers to the total series resistance, including the ESR of the capacitor, any series resistance added externally, and PWB trace resistance to  $C_O$ .

<sup>‡</sup> Pulse-testing techniques are used to maintain virtual junction temperature as close as possible to ambient temperature; thermal effects must be taken into account separately.

<sup>§</sup> Dropout test and pass-element series resistance test are not production tested. Test method requires SENSE terminal to be disconnected from output voltage.

**TPS7301Q, TPS7325Q, TPS7330Q, TPS7333Q, TPS7348Q, TPS7350Q**  
**LOW-DROPOUT VOLTAGE REGULATORS**  
**WITH INTEGRATED DELAYED RESET FUNCTION**

SLVS124F – JUNE 1995 – REVISED JANUARY 1999

**TPS7330Q electrical characteristics at  $I_O = 10\text{ mA}$ ,  $V_I = 4\text{ V}$ ,  $\overline{EN} = 0\text{ V}$ ,  $C_O = 4.7\text{ }\mu\text{F}$  ( $CSRT^\dagger = 1\text{ }\Omega$ ), SENSE shorted to OUT (unless otherwise noted)**

PARAMETER	TEST CONDITIONS‡		T <sub>J</sub>	MIN	TYP	MAX	UNIT
Output voltage			25°C	3			V
	$4\text{ V} \leq V_I \leq 10\text{ V}$ ,	$5\text{ mA} \leq I_O \leq 500\text{ mA}$	-40°C to 125°C	2.94	3.06		
Dropout voltage	$I_O = 10\text{ mA}$ ,	$V_I = 2.94\text{ V}$	25°C	5.2	7		mV
			-40°C to 125°C	10			
	$I_O = 100\text{ mA}$ ,	$V_I = 2.94\text{ V}$	25°C	52	75		
			-40°C to 125°C	100			
	$I_O = 500\text{ mA}$ ,	$V_I = 2.94\text{ V}$	25°C	267	450		
			-40°C to 125°C	500			
Pass-element series resistance	$(2.94\text{ V} - V_O)/I_O$ , $I_O = 500\text{ mA}$	$V_I = 2.94\text{ V}$ ,	25°C	0.5	0.7		$\Omega$
			-40°C to 125°C	1			
Input regulation	$V_I = 4\text{ V}$ to 10 V,	$50\text{ }\mu\text{A} \leq I_O \leq 500\text{ mA}$	25°C	6	23		mV
			-40°C to 125°C	29			
Output regulation	$I_O = 5\text{ mA}$ to 500 mA,	$4\text{ V} \leq V_I \leq 10\text{ V}$	25°C	20	32		mV
			-40°C to 125°C	60			
	$I_O = 50\text{ }\mu\text{A}$ to 500 mA,	$4\text{ V} \leq V_I \leq 10\text{ V}$	25°C	28	60		mV
			-40°C to 125°C	120			
Ripple rejection	$f = 120\text{ Hz}$	$I_O = 50\text{ }\mu\text{A}$	25°C	43	53		dB
			-40°C to 125°C	40			
		$I_O = 500\text{ mA}$	25°C	39	53		
			-40°C to 125°C	36			
Output noise-spectral density	$f = 120\text{ Hz}$		25°C	2		$\mu\text{V}/\sqrt{\text{Hz}}$	
Output noise voltage	$10\text{ Hz} \leq f \leq 100\text{ kHz}$	$C_O = 4.7\text{ }\mu\text{F}$	25°C	274		$\mu\text{V}_{\text{rms}}$	
		$C_O = 10\text{ }\mu\text{F}$	25°C	228			
		$C_O = 100\text{ }\mu\text{F}$	25°C	159			
$\overline{\text{RESET}}$ trip-threshold voltage	$V_O$ decreasing		-40°C to 125°C	2.58	2.64	2.7	V
$\overline{\text{RESET}}$ output low voltage	$V_I = 2.6\text{ V}$ ,	$I_O(\overline{\text{RESET}}) = -0.8\text{ mA}$	25°C	0.14	0.4		V
			-40°C to 125°C	0.4			

† CSR refers to the total series resistance, including the ESR of the capacitor, any series resistance added externally, and PWB trace resistance to  $C_O$ .

‡ Pulse-testing techniques are used to maintain virtual junction temperature as close as possible to ambient temperature; thermal effects must be taken into account separately.

**TPS7301Q, TPS7325Q, TPS7330Q, TPS7333Q, TPS7348Q, TPS7350Q**  
**LOW-DROPOUT VOLTAGE REGULATORS**  
**WITH INTEGRATED DELAYED RESET FUNCTION**

SLVS124F – JUNE 1995 – REVISED JANUARY 1999

**TPS7333Q electrical characteristics at  $I_O = 10\text{ mA}$ ,  $V_I = 4.3\text{ V}$ ,  $\overline{\text{EN}} = 0\text{ V}$ ,  $C_O = 4.7\text{ }\mu\text{F}$  ( $\text{CSR}^\dagger = 1\text{ }\Omega$ ), SENSE shorted to OUT (unless otherwise noted)**

PARAMETER	TEST CONDITIONS <sup>‡</sup>		T <sub>J</sub>	MIN	TYP	MAX	UNIT
Output voltage			25°C	3.3			V
	4.3 V ≤ V <sub>I</sub> ≤ 10 V, 5 mA ≤ I <sub>O</sub> ≤ 500 mA		–40°C to 125°C	3.23	3.37		
Dropout voltage	I <sub>O</sub> = 10 mA, V <sub>I</sub> = 3.23 V		25°C	4.5			mV
			–40°C to 125°C	8			
	I <sub>O</sub> = 100 mA, V <sub>I</sub> = 3.23 V		25°C	44			
			–40°C to 125°C	80			
	I <sub>O</sub> = 500 mA, V <sub>I</sub> = 3.23 V		25°C	235			
			–40°C to 125°C	400			
Pass-element series resistance	(3.23 V – V <sub>O</sub> )/I <sub>O</sub> , V <sub>I</sub> = 3.23 V, I <sub>O</sub> = 500 mA		25°C	0.44			Ω
			–40°C to 125°C	0.6			
Input regulation	V <sub>I</sub> = 4.3 V to 10 V, 50 μA ≤ I <sub>O</sub> ≤ 500 mA		25°C	6			mV
			–40°C to 125°C	23			
Output regulation	I <sub>O</sub> = 5 mA to 500 mA, 4.3 V ≤ V <sub>I</sub> ≤ 10 V		25°C	21			mV
			–40°C to 125°C	38			
	I <sub>O</sub> = 50 μA to 500 mA, 4.3 V ≤ V <sub>I</sub> ≤ 10 V		25°C	31			mV
			–40°C to 125°C	60			
Ripple rejection	f = 120 Hz	I <sub>O</sub> = 50 μA	25°C	43			dB
			–40°C to 125°C	51			
		I <sub>O</sub> = 500 mA	25°C	39			
			–40°C to 125°C	49			
Output noise-spectral density	f = 120 Hz		25°C	2			μV/√Hz
Output noise voltage	10 Hz ≤ f ≤ 100 kHz	C <sub>O</sub> = 4.7 μF	25°C	274			μVrms
		C <sub>O</sub> = 10 μF	25°C	228			
		C <sub>O</sub> = 100 μF	25°C	159			
$\overline{\text{RESET}}$ trip-threshold voltage	V <sub>O</sub> decreasing		–40°C to 125°C	2.868			V
$\overline{\text{RESET}}$ hysteresis voltage			25°C	18			mV
$\overline{\text{RESET}}$ output low voltage	V <sub>I</sub> = 2.8 V, I <sub>O</sub> (RESET) = –1 mA		25°C	0.17			V
			–40°C to 125°C	0.4			

<sup>†</sup> CSR refers to the total series resistance, including the ESR of the capacitor, any series resistance added externally, and PWB trace resistance to C<sub>O</sub>.

<sup>‡</sup> Pulse-testing techniques are used to maintain virtual junction temperature as close as possible to ambient temperature; thermal effects must be taken into account separately.

**TPS7301Q, TPS7325Q, TPS7330Q, TPS7333Q, TPS7348Q, TPS7350Q**  
**LOW-DROPOUT VOLTAGE REGULATORS**  
**WITH INTEGRATED DELAYED RESET FUNCTION**

SLVS124F – JUNE 1995 – REVISED JANUARY 1999

**TPS7348Q electrical characteristics at  $I_O = 10\text{ mA}$ ,  $V_I = 5.85\text{ V}$ ,  $\overline{\text{EN}} = 0\text{ V}$ ,  $C_O = 4.7\text{ }\mu\text{F}$  ( $\text{CSRT}^\dagger = 1\text{ }\Omega$ ), SENSE shorted to OUT (unless otherwise noted)**

PARAMETER	TEST CONDITIONS‡	T <sub>J</sub>	MIN	TYP	MAX	UNIT
Output voltage		25°C		4.85		V
	$5.85\text{ V} \leq V_I \leq 10\text{ V}$ , $5\text{ mA} \leq I_O \leq 500\text{ mA}$	-40°C to 125°C	4.75		4.95	
Dropout voltage	$I_O = 10\text{ mA}$ , $V_I = 4.75\text{ V}$	25°C		2.9	6	mV
		-40°C to 125°C			8	
	$I_O = 100\text{ mA}$ , $V_I = 4.75\text{ V}$	25°C		28	37	
		-40°C to 125°C			54	
	$I_O = 500\text{ mA}$ , $V_I = 4.75\text{ V}$	25°C		150	180	
		-40°C to 125°C			250	
Pass-element series resistance	$(4.75\text{ V} - V_O)/I_O$ , $V_I = 4.75\text{ V}$ , $I_O = 500\text{ mA}$	25°C		0.28	0.37	$\Omega$
		-40°C to 125°C			0.52	
Input regulation	$V_I = 5.85\text{ V}$ to 10 V, $50\text{ }\mu\text{A} \leq I_O \leq 500\text{ mA}$	25°C		9	35	mV
		-40°C to 125°C			37	
Output regulation	$I_O = 5\text{ mA}$ to 500 mA, $5.85\text{ V} \leq V_I \leq 10\text{ V}$	25°C		28	42	mV
		-40°C to 125°C			80	
	$I_O = 50\text{ }\mu\text{A}$ to 500 mA, $5.85\text{ V} \leq V_I \leq 10\text{ V}$	25°C		42	65	mV
		-40°C to 125°C			130	
Ripple rejection	$f = 120\text{ Hz}$	$I_O = 50\text{ }\mu\text{A}$	25°C	42	53	dB
			-40°C to 125°C	39		
		$I_O = 500\text{ mA}$	25°C	39	50	
			-40°C to 125°C	35		
Output noise-spectral density	$f = 120\text{ Hz}$	25°C		2	$\mu\text{V}/\sqrt{\text{Hz}}$	
Output noise voltage	$10\text{ Hz} \leq f \leq 100\text{ kHz}$	$C_O = 4.7\text{ }\mu\text{F}$	25°C	410	$\mu\text{V}_{\text{rms}}$	
		$C_O = 10\text{ }\mu\text{F}$	25°C	328		
		$C_O = 100\text{ }\mu\text{F}$	25°C	212		
$\overline{\text{RESET}}$ trip-threshold voltage	$V_O$ decreasing	-40°C to 125°C	4.5		4.7	V
$\overline{\text{RESET}}$ hysteresis voltage		25°C		26		mV
$\overline{\text{RESET}}$ output low voltage	$I_O(\overline{\text{RESET}}) = -1.2\text{ mA}$ , $V_I = 4.12\text{ V}$	25°C		0.2	0.4	V
		-40°C to 125°C			0.4	

† CSR refers to the total series resistance, including the ESR of the capacitor, any series resistance added externally, and PWB trace resistance to  $C_O$ .

‡ Pulse-testing techniques are used to maintain virtual junction temperature as close as possible to ambient temperature; thermal effects must be taken into account separately.



**TPS7301Q, TPS7325Q, TPS7330Q, TPS7333Q, TPS7348Q, TPS7350Q**  
**LOW-DROPOUT VOLTAGE REGULATORS**  
**WITH INTEGRATED DELAYED RESET FUNCTION**

SLVS124F – JUNE 1995 – REVISED JANUARY 1999

**TPS7350Q electrical characteristics at  $I_O = 10\text{ mA}$ ,  $V_I = 6\text{ V}$ ,  $\overline{\text{EN}} = 0\text{ V}$ ,  $C_O = 4.7\text{ }\mu\text{F}$  ( $\text{CSR}^\dagger = 1\text{ }\Omega$ ), SENSE shorted to OUT (unless otherwise noted)**

PARAMETER	TEST CONDITIONS <sup>‡</sup>		T <sub>J</sub>	MIN	TYP	MAX	UNIT
Output voltage			25°C	5			V
	$6\text{ V} \leq V_I \leq 10\text{ V}$ ,	$5\text{ mA} \leq I_O \leq 500\text{ mA}$	-40°C to 125°C	4.9	5.1		
Dropout voltage	$I_O = 10\text{ mA}$ ,	$V_I = 4.88\text{ V}$	25°C	2.9		6	mV
			-40°C to 125°C	8			
	$I_O = 100\text{ mA}$ ,	$V_I = 4.88\text{ V}$	25°C	27		35	
			-40°C to 125°C	50			
	$I_O = 500\text{ mA}$ ,	$V_I = 4.88\text{ V}$	25°C	146		170	
			-40°C to 125°C	230			
Pass-element series resistance	$(4.88\text{ V} - V_O)/I_O$ , $I_O = 500\text{ mA}$	$V_I = 4.88\text{ V}$ ,	25°C	0.27	0.35		$\Omega$
			-40°C to 125°C	0.5			
Input regulation	$V_I = 6\text{ V to } 10\text{ V}$ ,	$50\text{ }\mu\text{A} \leq I_O \leq 500\text{ mA}$	25°C	4		25	mV
			-40°C to 125°C	45			
Output regulation	$I_O = 5\text{ mA to } 500\text{ mA}$ ,	$6\text{ V} \leq V_I \leq 10\text{ V}$	25°C	30		45	mV
			-40°C to 125°C	86			
	$I_O = 50\text{ }\mu\text{A to } 500\text{ mA}$ ,	$6\text{ V} \leq V_I \leq 10\text{ V}$	25°C	45		65	mV
			-40°C to 125°C	140			
Ripple rejection	$f = 120\text{ Hz}$	$I_O = 50\text{ }\mu\text{A}$	25°C	43	53		dB
			-40°C to 125°C	38			
		$I_O = 500\text{ mA}$	25°C	41	51		
			-40°C to 125°C	36			
Output noise-spectral density	$f = 120\text{ Hz}$		25°C	2		$\mu\text{V}/\sqrt{\text{Hz}}$	
Output noise voltage	$10\text{ Hz} \leq f \leq 100\text{ kHz}$	$C_O = 4.7\text{ }\mu\text{F}$	25°C	430		$\mu\text{Vrms}$	
		$C_O = 10\text{ }\mu\text{F}$	25°C	345			
		$C_O = 100\text{ }\mu\text{F}$	25°C	220			
$\overline{\text{RESET}}$ trip-threshold voltage	$V_O$ decreasing		-40°C to 125°C	4.55	4.75		V
$\overline{\text{RESET}}$ hysteresis voltage			25°C	28		mV	
$\overline{\text{RESET}}$ output low voltage	$I_O(\text{RESET}) = -1.2\text{ mA}$ , $V_I = 4.25\text{ V}$		25°C	0.15	0.4		V
			-40°C to 125°C	0.4			

<sup>†</sup> CSR refers to the total series resistance, including the ESR of the capacitor, any series resistance added externally, and PWB trace resistance to  $C_O$ .

<sup>‡</sup> Pulse-testing techniques are used to maintain virtual junction temperature as close as possible to ambient temperature; thermal effects must be taken into account separately.

**TPS7301Q, TPS7325Q, TPS7330Q, TPS7333Q, TPS7348Q, TPS7350Q**  
**LOW-DROPOUT VOLTAGE REGULATORS**  
**WITH INTEGRATED DELAYED RESET FUNCTION**

SLVS124F – JUNE 1995 – REVISED JANUARY 1999

**switching characteristics**

PARAMETER	TEST CONDITIONS	T <sub>J</sub>	TPS7301Q, TPS7333Q TPS7348Q, TPS7350Q			UNIT
			MIN	TYP	MAX	
RESET time-out delay	See Figure 5	25°C	140	200	260	ms
		-40°C to 125°C	100		300	

**electrical characteristics at I<sub>O</sub> = 10 mA, EN = 0 V, C<sub>O</sub> = 4.7 μF (CSR† = 1 Ω), T<sub>J</sub> = 25°C, SENSE/FB shorted to OUT (unless otherwise noted)**

PARAMETER	TEST CONDITIONS‡	TPS7301Y, TPS7333Y TPS7348Y, TPS7350Y			UNIT
		MIN	TYP	MAX	
Ground current (active mode)	EN ≤ 0.5 V, V <sub>I</sub> = V <sub>O</sub> + 1 V, 0 mA ≤ I <sub>O</sub> ≤ 500 mA		340		μA
Input current (standby mode)	EN = V <sub>I</sub> , 2.7 V ≤ V <sub>I</sub> ≤ 10 V		0.01		μA
Output current limit	V <sub>O</sub> = 0 V, V <sub>I</sub> = 10 V		1.2		A
Pass-element leakage current in standby mode	EN = V <sub>I</sub> , 2.7 V ≤ V <sub>I</sub> ≤ 10 V		0.01		μA
RESET leakage current	Normal operation, V at RESET = 10 V		0.02		μA
Thermal shutdown junction temperature			165		°C
EN logic low (active mode)	2.7 V ≤ V <sub>I</sub> ≤ 10 V			0.5	V
EN hysteresis voltage			50		mV
EN input current	0 V ≤ V <sub>I</sub> ≤ 10 V		0.001		μA
Minimum V <sub>I</sub> for active pass element			2.05		V
Minimum V <sub>I</sub> for valid RESET	I <sub>O</sub> (RESET) = -300 μA		1		V

† CSR (compensation series resistance) refers to the total series resistance, including the equivalent series resistance (ESR) of the capacitor, any series resistance added externally, and PWB trace resistance to C<sub>O</sub>.

‡ Pulse-testing techniques are used to maintain virtual junction temperature as close as possible to ambient temperature; thermal effects must be taken into account separately.



**TPS7301Q, TPS7325Q, TPS7330Q, TPS7333Q, TPS7348Q, TPS7350Q**  
**LOW-DROPOUT VOLTAGE REGULATORS**  
**WITH INTEGRATED DELAYED RESET FUNCTION**

SLVS124F – JUNE 1995 – REVISED JANUARY 1999

**TPS7301Y electrical characteristics at  $I_O = 10\text{ mA}$ ,  $V_I = 3.5\text{ V}$ ,  $\overline{EN} = 0\text{ V}$ ,  $C_O = 4.7\text{ }\mu\text{F}$  ( $\text{CSR}^\dagger = 1\text{ }\Omega$ ),  $T_J = 25^\circ\text{C}$ , FB shorted to OUT at device leads (unless otherwise noted)**

PARAMETER	TEST CONDITIONS <sup>‡</sup>	MIN	TYP	MAX	UNIT
Reference voltage (measured at FB)			1.182		V
Pass-element series resistance (See Note 2)	$V_I = 2.4\text{ V}$ , $50\text{ }\mu\text{A} \leq I_O \leq 150\text{ mA}$		0.7		$\Omega$
	$V_I = 2.4\text{ V}$ , $150\text{ mA} \leq I_O \leq 500\text{ mA}$		0.83		
	$V_I = 2.9\text{ V}$ , $50\text{ }\mu\text{A} \leq I_O \leq 500\text{ mA}$		0.52		
	$V_I = 3.9\text{ V}$ , $50\text{ }\mu\text{A} \leq I_O \leq 500\text{ mA}$		0.32		
	$V_I = 5.9\text{ V}$ , $50\text{ }\mu\text{A} \leq I_O \leq 500\text{ mA}$		0.23		
Input regulation	$V_I = 2.5\text{ V to } 10\text{ V}$ , $50\text{ }\mu\text{A} \leq I_O \leq 500\text{ mA}$ , See Note 1		3		mV
Output regulation	$2.5\text{ V} \leq V_I \leq 10\text{ V}$ , $I_O = 5\text{ mA to } 500\text{ mA}$ , See Note 1		5		mV
	$2.5\text{ V} \leq V_I \leq 10\text{ V}$ , $I_O = 50\text{ }\mu\text{A to } 500\text{ mA}$ , See Note 1		7		mV
Ripple rejection	$f = 120\text{ Hz}$	$I_O = 50\text{ }\mu\text{A}$		59	dB
		$I_O = 500\text{ mA}$ , See Note 1		54	
Output noise-spectral density	$f = 120\text{ Hz}$		2		$\mu\text{V}/\sqrt{\text{Hz}}$
Output noise voltage	$10\text{ Hz} \leq f \leq 100\text{ kHz}$	$C_O = 4.7\text{ }\mu\text{F}$		95	$\mu\text{V}_{\text{rms}}$
		$C_O = 10\text{ }\mu\text{F}$		89	
		$C_O = 100\text{ }\mu\text{F}$		74	
$\overline{\text{RESET}}$ hysteresis voltage <sup>§</sup>	Measured at $V_O(\text{FB})$		12		mV
$\overline{\text{RESET}}$ output low voltage <sup>§</sup>	$V_I = 2.13\text{ V}$ , $I_O(\overline{\text{RESET}}) = 400\text{ }\mu\text{A}$		0.1		V
FB input current			0.1		nA

<sup>†</sup> CSR refers to the total series resistance, including the ESR of the capacitor, any series resistance added externally, and PWB trace resistance to  $C_O$ .

<sup>‡</sup> Pulse-testing techniques are used to maintain virtual junction temperature as close as possible to ambient temperature; thermal effects must be taken into account separately.

<sup>§</sup> Output voltage programmed to 2.5 V with closed-loop configuration (see application information).

- NOTES:
- When  $V_I < 2.9\text{ V}$  and  $I_O > 150\text{ mA}$  simultaneously, pass element  $r_{\text{DS(on)}}$  increases (see Figure 33) to a point where the resulting dropout voltage prevents the regulator from maintaining the specified tolerance range.
  - To calculate dropout voltage, use equation:  $V_{\text{DO}} = I_O \cdot r_{\text{DS(on)}}$   
 $r_{\text{DS(on)}}$  is a function of both output current and input voltage. The parametric table lists  $r_{\text{DS(on)}}$  for  $V_I = 2.4\text{ V}$ ,  $2.9\text{ V}$ ,  $3.9\text{ V}$ , and  $5.9\text{ V}$ , which corresponds to dropout conditions for programmed output voltages of 2.5 V, 3 V, 4 V, and 6 V respectively. For other programmed values, refer to Figure 33.

**TPS7301Q, TPS7325Q, TPS7330Q, TPS7333Q, TPS7348Q, TPS7350Q**  
**LOW-DROPOUT VOLTAGE REGULATORS**  
**WITH INTEGRATED DELAYED RESET FUNCTION**

SLVS124F – JUNE 1995 – REVISED JANUARY 1999

**TPS7325Y electrical characteristics at  $I_O = 10\text{ mA}$ ,  $V_I = 3.5\text{ V}$ ,  $\overline{EN} = 0\text{ V}$ ,  $C_O = 10\text{ }\mu\text{F}$  ( $CSR^\dagger = 1\text{ }\Omega$ ),  $T_J = 25^\circ\text{C}$ , SENSE shorted to OUT (unless otherwise noted)**

PARAMETER	TEST CONDITIONS‡	MIN	TYP	MAX	UNIT
Output voltage			2.5		V
Dropout voltage§	$I_O = 10\text{ mA}$ , $V_I = 2.97\text{ V}$		5		mV
	$I_O = 100\text{ mA}$ , $V_I = 2.97\text{ V}$		50		
	$I_O = 500\text{ mA}$ , $V_I = 2.97\text{ V}$		270		
Pass-element series resistance§	$(2.97\text{ V} - V_O)/I_O$ , $V_I = 2.97\text{ V}$ , $I_O = 500\text{ mA}$		0.5		$\Omega$
Input regulation	$V_I = 3.5\text{ V to }10\text{ V}$ , $50\text{ }\mu\text{A} \leq I_O \leq 500\text{ mA}$		6		mV
Output regulation	$I_O = 5\text{ mA to }500\text{ mA}$ , $3.5\text{ V} \leq V_I \leq 10\text{ V}$		20		mV
	$I_O = 50\text{ }\mu\text{A to }500\text{ mA}$ , $3.5\text{ V} \leq V_I \leq 10\text{ V}$		28		mV
Ripple rejection	$f = 120\text{ Hz}$	$I_O = 50\text{ }\mu\text{A}$		53	dB
		$I_O = 500\text{ mA}$		53	
Output noise-spectral density	$f = 120\text{ Hz}$		2		$\mu\text{V}/\sqrt{\text{Hz}}$
Output noise voltage	$10\text{ Hz} \leq f \leq 100\text{ kHz}$	$C_O = 4.7\text{ }\mu\text{F}$		274	$\mu\text{Vrms}$
		$C_O = 10\text{ }\mu\text{F}$		228	
		$C_O = 100\text{ }\mu\text{F}$		159	
$\overline{\text{RESET}}$ output low voltage	$V_I = 2.1\text{ V}$ , $I_O(\overline{\text{RESET}}) = -0.8\text{ mA}$		0.14		V

† CSR refers to the total series resistance, including the ESR of the capacitor, any series resistance added externally, and PWB trace resistance to  $C_O$ .

‡ Pulse-testing techniques are used to maintain virtual junction temperature as close as possible to ambient temperature; thermal effects must be taken into account separately.

§ Dropout test and pass-element series resistance test are not production tested. Test method requires SENSE terminal to be disconnected from output voltage.





**TPS7301Q, TPS7325Q, TPS7330Q, TPS7333Q, TPS7348Q, TPS7350Q**  
**LOW-DROPOUT VOLTAGE REGULATORS**  
**WITH INTEGRATED DELAYED RESET FUNCTION**

SLVS124F – JUNE 1995 – REVISED JANUARY 1999

**TPS7330Y electrical characteristics at  $I_O = 10\text{ mA}$ ,  $V_I = 4\text{ V}$ ,  $\overline{EN} = 0\text{ V}$ ,  $C_O = 4.7\text{ }\mu\text{F}$  ( $\text{CSR}^\dagger = 1\text{ }\Omega$ ),  $T_J = 25^\circ\text{C}$ , SENSE shorted to OUT (unless otherwise noted)**

PARAMETER	TEST CONDITIONS <sup>‡</sup>	MIN	TYP	MAX	UNIT
Output voltage			3		V
Dropout voltage	$I_O = 10\text{ mA}$ , $V_I = 2.94\text{ V}$		5.2		mV
	$I_O = 100\text{ mA}$ , $V_I = 2.94\text{ V}$		52		
	$I_O = 500\text{ mA}$ , $V_I = 2.94\text{ V}$		267		
Pass-element series resistance	$(2.94\text{ V} - V_O)/I_O$ , $V_I = 2.94\text{ V}$ , $I_O = 500\text{ mA}$		0.5		$\Omega$
Input regulation	$V_I = 4\text{ V to }10\text{ V}$ , $50\text{ }\mu\text{A} \leq I_O \leq 500\text{ mA}$		6		mV
Output regulation	$I_O = 5\text{ mA to }500\text{ mA}$ , $4\text{ V} \leq V_I \leq 10\text{ V}$		20		mV
	$I_O = 50\text{ }\mu\text{A to }500\text{ mA}$ , $4\text{ V} \leq V_I \leq 10\text{ V}$		28		mV
Ripple rejection	$f = 120\text{ Hz}$	$I_O = 50\text{ }\mu\text{A}$	53		dB
		$I_O = 500\text{ mA}$	53		
Output noise-spectral density	$f = 120\text{ Hz}$		2		$\mu\text{V}/\sqrt{\text{Hz}}$
Output noise voltage	$10\text{ Hz} \leq f \leq 100\text{ kHz}$	$C_O = 4.7\text{ }\mu\text{F}$	274		$\mu\text{V}_{\text{rms}}$
		$C_O = 10\text{ }\mu\text{F}$	228		
		$C_O = 100\text{ }\mu\text{F}$	159		
$\overline{\text{RESET}}$ output low voltage	$V_I = 2.6\text{ V}$ , $I_O(\overline{\text{RESET}}) = -0.8\text{ mA}$		0.14		V

<sup>†</sup> CSR refers to the total series resistance, including the ESR of the capacitor, any series resistance added externally, and PWB trace resistance to  $C_O$ .

<sup>‡</sup> Pulse-testing techniques are used to maintain virtual junction temperature as close as possible to ambient temperature; thermal effects must be taken into account separately.

**TPS7333Y electrical characteristics at  $I_O = 10\text{ mA}$ ,  $V_I = 4.3\text{ V}$ ,  $\overline{EN} = 0\text{ V}$ ,  $C_O = 4.7\text{ }\mu\text{F}$  ( $\text{CSR}^\dagger = 1\text{ }\Omega$ ),  $T_J = 25^\circ\text{C}$ , SENSE shorted to OUT (unless otherwise noted)**

PARAMETER	TEST CONDITIONS <sup>‡</sup>	MIN	TYP	MAX	UNIT
Output voltage			3.3		V
Dropout voltage	$I_O = 10\text{ mA}$ , $V_I = 3.23\text{ V}$		4.5		mV
	$I_O = 100\text{ mA}$ , $V_I = 3.23\text{ V}$		44		
	$I_O = 500\text{ mA}$ , $V_I = 3.23\text{ V}$		235		
Pass-element series resistance	$(3.23\text{ V} - V_O)/I_O$ , $V_I = 3.23\text{ V}$ , $I_O = 500\text{ mA}$		0.44		$\Omega$
Input regulation	$V_I = 4.3\text{ V to }10\text{ V}$ , $50\text{ }\mu\text{A} \leq I_O \leq 500\text{ mA}$		6		mV
Output regulation	$I_O = 5\text{ mA to }500\text{ mA}$ , $4.3\text{ V} \leq V_I \leq 10\text{ V}$		21		mV
	$I_O = 50\text{ }\mu\text{A to }500\text{ mA}$ , $4.3\text{ V} \leq V_I \leq 10\text{ V}$		31		mV
Ripple rejection	$f = 120\text{ Hz}$	$I_O = 50\text{ }\mu\text{A}$	51		dB
		$I_O = 500\text{ mA}$	49		
Output noise-spectral density	$f = 120\text{ Hz}$		2		$\mu\text{V}/\sqrt{\text{Hz}}$
Output noise voltage	$10\text{ Hz} \leq f \leq 100\text{ kHz}$	$C_O = 4.7\text{ }\mu\text{F}$	274		$\mu\text{V}_{\text{rms}}$
		$C_O = 10\text{ }\mu\text{F}$	228		
		$C_O = 100\text{ }\mu\text{F}$	159		
$\overline{\text{RESET}}$ hysteresis voltage			18		mV
$\overline{\text{RESET}}$ output low voltage	$V_I = 2.8\text{ V}$ , $I_O(\overline{\text{RESET}}) = -1\text{ mA}$		0.17		V

<sup>†</sup> CSR refers to the total series resistance, including the ESR of the capacitor, any series resistance added externally, and PWB trace resistance to  $C_O$ .

<sup>‡</sup> Pulse-testing techniques are used to maintain virtual junction temperature as close as possible to ambient temperature; thermal effects must be taken into account separately.



**TPS7301Q, TPS7325Q, TPS7330Q, TPS7333Q, TPS7348Q, TPS7350Q**  
**LOW-DROPOUT VOLTAGE REGULATORS**  
**WITH INTEGRATED DELAYED RESET FUNCTION**

SLVS124F – JUNE 1995 – REVISED JANUARY 1999

**TPS7348Y electrical characteristics at  $I_O = 10\text{ mA}$ ,  $V_I = 5.85\text{ V}$ ,  $\overline{EN} = 0\text{ V}$ ,  $C_O = 4.7\text{ }\mu\text{F}$  ( $CSRT = 1\text{ }\Omega$ ),  $T_J = 25^\circ\text{C}$ , SENSE shorted to OUT (unless otherwise noted)**

PARAMETER	TEST CONDITIONS‡	MIN	TYP	MAX	UNIT
Output voltage			4.85		V
Dropout voltage	$I_O = 10\text{ mA}$ , $V_I = 4.75\text{ V}$		2.9		mV
	$I_O = 100\text{ mA}$ , $V_I = 4.75\text{ V}$		28		
	$I_O = 500\text{ mA}$ , $V_I = 4.75\text{ V}$		150		
Pass-element series resistance	$(4.75\text{ V} - V_O)/I_O$ , $V_I = 4.75\text{ V}$ , $I_O = 500\text{ mA}$		0.28		$\Omega$
Input regulation	$V_I = 5.85\text{ V to }10\text{ V}$ , $50\text{ }\mu\text{A} \leq I_O \leq 500\text{ mA}$		9		mV
Output regulation	$I_O = 5\text{ mA to }500\text{ mA}$ , $5.85\text{ V} \leq V_I \leq 10\text{ V}$		28		mV
	$I_O = 50\text{ }\mu\text{A to }500\text{ mA}$ , $5.85\text{ V} \leq V_I \leq 10\text{ V}$		42		mV
Ripple rejection	$f = 120\text{ Hz}$	$I_O = 50\text{ }\mu\text{A}$		53	dB
		$I_O = 500\text{ mA}$		50	
Output noise-spectral density	$f = 120\text{ Hz}$		2		$\mu\text{V}/\sqrt{\text{Hz}}$
Output noise voltage	$10\text{ Hz} \leq f \leq 100\text{ kHz}$	$C_O = 4.7\text{ }\mu\text{F}$		410	$\mu\text{Vrms}$
		$C_O = 10\text{ }\mu\text{F}$		328	
		$C_O = 100\text{ }\mu\text{F}$		212	
$\overline{\text{RESET}}$ hysteresis voltage			26		mV
$\overline{\text{RESET}}$ output low voltage	$I_O(\overline{\text{RESET}}) = -1.2\text{ mA}$ , $V_I = 4.12\text{ V}$		0.2		V

† CSR refers to the total series resistance, including the ESR of the capacitor, any series resistance added externally, and PWB trace resistance to  $C_O$ .

‡ Pulse-testing techniques are used to maintain virtual junction temperature as close as possible to ambient temperature; thermal effects must be taken into account separately.



**TPS7301Q, TPS7325Q, TPS7330Q, TPS7333Q, TPS7348Q, TPS7350Q**  
**LOW-DROPOUT VOLTAGE REGULATORS**  
**WITH INTEGRATED DELAYED RESET FUNCTION**

SLVS124F – JUNE 1995 – REVISED JANUARY 1999

**TPS7350Y electrical characteristics at  $I_O = 10\text{ mA}$ ,  $V_I = 6\text{ V}$ ,  $\overline{EN} = 0\text{ V}$ ,  $C_O = 4.7\text{ }\mu\text{F}$  ( $CSR^\dagger = 1\text{ }\Omega$ ),  $T_J = 25^\circ\text{C}$ , SENSE shorted to OUT (unless otherwise noted)**

PARAMETER	TEST CONDITIONS‡	MIN	TYP	MAX	UNIT
Output voltage			5		V
Dropout voltage	$I_O = 10\text{ mA}$ , $V_I = 4.88\text{ V}$		2.9	6	mV
	$I_O = 100\text{ mA}$ , $V_I = 4.88\text{ V}$		27	35	
	$I_O = 500\text{ mA}$ , $V_I = 4.88\text{ V}$		146	170	
Pass-element series resistance	$(4.88\text{ V} - V_O)/I_O$ , $V_I = 4.88\text{ V}$ , $I_O = 500\text{ mA}$		0.27	0.35	$\Omega$
Input regulation	$V_I = 6\text{ V to }10\text{ V}$ , $50\text{ }\mu\text{A} \leq I_O \leq 500\text{ mA}$		4	25	mV
Output regulation	$I_O = 5\text{ mA to }500\text{ mA}$ , $6\text{ V} \leq V_I \leq 10\text{ V}$		28	75	mV
	$I_O = 50\text{ }\mu\text{A to }500\text{ mA}$ , $6\text{ V} \leq V_I \leq 10\text{ V}$		41		mV
Ripple rejection	$f = 120\text{ Hz}$	$I_O = 50\text{ }\mu\text{A}$		53	dB
		$I_O = 500\text{ mA}$		51	
Output noise-spectral density	$f = 120\text{ Hz}$		2		$\mu\text{V}/\sqrt{\text{Hz}}$
Output noise voltage	$10\text{ Hz} \leq f \leq 100\text{ kHz}$	$C_O = 4.7\text{ }\mu\text{F}$		430	$\mu\text{Vrms}$
		$C_O = 10\text{ }\mu\text{F}$		345	
		$C_O = 100\text{ }\mu\text{F}$		220	
$\overline{\text{RESET}}$ hysteresis voltage			28		mV
$\overline{\text{RESET}}$ output low voltage	$I_O(\overline{\text{RESET}}) = -1.2\text{ mA}$ , $V_I = 4.25\text{ V}$		0.15	0.4	V

† CSR refers to the total series resistance, including the ESR of the capacitor, any series resistance added externally, and PWB trace resistance to  $C_O$ .

‡ Pulse-testing techniques are used to maintain virtual junction temperature as close as possible to ambient temperature; thermal effects must be taken into account separately.

PARAMETER MEASUREMENT INFORMATION



Figure 5. Test Circuit and Voltage Waveforms



† Ceramic capacitor

Figure 6. Test Circuit for Typical Regions of Stability (Refer to Figures 29 through 32)

**TPS7301Q, TPS7325Q, TPS7330Q, TPS7333Q, TPS7348Q, TPS7350Q**  
**LOW-DROPOUT VOLTAGE REGULATORS**  
**WITH INTEGRATED DELAYED RESET FUNCTION**

SLVS124F – JUNE 1995 – REVISED JANUARY 1999

**TYPICAL CHARACTERISTICS**

**Table of Graphs**

$I_Q$	Quiescent current		vs Output current	7
			vs Input voltage	8
$I_Q$	Quiescent current	TPS7348	vs Free-air temperature	9
$I_Q$	Quiescent current	TPS7325	vs Input voltage	10
			vs Free-air temperature	11
$V_{DO}$	Dropout voltage		vs Output current	12
$\Delta V_{DO}$	Change in dropout voltage		vs Free-air temperature	13
$V_{DO}$	Dropout voltage	TPS7301	vs Output current	14
$\Delta V_O$	Change in output voltage		vs Free-air temperature	15
$V_O$	Output voltage		vs Input voltage	16
$V_O$	Output voltage	TPS7325	vs Input voltage	17
	Line regulation			18
$V_O$	Output voltage	TPS7301	vs Output current	19
		TPS7325	vs Output current	20
		TPS7330	vs Output current	21
		TPS7333	vs Output current	22
		TPS7348	vs Output current	23
		TPS7350	vs Output current	24
	Output voltage response from enable ( $\overline{EN}$ )			25
	Load transient response	TPS7301 or TPS7333		26
		TPS7325		27
		TPS7348 or TPS7350		28
		TPS7301		29
		TPS7333		30
		TPS7348 or TPS7350		31
	Ripple rejection		vs Frequency	32
	Output spectral noise density		vs Frequency	33
	Compensation series resistance (CSR)	$C_O = 4.7 \mu F$	vs Output current	34
			vs Added ceramic capacitance	35
		$C_O = 10 \mu F$	vs Output current	36
			vs Added ceramic capacitance	37
$r_{DS(on)}$	Pass-element resistance		vs Input voltage	38
$V_I$	Minimum input voltage for valid $\overline{RESET}$		vs Free-air temperature	39
$V_{IT-}$	Negative-going reset threshold		vs Free-air temperature	40
$I_{OL(RESET)}$	$\overline{RESET}$ output current		vs Input voltage	41
$t_d$	Reset time delay		vs Free-air temperature	42
$t_d$	Distribution for reset delay			43

**TPS7301Q, TPS7325Q, TPS7330Q, TPS7333Q, TPS7348Q, TPS7350Q**  
**LOW-DROPOUT VOLTAGE REGULATORS**  
**WITH INTEGRATED DELAYED RESET FUNCTION**

SLVS124F – JUNE 1995 – REVISED JANUARY 1999

**TYPICAL CHARACTERISTICS**

**QUIESCENT CURRENT  
vs  
OUTPUT CURRENT**

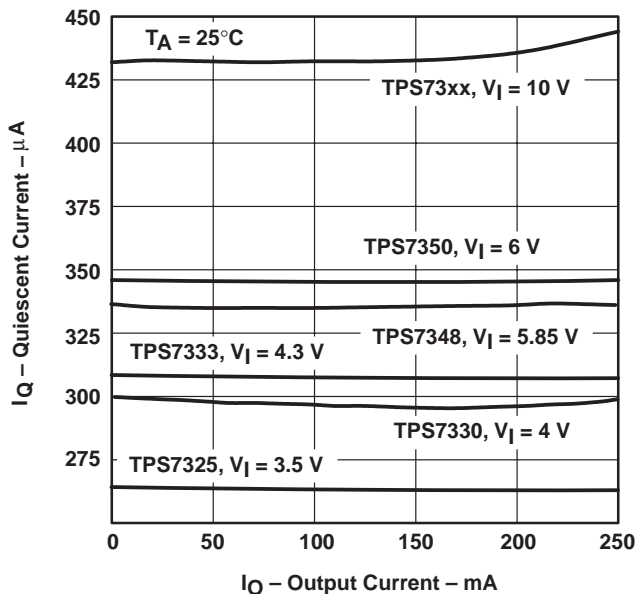

**Figure 7**

**QUIESCENT CURRENT  
vs  
INPUT VOLTAGE**



**Figure 8**

**TPS7348  
QUIESCENT CURRENT  
vs  
FREE-AIR TEMPERATURE**

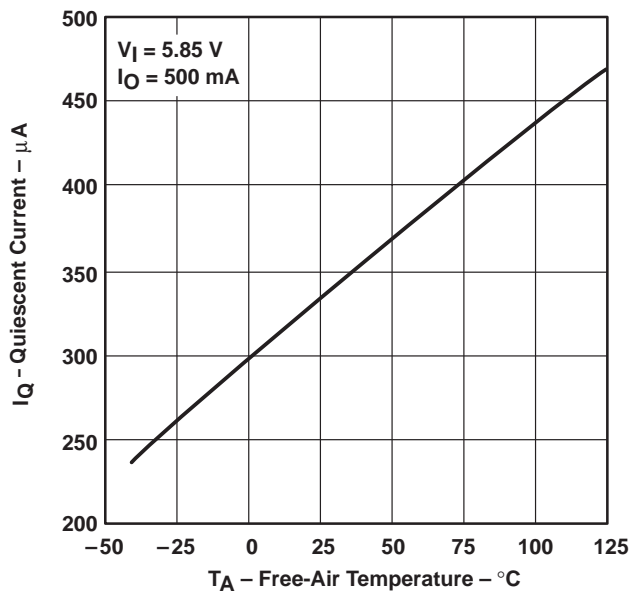

**Figure 9**

**TPS7325  
QUIESCENT CURRENT  
vs  
INPUT VOLTAGE**



**Figure 10**



TPS7301Q, TPS7325Q, TPS7330Q, TPS7333Q, TPS7348Q, TPS7350Q  
 LOW-DROPOUT VOLTAGE REGULATORS  
 WITH INTEGRATED DELAYED RESET FUNCTION

SLVS124F – JUNE 1995 – REVISED JANUARY 1999

TYPICAL CHARACTERISTICS

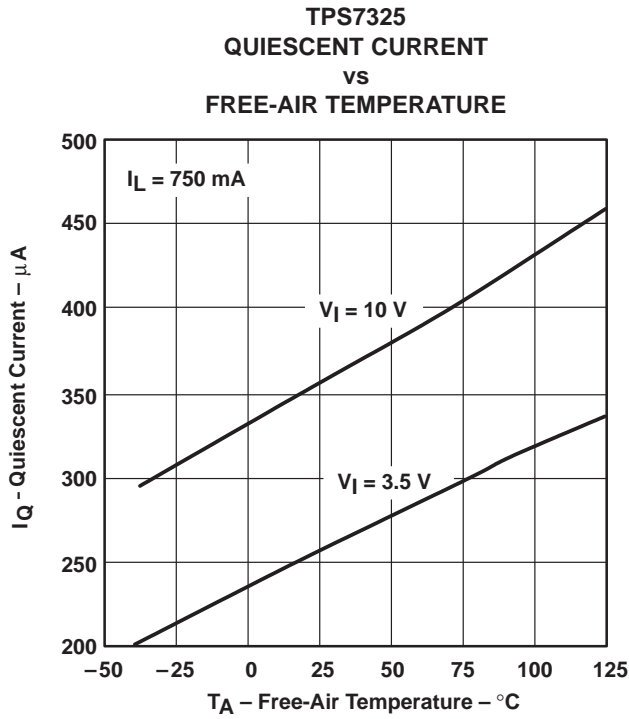

Figure 11



Figure 12

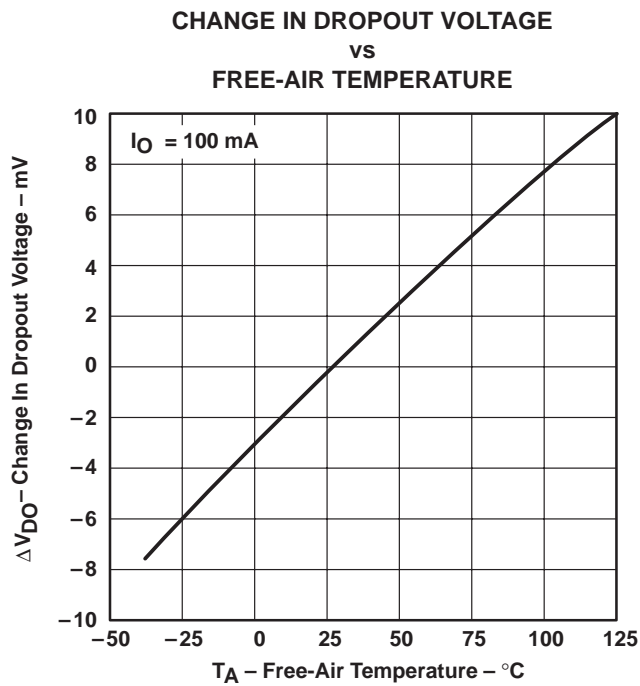

Figure 13



Figure 14

**TPS7301Q, TPS7325Q, TPS7330Q, TPS7333Q, TPS7348Q, TPS7350Q**  
**LOW-DROPOUT VOLTAGE REGULATORS**  
**WITH INTEGRATED DELAYED RESET FUNCTION**

SLVS124F – JUNE 1995 – REVISED JANUARY 1999

**TYPICAL CHARACTERISTICS**

**CHANGE IN OUTPUT VOLTAGE  
vs  
FREE-AIR TEMPERATURE**

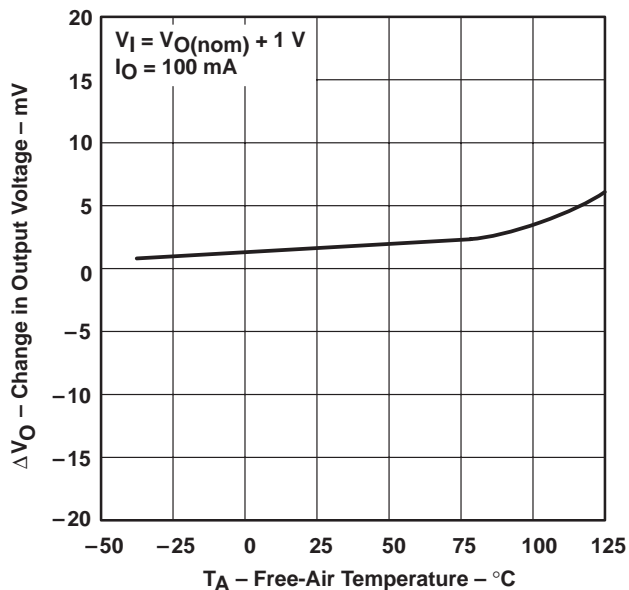

**Figure 15**

**OUTPUT VOLTAGE  
vs  
INPUT VOLTAGE**

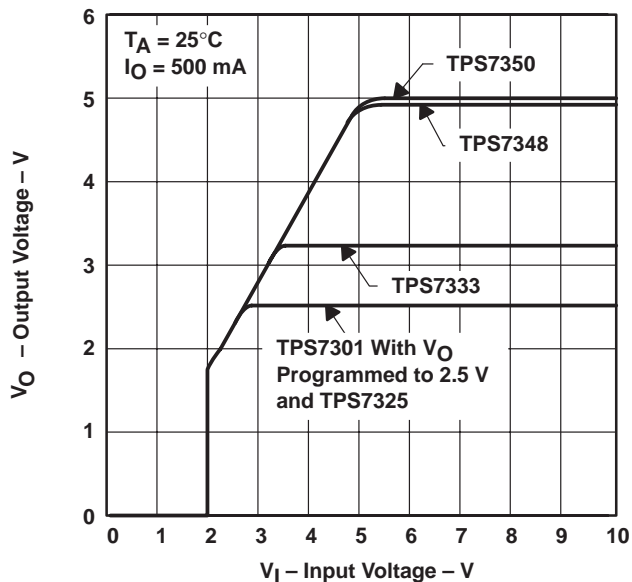

**Figure 16**

**TPS7325  
OUTPUT VOLTAGE  
vs  
INPUT VOLTAGE**

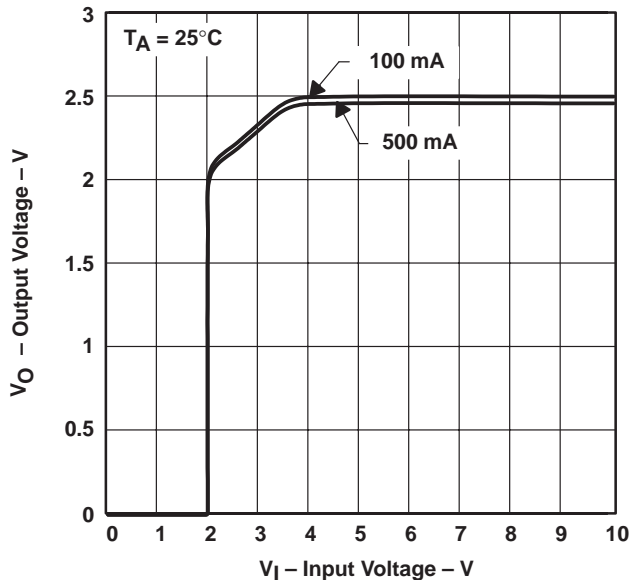

**Figure 17**

**LINE REGULATION**

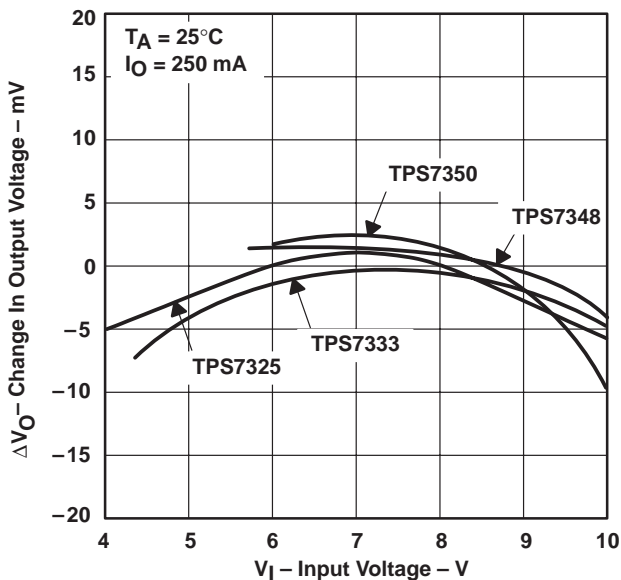

**Figure 18**





TPS7301Q, TPS7325Q, TPS7330Q, TPS7333Q, TPS7348Q, TPS7350Q  
 LOW-DROPOUT VOLTAGE REGULATORS  
 WITH INTEGRATED DELAYED RESET FUNCTION

SLVS124F – JUNE 1995 – REVISED JANUARY 1999

TYPICAL CHARACTERISTICS

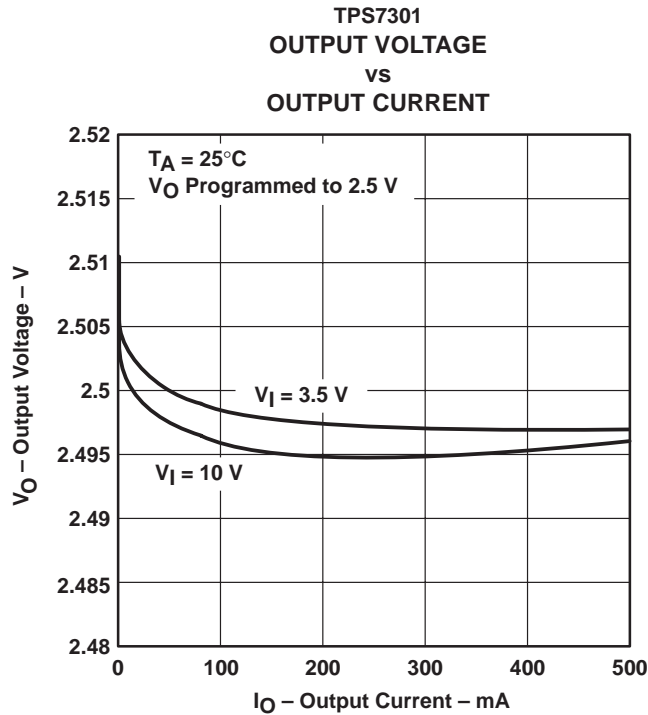

Figure 19

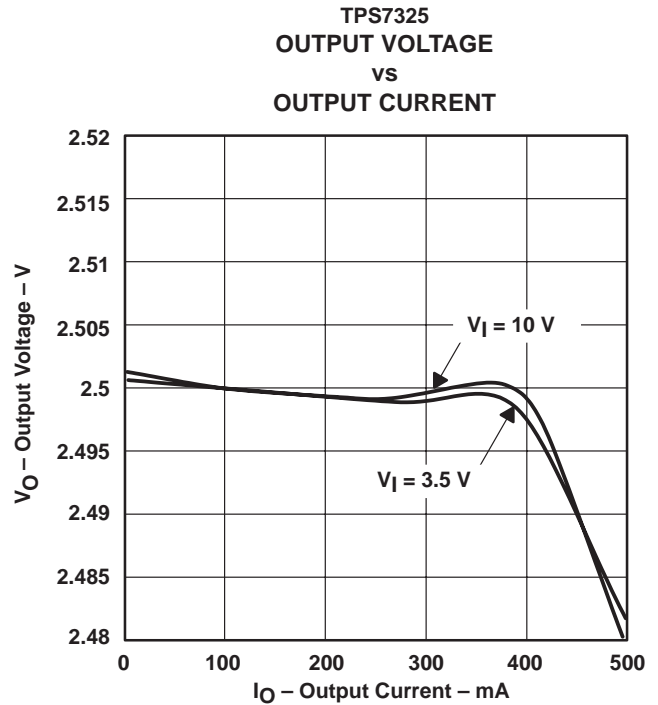

Figure 20

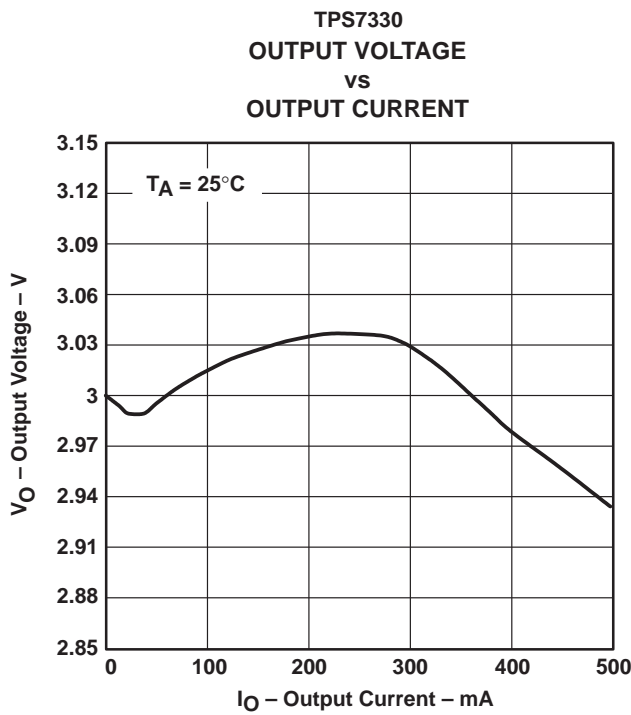

Figure 21

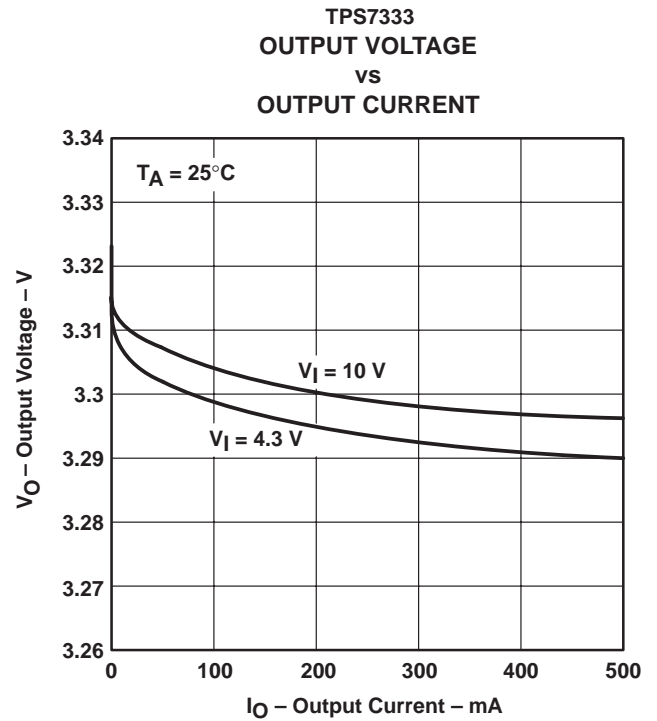

Figure 22



TPS7301Q, TPS7325Q, TPS7330Q, TPS7333Q, TPS7348Q, TPS7350Q  
 LOW-DROPOUT VOLTAGE REGULATORS  
 WITH INTEGRATED DELAYED RESET FUNCTION

SLVS124F – JUNE 1995 – REVISED JANUARY 1999

TYPICAL CHARACTERISTICS

TPS7348  
 OUTPUT VOLTAGE  
 VS  
 OUTPUT CURRENT

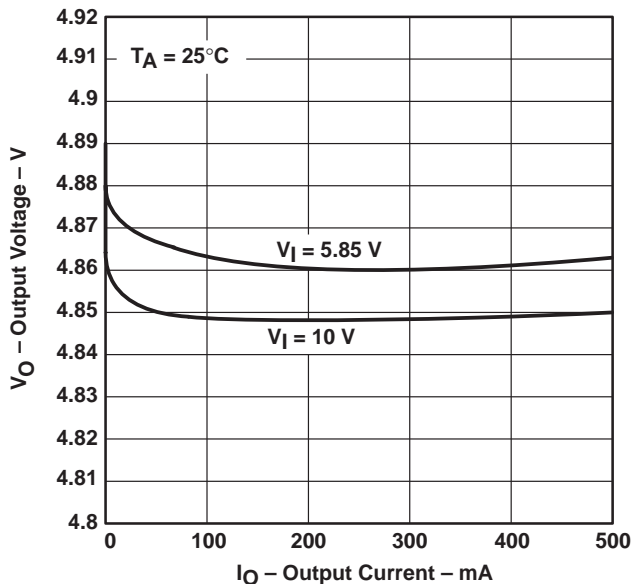

Figure 23

TPS7350  
 OUTPUT VOLTAGE  
 VS  
 OUTPUT CURRENT

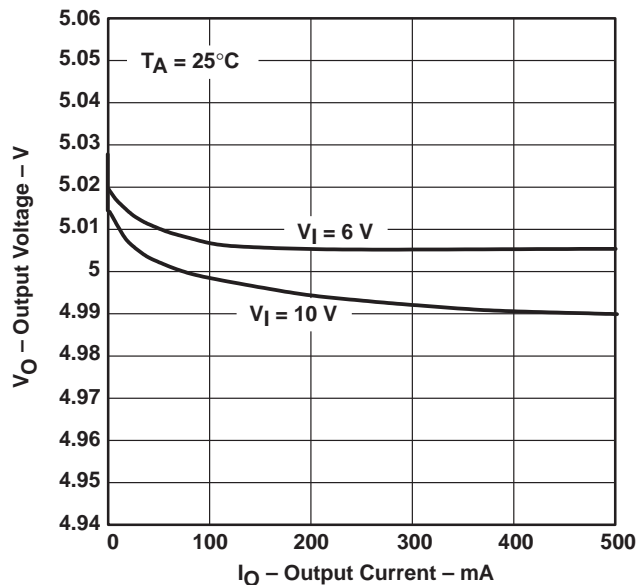

Figure 24

OUTPUT VOLTAGE RESPONSE FROM  
 ENABLE ( $\overline{\text{EN}}$ )

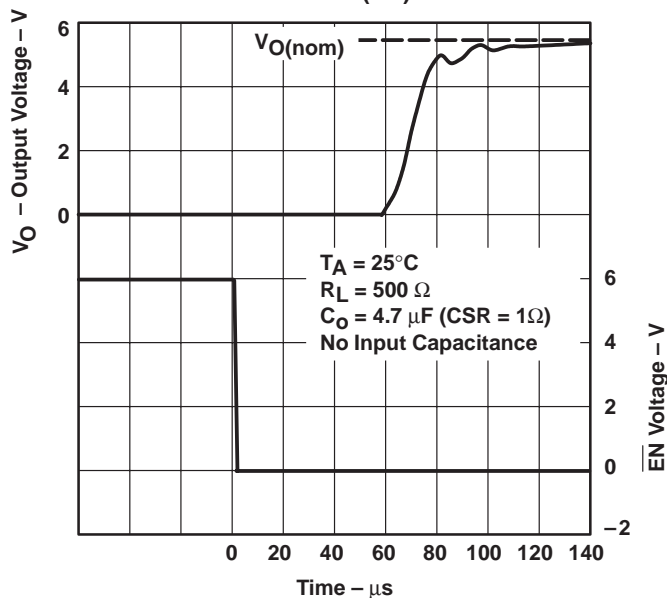
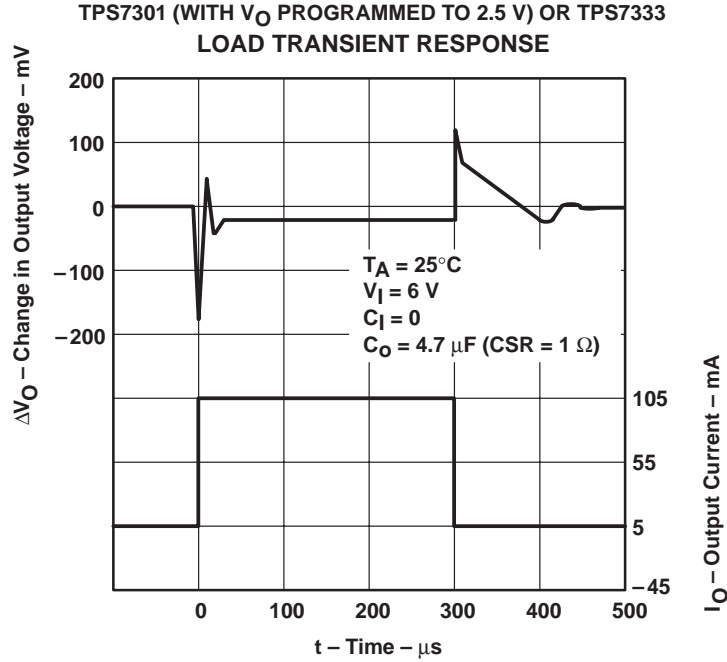
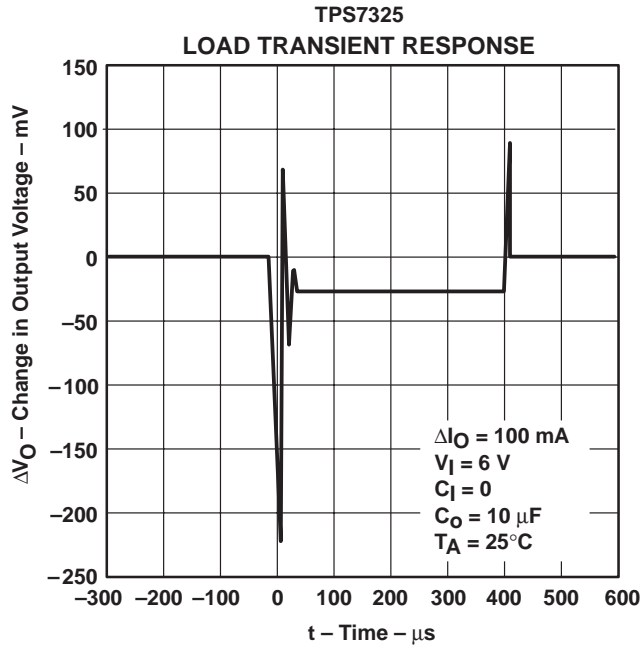

Figure 25

**TYPICAL CHARACTERISTICS**



**Figure 26**



**Figure 27**

TPS7301Q, TPS7325Q, TPS7330Q, TPS7333Q, TPS7348Q, TPS7350Q  
 LOW-DROPOUT VOLTAGE REGULATORS  
 WITH INTEGRATED DELAYED RESET FUNCTION

SLVS124F – JUNE 1995 – REVISED JANUARY 1999

TYPICAL CHARACTERISTICS

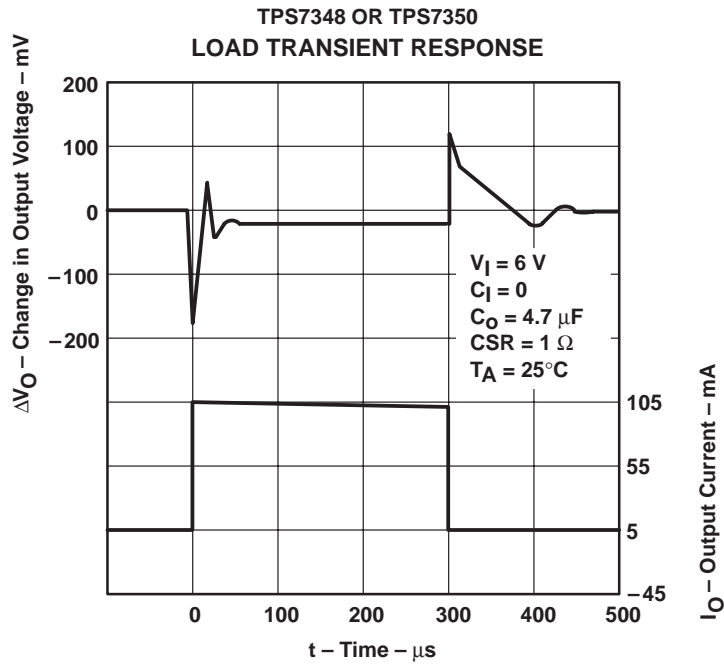

Figure 28

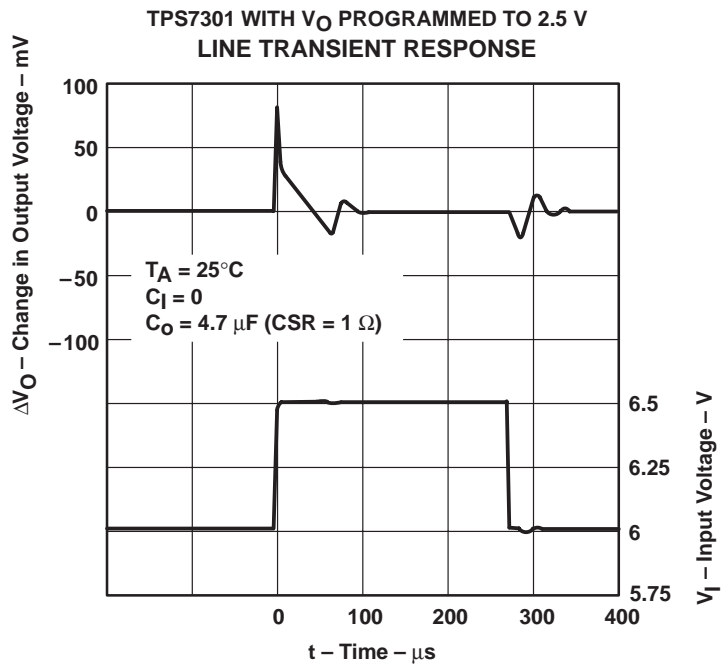
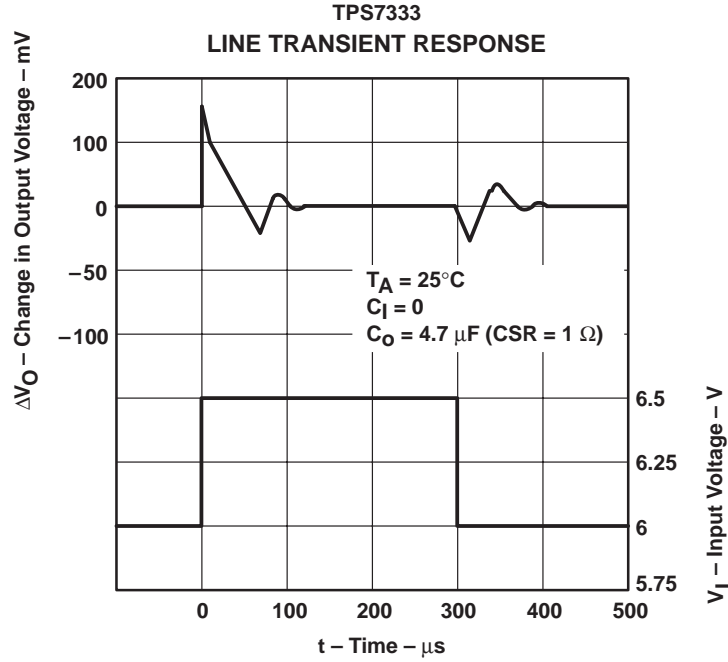
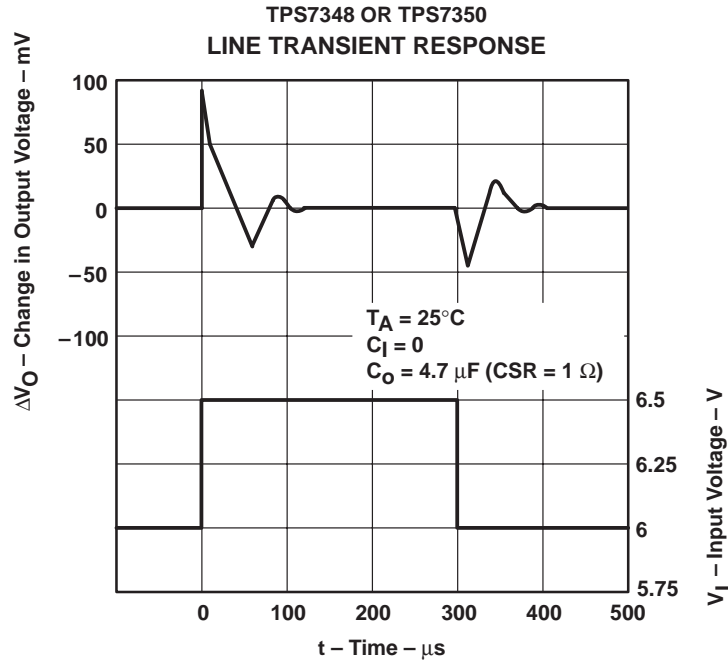

Figure 29

**TYPICAL CHARACTERISTICS**



**Figure 30**



**Figure 31**

TPS7301Q, TPS7325Q, TPS7330Q, TPS7333Q, TPS7348Q, TPS7350Q  
 LOW-DROPOUT VOLTAGE REGULATORS  
 WITH INTEGRATED DELAYED RESET FUNCTION

SLVS124F – JUNE 1995 – REVISED JANUARY 1999

TYPICAL CHARACTERISTICS

RIPPLE REJECTION  
 VS  
 FREQUENCY

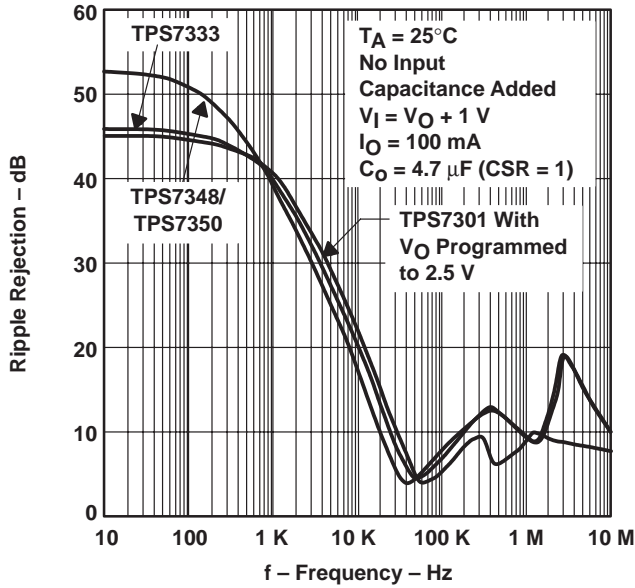

Figure 32

OUTPUT SPECTRAL-NOISE DENSITY  
 VS  
 FREQUENCY

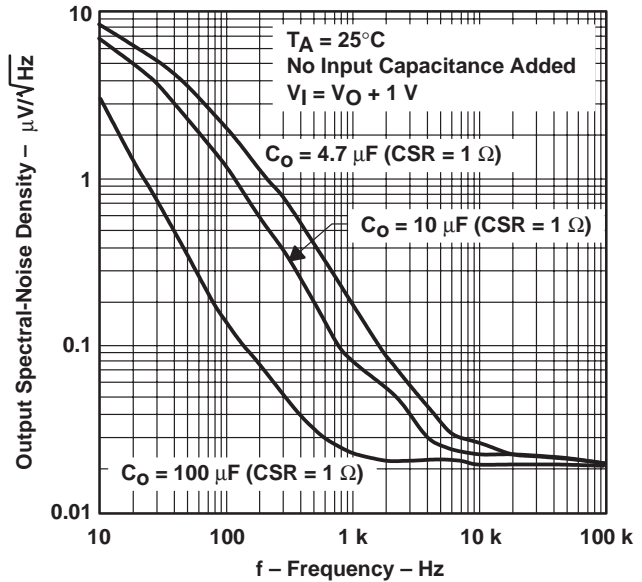

Figure 33

TYPICAL REGIONS OF STABILITY  
 COMPENSATION SERIES RESISTANCE (CSR)<sup>†</sup>  
 VS  
 OUTPUT CURRENT



Figure 34

TYPICAL REGIONS OF STABILITY  
 COMPENSATION SERIES RESISTANCE (CSR)<sup>†</sup>  
 VS  
 ADDED CERAMIC CAPACITANCE

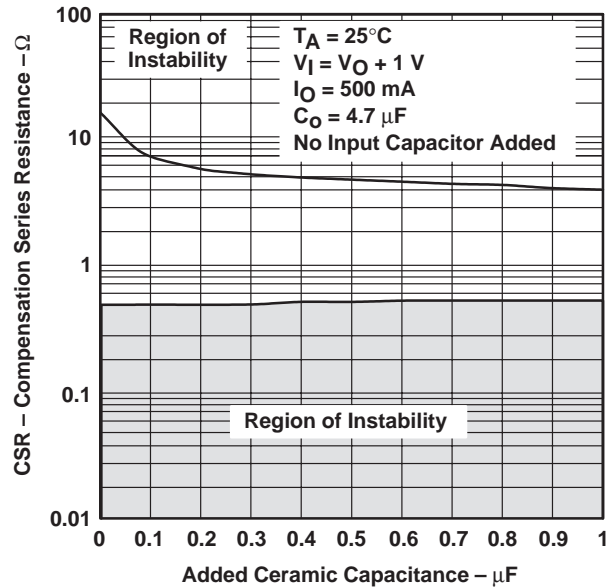

Figure 35



TYPICAL CHARACTERISTICS



Figure 36

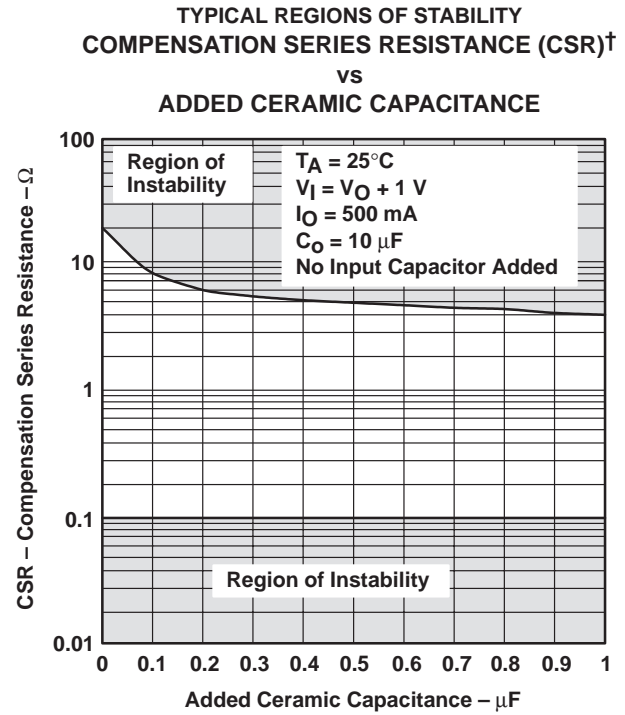

Figure 37

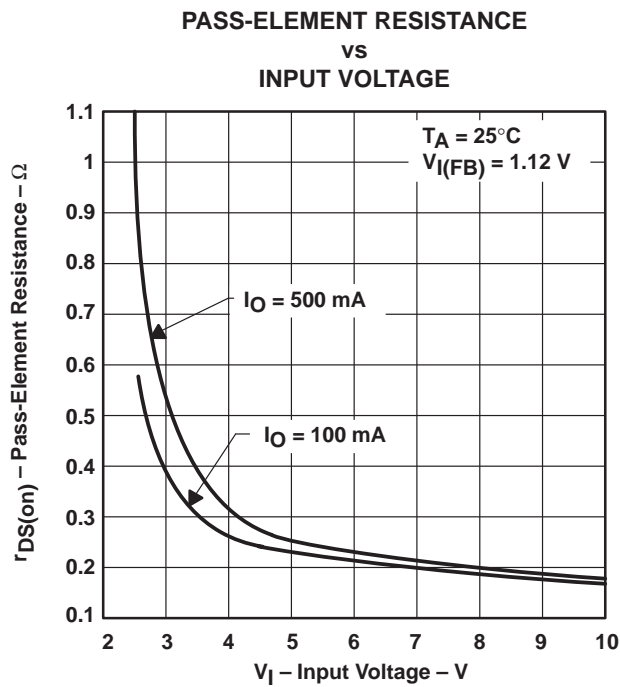

Figure 38

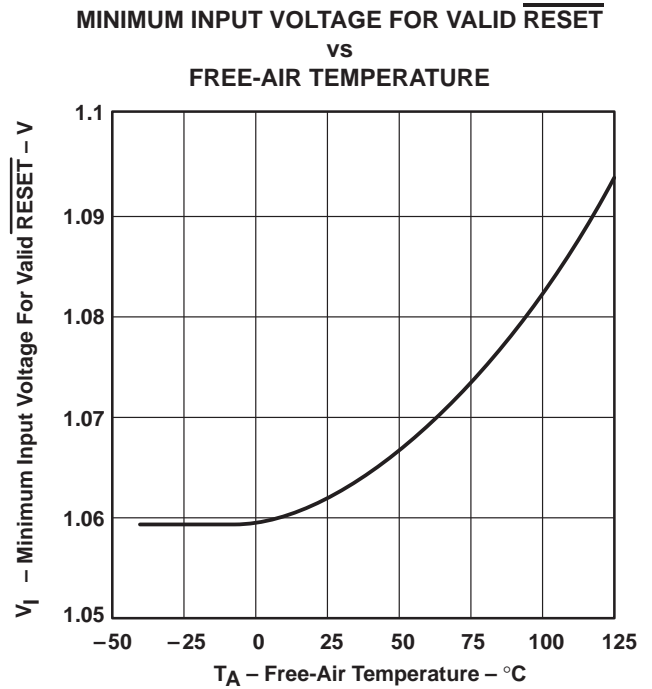

Figure 39

TPS7301Q, TPS7325Q, TPS7330Q, TPS7333Q, TPS7348Q, TPS7350Q  
 LOW-DROPOUT VOLTAGE REGULATORS  
 WITH INTEGRATED DELAYED RESET FUNCTION

SLVS124F – JUNE 1995 – REVISED JANUARY 1999

TYPICAL CHARACTERISTICS

NEGATIVE-GOING RESET THRESHOLD  
 vs  
 FREE-AIR TEMPERATURE



Figure 40

RESET OUTPUT CURRENT  
 vs  
 INPUT VOLTAGE

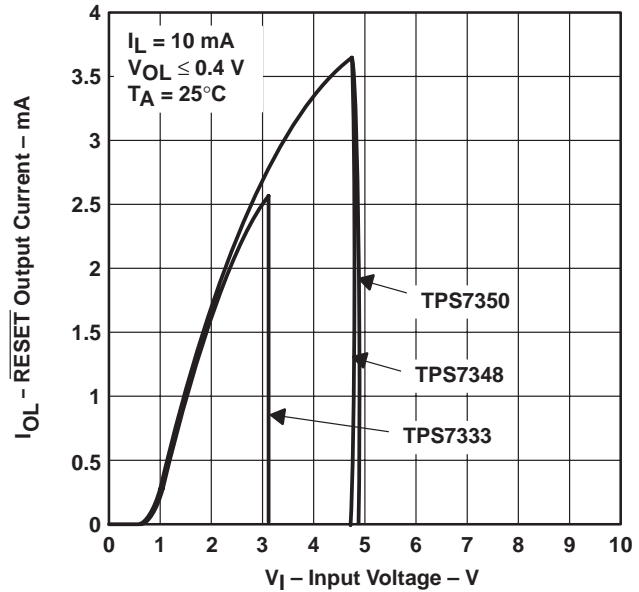

Figure 41

RESET DELAY TIME  
 vs  
 FREE-AIR TEMPERATURE



Figure 42

DISTRIBUTION FOR RESET DELAY

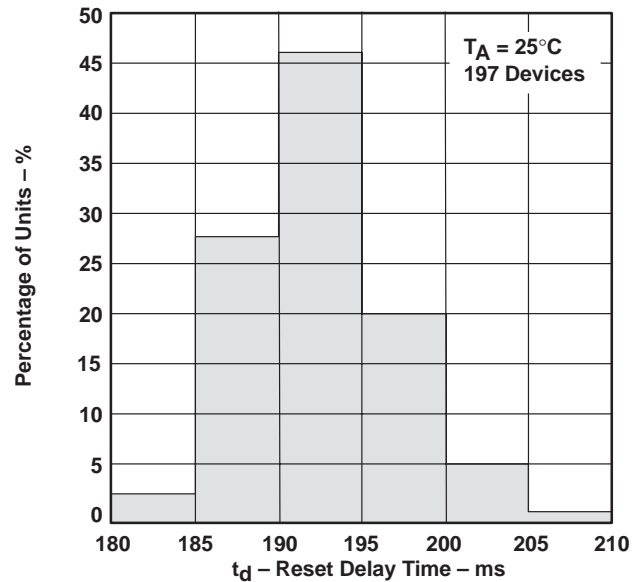

Figure 43



## THERMAL INFORMATION

In response to system-miniaturization trends, integrated circuits are being offered in low-profile and fine-pitch surface-mount packages. Implementation of many of today's high-performance devices in these packages requires special attention to power dissipation. Many system-dependent issues such as thermal coupling, airflow, added heat sinks and convection surfaces, and the presence of other heat-generating components affect the power-dissipation limits of a given component.

Three basic approaches for enhancing thermal performance are illustrated in this discussion:

- Improving the power-dissipation capability of the PWB design
- Improving the thermal coupling of the component to the PWB
- Introducing airflow in the system

Figure 44 is an example of a thermally enhanced PWB layout for the 20-lead TSSOP package. This layout involves adding copper on the PWB to conduct heat away from the device. The  $R_{\theta JA}$  (thermal resistance, junction-to-ambient) for this component/board system is illustrated in Figure 45. The family of curves illustrates the effect of increasing the size of the copper-heat-sink surface area. The PWB is a standard FR4 board ( $L \times W \times H = 3.2 \text{ inch} \times 3.2 \text{ inch} \times 0.062 \text{ inch}$ ); the board traces and heat sink area are 1-oz (per square foot) copper.

Figure 46 shows the thermal resistance for the same system with the addition of a thermally-conductive compound between the body of the TSSOP package and the PWB copper routed directly beneath the device. The thermal conductivity for the compound used in this analysis is  $0.815 \text{ W/m} \times ^\circ\text{C}$ .

Using these figures to determine the system  $R_{\theta JA}$  allows the maximum power-dissipation limit to be calculated with the equation:

$$P_{D(\max)} = \frac{T_{J(\max)} - T_A}{R_{\theta JA(\text{system})}}$$

Where

$T_{J(\max)}$  is the maximum allowable junction temperature;  $150^\circ\text{C}$  absolute maximum and  $125^\circ\text{C}$  maximum recommended operating temperature for specified operation.

This limit should then be applied to the internal power dissipated by the TPS73xx regulator. The equation for calculating total internal power dissipation of the TPS73xx is:

$$P_{D(\text{total})} = (V_I - V_O) \times I_O + V_I \times I_Q$$

Because the quiescent current of the TPS73xx family is very low, the second term is negligible, further simplifying the equation to:

$$P_{D(\text{total})} = (V_I - V_O) \times I_O$$

For a 20-lead TSSOP/FR4 board system with thermally conductive compound between the board and the device body, where  $T_A = 55^\circ\text{C}$ , airflow = 100 ft/min, and copper heat sink area =  $1 \text{ cm}^2$ , the maximum power-dissipation limit can be calculated. As indicated in Figure 46, the system  $R_{\theta JA}$  is  $94^\circ\text{C/W}$ ; therefore, the maximum power-dissipation limit is:

$$P_{D(\max)} = \frac{T_{J(\max)} - T_A}{R_{\theta JA(\text{system})}} = \frac{125^\circ\text{C} - 55^\circ\text{C}}{94^\circ\text{C/W}} = 745 \text{ mW}$$

If the system implements a TPS7348 regulator where  $V_I = 6 \text{ V}$  and  $I_O = 150 \text{ mA}$ , the internal power dissipation is:

$$P_{D(\text{total})} = (V_I - V_O) \times I_O = (6 - 4.85) \times 0.150 = 173 \text{ mW}$$

TPS7301Q, TPS7325Q, TPS7330Q, TPS7333Q, TPS7348Q, TPS7350Q  
**LOW-DROPOUT VOLTAGE REGULATORS**  
**WITH INTEGRATED DELAYED RESET FUNCTION**

SLVS124F – JUNE 1995 – REVISED JANUARY 1999

**THERMAL INFORMATION**

Comparing  $P_{D(total)}$  with  $P_{D(max)}$  reveals that the power dissipation in this example does not exceed the maximum limit. When it does, one of two corrective actions can be taken. The power-dissipation limit can be raised by increasing either the airflow or the heat-sink area. Alternatively, the internal power dissipation of the regulator can be lowered by reducing either the input voltage or the load current. In either case, the above calculations should be repeated with the new system parameters.

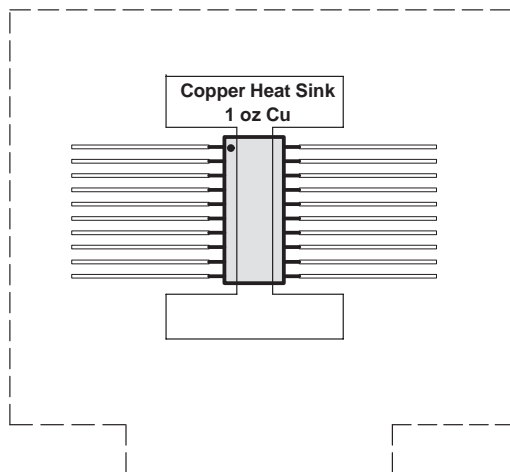

Figure 44. Thermally Enhanced PWB Layout (not to scale) for the 20-Pin TSSOP

THERMAL RESISTANCE, JUNCTION-TO-AMBIENT  
 VS  
 AIR FLOW

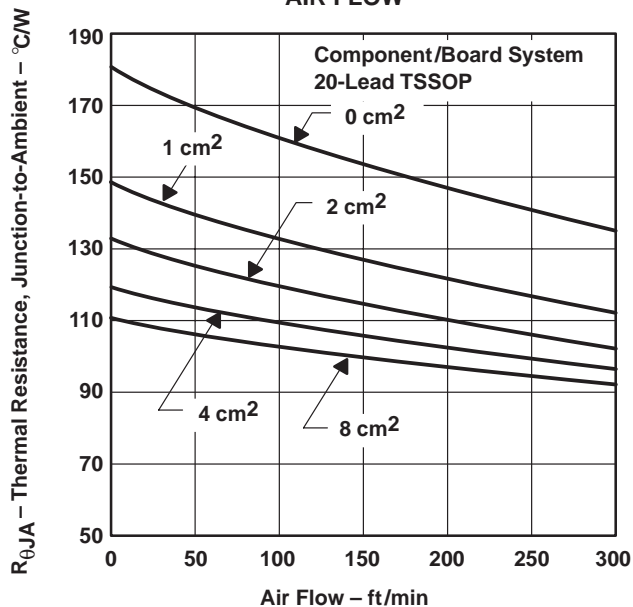

Figure 45

THERMAL RESISTANCE, JUNCTION-TO-AMBIENT  
 VS  
 AIR FLOW

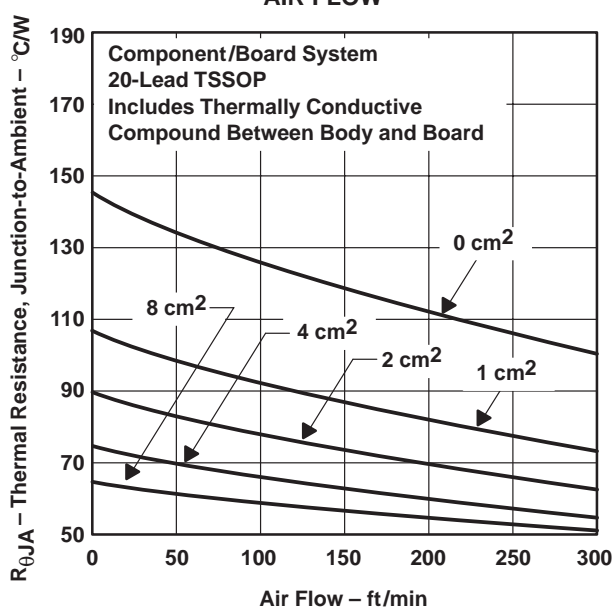

Figure 46

## APPLICATION INFORMATION

The TPS73xx series of low-dropout (LDO) regulators overcome many of the shortcomings of earlier generation LDOs, while adding features such as a power-saving shutdown mode and a supply-voltage supervisor. The TPS73xx family includes five fixed-output voltage regulators: the TPS7325 (2.5 V), TPS7330 (3 V), TPS7333 (3.3 V), the TPS7348 (4.85 V), and the TPS7350 (5 V). The family also offers an adjustable device, the TPS7301 (adjustable from 1.2 V to 9.75 V).

### device operation

The TPS73xx, unlike many other LDOs, features very low quiescent currents that remain virtually constant even with varying loads. Conventional LDO regulators use a pnp-pass element, the base current of which is directly proportional to the load current through the regulator ( $I_B = I_C/\beta$ ). Close examination of the data sheets reveals that such devices are typically specified under near no-load conditions; actual operating currents are much higher as evidenced by typical quiescent current versus load current curves (see Figure 7). The TPS73xx uses a PMOS transistor to pass current; because the gate of the PMOS element is voltage driven, operating currents are low and invariable over the full load range. The TPS73xx specifications reflect actual performance under load.

Another pitfall associated with the pnp-pass element is its tendency to saturate when the device goes into dropout. The resulting drop in  $\beta$  forces an increase in  $I_B$  to maintain the load. During power-up, this translates to large start-up currents. Systems with limited supply current may fail to start up. In battery-powered systems, it means rapid battery discharge when the voltage decays below the minimum required for regulation. The TPS73xx quiescent current remains low even when the regulator drops out, thus eliminating both problems.

Included in the TPS73xx family is a 4.85-V regulator, the TPS7348. Designed specifically for 5-V cellular systems, its 4.85-V output, regulated to within  $\pm 2\%$ , allows for operation within the low-end limit of 5-V systems specified to  $\pm 5\%$  tolerance; therefore, maximum regulated operating lifetime is obtained from a battery pack before the device drops out, adding crucial talk minutes between charges.

The TPS73xx family also features a shutdown mode that places the output in the high-impedance state (essentially equal to the feedback-divider resistance) and reduces quiescent current to under  $0.5 \mu\text{A}$ . When the shutdown feature is not used,  $\overline{\text{EN}}$  should be tied to ground. Response to an enable transition is quick; regulated output voltage is reestablished in typically  $120 \mu\text{s}$ .

### minimum load requirements

The TPS73xx family is stable even at zero load; no minimum load is required for operation.

### SENSE connection

The SENSE terminal of fixed-output devices must be connected to the regulator output for proper functioning of the regulator. Normally, this connection should be as short as possible; however, the connection can be made near a critical circuit (remote sense) to improve performance at that point. Internally, SENSE connects to a high-impedance wide-bandwidth amplifier through a resistor-divider network, and noise pickup feeds through to the regulator output. It is essential to route the SENSE connection in such a way as to minimize/avoid noise pickup. Adding an RC network between SENSE and OUT to filter noise is not recommended because it can cause the regulator to oscillate.

### external capacitor requirements

An input capacitor is not required; however, a ceramic bypass capacitor ( $0.047 \mu\text{F}$  to  $0.1 \mu\text{F}$ ) improves load transient response and noise rejection when the TPS73xx is located more than a few inches from the power supply. A higher-capacitance electrolytic capacitor may be necessary if large (hundreds of milliamps) load transients with fast rise times are anticipated.

**TPS7301Q, TPS7325Q, TPS7330Q, TPS7333Q, TPS7348Q, TPS7350Q**  
**LOW-DROPOUT VOLTAGE REGULATORS**  
**WITH INTEGRATED DELAYED RESET FUNCTION**

SLVS124F – JUNE 1995 – REVISED JANUARY 1999

**APPLICATION INFORMATION**

**external capacitor requirements (continued)**

As with most LDO regulators, the TPS73xx family requires an output capacitor for stability. A low-ESR 10- $\mu$ F solid-tantalum capacitor connected from the regulator output to ground is sufficient to ensure stability over the full load range (see Figure 42). Adding high-frequency ceramic or film capacitors (such as power-supply bypass capacitors for digital or analog ICs) can cause the regulator to become unstable unless the ESR of the tantalum capacitor is less than 1.2  $\Omega$  over temperature. Capacitors with published ESR specifications such as the AVX TPSD106M035R0300 and the Sprague 593D106X0035D2W work well because the maximum ESR at 25°C is 300 m $\Omega$  (typically, the ESR in solid-tantalum capacitors increases by a factor of 2 or less when the temperature drops from 25°C to -40°C). Where component height and/or mounting area is a problem, physically smaller, 10- $\mu$ F devices can be screened for ESR. Figures 29 through 32 show the stable regions of operation using different values of output capacitance with various values of ceramic load capacitance.

In applications with little or no high-frequency bypass capacitance (< 0.2  $\mu$ F), the output capacitance can be reduced to 4.7  $\mu$ F, provided ESR is maintained between 0.7 and 2.5  $\Omega$ . Because capacitor minimum ESR is seldom if ever specified, it may be necessary to add a 0.5- $\Omega$  to 1- $\Omega$  resistor in series with the capacitor and limit ESR to 1.5  $\Omega$  maximum. As shown in the CSR graphs (Figures 29 through 32), minimum ESR is not a problem when using 10- $\mu$ F or larger output capacitors.

Below is a partial listing of surface-mount capacitors usable with the TPS73xx family. This information, along with the CSR graphs, is included to assist in selection of suitable capacitance for the user's application. When necessary to achieve low height requirements along with high output current and/or high ceramic load capacitance, several higher ESR capacitors can be used in parallel to meet the guidelines above.

All load and temperature conditions with up to 1  $\mu$ F of added ceramic load capacitance:

PART NO.	MFR.	VALUE	MAX ESR†	SIZE (H × L × W)†
T421C226M010AS	Kemet	22 $\mu$ F, 10 V	0.5	2.8 × 6 × 3.2
593D156X0025D2W	Sprague	15 $\mu$ F, 25 V	0.3	2.8 × 7.3 × 4.3
593D106X0035D2W	Sprague	10 $\mu$ F, 35 V	0.3	2.8 × 7.3 × 4.3
TPSD106M035R0300	AVX	10 $\mu$ F, 35 V	0.3	2.8 × 7.3 × 4.3

Load < 200 mA, ceramic load capacitance < 0.2  $\mu$ F, full temperature range:

PART NO.	MFR.	VALUE	MAX ESR†	SIZE (H × L × W)†
592D156X0020R2T	Sprague	15 $\mu$ F, 20 V	1.1	1.2 × 7.2 × 6
595D156X0025C2T	Sprague	15 $\mu$ F, 25 V	1	2.5 × 7.1 × 3.2
595D106X0025C2T	Sprague	10 $\mu$ F, 25 V	1.2	2.5 × 7.1 × 3.2
293D226X0016D2W	Sprague	22 $\mu$ F, 16 V	1.1	2.8 × 7.3 × 4.3

Load < 100 mA, ceramic load capacitance < 0.2  $\mu$ F, full temperature range:

PART NO.	MFR.	VALUE	MAX ESR†	SIZE (H × L × W)†
195D106X06R3V2T	Sprague	10 $\mu$ F, 6.3 V	1.5	1.3 × 3.5 × 2.7
195D106X0016X2T	Sprague	10 $\mu$ F, 16 V	1.5	1.3 × 7 × 2.7
595D156X0016B2T	Sprague	15 $\mu$ F, 16 V	1.8	1.6 × 3.8 × 2.6
695D226X0015F2T	Sprague	22 $\mu$ F, 15 V	1.4	1.8 × 6.5 × 3.4
695D156X0020F2T	Sprague	15 $\mu$ F, 20 V	1.5	1.8 × 6.5 × 3.4
695D106X0035G2T	Sprague	10 $\mu$ F, 35 V	1.3	2.5 × 7.6 × 2.5

† Size is in mm. ESR is maximum resistance at 100 kHz and T<sub>A</sub> = 25°C. Listings are sorted by height.



APPLICATION INFORMATION

external capacitor requirements (continued)

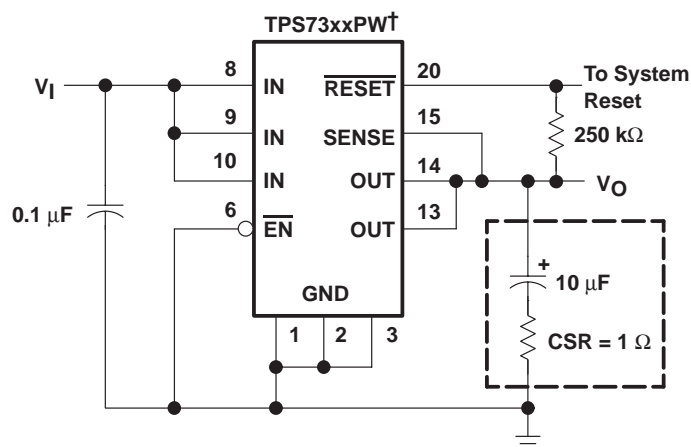

† TPS7333, TPS7348, TPS7350 (fixed-voltage options)

Figure 47. Typical Application Circuit

programming the TPS7301 adjustable LDO regulator

Programming the adjustable regulators is accomplished using an external resistor divider as shown in Figure 43. The equation governing the output voltage is:

$$V_O = V_{\text{ref}} \times \left(1 + \frac{R1}{R2}\right)$$

Where

$V_{\text{ref}}$  = reference voltage, 1.182 V typ

**TPS7301Q, TPS7325Q, TPS7330Q, TPS7333Q, TPS7348Q, TPS7350Q**  
**LOW-DROPOUT VOLTAGE REGULATORS**  
**WITH INTEGRATED DELAYED RESET FUNCTION**

SLVS124F – JUNE 1995 – REVISED JANUARY 1999

**APPLICATION INFORMATION**

Resistors R1 and R2 should be chosen for approximately 7- $\mu$ A divider current. A recommended value for R2 is 169 k $\Omega$  with R1 adjusted for the desired output voltage. Smaller resistors can be used, but offer no inherent advantage and consume more power. Larger values of R1 and R2 should be avoided as leakage currents at FB will introduce an error. Solving for R1 yields a more useful equation for choosing the appropriate resistance:

$$R1 = \left( \frac{V_O}{V_{ref}} - 1 \right) \times R2$$



**Figure 48. TPS7301 Adjustable LDO Regulator Programming**

**undervoltage supervisor function**

The  $\overline{\text{RESET}}$  output of the TPS73xx initiates a reset in microcomputer and microprocessor systems in the event of an undervoltage condition. An internal comparator in the TPS73xx monitors the output voltage of the regulator to detect the undervoltage condition. When that occurs, the  $\overline{\text{RESET}}$  output transistor turns on taking the  $\overline{\text{RESET}}$  signal low.

On power up, the output voltage tracks the input voltage. The  $\overline{\text{RESET}}$  output becomes active (low) as  $V_I$  approaches the minimum required for a valid  $\overline{\text{RESET}}$  signal (specified at 1.5 V for 25°C and 1.9 V over full recommended operating temperature range). When the output voltage reaches the appropriate positive-going input threshold ( $V_{IT+}$ ), a 200-ms (typical) timeout period begins during which the  $\overline{\text{RESET}}$  output remains low. Once the timeout has expired, the  $\overline{\text{RESET}}$  output becomes inactive. Since the  $\overline{\text{RESET}}$  output is an open-drain NMOS, a pullup resistor should be used to ensure that a logic-high signal is indicated.

The supply-voltage-supervisor function is also activated during power-down. As the input voltage decays and after the dropout voltage is reached, the output voltage tracks linearly with the decaying input voltage. When the output voltage drops below the specified negative-going input threshold ( $V_{IT-}$  — see electrical characteristics tables), the  $\overline{\text{RESET}}$  output becomes active (low). It is important to note that if the input voltage decays below the minimum required for a valid  $\overline{\text{RESET}}$ , the  $\overline{\text{RESET}}$  is undefined.

Since the circuit is monitoring the regulator output voltage, the  $\overline{\text{RESET}}$  output can also be triggered by disabling the regulator or by any fault condition that causes the output to drop below  $V_{IT-}$ . Examples of fault conditions include a short circuit on the output and a low input voltage. Once the output voltage is reestablished, either by reenabling the regulator or removing the fault condition, then the internal timer is initiated, which holds the  $\overline{\text{RESET}}$  signal active during the 200-ms (typical) timeout period.



---

## APPLICATION INFORMATION

### undervoltage supervisor function (continued)

Transient loads or line pulses can also cause a reset to occur if proper care is not taken in selecting the input and output capacitors. Load transients that are faster than 5  $\mu\text{s}$  can cause a reset if high-ESR output capacitors (greater than approximately 7  $\Omega$ ) are used. A 1- $\mu\text{s}$  transient causes a reset when using an output capacitor with greater than 3.5  $\Omega$  of ESR. Note that the output-voltage spike during the transient can drop well below the reset threshold and still not trip if the transient duration is short. A 1- $\mu\text{s}$  transient must drop at least 500 mV below the threshold before tripping the reset circuit. A 2- $\mu\text{s}$  transient trips RESET at just 400 mV below the threshold. Lower-ESR output capacitors help by reducing the drop in output voltage during a transient and should be used when fast transients are expected.

**NOTE:**

$$V_{IT+} = V_{IT-} + \text{Hysteresis}$$

### output noise

The TPS73xx has very low output noise, with a spectral noise density  $< 2 \mu\text{V}/\sqrt{\text{Hz}}$ . This is important when noise-susceptible systems, such as audio amplifiers, are powered by the regulator.

### regulator protection

The TPS73xx PMOS-pass transistor has a built-in back diode that safely conducts reverse currents when the input voltage drops below the output voltage (e.g., during power down). Current is conducted from the output to the input and is not internally limited. If extended reverse voltage is anticipated, external limiting might be appropriate.

The TPS73xx also features internal current limiting and thermal protection. During normal operation, the TPS73xx limits output current to approximately 1 A. When current limiting engages, the output voltage scales back linearly until the overcurrent condition ends. While current limiting is designed to prevent gross device failure, care should be taken not to exceed the power dissipation ratings of the package. If the temperature of the device exceeds 165°C, thermal-protection circuitry shuts it down. Once the device has cooled, regulator operation resumes.

**PACKAGING INFORMATION**

Orderable Device	Status <sup>(1)</sup>	Package Type	Package Drawing	Pins	Package Qty	Eco Plan <sup>(2)</sup>	Lead/Ball Finish	MSL Peak Temp <sup>(3)</sup>
TPS7301QD	ACTIVE	SOIC	D	8	75	Green (RoHS & no Sb/Br)	CU NIPDAU	Level-1-260C-UNLIM
TPS7301QDG4	ACTIVE	SOIC	D	8	75	Green (RoHS & no Sb/Br)	CU NIPDAU	Level-1-260C-UNLIM
TPS7301QDR	ACTIVE	SOIC	D	8	2500	Green (RoHS & no Sb/Br)	CU NIPDAU	Level-1-260C-UNLIM
TPS7301QDRG4	ACTIVE	SOIC	D	8	2500	Green (RoHS & no Sb/Br)	CU NIPDAU	Level-1-260C-UNLIM
TPS7301QP	ACTIVE	PDIP	P	8	50	Pb-Free (RoHS)	CU NIPDAU	N / A for Pkg Type
TPS7301QPE4	ACTIVE	PDIP	P	8	50	Pb-Free (RoHS)	CU NIPDAU	N / A for Pkg Type
TPS7301QPW	ACTIVE	TSSOP	PW	20	70	Green (RoHS & no Sb/Br)	CU NIPDAU	Level-1-260C-UNLIM
TPS7301QPWG4	ACTIVE	TSSOP	PW	20	70	Green (RoHS & no Sb/Br)	CU NIPDAU	Level-1-260C-UNLIM
TPS7301QPWLE	OBSOLETE	TSSOP	PW	20		TBD	Call TI	Call TI
TPS7301QPWR	ACTIVE	TSSOP	PW	20	2000	Green (RoHS & no Sb/Br)	CU NIPDAU	Level-1-260C-UNLIM
TPS7301QPWRG4	ACTIVE	TSSOP	PW	20	2000	Green (RoHS & no Sb/Br)	CU NIPDAU	Level-1-260C-UNLIM
TPS7325QD	ACTIVE	SOIC	D	8	75	Green (RoHS & no Sb/Br)	CU NIPDAU	Level-1-260C-UNLIM
TPS7325QDG4	ACTIVE	SOIC	D	8	75	Green (RoHS & no Sb/Br)	CU NIPDAU	Level-1-260C-UNLIM
TPS7325QP	ACTIVE	PDIP	P	8	50	Pb-Free (RoHS)	CU NIPDAU	N / A for Pkg Type
TPS7325QPE4	ACTIVE	PDIP	P	8	50	Pb-Free (RoHS)	CU NIPDAU	N / A for Pkg Type
TPS7325QPW	ACTIVE	TSSOP	PW	20	70	Green (RoHS & no Sb/Br)	CU NIPDAU	Level-1-260C-UNLIM
TPS7325QPWG4	ACTIVE	TSSOP	PW	20	70	Green (RoHS & no Sb/Br)	CU NIPDAU	Level-1-260C-UNLIM
TPS7325QPWR	ACTIVE	TSSOP	PW	20	2000	Green (RoHS & no Sb/Br)	CU NIPDAU	Level-1-260C-UNLIM
TPS7325QPWRG4	ACTIVE	TSSOP	PW	20	2000	Green (RoHS & no Sb/Br)	CU NIPDAU	Level-1-260C-UNLIM
TPS7330QD	ACTIVE	SOIC	D	8	75	Green (RoHS & no Sb/Br)	CU NIPDAU	Level-1-260C-UNLIM
TPS7330QDG4	ACTIVE	SOIC	D	8	75	Green (RoHS & no Sb/Br)	CU NIPDAU	Level-1-260C-UNLIM
TPS7330QDR	ACTIVE	SOIC	D	8	2500	Green (RoHS & no Sb/Br)	CU NIPDAU	Level-1-260C-UNLIM
TPS7330QDRG4	ACTIVE	SOIC	D	8	2500	Green (RoHS & no Sb/Br)	CU NIPDAU	Level-1-260C-UNLIM
TPS7330QP	ACTIVE	PDIP	P	8	50	Pb-Free (RoHS)	CU NIPDAU	N / A for Pkg Type
TPS7330QPE4	ACTIVE	PDIP	P	8	50	Pb-Free (RoHS)	CU NIPDAU	N / A for Pkg Type



Orderable Device	Status <sup>(1)</sup>	Package Type	Package Drawing	Pins	Package Qty	Eco Plan <sup>(2)</sup>	Lead/Ball Finish	MSL Peak Temp <sup>(3)</sup>
TPS7330QPWR	ACTIVE	TSSOP	PW	20	2000	Green (RoHS & no Sb/Br)	CU NIPDAU	Level-1-260C-UNLIM
TPS7330QPWRG4	ACTIVE	TSSOP	PW	20	2000	Green (RoHS & no Sb/Br)	CU NIPDAU	Level-1-260C-UNLIM
TPS7333QD	ACTIVE	SOIC	D	8	75	Green (RoHS & no Sb/Br)	CU NIPDAU	Level-1-260C-UNLIM
TPS7333QDG4	ACTIVE	SOIC	D	8	75	Green (RoHS & no Sb/Br)	CU NIPDAU	Level-1-260C-UNLIM
TPS7333QDR	ACTIVE	SOIC	D	8	2500	Green (RoHS & no Sb/Br)	CU NIPDAU	Level-1-260C-UNLIM
TPS7333QDRG4	ACTIVE	SOIC	D	8	2500	Green (RoHS & no Sb/Br)	CU NIPDAU	Level-1-260C-UNLIM
TPS7333QP	ACTIVE	PDIP	P	8	50	Pb-Free (RoHS)	CU NIPDAU	N / A for Pkg Type
TPS7333QPE4	ACTIVE	PDIP	P	8	50	Pb-Free (RoHS)	CU NIPDAU	N / A for Pkg Type
TPS7333QPW	ACTIVE	TSSOP	PW	20	70	Green (RoHS & no Sb/Br)	CU NIPDAU	Level-1-260C-UNLIM
TPS7333QPWG4	ACTIVE	TSSOP	PW	20	70	Green (RoHS & no Sb/Br)	CU NIPDAU	Level-1-260C-UNLIM
TPS7333QPWLE	OBSOLETE	TSSOP	PW	20		TBD	Call TI	Call TI
TPS7333QPWR	ACTIVE	TSSOP	PW	20	2000	Green (RoHS & no Sb/Br)	CU NIPDAU	Level-1-260C-UNLIM
TPS7333QPWRG4	ACTIVE	TSSOP	PW	20	2000	Green (RoHS & no Sb/Br)	CU NIPDAU	Level-1-260C-UNLIM
TPS7348QD	ACTIVE	SOIC	D	8	75	Green (RoHS & no Sb/Br)	CU NIPDAU	Level-1-260C-UNLIM
TPS7348QDG4	ACTIVE	SOIC	D	8	75	Green (RoHS & no Sb/Br)	CU NIPDAU	Level-1-260C-UNLIM
TPS7348QDR	ACTIVE	SOIC	D	8	2500	Green (RoHS & no Sb/Br)	CU NIPDAU	Level-1-260C-UNLIM
TPS7348QDRG4	ACTIVE	SOIC	D	8	2500	Green (RoHS & no Sb/Br)	CU NIPDAU	Level-1-260C-UNLIM
TPS7348QP	ACTIVE	PDIP	P	8	50	Pb-Free (RoHS)	CU NIPDAU	N / A for Pkg Type
TPS7348QPE4	ACTIVE	PDIP	P	8	50	Pb-Free (RoHS)	CU NIPDAU	N / A for Pkg Type
TPS7348QPWLE	OBSOLETE	TSSOP	PW	20		TBD	Call TI	Call TI
TPS7350QD	ACTIVE	SOIC	D	8	75	Green (RoHS & no Sb/Br)	CU NIPDAU	Level-1-260C-UNLIM
TPS7350QDG4	ACTIVE	SOIC	D	8	75	Green (RoHS & no Sb/Br)	CU NIPDAU	Level-1-260C-UNLIM
TPS7350QDR	ACTIVE	SOIC	D	8	2500	Green (RoHS & no Sb/Br)	CU NIPDAU	Level-1-260C-UNLIM
TPS7350QDRG4	ACTIVE	SOIC	D	8	2500	Green (RoHS & no Sb/Br)	CU NIPDAU	Level-1-260C-UNLIM
TPS7350QP	ACTIVE	PDIP	P	8	50	Pb-Free (RoHS)	CU NIPDAU	N / A for Pkg Type
TPS7350QPE4	ACTIVE	PDIP	P	8	50	Pb-Free (RoHS)	CU NIPDAU	N / A for Pkg Type
TPS7350QPWLE	OBSOLETE	TSSOP	PW	20		TBD	Call TI	Call TI

Orderable Device	Status <sup>(1)</sup>	Package Type	Package Drawing	Pins	Package Qty	Eco Plan <sup>(2)</sup>	Lead/Ball Finish	MSL Peak Temp <sup>(3)</sup>
TPS7350QPWR	ACTIVE	TSSOP	PW	20	2000	Green (RoHS & no Sb/Br)	CU NIPDAU	Level-1-260C-UNLIM
TPS7350QPWRG4	ACTIVE	TSSOP	PW	20	2000	Green (RoHS & no Sb/Br)	CU NIPDAU	Level-1-260C-UNLIM

<sup>(1)</sup> The marketing status values are defined as follows:

**ACTIVE:** Product device recommended for new designs.

**LIFEBUY:** TI has announced that the device will be discontinued, and a lifetime-buy period is in effect.

**NRND:** Not recommended for new designs. Device is in production to support existing customers, but TI does not recommend using this part in a new design.

**PREVIEW:** Device has been announced but is not in production. Samples may or may not be available.

**OBSOLETE:** TI has discontinued the production of the device.

<sup>(2)</sup> Eco Plan - The planned eco-friendly classification: Pb-Free (RoHS), Pb-Free (RoHS Exempt), or Green (RoHS & no Sb/Br) - please check <http://www.ti.com/productcontent> for the latest availability information and additional product content details.

**TBD:** The Pb-Free/Green conversion plan has not been defined.

**Pb-Free (RoHS):** TI's terms "Lead-Free" or "Pb-Free" mean semiconductor products that are compatible with the current RoHS requirements for all 6 substances, including the requirement that lead not exceed 0.1% by weight in homogeneous materials. Where designed to be soldered at high temperatures, TI Pb-Free products are suitable for use in specified lead-free processes.

**Pb-Free (RoHS Exempt):** This component has a RoHS exemption for either 1) lead-based flip-chip solder bumps used between the die and package, or 2) lead-based die adhesive used between the die and leadframe. The component is otherwise considered Pb-Free (RoHS compatible) as defined above.

**Green (RoHS & no Sb/Br):** TI defines "Green" to mean Pb-Free (RoHS compatible), and free of Bromine (Br) and Antimony (Sb) based flame retardants (Br or Sb do not exceed 0.1% by weight in homogeneous material)

<sup>(3)</sup> MSL, Peak Temp. -- The Moisture Sensitivity Level rating according to the JEDEC industry standard classifications, and peak solder temperature.

**Important Information and Disclaimer:** The information provided on this page represents TI's knowledge and belief as of the date that it is provided. TI bases its knowledge and belief on information provided by third parties, and makes no representation or warranty as to the accuracy of such information. Efforts are underway to better integrate information from third parties. TI has taken and continues to take reasonable steps to provide representative and accurate information but may not have conducted destructive testing or chemical analysis on incoming materials and chemicals. TI and TI suppliers consider certain information to be proprietary, and thus CAS numbers and other limited information may not be available for release.

In no event shall TI's liability arising out of such information exceed the total purchase price of the TI part(s) at issue in this document sold by TI to Customer on an annual basis.

**TAPE AND REEL INFORMATION**
**REEL DIMENSIONS**

**TAPE DIMENSIONS**

A0	Dimension designed to accommodate the component width
B0	Dimension designed to accommodate the component length
K0	Dimension designed to accommodate the component thickness
W	Overall width of the carrier tape
P1	Pitch between successive cavity centers

**TAPE AND REEL INFORMATION**

\*All dimensions are nominal

Device	Package Type	Package Drawing	Pins	SPQ	Reel Diameter (mm)	Reel Width W1 (mm)	A0 (mm)	B0 (mm)	K0 (mm)	P1 (mm)	W (mm)	Pin1 Quadrant
TPS7301QDR	SOIC	D	8	2500	330.0	12.4	6.4	5.2	2.1	8.0	12.0	Q1
TPS7301QPWR	TSSOP	PW	20	2000	330.0	16.4	6.95	7.1	1.6	8.0	16.0	Q1
TPS7325QPWR	TSSOP	PW	20	2000	330.0	16.4	6.95	7.1	1.6	8.0	16.0	Q1
TPS7330QDR	SOIC	D	8	2500	330.0	12.4	6.4	5.2	2.1	8.0	12.0	Q1
TPS7330QPWR	TSSOP	PW	20	2000	330.0	16.4	6.95	7.1	1.6	8.0	16.0	Q1
TPS7333QDR	SOIC	D	8	2500	330.0	12.4	6.4	5.2	2.1	8.0	12.0	Q1
TPS7333QPWR	TSSOP	PW	20	2000	330.0	16.4	6.95	7.1	1.6	8.0	16.0	Q1
TPS7348QDR	SOIC	D	8	2500	330.0	12.4	6.4	5.2	2.1	8.0	12.0	Q1
TPS7350QDR	SOIC	D	8	2500	330.0	12.4	6.4	5.2	2.1	8.0	12.0	Q1
TPS7350QPWR	TSSOP	PW	20	2000	330.0	16.4	6.95	7.1	1.6	8.0	16.0	Q1

**TAPE AND REEL BOX DIMENSIONS**

\*All dimensions are nominal

Device	Package Type	Package Drawing	Pins	SPQ	Length (mm)	Width (mm)	Height (mm)
TPS7301QDR	SOIC	D	8	2500	367.0	367.0	35.0
TPS7301QPWR	TSSOP	PW	20	2000	367.0	367.0	38.0
TPS7325QPWR	TSSOP	PW	20	2000	367.0	367.0	38.0
TPS7330QDR	SOIC	D	8	2500	367.0	367.0	35.0
TPS7330QPWR	TSSOP	PW	20	2000	367.0	367.0	38.0
TPS7333QDR	SOIC	D	8	2500	367.0	367.0	35.0
TPS7333QPWR	TSSOP	PW	20	2000	367.0	367.0	38.0
TPS7348QDR	SOIC	D	8	2500	367.0	367.0	35.0
TPS7350QDR	SOIC	D	8	2500	367.0	367.0	35.0
TPS7350QPWR	TSSOP	PW	20	2000	367.0	367.0	38.0

## IMPORTANT NOTICE

Texas Instruments Incorporated and its subsidiaries (TI) reserve the right to make corrections, enhancements, improvements and other changes to its semiconductor products and services per JESD46C and to discontinue any product or service per JESD48B. Buyers should obtain the latest relevant information before placing orders and should verify that such information is current and complete. All semiconductor products (also referred to herein as "components") are sold subject to TI's terms and conditions of sale supplied at the time of order acknowledgment.

TI warrants performance of its components to the specifications applicable at the time of sale, in accordance with the warranty in TI's terms and conditions of sale of semiconductor products. Testing and other quality control techniques are used to the extent TI deems necessary to support this warranty. Except where mandated by applicable law, testing of all parameters of each component is not necessarily performed.

TI assumes no liability for applications assistance or the design of Buyers' products. Buyers are responsible for their products and applications using TI components. To minimize the risks associated with Buyers' products and applications, Buyers should provide adequate design and operating safeguards.

TI does not warrant or represent that any license, either express or implied, is granted under any patent right, copyright, mask work right, or other intellectual property right relating to any combination, machine, or process in which TI components or services are used. Information published by TI regarding third-party products or services does not constitute a license to use such products or services or a warranty or endorsement thereof. Use of such information may require a license from a third party under the patents or other intellectual property of the third party, or a license from TI under the patents or other intellectual property of TI.

Reproduction of significant portions of TI information in TI data books or data sheets is permissible only if reproduction is without alteration and is accompanied by all associated warranties, conditions, limitations, and notices. TI is not responsible or liable for such altered documentation. Information of third parties may be subject to additional restrictions.

Resale of TI components or services with statements different from or beyond the parameters stated by TI for that component or service voids all express and any implied warranties for the associated TI component or service and is an unfair and deceptive business practice. TI is not responsible or liable for any such statements.

Buyer acknowledges and agrees that it is solely responsible for compliance with all legal, regulatory and safety-related requirements concerning its products, and any use of TI components in its applications, notwithstanding any applications-related information or support that may be provided by TI. Buyer represents and agrees that it has all the necessary expertise to create and implement safeguards which anticipate dangerous consequences of failures, monitor failures and their consequences, lessen the likelihood of failures that might cause harm and take appropriate remedial actions. Buyer will fully indemnify TI and its representatives against any damages arising out of the use of any TI components in safety-critical applications.

In some cases, TI components may be promoted specifically to facilitate safety-related applications. With such components, TI's goal is to help enable customers to design and create their own end-product solutions that meet applicable functional safety standards and requirements. Nonetheless, such components are subject to these terms.

No TI components are authorized for use in FDA Class III (or similar life-critical medical equipment) unless authorized officers of the parties have executed a special agreement specifically governing such use.

Only those TI components which TI has specifically designated as military grade or "enhanced plastic" are designed and intended for use in military/aerospace applications or environments. Buyer acknowledges and agrees that any military or aerospace use of TI components which have **not** been so designated is solely at the Buyer's risk, and that Buyer is solely responsible for compliance with all legal and regulatory requirements in connection with such use.

TI has specifically designated certain components which meet ISO/TS16949 requirements, mainly for automotive use. Components which have not been so designated are neither designed nor intended for automotive use; and TI will not be responsible for any failure of such components to meet such requirements.

### Products

Audio	<a href="http://www.ti.com/audio">www.ti.com/audio</a>
Amplifiers	<a href="http://amplifier.ti.com">amplifier.ti.com</a>
Data Converters	<a href="http://dataconverter.ti.com">dataconverter.ti.com</a>
DLP® Products	<a href="http://www.dlp.com">www.dlp.com</a>
DSP	<a href="http://dsp.ti.com">dsp.ti.com</a>
Clocks and Timers	<a href="http://www.ti.com/clocks">www.ti.com/clocks</a>
Interface	<a href="http://interface.ti.com">interface.ti.com</a>
Logic	<a href="http://logic.ti.com">logic.ti.com</a>
Power Mgmt	<a href="http://power.ti.com">power.ti.com</a>
Microcontrollers	<a href="http://microcontroller.ti.com">microcontroller.ti.com</a>
RFID	<a href="http://www.ti-rfid.com">www.ti-rfid.com</a>
OMAP Mobile Processors	<a href="http://www.ti.com/omap">www.ti.com/omap</a>
Wireless Connectivity	<a href="http://www.ti.com/wirelessconnectivity">www.ti.com/wirelessconnectivity</a>

### Applications

Automotive and Transportation	<a href="http://www.ti.com/automotive">www.ti.com/automotive</a>
Communications and Telecom	<a href="http://www.ti.com/communications">www.ti.com/communications</a>
Computers and Peripherals	<a href="http://www.ti.com/computers">www.ti.com/computers</a>
Consumer Electronics	<a href="http://www.ti.com/consumer-apps">www.ti.com/consumer-apps</a>
Energy and Lighting	<a href="http://www.ti.com/energy">www.ti.com/energy</a>
Industrial	<a href="http://www.ti.com/industrial">www.ti.com/industrial</a>
Medical	<a href="http://www.ti.com/medical">www.ti.com/medical</a>
Security	<a href="http://www.ti.com/security">www.ti.com/security</a>
Space, Avionics and Defense	<a href="http://www.ti.com/space-avionics-defense">www.ti.com/space-avionics-defense</a>
Video and Imaging	<a href="http://www.ti.com/video">www.ti.com/video</a>

**TI E2E Community** [e2e.ti.com](http://e2e.ti.com)