

Features

- Glass Passivated Die Construction
- Low Forward Voltage Drop
- High Current Capability
- High Reliability
- High Surge Current Capability

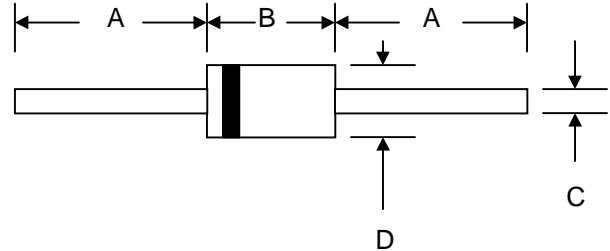

Mechanical Data

- Case: DO-15, Molded Plastic
- Terminals: Plated Leads Solderable per MIL-STD-202, Method 208
- Polarity: Cathode Band
- Weight: 0.40 grams (approx.)
- Mounting Position: Any
- Marking: Type Number
- **Lead Free: For RoHS / Lead Free Version, Add "-LF" Suffix to Part Number, See Page 4**

DO-15		
Dim	Min	Max
A	25.4	—
B	5.50	7.62
C	0.71	0.864
D	2.60	3.60
All Dimensions in mm		

Maximum Ratings and Electrical Characteristics @ $T_A=25^\circ\text{C}$ unless otherwise specified

Single Phase, half wave, 60Hz, resistive or inductive load.
For capacitive load, derate current by 20%.

Characteristic	Symbol	HER 201G	HER 202G	HER 203G	HER 204G	HER 205G	HER 206G	HER 207G	HER 208G	Unit	
Peak Repetitive Reverse Voltage	V_{RRM}	50	100	200	300	400	600	800	1000	V	
Working Peak Reverse Voltage	V_{RWM}										
DC Blocking Voltage	V_R										
RMS Reverse Voltage	$V_{R(RMS)}$	35	70	140	210	280	420	560	700	V	
Average Rectified Output Current (Note 1)	I_o	2.0								A	
Non-Repetitive Peak Forward Surge Current 8.3ms Single half sine-wave superimposed on rated load (JEDEC Method)	I_{FSM}	60								A	
Forward Voltage @ $I_F = 2.0A$	V_{FM}	1.0			1.3		1.7			V	
Peak Reverse Current @ $T_A = 25^\circ\text{C}$ At Rated DC Blocking Voltage @ $T_A = 100^\circ\text{C}$	I_{RM}	5.0				100				μA	
Reverse Recovery Time (Note 2)	t_{rr}	50					75				nS
Typical Junction Capacitance (Note 3)	C_j	60					40				pF
Operating Temperature Range	T_j	-65 to +150								$^\circ\text{C}$	
Storage Temperature Range	T_{STG}	-65 to +150								$^\circ\text{C}$	

Note: 1. Leads maintained at ambient temperature at a distance of 9.5mm from the case
 2. Measured with $I_F = 0.5A$, $I_R = 1.0A$, $IRR = 0.25A$. See figure 5.
 3. Measured at 1.0 MHz and applied reverse voltage of 4.0V D.C.

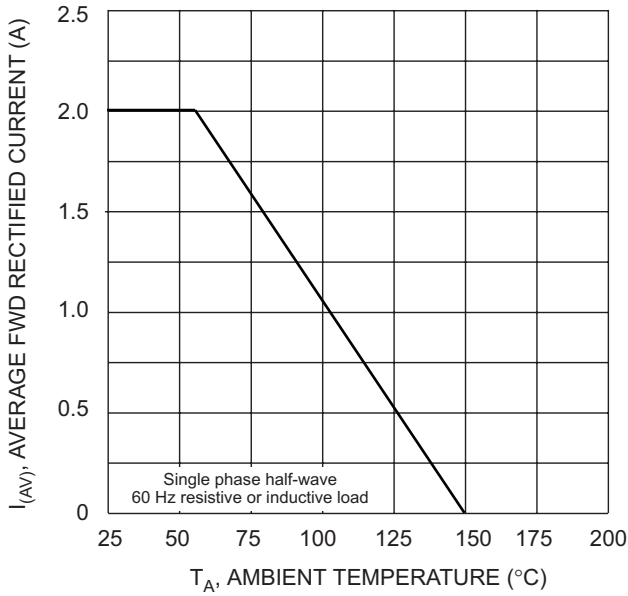

Fig. 1 Forward Current Derating Curve

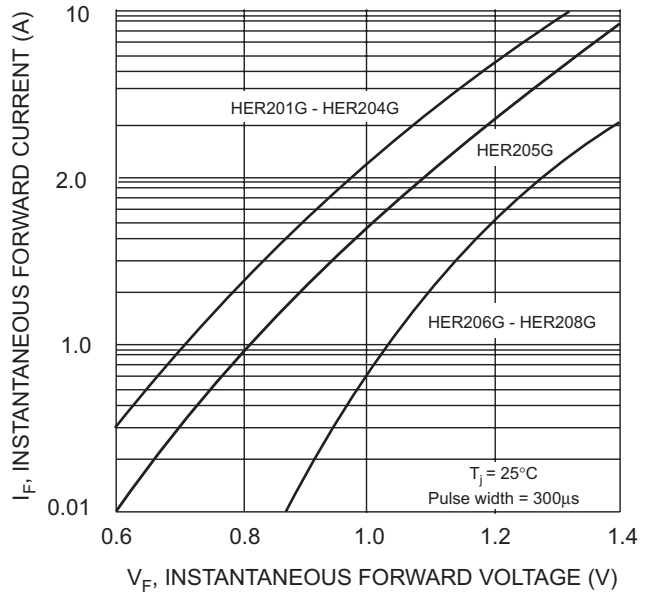

Fig. 2 Typical Forward Characteristics

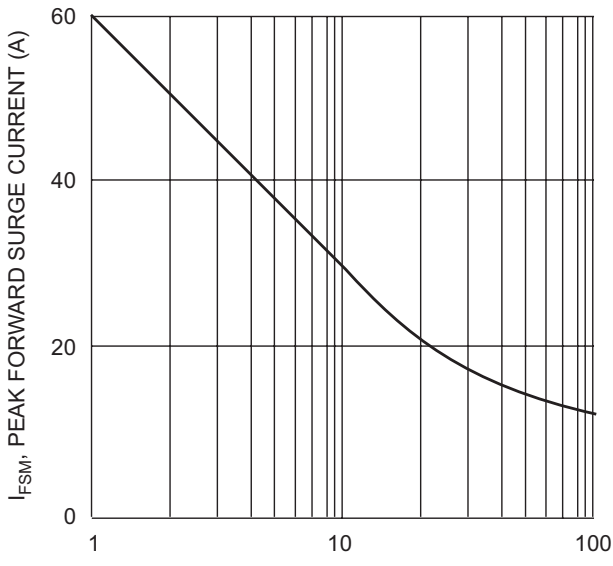

Fig. 3 Peak Forward Surge Current

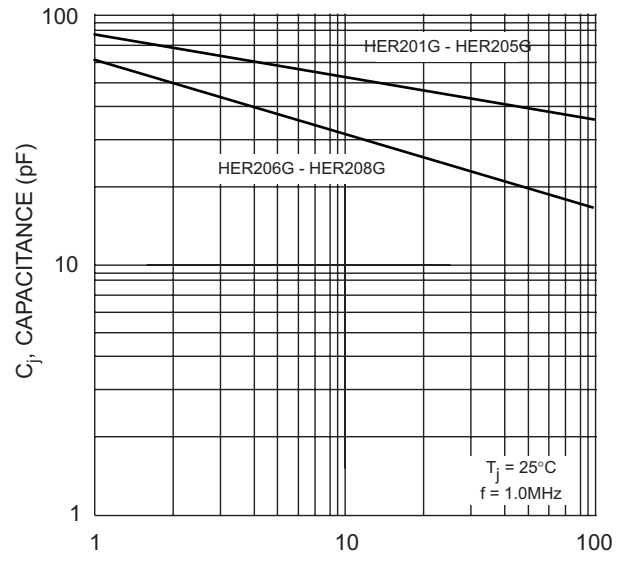
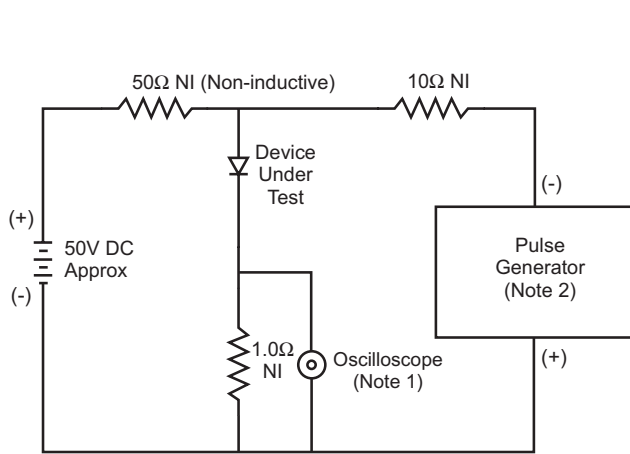

Fig. 4 Typical Junction Capacitance



- Notes:
1. Rise Time = 7.0ns max. Input Impedance = 1.0MΩ, 22pF.
 2. Rise Time = 10ns max. Input Impedance = 50Ω.

Fig. 5 Reverse Recovery Time Characteristic and Test Circuit

MARKING INFORMATION

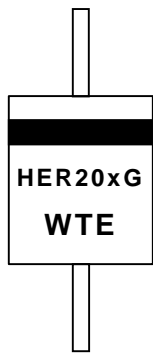

Cathode = Polarity Band
 HER20xG = Device Number
 x = 1, 2, 3, 4, 5, 6, 7 or 8
 WTE = Manufacturer's Logo

TAPING SPECIFICATIONS

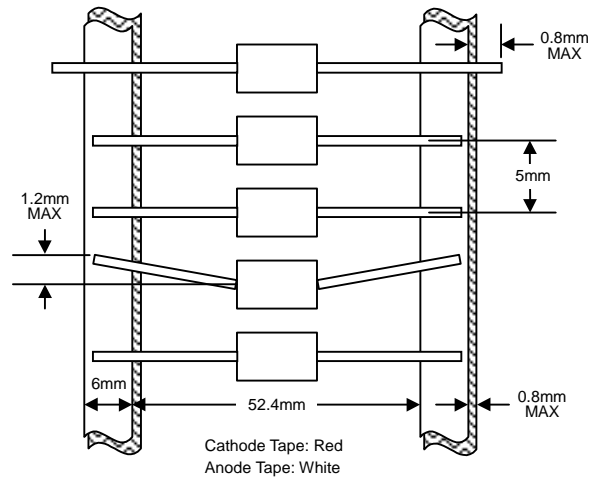

PACKAGING INFORMATION

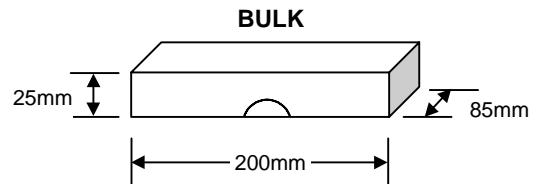
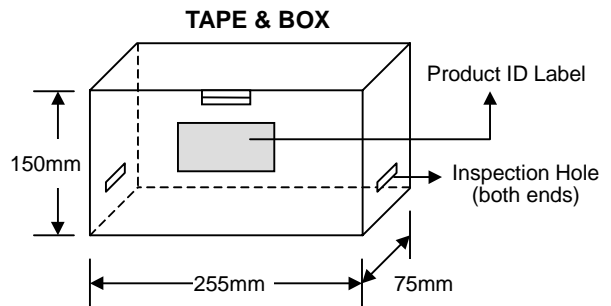
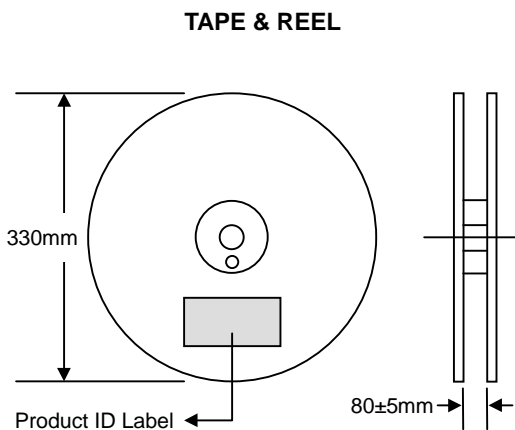

Packaging	Reel Diameter / Box Size (mm)	Quantity (PCS)	Carton Size (mm)	Quantity (PCS)	Approx. Gross Weight (KG)
TAPE & REEL	330	4,000	370 x 370 x 420	20,000	12.0
TAPE & BOX	255 x 75 x 150	3,000	400 x 273 x 415	30,000	15.0
BULK	200 x 85 x 25	1,000	459 x 214 x 256	40,000	17.5

Note: 1. Paper reel, white or gray color. Core material: plastic or metal.
 2. Components are packed in accordance with EIA standard RS-296-E.

ORDERING INFORMATION

Product No.	Package Type	Shipping Quantity
HER201G-T3	DO-15	4000/Tape & Reel
HER201G-TB	DO-15	3000/Tape & Box
HER201G	DO-15	1000 Units/Box
HER202G-T3	DO-15	4000/Tape & Reel
HER202G-TB	DO-15	3000/Tape & Box
HER202G	DO-15	1000 Units/Box
HER203G-T3	DO-15	4000/Tape & Reel
HER203G-TB	DO-15	3000/Tape & Box
HER203G	DO-15	1000 Units/Box
HER204G-T3	DO-15	4000/Tape & Reel
HER204G-TB	DO-15	3000/Tape & Box
HER204G	DO-15	1000 Units/Box
HER205G-T3	DO-15	4000/Tape & Reel
HER205G-TB	DO-15	3000/Tape & Box
HER205G	DO-15	1000 Units/Box
HER206G-T3	DO-15	4000/Tape & Reel
HER206G-TB	DO-15	3000/Tape & Box
HER206G	DO-15	1000 Units/Box
HER207G-T3	DO-15	4000/Tape & Reel
HER207G-TB	DO-15	3000/Tape & Box
HER207G	DO-15	1000 Units/Box
HER208G-T3	DO-15	4000/Tape & Reel
HER208G-TB	DO-15	3000/Tape & Box
HER208G	DO-15	1000 Units/Box

1. Products listed in **bold** are WTE **Preferred** devices.
2. Shipping quantity given is for minimum packing quantity only. For minimum order quantity, please consult the Sales Department.
3. **To order RoHS / Lead Free version (with Lead Free finish), add "-LF" suffix to part number above. For example, HER201G-TB-LF.**

Won-Top Electronics Co., Ltd (WTE) has checked all information carefully and believes it to be correct and accurate. However, WTE cannot assume any responsibility for inaccuracies. Furthermore, this information does not give the purchaser of semiconductor devices any license under patent rights to manufacturer. WTE reserves the right to change any or all information herein without further notice.

WARNING: DO NOT USE IN LIFE SUPPORT EQUIPMENT. WTE power semiconductor products are not authorized for use as critical components in life support devices or systems without the express written approval.

Won-Top Electronics Co., Ltd.

No. 44 Yu Kang North 3rd Road, Chine Chen Dist., Kaohsiung, Taiwan

Phone: 886-7-822-5408 or 886-7-822-5410

Fax: 886-7-822-5417

Email: sales@wontop.com

Internet: http://www.wontop.com

We power your everyday.