

POWER SWITCHING TRANSISTORS

Screened to equivalent per JANTX or JANTXV levels on request

T.35-19

Case Style (shown actual size)

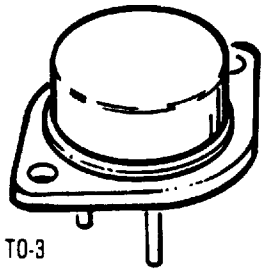

TO-3

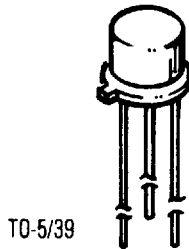

TO-5/39

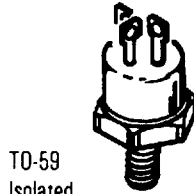

TO-59
Isolated

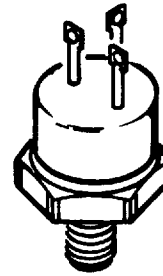

TO-61
Isolated

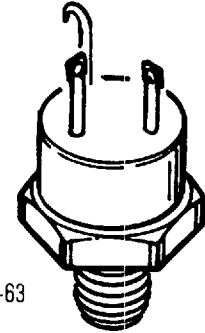

TO-63

Discrete Power Switching Transistors

Part No.	Case Style	I _c (Oper) (Amps)	I _c (Max.) (Cont) (Amps)	V _{CEO} (Min., Sus) (Volts)	V _{CEO} (Min.) (Volts)	V _{EB0} (Min.) (Volts)	h _{FE} @ Rated I _c (Amps)	V _{CE(SAT)} (Max.) (Volts)	T _{off} (Max.) (μsec)
SVT100-5	TO-5/39	5.0	5.0	100	100	6.0	40 @ 1 A	1.0	0.4
SVT200-5C	TO-3	5.0	10	200	225	7.0	15 @ 5 A	1.0	3.0
SVT250-3C	TO-3	3.0	5.0	250	275	6.0	15 @ 3 A	1.0	2.0
SVT250-5C	TO-3	5.0	10.0	250	275	6.0	15 @ 5 A	1.0	2.0
SVT300-3C	TO-3	3.0	5.0	300	325	6.0	15 @ 3 A	1.0	2.0
SVT300-5C	TO-3	5.0	10	300	325	6.0	15 @ 5 A	1.0	2.0
SVT350-3C	TO-3	3.0	5.0	350	350	7.0	15 @ 3 A	1.2	3.0
SVT350-5C	TO-3	5.0	10	350	350	7.0	15 @ 5 A	1.2	3.0
SVT400-3C	TO-3	3.0	5.0	400	400	7.0	15 @ 3 A	1.2	3.0
SVT400-5C	TO-3	5.0	10	400	400	7.0	15 @ 5 A	1.2	3.0
SVT450-3C	TO-3	3.0	5.0	450	450	7.0	15 @ 3 A	1.2	3.0
SVT450-5C	TO-3	5.0	10	450	450	7.0	15 @ 5 A	1.2	3.0
SVT60-5	TO 5/39	5.0	5.0	60	60	6.0	40 @ 1 A	1.0	0.4
SVT80-5	TO 5/39	5.0	5.0	80	80	6.0	40 @ 1 A	1.0	0.4
2N4305	TO-5/39	5.0	5.0	80	120	6.0	50-150 @ 1 A	1.0	0.4
2N4307	TO-5/39	5.0	5.0	60	100	6.0	50-150 @ 1 A	1.0	0.4
2N4309	TO-5/39	5.0	5.0	80	120	6.0	40-120 @ 1 A	1.0	0.4
2N4311	TO-5/39	5.0	5.0	60	100	6.0	40-120 @ 1 A	1.0	0.4
2N5154	TO-5/39	5.0	10	80	100	6.0	70-200 @ 2.5 A	0.75	1.0
2N5326	TO-59	5.0	5.0	80	120	6.0	50-150 @ 1 A	1.0	0.4
2N5328	TO-59	10	10	70	100	5.0	100-300 @ 1 A	0.6	0.9
2N5329	TO 61	20	30	90	150	8.0	40-120 @ 10 A	1.8	1.1
2N5330	TO-61	30	30	90	150	8.0	10 @ 30 A	0.6	1.25
2N5331	TO-63	30	30	90	150	8.0	10 @ 30 A	0.6	0.25
2N6579	TO-3	5.0	10	350	450	9.0	7-35 @ 5 A	1.5	2.5
2N6580	TO-3	5.0	10	400	500	9.0	7-35 @ 5 A	1.5	2.5
2N6581	TO-3	5.0	10	450	550	9.0	7-35 @ 5 A	1.5	2.5
2N6582	TO-3	7.0	10	350	450	9.0	7-35 @ 7 A	1.5	2.5
2N6583	TO-3	7.0	10	400	500	9.0	7-35 @ 7 A	1.5	2.5
2N6584	TO-3	7.0	10	450	550	9.0	7-35 @ 7 A	1.5	2.5
2N6585	TO-61	5.0	10	350	450	9.0	7-35 @ 5 A	1.5	2.5
2N6586	TO 61	5.0	10	400	500	9.0	7-35 @ 5 A	1.5	2.5
2N6587	TO-61	5.0	10	450	550	9.0	7-35 @ 5 A	1.5	2.5
2N6588	TO-61	7.0	10	350	450	9.0	7-35 @ 7 A	1.5	2.5
2N6589	TO-61	7.0	10	400	500	9.0	7-35 @ 7 A	1.5	2.5
2N6590	TO-61	7.0	10	450	550	9.0	7-35 @ 7 A	1.5	2.5

Monolithic Darlington Power Switching Transistors

Part No.	Case Style	I _c (Cont) (Amps)	I _c (PK) (Amps)	V _{CEO} (Min., Sus) (Volts)	V _{CEO} (Min.) (Volts)	h _{FE} (Min.) @ I _c = 10 A	V _{CE(SAT)} (Max.) (Volts)	V _{BE(SAT)} (Max.) (Volts)	T _{off} (Max.) (μsec)
SVT6000H	TO-3	15	20	300	400	60	1.6	2.5	1.2
SVT6001H	TO-3	15	20	350	450	60	1.6	2.5	1.2
SVT6002H	TO-3	15	20	400	500	60	1.6	2.5	1.2
SVT6060H	TO-3	20	25	300	400	100	1.5	2.5	1.2
SVT6061H	TO-3	20	25	350	450	100	1.5	2.5	1.2
SVT6062H	TO-3	20	25	400	500	100	1.5	2.5	1.2
SVT6251H	TO-3	10	15	350	400	40	2.5	2.5	1.5
SVT6252H	TO-3	10	15	400	450	40	2.5	2.5	1.5
SVT6253H	TO 3	10	15	450	500	40	2.5	2.5	1.5

Ultra-Fast Power Diodes

These devices are designed for use in power control and conversion circuits where high efficiency and reliability, coupled with small size and weight are requirements. The ultra-fast switching

speed provides important reliability and performance advantages in switching regulators, converters, inverters that operate at 15 to 20kHz and above.

Electrical Characteristics (T_{case} = 25°C)

Type	PIV Vdc	I _F Adc	V _F @ I _F Vdc	I _R @ PIV μ A	I _{SURGE} * A	T _{RR} MAX (1A to 1A to 1/2A) nsec	θ_{jc} °C/W	Package
SVD50-6	50	6	1.2	10	60	50	2.5	DO-4 DO 4 Isolated
SVD50-12	50	12	1.2	10	120	50	2.5	DO 4, DO-4 Isolated
SVD50-30	50	30	1.2	10	200	70	1.5	DO-5, DO 5 Isolated
SVD100-6	100	6	1.2	10	60	50	2.5	DO-4, DO-4 Isolated
SVD100-12	100	12	1.2	10	120	50	2.5	DO-4, DO-4 Isolated
SVD100-30	100	30	1.2	10	200	70	1.5	DO-5, DO 5 Isolated
1N5410	150	12	1.0	10	200	70	2.0	DO 4
1N5409	150	30	1.2	10	200	70	1.5	DO 5
SVD300-12	300	12	1.5	10	120	70	2.5	DO-4 DO-4 Isolated
SVD350-12	350	12	1.5	10	120	70	2.5	DO 4, DO 4 Isolated
SVD400-12	400	12	1.5	10	120	70	2.5	DO 4 DO 4 Isolated
SVD450-12	450	12	1.5	10	120	70	2.5	DO-4, DO-4 Isolated

Storage Temperature: -65°C to +175°C

Operating Temperature: -65°C to +175°C

*1msec operating surge, T_{case} = 100°C, duty cycle <1%

DO-4 Isolated

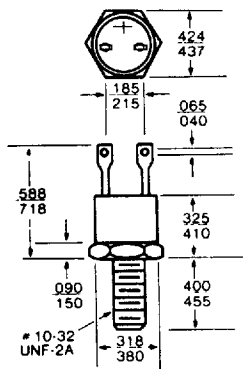

DO-4

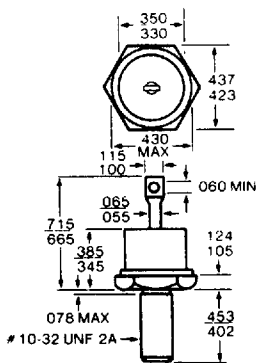

DO-5 Isolated

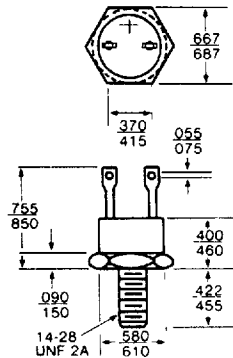

DO-5

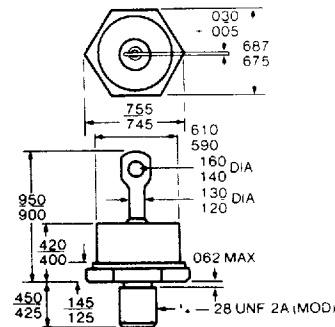

Typical Circuit Applications

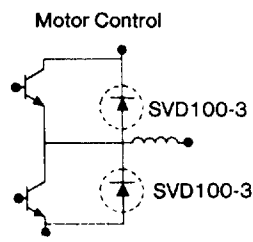
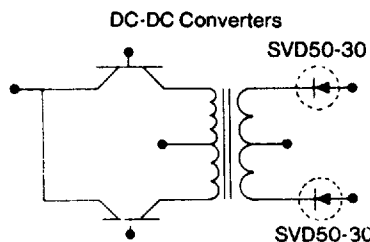
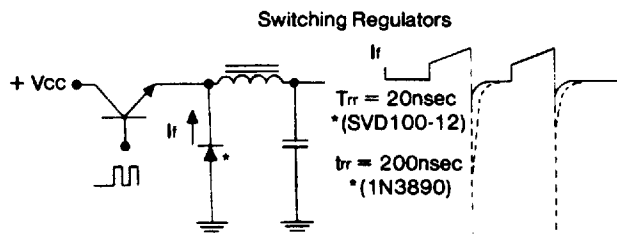

Optek reserves the right to make changes at any time in order to improve design and to supply the best product possible.

Optek Technology, Inc., 1215 West Crosby Road, Carrollton, Texas 75006 (214) 323-2200 TLX 215849 Fax (214) 323-2396

Printed in USA