

Thyristors and AC switches

from SCRs and TRIACS to innovative devices



USE IN LIFE SUPPORT DEVICES OR SYSTEMS MUST BE EXPRESSLY AUTHORIZED.

STMicroelectronics PRODUCTS ARE NOT AUTHORIZED FOR USE AS CRITICAL COMPONENTS IN LIFE SUPPORT DEVICES OR SYSTEMS WITHOUT THE EXPRESS WRITTEN APPROVAL OF STMicroelectronics. As used herein:

1. Life support devices or systems are those which (a) are intended for surgical implant into the body, or (b) support or sustain life, and whose failure to perform, when properly used in accordance with instructions for use provided with the product, can be reasonably expected to result in significant injury to the user.

2. A critical component is any component of a life support device or system whose failure to perform can reasonably be expected to cause the failure of the life support device or system, or to affect its safety or effectiveness.

DESIGNER'S SELECTION GUIDE

Index

PRODUCT REFERENCES	Page 2
SCRs:	
<i>Functionality and Main Applications</i>	Page 5
<i>Packages</i>	Page 6
<i>Sensitive gate SCRs</i>	Page 7
<i>Standard SCRs</i>	Page 8
<i>SCR Modules</i>	Page 9
TRIACs :	
<i>Functionality and Main Applications</i>	Page 10
<i>Packages</i>	Page 12
<i>Standard TRIACs</i>	Page 13
<i>Snubberless™ & Logic Level TRIACs</i>	Page 15
<i>High temperature TRIACs</i>	Page 18
DIACs	Page 19
IGNITORS:	
<i>FLC for Industrial Applications</i>	Page 20
<i>LIC for Lighting Applications</i>	Page 21
AC SWITCHES:	
<i>ACS™ and ACST Devices for Home Appliances</i>	Page 23
<i>Packages</i>	Page 25
<i>ACS™ and ACST Devices for Home Appliances</i>	Page 26
ASDs for INDUSTRIAL APPLICATIONS:	
<i>Inrush Current Limitation Circuit</i>	Page 27
<i>Current Limited Overvoltage Protected Quad Digital Termination</i>	Page 28
KEY APPLICATIONS & RECOMMENDED PRODUCTS	Page 29
CROSS-REFERENCE	Page 36
APPLICATION NOTES	Page 48

PRODUCT REFERENCES

Index

The intention of this selector guide is to provide the latest information about STMicroelectronics Thyristors families. For fast and easy selection, each product family has been organized by current and voltage.

SCRs

TSxxyy-zzz

xx	Forward current	4 = 4 Amps
yy	Sensitivity	20 = 0.2 mA
zzz	Blocking voltage	600 = 600 Volts
Package	TSxxxB TSxxxH TSxxxT	DPAK IPAK TO-220AB

TNxxyy-zzz

xx	Forward current	8 = 8 Amps 12 = 12 Amps
yy	Sensitivity	05 = 5 mA 25 = 25 mA
zzz	Blocking voltage	600 = 600 Volts
Package	TNxxxB TNxxxG TNxxxH	DPAK D ² PAK IPAK

XLxxyy

L	Application	Light control
xx	Current	08 = 0.8A
yy	Voltage	40 = 400V

TYNxxyy

xx	Blocking voltage	6 = 600 Volts 10 = 1000 Volts
yyy	Forward current	10 = 10 Amps
Package		TO-220AB

BTWxx-yyy

xx	Forward current codification	
yy	Blocking voltage	600 = 600 Volts
Package	BTW67 BTW68/69	RD91 (insulated) TOP3 insulated

P01xxx / X0xxx

P	P01xxx / X0xxx					PACKING SUFFIX			
	01	02	M	A	BLANK	Tube	Bulk	Ammopack	Tape & Reel
Function	Current	Sensitivity	Voltage	Package					
P: SCR	006: 0.8A	02 = 200µA	B : 200 Volts	A : TO-92			1AA3 or 1BA2	2AL3 or 2BA2	5AL3 or 5BL2
X: SCR	01: 0.8A	05 = 50µA	D : 400 Volts	F : TO202-3		0AA2	1AA2		
	02: 1.25A	11 = 25µA	M : 600 Volts	L : SOT-23					5AA4
	04: 4A	18 = 5µA	S : 700 Volts	N : SOT-223					5AA4 or 5BA4
			N : 800 Volts						

DIACs

DBx/SMDBx

xx	Breakover voltage	3 = 32 Volts 4 = 40 Volts
Package	DBx SMDBx	DO-35 SOT-23

PRODUCT REFERENCES

Index

TRIACs

Txxyy-zzz / TxxyyH-zzz / TxxyyQ-zzz

xx	Forward Current	8 = 8 Amps
yy	Sensitivity	20 = 20 mA
H	High junction temperature	
Q	Four quadrants	
zzz	Blocking Voltage	600 = 600 Volts
Package	B G H T W	DPAK D ² PAK IPAK TO-220AB ISOWATT220AB

Txxyy-zzzW

xx	Forward Current	8 = 8 Amps
yy	Sensitivity	20 = 20 mA
zzz	Blocking Voltage	600 = 600 Volts
W	Package	ISOWATT220AB

BTA/BTBxx-yyy

xx	Forward current	8 = 8 Amps
yyy	Blocking voltage	600 = 600 Volts
Package	BTA: insulated BTB: Non insulated	TO-220AB RD91(Insulated) TOP3 Insulated

BTA/BTBxx-yyy

BTA/Bxx-yyy	B	Standard	Igt = 50 mA
	BW	Snubberless™	Igt = 50 mA
	C	Sensitive	Igt = 25 mA
	CW	Snubberless™	Igt = 35 mA
	SW	Logic Level	Igt = 10 mA
	TW	Logic Level	Igt = 5 mA

BTBxx-yyzL

xx	Forward current	04 = 4 Amps
yy	Blocking voltage	600 = 600 Volts
z	Sensitivity	S = 10mA
L	Application	Lighting

Z0xxx

Z	01	03	M	A	BLANK	PACKING SUFFIX			
Function	Current	Sensitivity	Voltage	Package		Tube	Bulk	Ammopack	Tape & Reel
Z: Triacs	006: Up to 0.8A	03: 3/5 mA	D: 400 Volts	A: TO-92			1AA2 or 1BA2	2AL2 or 2BL2	5AL2 or 5BL2
	01: Up to 1A	07: 5/7 mA	M: 600 Volts	F: TO202-3		0AA2	1AA2		
	04: 4A	09: 10 mA	S: 700 Volts	N: SOT-223					5AA4

PRODUCT REFERENCES

Index

IGNITORS

FLC	0	1	-	200	H
Function	Power	Gate		Voltage	Package
Fire Lighter Circuit	0: 190A / 10 ms 1: 240A / 10 ms 2: 90A / 10 ms	0 or 1: No external gate		Stand off-voltage	A: TO-92 B: DPAK H: IPAK

LIC	01	-	215	B
Function	Power		Voltage	Package
Light Ignitor Circuit	01: 50A / 10 ms		Break-over voltage	H: IPAK B: DPAK

TN22	-	1500	H
Function		Voltage	Package
Electronic Starter		1500: 1500 Volts	H: IPAK

AC SWITCHES

ACS™	4	02	-	5S	B4
Function	Number of Switch	I _T (RMS) by Switch		Voltage-Sensitivity	Package
AC Switch	1: 1 3: 3 4: 4	02: 0.2A 08: 0.8A 10: 1A 20: 2A		5: 500 Volts S: Sensitivity 10mA T: Sensitivity 5mA	A: TO-92 N: SOT-223 B4: DIP-20 T1: SO-8

ACST	6	-	7S	T
Function	Number of Switch		Voltage-Sensitivity	Package
AC Switch	4: 4A 6: 6A 8: 8A		7: 700 Volts S: Sensitivity 10mA C: Sensitivity 35mA	T: TO-220AB FP: TO-220FPAB

INRUSH CURRENT LIMITERS

STIL	04	-	P5
Function	Output Current		Package
Inrush Current Limiter	02: 2A 04: 4A		Pentawatt HV2

CURRENT LIMITED TERMINATION

CLT	3	-	4	B	T6
Function	Limited Current Value		Number of Channels	EMC Level	Package
Current Limited Termination	3: 3mA		4:4 Channels	B: 1000 V	T6:TSSOP20

SCRs

Functionality & Main Applications

Based on an unidirectional structure, SCRs (or Silicon Controlled Rectifiers) are used as switching devices in pulse mode or half-wave bridge circuits - Available in standard or sensitive gate drive configurations with a large range of through-hole and surface mount packages, they fit a large number of applications.

Typical I/V Characteristic of a SCR

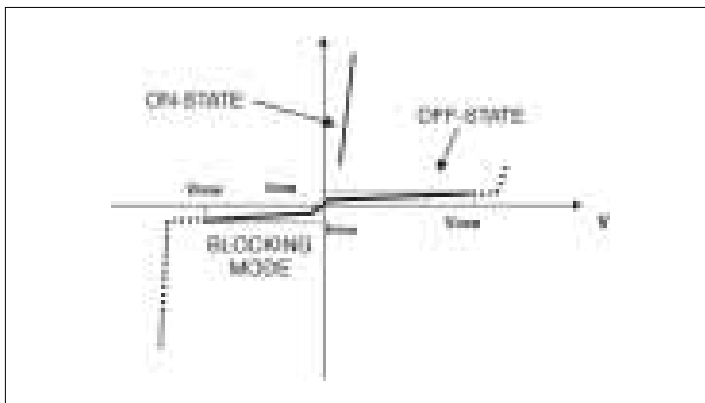

SCR Symbol

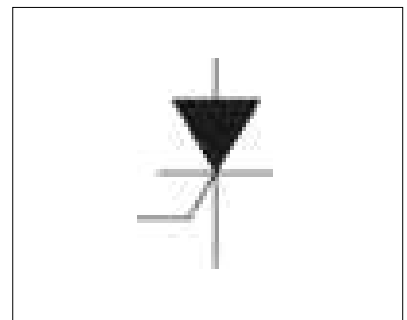

DIFFERENT MODES OF CONTROL

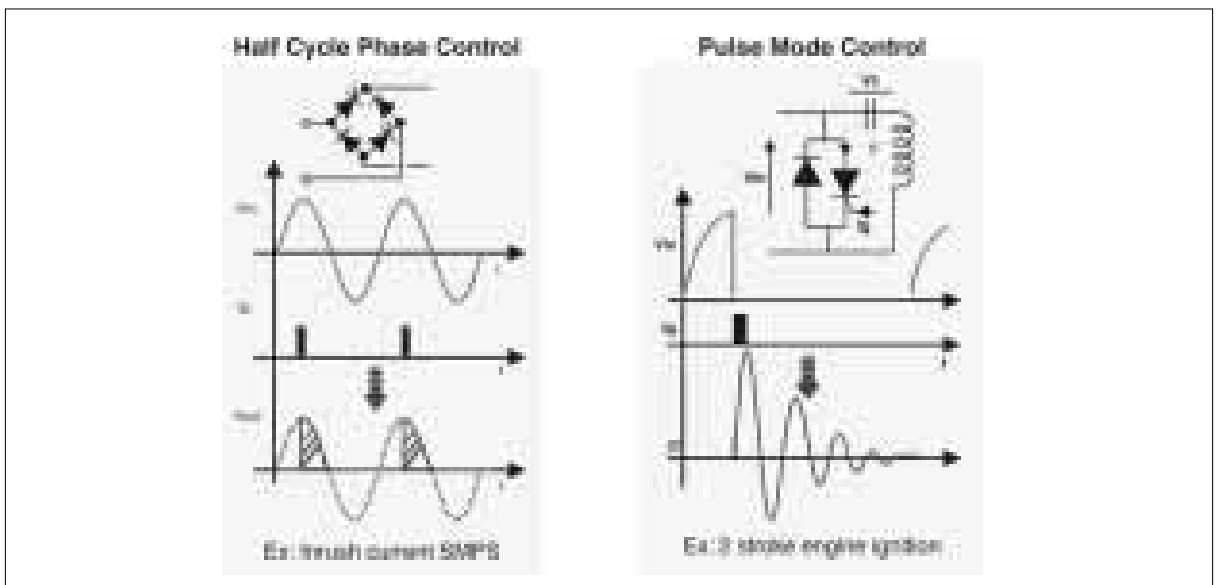

MAIN APPLICATIONS

- Static relays
- Power supplies
- Electrical power tools
- Ground Fault interruptors
- Smoke and Alarm detectors
- Two stroke engine ignition
- Small Kitchen aids, blenders, mixers...
- Housecare appliances irons, electric razors,...
- Battery voltage regulation
- Industrial motor control
- Welding equipment
- Electronic neon starter

SCRs

Packages

SMD PACKAGES



SOT-23



SOT-223



IPAK



DPAK

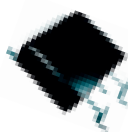

D²PAK

INSERTION PACKAGES



TO-92



TO202-3



TO-220AB

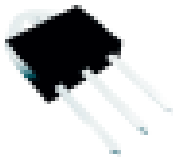

TOP3



RD 91



ISOTOP

SCRs

Sensitive Gate SCRs

Sensitive SCRs are easy to drive thanks to their very low gate current triggering. They are suitable for low power applications where low consumption is mandatory, such as ground fault interruptors, engine ignition, pilot circuit in solid state relays, smoke and alarm detectors...

$I_{T(RMS)}$	V_{RRM} V_{DRM}	Part Number	$I_{TSM}^{* (1)}$	I_{GT}^{*}	I_H^{*}	$V_{TM}^{*} @ I_{TM}$		dV/dt min. @ T_j max	Package
	(V)		(A)	max (μ A)	max (mA)	(V)	(A)	(V/ μ s)	
0.25 Amps	200	P0102BL	6	200	5	1.7	0.4	200	SOT-23
		P0102DA	7	200	5	1.95	1.6	75	TO-92
0.8 Amps	400	P0102DN	7	200	5	1.95	1.6	75	SOT-223
		P0111DA	7	25	5	1.95	1.6	80	TO-92
		P0111DN	7	25	5	1.95	1.6	80	SOT-223
		P0118DA	7	5	5	1.95	1.6	75	TO-92
		P0118DN	7	5	5	1.95	1.6	75	SOT-223
		XL0840 (2)	7	200	5	1.95	1.6	75	TO-92
	600	P0102MA	7	200	5	1.95	1.6	75	TO-92
		P0102MN	7	200	5	1.95	1.6	75	SOT-223
		P0111MA	7	25	5	1.95	1.6	80	TO-92
		P0111MN	7	25	5	1.95	1.6	80	SOT-223
		P0118MA	7	5	5	1.95	1.6	75	TO-92
		P0118MN	7	5	5	1.95	1.6	75	SOT-223
		X00602MA	9	200	5	1.35	1	25	TO-92
		1.25 Amps	800	X0202MA	22.5	200	5	1.45	2.5
X0202MN	22.5			200	5	1.45	2.5	15	SOT-223
X0205MA	22.5			50	5	1.45	2.5	15	TO-92
X0205MN	22.5			50	5	1.45	2.5	15	SOT-223
800	X0202NA		22.5	200	5	1.45	2.5	10	TO-92
	X0202NN		22.5	200	5	1.45	2.5	10	SOT-223
	X0205NA		22.5	50	5	1.45	2.5	15	TO-92
	X0205NN		22.5	50	5	1.45	2.5	15	SOT-223
4 Amps	600	TS420-600B	30	200	5	1.6	8	5	DPAK
		TS420-600H	30	200	5	1.6	8	5	IPAK
		TS420-600T	30	200	5	1.6	8	5	TO-220AB
		X0402MF	30	200	5	1.8	8	10	TO202-3
		X0405MF	30	50	5	1.8	8	15	TO202-3
	700	TS420-700B	30	200	5	1.6	8	5	DPAK
		TS420-700H	30	200	5	1.6	8	5	IPAK
		TS420-700T	30	200	5	1.6	8	5	TO-220AB
	800	X0402NF	30	200	5	1.8	8	10	TO202-3
		X0405NF	30	50	5	1.8	8	15	TO202-3
8 Amps	600	TS820-600B	70	200	5	1.6	16	5	DPAK
		TS820-600H	70	200	5	1.6	16	5	IPAK
		TS820-600T	70	200	5	1.6	16	5	TO-220AB
	700	TS820-700B	70	200	5	1.6	16	5	DPAK
		TS820-700H	70	200	5	1.6	16	5	IPAK
		TS820-700T	70	200	5	1.6	16	5	TO-220AB
12 Amps	600	TS1220-600B	110	200	5	1.6	24	5	DPAK
		TS1220-600H	110	200	5	1.6	24	5	IPAK
	700	TS1220-700B	110	200	5	1.6	24	5	DPAK
		TS1220-700H	110	200	5	1.6	24	5	IPAK

(*) I_{TSM} , I_{GT} , I_H and V_{TM} specified at $T_j = 25^\circ\text{C}$

(1) $t_p = 10$ ms

(2) Unidirectional voltage only

Note 1: B suffix = 200V, D suffix = 400V, M suffix = 600V, N suffix = 800V

Note 2: 2500V_{RMS} insulation voltage - UL recognized file # E81734

NEW PRODUCT

SCRs

Standard SCRs (T_j max = 125°C)

The standard SCRs are ideal for general purpose switching applications like battery voltage regulation, crowbar protection in power supplies, motor control, welding equipment...

I _{T(RMS)} (A)	V _{RRM} V _{DRM} (V)	Part Number	I _{TSM} * (1) (A)	I _{GT} * max (mA)	I _H * max (mA)	V _{TM} * @ I _{TM} (V)	I _{TM} (A)	dV/dt min. @ T _j max (V/μs)	Package
8 Amps	600	TN805-600B	70	5	25	1.6	16	50	DPAK
		TN805-600H	70	5	25	1.6	16	50	IPAK
		TN815-600B	70	15	40	1.6	16	150	DPAK
		TN815-600H	70	15	40	1.6	16	150	IPAK
		TYN608	95	15	30	1.6	16	150	TO-220AB
	800	TN805-800B	70	5	20	1.6	16	50	DPAK
		TN805-800H	70	5	20	1.6	16	50	IPAK
		TN815-800B	70	15	40	1.6	16	150	DPAK
		TN815-800H	70	15	40	1.6	16	150	IPAK
		TYN808	95	15	30	1.6	16	150	TO-220AB
1000	TYN1008	95	15	30	1.6	16	150	TO-220AB	
12 Amps	600	TN1215-600B	110	15	40	1.6	24	200	DPAK
		TN1215-600G	140	15	30	1.6	24	200	D ² PAK
		TN1215-600H	110	15	40	1.6	24	200	IPAK
		TYN612	140	15	30	1.6	24	200	TO-220AB
		TYN612T	140	5	15	1.6	24	40	TO-220AB
	800	TN1215-800B	110	15	40	1.6	24	200	DPAK
		TN1215-800G	140	15	30	1.6	24	200	D ² PAK
		TN1215-800H	110	15	40	1.6	24	200	IPAK
		TYN812	140	15	30	1.6	24	200	TO-220AB
		TYN812T	140	5	15	1.6	24	40	TO-220AB
	1000	TN1215-1000G	140	15	30	1.6	24	200	D ² PAK
		TYN1012	140	15	30	1.6	24	200	TO-220AB
		TYN1012T	140	5	15	1.6	24	40	TO-220AB
16 Amps	600	TN1625-600G	190	25	40	1.6	32	500	D ² PAK
		TYN616	190	25	40	1.6	32	500	TO-220AB
	800	TN1625-800G	190	25	40	1.6	32	500	D ² PAK
		TYN816	190	25	40	1.6	32	500	TO-220AB
	1000	TN1625-1000G	190	25	40	1.6	32	500	D ² PAK
		TYN1016	190	25	40	1.6	32	500	TO-220AB
25 Amps	600	TN2540-600G	300	40	50	1.6	50	500	D ² PAK
		TYN625	300	40	50	1.6	50	500	TO-220AB
	800	TN2540-800G	300	40	50	1.6	50	500	D ² PAK
		TYN825	300	40	50	1.6	50	500	TO-220AB
	1000	TN2540-1000G	300	40	50	1.6	50	5	D ² PAK
		TYN1025	300	40	50	1.6	50	5	TO-220AB
40 Amps	600	TN4035-600G	460	35	75	1.6	80	1000	D ² PAK
		TYN640	460	35	75	1.6	80	1000	TO-220AB
	800	TN4035-800G	460	35	75	1.6	80	1000	D ² PAK
		TYN840	460	35	75	1.6	80	1000	TO-220AB
	1000	TYN1040	460	35	75	1.6	80	1000	TO-220AB
50 Amps	600	BTW67-600	580	80	150	1.9	100	500	RD91
		BTW69-600	580	80	150	1.9	100	500	TOP3
	800	BTW67-800	580	80	150	1.9	100	500	RD91
		BTW69-800	580	80	150	1.9	100	500	TOP3
	1200	BTW67-1200	580	80	150	1.9	100	500	RD91
		BTW67-1200	580	80	150	1.9	100	500	TOP3

(*) I_{TSM}, I_{GT}, I_H and V_{TM} specified at T_j = 25°C

(1) t_p = 10 ms

Note 1: 2500 V_{RMS} insulation voltage - UL recognized file # E81734

NEW PRODUCT

SCRs

SCR Modules

SCR Modules in ISOTOP® packages have been developed for high power applications. Thanks to its optimized thermal dissipation capability and compactness, the ISOTOP package offers a high power / volume ratio. Available in SCR+diode or back-to-back SCR configuration, they can be used respectively in full bridge schemes or as an ON/OFF switch. These modules can be found in applications like welding equipment, the input controlled bridge in power supplies, thermal controls and general purpose industrial equipment.

MSSxxx back-to-back configuration

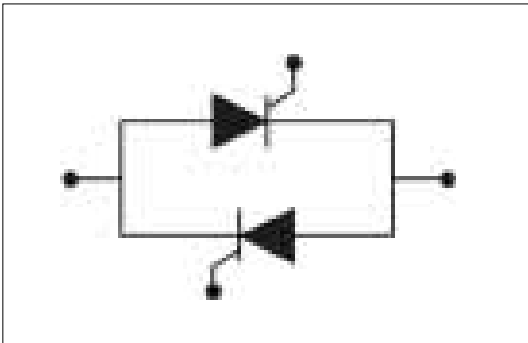

MDSxxx SCR + diode configuration

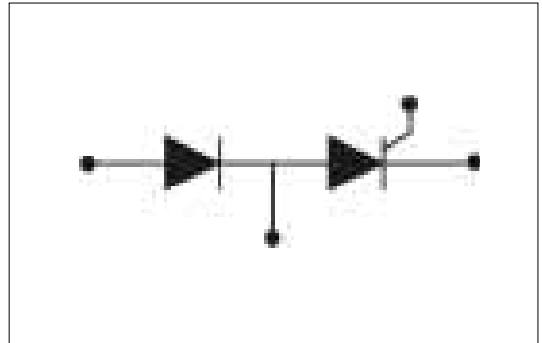

$I_{T(RMS)}$	V_{RRM} V_{DRM}	Part Number	$I_{TSM}^{* (1)}$	I_{GT} max *	I_H max *	$V_{TM}^{* @}$	I_{TM}	dV/dt min. @ T_j max	Package
	(V)		(A)	(mA)	(mA)	(V)	(A)	(V/ μ s)	
50 Amps	800	MDS35-800	400	50	80	1.7	80	1000	ISOTOP
	1200	MDS35-1200	400	50	80	1.7	80	1000	ISOTOP
55 Amps	800	MSS40-800	400 (2)	50	80	1.7	80	1000	ISOTOP
	1200	MSS40-1200	400 (2)	50	80	1.7	80	1000	ISOTOP
70 Amps	800	MDS50-800	600	50	80	1.75	110	1000	ISOTOP
		MSS50-800	600 (2)	50	80	1.7	100	1000	ISOTOP
	1200	MDS50-1200	600	50	80	1.75	110	1000	ISOTOP
		MSS50-1200	600 (2)	50	80	1.7	100	1000	ISOTOP
85 Amps	800	MDS80-800	700	100	80	1.75	170	1000	ISOTOP
	1200	MDS80-1200	700	100	80	1.75	170	1000	ISOTOP

(*) I_{TSM} , I_{GT} , I_H and V_{TM} specified at $T_j = 25^\circ C$

(1) $t_p = 10$ ms unless otherwise specified

(2) $t_p = 20$ ms

Note 1: $2500V_{RMS}$ insulation voltage - UL Recognized file # E81734

MSS: two SCRs in back to back configuration

MDS: one SCR and one diode configuration

TRIACS

Functionality & Main Applications

Thanks to their bidirectional structure, Triacs are useful in controlling full-wave AC applications. They can be used as an ON/OFF switch, replacing efficiently electro-mechanical relays (providing high degree of flexibility through electronic control, and superior reliability). They are also capable to control power level through AC loads, thanks to a simple phase control circuit. Available in general purpose standard configurations, high commutation performance series with ST Snubberless™ Technology, or high temperature versions for use in harsh environment, they fit any AC applications requiring precise control.

Typical I/V Characteristic of a Triac

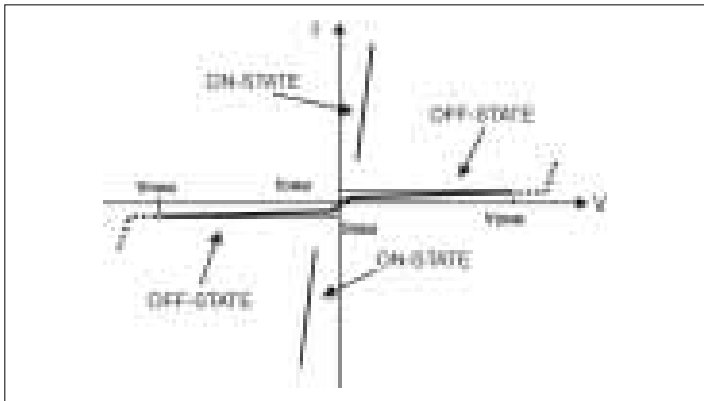

Triac Symbol

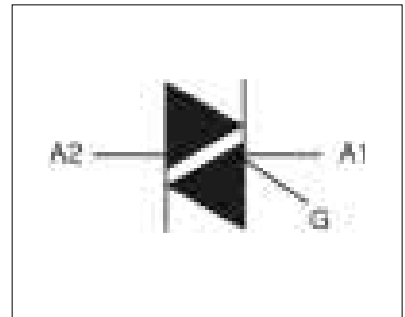

The four possible quadrants of a Triac

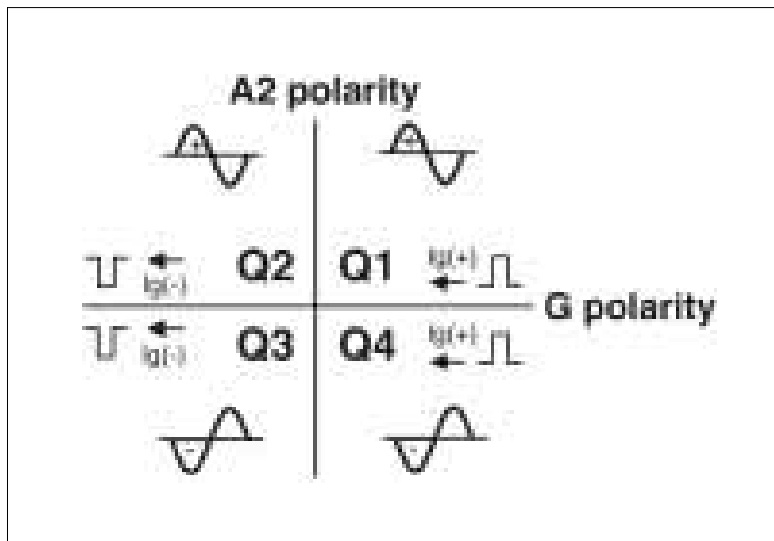

TRIACs

Functionality & Main Applications

DIFFERENT MODES OF OPERATION

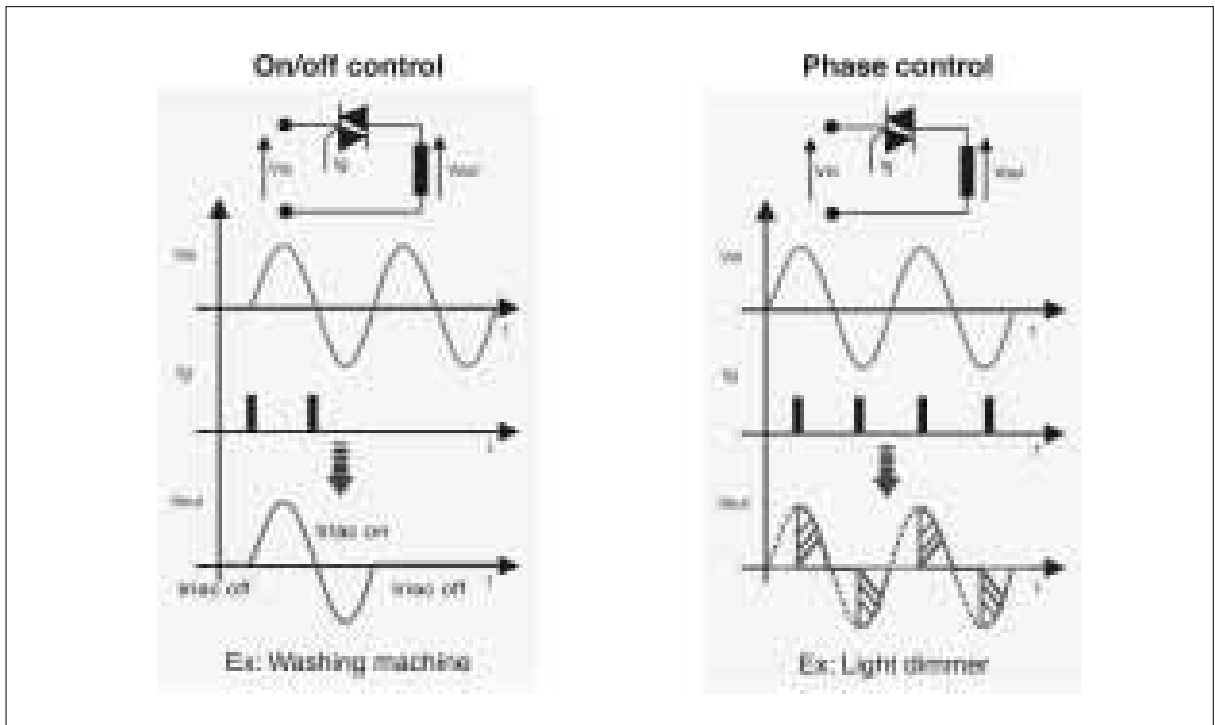

MAIN APPLICATIONS

- Home appliances
- Washing machines, dryers,
- Dishwashers, fridges, ovens...
- Food processors
- Coffee machines
- Solid State relays
- Electric tools
- Programmable controllers
- Air conditioning system
- Water heaters
- Irrigation systems
- Fan speed controllers
- Vending machines
- Light dimmers
- Electronic Ballasts

TRIACs

Packages

SMD PACKAGES



SOT-223



IPAK



DPAK

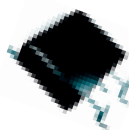

D²PAK

INSERTION PACKAGES



TO-92



TO202-3



TO-220AB



ISOWATT220AB

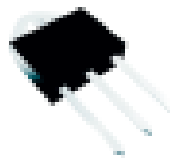

TOP3



RD 91

TRIACs

Standard Triacs (Tj max = 125°C)

The standard TRIACs are ideal for general purpose switching and phase control applications. Available with various gate sensitivities to fit many application requirements, they are used either as ON/OFF switches (in applications like washing machines, solid state relays, food processors...), or as variable load controllers (like in light dimmers, variable speed fans, electric tools...).

IT(RMS)	VRRM VDRM	Part Number	ITSM* (1)	IGT*		VTM* @ ITM		(dV/dt)c min	dV/dt min	Package
				(I - > III)	(IV)	(V)	(A)			
				max (mA)		(V)	(A)			
0.8 Amps	600	Z00607MA	9	5	7	1.5	1.1	1.5	10	T0-92
1 Amps	600	Z0103MA	8	3	5	1.6	1.4	0.5	10	T0-92
		Z0103MN	8	3	5	1.6	1.4	0.5	10	SOT-223
		Z0107MA	8	5	7	1.6	1.4	1	20	T0-92
		Z0107MN	8	5	7	1.6	1.4	1	20	SOT-223
		Z0109MA	8	10	10	1.6	1.4	2	50	T0-92
		Z0109MN	8	10	10	1.6	1.4	2	50	SOT-223
		Z0110MA	8	25	25	1.6	1.4	5	100	T0-92
		Z0110MN	8	25	25	1.6	1.4	5	100	SOT-223
	700	Z0103SA	8	3	5	1.6	1.4	0.5	10	T0-92
		Z0103SN	8	3	5	1.6	1.4	0.5	10	SOT-223
		Z0107SA	8	5	7	1.6	1.4	1	20	T0-92
		Z0107SN	8	5	7	1.6	1.4	1	20	SOT-223
		Z0109SA	8	10	10	1.6	1.4	2	50	T0-92
		Z0109SN	8	10	10	1.6	1.4	2	50	SOT-223
		Z0110SA	8	25	25	1.6	1.4	5	100	T0-92
		Z0110SN	8	25	25	1.6	1.4	5	100	SOT-223
	800	Z0103NA	8	3	5	1.6	1.4	0.5	10	T0-92
		Z0103NN	8	3	5	1.6	1.4	0.5	10	SOT-223
		Z0107NA	8	5	7	1.6	1.4	1	20	T0-92
		Z0107NN	8	5	7	1.6	1.4	1	20	SOT-223
		Z0109NA	8	10	10	1.6	1.4	2	50	T0-92
		Z0109NN	8	10	10	1.6	1.4	2	50	SOT-223
		Z0110NA	8	25	25	1.6	1.4	5	100	T0-92
		Z0110NN	8	25	25	1.6	1.4	5	100	SOT-223
4 Amps	600	BTB04-600SL	35	10	25	1.5	5	10	75	T0-220AB
		T405Q-600B	35	5	10	1.5	5	2	10	DPAK
		T405Q-600H	35	5	10	1.5	5	2	10	IPAK
		Z0402MF	20	3	3	2	5.5	0.5	100	T0202-3
		Z0405MF	20	5	5	2	5.5	1	20	T0202-3
		Z0409MF	20	10	10	2	5.5	2	100	T0202-3
	700	Z0410MF	20	25	25	2	5.5	5	200	T0202-3
		Z0402SF	20	3	3	2	5.5	0.5	100	T0202-3
		Z0405SF	20	5	5	2	5.5	1	20	T0202-3
		Z0409SF	20	10	10	2	5.5	2	100	T0202-3
		Z0410SF	20	25	25	2	5.5	5	200	T0202-3
		800	Z0402NF	20	3	3	2	5.5	0.5	100
	Z0405NF		20	5	5	2	5.5	1	20	T0202-3
	Z0409NF		20	10	10	2	5.5	2	100	T0202-3
Z0410NF	20		25	25	2	5.5	5	200	T0202-3	

(*) ITSM, IGT and VTM specified at Tj = 25°C

(1) tp = 20ms

Note 1: M suffix = 600V, S suffix = 700V, N suffix = 800V

Note 2: 2500VRMS insulation voltage - UL recognized file # E81734

NEW PRODUCT

TRIACs

Standard Triacs (Tj max = 125°C)

IT(RMS)	VRRM VDRM	Part Number	ITSM* (1)	IGT*		VTM* @ ITM		(dV/dt)c min	dV/dt min	Package
				(I - > III)	(IV)	(V)	(A)			
				max (mA)		(V)	(A)			
6 Amps	600	BTA06-600B	60	50	100	1.55	8.5	10	400	TO-220AB Ins.
		BTA06-600C	60	25	50	1.55	8.5	5	200	TO-220AB Ins.
		BTB06-600B	60	50	100	1.55	8.5	10	400	TO-220AB
		BTB06-600C	60	25	50	1.55	8.5	5	200	TO-220AB
	800	BTA06-800B	60	50	100	1.55	8.5	10	400	TO-220AB Ins.
		BTA06-800C	60	25	50	1.55	8.5	5	200	TO-220AB Ins.
		BTB06-800B	60	50	100	1.55	8.5	10	400	TO-220AB
8 Amps	600	BTA08-600B	80	50	100	1.55	11	10	400	TO-220AB Ins.
		BTA08-600C	80	25	50	1.55	11	5	200	TO-220AB Ins.
		BTB08-600B	80	50	100	1.55	11	10	400	TO-220AB
		BTB08-600C	80	25	50	1.55	11	5	200	TO-220AB
	800	BTA08-800B	80	50	100	1.55	11	10	400	TO-220AB Ins.
		BTA08-800C	80	25	50	1.55	11	5	200	TO-220AB Ins.
		BTB08-800B	80	50	100	1.55	11	10	400	TO-220AB
10 Amps	600	BTA10-600B	100	50	100	1.55	14	10	400	TO-220AB Ins.
		BTA10-600C	100	25	50	1.55	14	5	200	TO-220AB Ins.
		BTB10-600B	100	50	100	1.55	14	10	400	TO-220AB
		BTB10-600C	100	25	50	1.55	14	5	200	TO-220AB
	800	BTA10-800B	100	50	100	1.55	14	10	400	TO-220AB Ins.
		BTA10-800C	100	25	50	1.55	14	5	200	TO-220AB Ins.
		BTB10-800B	100	50	100	1.55	14	10	400	TO-220AB
12 Amps	600	BTA12-600B	120	50	100	1.55	17	10	400	TO-220AB Ins.
		BTA12-600C	120	25	50	1.55	17	5	200	TO-220AB Ins.
		BTB12-600B	120	50	100	1.55	17	10	400	TO-220AB
		BTB12-600C	120	25	50	1.55	17	5	200	TO-220AB
	800	BTA12-800B	120	50	100	1.55	17	10	400	TO-220AB Ins.
		BTA12-800C	120	25	50	1.55	17	5	200	TO-220AB Ins.
		BTB12-800B	120	50	100	1.55	17	10	400	TO-220AB
16 Amps	600	BTA16-600B	160	50	100	1.55	22.5	10	400	TO-220AB Ins.
		BTA16-600C	160	25	50	1.55	22.5	5	200	TO-220AB Ins.
		BTB16-600B	160	50	100	1.55	22.5	10	400	TO-220AB
		BTB16-600C	160	25	50	1.55	22.5	5	200	TO-220AB
	800	BTA16-800B	160	50	100	1.55	22.5	10	400	TO-220AB Ins.
		BTA16-800C	160	25	50	1.55	22.5	5	200	TO-220AB Ins.
		BTB16-800B	160	50	100	1.55	22.5	10	400	TO-220AB
25 Amps	600	BTA25-600B	250	50	100	1.55	35	10	500	RD91
		BTA26-600B	250	50	100	1.55	35	10	500	TOP3 Ins.
		BTB24-600B	250	50	100	1.55	35	10	500	TO-220AB
		BTB26-600B	250	50	100	1.55	35	10	500	TOP3 Ins.
	800	BTA25-800B	250	50	100	1.55	35	10	500	RD91
		BTA26-800B	250	50	100	1.55	35	10	500	TOP3
		BTB24-800B	250	50	100	1.55	35	10	500	TO-220AB
40 Amps	600	BTA40-600B	400	50	100	1.55	60	10	500	RD91
		BTA41-600B	400	50	100	1.55	60	10	500	TOP3 Ins.
		BTB41-600B	400	50	100	1.55	60	10	500	TOP3 Ins.
	800	BTA40-800B	400	50	100	1.55	60	10	500	RD91
		BTA41-800B	400	50	100	1.55	60	10	500	TOP3 Ins.
BTB41-800B	400	50	100	1.55	60	10	500	TOP3 Ins.		

(*) ITSM, IGT and VTM specified at Tj = 25°C

(1) tp = 20ms

Note 1: 2500VRMS insulation voltage - UL recognized file # E81734

NEW PRODUCT



TRIACs

Snubberless™ and Logic Level Triacs

The Snubberless™ TRIACs series has been developed to provide very high switching performances while keeping a low gate current drive. They are altogether recommended for highly inductive loads like motor controls and solid state relays, where switching conditions are particularly critical. Snubberless™ TRIACs also bring great improvement in noise immunity characteristics. Logic Level TRIACs are based on the same principle and offer a very low gate current drive ($\leq 10\text{mA}$), allowing direct drive by microcontrollers.

$I_{T(RMS)}$ (A)	V_{RRM} V_{DRM} (V)	Part Number	$I_{TSM}^{*(1)}$ (A)	$I_{GT}^{*(2)}$ max (I - > III) (mA)	$V_{TM}^{* @}$ I_{TM} (V)	$(di/dt)_c$ min. (A/ms)	dV/dt min. @ T_j max (V/ μ s)	Package		
4 Amps	600	T405-600B	30	5	1.6	5.5	0.9	20	DPAK	
		T405-600H	30	5	1.6	5.5	0.9	20	IPAK	
		T405-600T	30	5	1.6	5.5	0.9	20	TO-220AB	
		T405-600W	30	5	1.6	5.5	0.9	20	ISOWATT220AB	
		T410-600B	30	10	1.6	5.5	2	40	DPAK	
		T410-600H	30	10	1.6	5.5	2	40	IPAK	
		T410-600T	30	10	1.6	5.5	2	40	TO-220AB	
		T410-600W	30	10	1.6	5.5	2	40	ISOWATT220AB	
		T435-600B	30	35	1.6	5.5	2.5	400	DPAK	
		T435-600H	30	35	1.6	5.5	2.5	400	IPAK	
		T435-600T	30	35	1.6	5.5	2.5	400	TO-220AB	
		T435-600W	30	35	1.6	5.5	2.5	400	ISOWATT220AB	
	600	T405-700B	30	5	1.6	5.5	0.9	20	DPAK	
		T405-700H	30	5	1.6	5.5	0.9	20	IPAK	
		T405-700T	30	5	1.6	5.5	0.9	20	TO-220AB	
		T405-700W	30	5	1.6	5.5	0.9	20	ISOWATT220AB	
		T410-700B	30	10	1.6	5.5	2	40	DPAK	
		T410-700H	30	10	1.6	5.5	2	40	IPAK	
		T410-700T	30	10	1.6	5.5	2	40	TO-220AB	
		T410-700W	30	10	1.6	5.5	2	40	ISOWATT220AB	
		T435-700B	30	35	1.6	5.5	2.5	400	DPAK	
		T435-700H	30	35	1.6	5.5	2.5	400	IPAK	
		T435-700T	30	35	1.6	5.5	2.5	400	TO-220AB	
		T435-700W	30	35	1.6	5.5	2.5	400	ISOWATT220AB	
	800	T405-800B	30	5	1.6	5.5	0.9	20	DPAK	
		T405-800H	30	5	1.6	5.5	0.9	20	IPAK	
		T405-800T	30	5	1.6	5.5	0.9	20	TO-220AB	
		T405-800W	30	5	1.6	5.5	0.9	20	ISOWATT220AB	
		T410-800B	30	10	1.6	5.5	2	40	DPAK	
		T410-800H	30	10	1.6	5.5	2	40	IPAK	
		T410-800T	30	10	1.6	5.5	2	40	TO-220AB	
		T410-800W	30	10	1.6	5.5	2	40	ISOWATT220AB	
		T435-800B	30	35	1.6	5.5	2.5	400	DPAK	
		T435-800H	30	35	1.6	5.5	2.5	400	IPAK	
		T435-800T	30	35	1.6	5.5	2.5	400	TO-220AB	
		T435-800W	30	35	1.6	5.5	2.5	400	ISOWATT220AB	
	6 Amps	600	BTA06-600BW	60	50	1.55	8.5	5.3	1000	TO-220AB Ins.
			BTA06-600CW	60	35	1.55	8.5	3.5	400	TO-220AB Ins.
			BTA06-600SW	60	10	1.55	8.5	2.4	40	TO-220AB Ins.
			BTA06-600TW	60	5	1.55	8.5	1.2	20	TO-220AB Ins.
			BTB06-600BW	60	50	1.55	8.5	5.3	1000	TO-220AB
			BTB06-600CW	60	35	1.55	8.5	3.5	400	TO-220AB
			BTB06-600SW	60	10	1.55	8.5	2.4	40	TO-220AB
			BTB06-600TW	60	5	1.55	8.5	1.2	20	TO-220AB

(*) I_{TSM} , I_{GT} and V_{TM} specified at $T_j = 25^\circ\text{C}$

(1) $t_p = 20$ ms

(2) Quadrant IV operation not accessible on Snubberless triacs

Note 1: 2500V_{RMS} insulation voltage - UL recognized file # E81734

NEW PRODUCT



TRIACs

Snubberless™ and Logic Level Triacs

IT(RMS)	VRRM VDRM	Part Number	ITSM* (1)	IGT*(2) max (I - > III)	VTM* @ ITM		(di/dt)c min.	dV/dt min. @ Tj max	Package
(A)	(V)		(A)	(mA)	(V)	(A)	(A/ms)	(V/μs)	
6 Amps	600	T620-600W	80	20	1.4	8.5	3.3	300	ISOWATT220AB
		T630-600W	80	30	1.4	8.5	4.5	500	ISOWATT220AB
	800	BTA06-800BW	60	50	1.55	8.5	5.3	1000	TO-220AB Ins.
		BTA06-800CW	60	35	1.55	8.5	3.5	400	TO-220AB Ins.
		BTA06-800SW	60	10	1.55	8.5	2.4	40	TO-220AB Ins.
		BTA06-800TW	60	5	1.55	8.5	1.2	20	TO-220AB Ins.
		BTA06-800BW	60	50	1.55	8.5	5.3	1000	TO-220AB
		BTA06-800CW	60	35	1.55	8.5	3.5	400	TO-220AB
		BTA06-800SW	60	10	1.55	8.5	2.4	40	TO-220AB
		BTA06-800TW	60	5	1.55	8.5	1.2	20	TO-220AB
T630-800W	80	20	1.4	8.5	3.3	300	ISOWATT220AB		
T630-800W	80	30	1.4	8.5	4.5	500	ISOWATT220AB		
8 Amps	600	BTA08-600BW	80	50	1.55	8.5	7	1000	TO-220AB Ins.
		BTA08-600CW	80	35	1.55	8.5	4.5	400	TO-220AB Ins.
		BTA08-600SW	80	10	1.55	8.5	2.8	40	TO-220AB Ins.
		BTA08-600TW	80	5	1.55	8.5	1.5	20	TO-220AB Ins.
		BTB08-600BW	80	50	1.55	8.5	7	1000	TO-220AB
		BTB08-600CW	80	35	1.55	8.5	4.5	400	TO-220AB
		BTB08-600SW	80	10	1.55	8.5	2.8	40	TO-220AB
		BTB08-600TW	80	5	1.55	8.5	1.5	20	TO-220AB
		T810-600B	80	10	1.55	8.5	2.8	40	DPAK
		T810-600H	80	10	1.55	8.5	2.8	40	IPAK
		T835-600B	80	35	1.55	11	4.5	400	DPAK
		T835-600G	80	35	1.55	11	4.5	400	D ² PAK
		T835-600H	80	35	1.55	11	4.5	400	IPAK
		T820-600W	100	20	1.4	11	4.5	300	ISOWATT220AB
	T830-600W	100	30	1.4	11	4.5	500	ISOWATT220AB	
	800	BTA08-800BW	80	50	1.55	11	7	1000	TO-220AB Ins.
		BTA08-800CW	80	35	1.55	11	4.5	400	TO-220AB Ins.
		BTA08-800SW	80	10	1.55	11	2.8	40	TO-220AB Ins.
		BTA08-800TW	80	5	1.55	11	1.5	20	TO-220AB Ins.
		BTB08-800BW	80	50	1.55	11	7	1000	TO-220AB
		BTB08-800CW	80	35	1.55	11	4.5	400	TO-220AB
		BTB08-800SW	80	10	1.55	11	2.8	40	TO-220AB
		BTB08-800TW	80	5	1.55	11	1.5	20	TO-220AB
		T810-800B	80	10	1.55	11	2.8	40	DPAK
		T810-800H	80	10	1.55	11	5.4	40	IPAK
		T835-800B	80	35	1.55	11	4.5	400	DPAK
T835-800G		80	35	1.55	11	4.5	400	D ² PAK	
T835-800H	80	35	1.55	11	4.5	400	IPAK		
T820-800W	100	20	1.4	11	4.5	300	ISOWATT220AB		
T830-800W	100	30	1.4	11	4.5	500	ISOWATT220AB		
10 Amps	600	BTA10-600BW	100	50	1.55	14	9	1000	TO-220AB Ins.
		BTA10-600CW	100	35	1.55	14	5.5	500	TO-220AB Ins.
		BTB10-600BW	100	50	1.55	14	9	1000	TO-220AB
		BTB10-600CW	100	35	1.55	14	5.5	500	TO-220AB
		T1020-600W	120	20	1.4	14	5.5	300	ISOWATT220AB
	T1030-600W	120	30	1.4	14	6.5	500	ISOWATT220AB	
	800	BTA10-800BW	100	50	1.55	14	9	1000	TO-220AB Ins.
		BTA10-800CW	100	35	1.55	14	5.5	500	TO-220AB Ins.
		BTB10-800BW	100	50	1.55	14	9	1000	TO-220AB
		BTB10-800CW	100	35	1.55	14	5.5	500	TO-220AB
T1020-800W		120	20	1.4	14	5.5	500	ISOWATT220AB	
T1030-800W	120	30	1.4	14	6.5	500	ISOWATT220AB		

(*) ITSM, IGT and VTM specified at Tj = 25°C

(1) tp = 20 ms

(2) Quadrant IV operation not accessible on Snubberless triacs

Note 1: 2500VRRM insulation voltage - UL recognized file # E81734

NEW PRODUCT



TRIACs

Snubberless™ and Logic Level Triacs

I_T (RMS)	V_{RRM} V_{DRM}	Part Number	$I_{TSM}^{*(1)}$	$I_{GT}^{*(2)}$ max (I - > III)	V_{TM}^{*} @ I_{TM}	$(dl/dt)_c$ min.	dV/dt min. @ T_j max	Package	
(A)	(V)		(A)	(mA)	(V)	(A/ms)	(V/μs)		
12 Amps	600	BTA12-600BW	120	50	1.55	17	12	1000	TO-220AB Ins.
		BTA12-600CW	120	35	1.55	17	6.5	500	TO-220AB Ins.
		BTA12-600SW	120	10	1.55	17	2.9	40	TO-220AB Ins.
		BTA12-600TW	120	5	1.55	17	3.5	20	TO-220AB Ins.
		BTB12-600BW	120	50	1.55	17	12	1000	TO-220AB
		BTB12-600CW	120	35	1.55	17	6.5	500	TO-220AB
		BTB12-600SW	120	10	1.55	17	2.9	40	TO-220AB
		BTB12-600TW	120	5	1.55	17	3.5	20	TO-220AB
		T1220-600W	120	20	1.4	17	6.5	300	ISOWATT220AB
	T1230-600W	120	30	1.4	17	6.5	500	ISOWATT220AB	
	T1235-600G	120	35	1.55	17	6.5	500	D ² PAK	
	800	BTA12-800BW	120	50	1.55	17	12	1000	TO-220AB Ins.
		BTA12-800CW	120	35	1.55	17	6.5	500	TO-220AB Ins.
		BTA12-800SW	120	10	1.55	17	2.9	40	TO-220AB Ins.
		BTB12-800BW	120	50	1.55	17	12	1000	TO-220AB
		BTB12-800CW	120	35	1.55	17	6.5	500	TO-220AB
		BTB12-800SW	120	10	1.55	17	2.9	40	TO-220AB
		T1220-800W	120	20	1.4	17	6.5	300	ISOWATT220AB
T1230-800W		120	30	1.4	17	6.5	500	ISOWATT220AB	
T1235-800G		120	35	1.55	17	6.5	500	D ² PAK	
16 Amps	600	BTA16-600BW	160	50	1.55	22.5	14	1000	TO-220AB Ins.
		BTA16-600CW	160	35	1.55	22.5	8.5	500	TO-220AB Ins.
		BTA16-600SW	160	10	1.55	22.5	3	40	TO-220AB Ins.
		BTB16-600BW	160	50	1.55	22.5	14	1000	TO-220AB
		BTB16-600CW	160	35	1.55	22.5	8.5	500	TO-220AB
		BTB16-600SW	160	10	1.55	22.5	3	40	TO-220AB
		T1620-600W	200	20	1.4	22.5	8.5	300	ISOWATT220AB
		T1630-600W	200	30	1.4	22.5	11	500	ISOWATT220AB
		T1635-600G	160	35	1.55	22.5	8.5	500	D ² PAK
	800	BTA16-800BW	160	50	1.55	22.5	14	1000	TO-220AB Ins.
		BTA16-800CW	160	35	1.55	22.5	8.5	500	TO-220AB Ins.
		BTA16-800SW	160	10	1.55	22.5	3	40	TO-220AB Ins.
		BTB16-800BW	160	50	1.55	22.5	14	1000	TO-220AB
		BTB16-800CW	160	35	1.55	22.5	8.5	500	TO-220AB
		BTB16-800SW	160	10	1.55	22.5	3	40	TO-220AB
		T1620-800W	200	20	1.4	22.5	8.5	300	ISOWATT220AB
		T1630-800W	200	30	1.4	22.5	11	500	ISOWATT220AB
		T1635-600G	160	35	1.55	22.5	8.5	500	D ² PAK
25 Amps	600	BTA24-600BW	250	50	1.55	35	22	1000	TO-220AB Ins.
		BTA24-600CW	250	35	1.55	35	13	500	TO-220AB Ins.
		BTA25-600BW	250	50	1.55	35	22	1000	RD91
		BTA25-600CW	250	35	1.55	35	13	500	RD91
		BTA26-600BW	250	50	1.55	35	22	1000	TOP3 Ins.
		BTA26-600CW	250	35	1.55	35	13	500	TOP3 Ins.
		BTB24-600BW	250	50	1.55	35	22	1000	TO-220AB
		BTB24-600CW	250	35	1.55	35	13	500	TO-220AB
		T2535-600G	250	35	1.55	35	13	500	D ² PAK
	800	BTA24-800BW	250	50	1.55	35	22	1000	TO-220AB Ins.
		BTA24-800CW	250	35	1.55	35	13	500	TO-220AB Ins.
		BTA25-800BW	250	50	1.55	35	22	1000	RD91
		BTA25-800CW	250	35	1.55	35	13	500	RD91
		BTA26-800BW	250	50	1.55	35	22	1000	TOP3 Ins.
		BTA26-800CW	250	35	1.55	35	13	500	TOP3 Ins.
		BTB24-800BW	250	50	1.55	35	22	1000	TO-220AB
		BTB24-800CW	250	35	1.55	35	13	500	TO-220AB
		T2535-800G	250	35	1.55	35	13	500	D ² PAK

(*) I_{TSM} , I_{GT} and V_{TM} specified at $T_j = 25^\circ\text{C}$

(1) $t_p = 20$ ms

(2) Quadrant IV operation not accessible on Snubberless triacs

Note 1: 2500V_{RMS} insulation voltage - UL recognized file # E81734

NEW PRODUCT



TRIACs

High Temperature Triacs ($T_j \text{ max} = 150^\circ\text{C}$) - Snubberless

Specifically designed to work in **high temperature environments** (found in "hot appliances" such as cookers, ovens, hobs, electric heaters, coffee machines...) the new high temperature TRIACs provide enhanced performance in terms of power losses and thermal dissipation. This allows optimization of the heatsink dimensioning, leading to PCB space reduction and cost effectiveness for the designer.

$I_{T(RMS)}$ (A)	V_{RRM} V_{DRM} (V)	Part Number	T_C ($^\circ\text{C}$)	$I_{TSM}^{*(1)}$ (A)	I_{GT}^* max (I - > III) (mA)	V_{TM}^* @ I_{TM} (V) (A)		$(di/dt)_C$ min (A/ms)	$R_{th(j-c)}$ max ($^\circ\text{C}/\text{W}$)	Package
12 Amps	600	T1235H-600G	135	140	35	1.5	17	5.3	1.2	D ² PAK
		T1235H-600T	135	140	35	1.5	17	5.3	1.2	TO-220AB
25 Amps		T2550H-600T	125	250	50	1.5	35	11.1	0.8	TO-220AB

(*) I_{TSM} , I_{GT} and V_{TM} specified at $T_j = 25^\circ\text{C}$

(1) $t_p = 20 \text{ ms}$

Note 1: 2500V_{RMS} insulation voltage - UL recognized file # E81734

NEW PRODUCT

DIACs

Bi-directional Diode Thyristor

DIACs are used as a trigger diode with a fixed voltage reference. They are mainly used in light dimmer, power tools, vacuum cleaners applications in conjunction with TRIACs, or in starter circuit for fluorescent lamp ballasts.

Typical I/V Characteristic of a diac

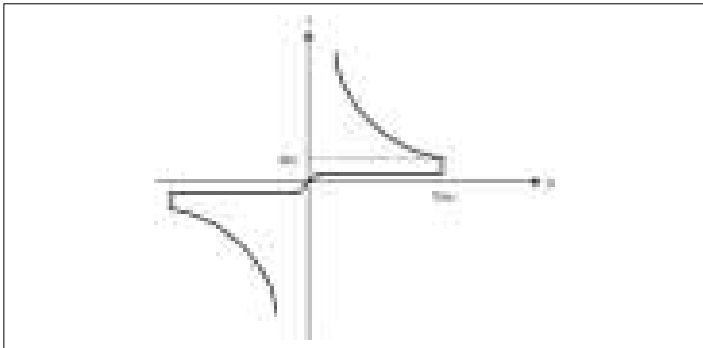

Diac Symbol

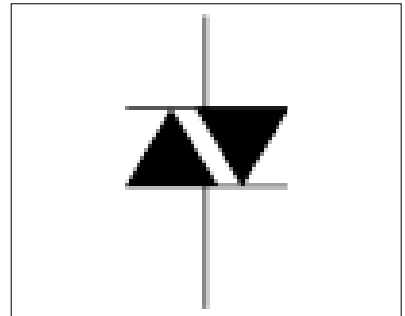

CFL & Electronic Ballasts

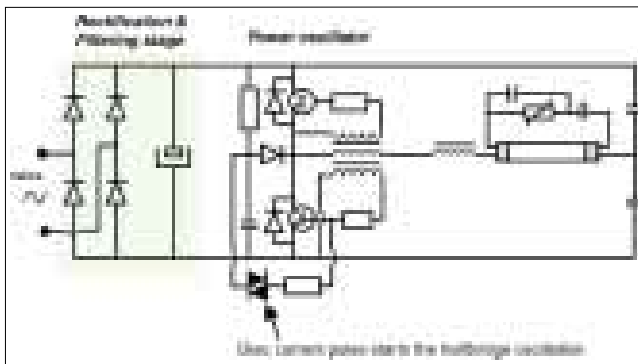

Light Dimmers

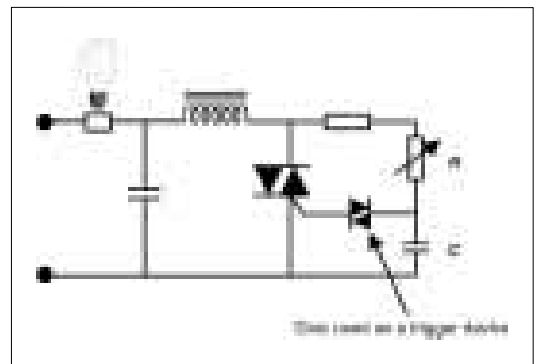

DO-35



SOT-23

Part Number	V _{BO}			V _{BO} symmetry (V)	I _{B0} max (μA)	ΔV (dynamic V _{BO}) (V)	Package
	min(V)	typ(V)	max(V)				
DB3	28	32	36	±3	50	5	DO-35
DB3TG	30	32	34	±2	15	9	DO-35
DB4	35	40	45	±3	50	5	DO-35
SMDB3	28	32	36	±3	10	10	SOT-23

NEW PRODUCT



IGNITORS for Industrial Applications

Control Circuit for Gas Hobs, Fuel Ignition, Electrical Fence

Fire Lighter Circuits have been developed for systems with gas ignition like furnaces, boilers, fuel control ignition, gas ranges, barbecues... They are based on spark generation through capacitive discharge mode and provide high pulse and high noise immunity level in a fully integrated solution.

AC operation example

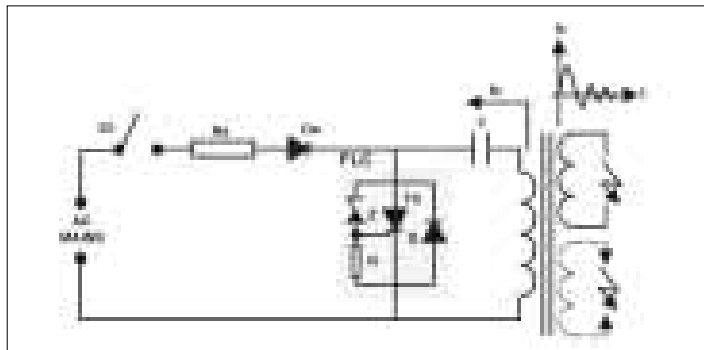

DC operation example



TO-92



IPAK



DPAK

Part Number	Voltage Source (V)	V_{BO}		Peak Current @ 10 μ s (A)	Package
		min (V)	max (V)		
FLC01-200B	220V AC	206	233	190	DPAK
FLC01-200H	220V AC	206	233	190	IPAK
FLC10-200B	220V AC	206	233	240	DPAK
FLC10-200H	220V AC	206	233	240	IPAK
FLC21-135A	DC Battery	140	160	90	TO-92

NEW PRODUCT



IGNITORS for Lighting Applications

Fluorescent Tube Starter

The TN22/P01 combination is specifically intended for use in fluorescent tube ignition starters. Thanks to the high voltage capability of the TN22 coupled with the very sensitive P01 pilot SCR, this circuit kit provides high energy striking capabilities with low triggering power.

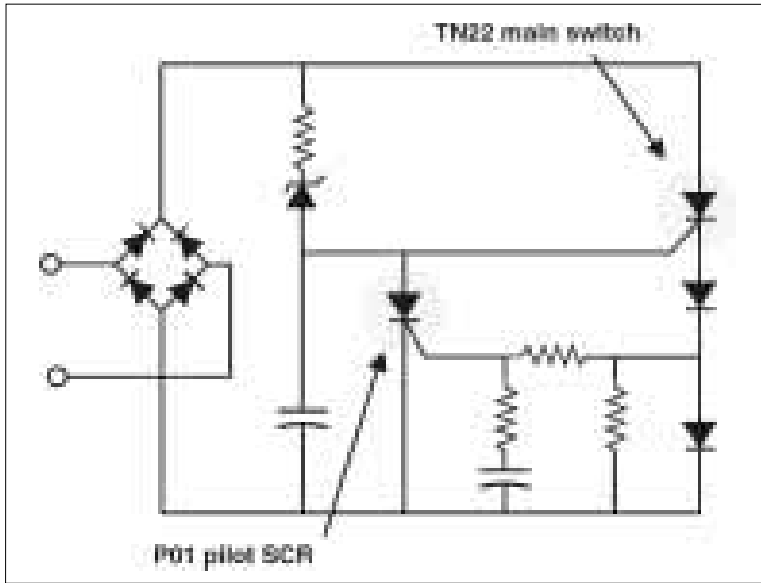

DPAK



TO-92

Starlight

$I_{T(RMS)}$	V_{RRM} V_{DRM}	Part Number	$I_{TSM}^{*(1)}$	I_{GT}^{*} max	I_H^{*} max	V_{TM}^{*} @	I_{TM}	dV/dt min. @ T_j max	Package
	(V)		(A)	(μ A)	(mA)	(V)	(A)	(V/ μ s)	
0,8 Amps	400	P0130AA	7	5	1	1.25	0.5	25	TO-92
2 Amps	400	TN22-1500B	1.5	1500	175	3.1	2	500	DPAK
		TN22-1500H							IPAK

(*) I_{TSM} , I_{GT} , I_H and V_{TM} specified at $T_j = 25^\circ\text{C}$

(1) $t_p = 20$ ms

NEW PRODUCT

IGNITORS for Lighting Applications

LIC Series - High Intensity Discharge Lamp Starter

The **LIC series** is the core of electronic superimposed ignitors for high intensity discharge lamps supplied by magnetic ballasts. The main applications are outdoor, street or building lighting fixtures using high pressure Sodium or Metal Halide lamps. The LIC devices provide a high pulse current capability and a low holding current, to secure the lamp ignition with multi-pulse striking. Compared with the conventional solution, they offer a high reliability level and space saving as it is a stand-alone circuit.

LICO1 typical application

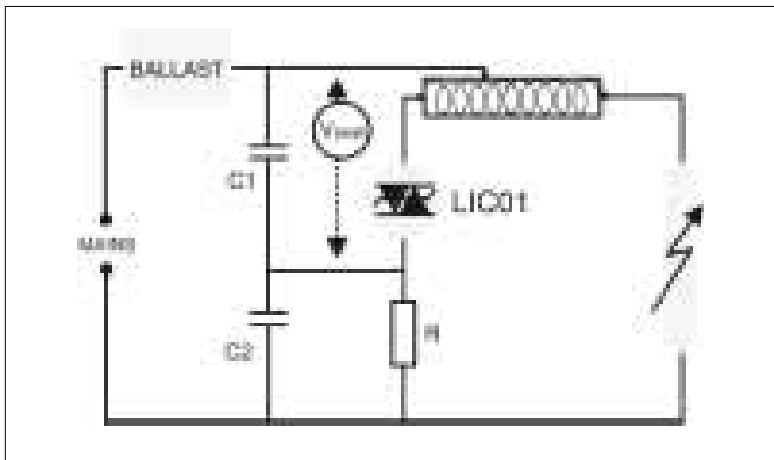

DPAK



IPAK

Part Number	$V_{BO\ min}$ (V)	$V_{BO\ max}$ (V)	Peak Pulse current @10 μ s (A)	$I_H\ min$ (mA)	$di/dt\ max$ (A/ μ s)	Package
LIC01-215B	215	255	50	50	80	DPAK
LIC01-215H						IPAK

NEW PRODUCT

AC Switches

ACS™ and ACST Devices for Home Appliances

The ACS series is a new generation of switches specifically developed for home appliances and industrial processing applications. Thanks to their embedded overvoltage protection and integrated level shifter, they do not require external voltage protection such as MOV, provide high reliability level to safely sustain AC transients (as defined in IEC61000 standards), have superior performance in noise immunity thanks to ultra high dV/dt and are easy to drive directly from microprocessors. The ACST series embeds the overvoltage protection structure of the ACS and extends the AC Switch family to the 8A and 800V ranges.

ACSxx: High voltage ACS™ devices for medium power loads in appliance systems



Main benefits of ACS & ACST technology

No more external MOV

- ACS = Protected structure

No more Snubber circuit

- Thanks to high dV/dt

Resists Line Transients

- Complies with IEC61000-4-5 standard

Simplified Gate drive

- No buffer interface needed
- Suppression of "kick-back" effect

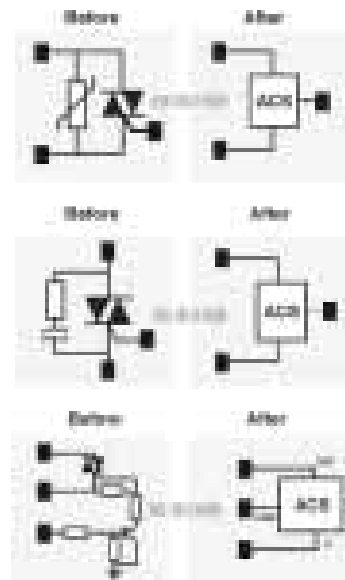

AC Switches

ACST[™] and ACST Devices for Home Appliances

Typical configuration in washing machine

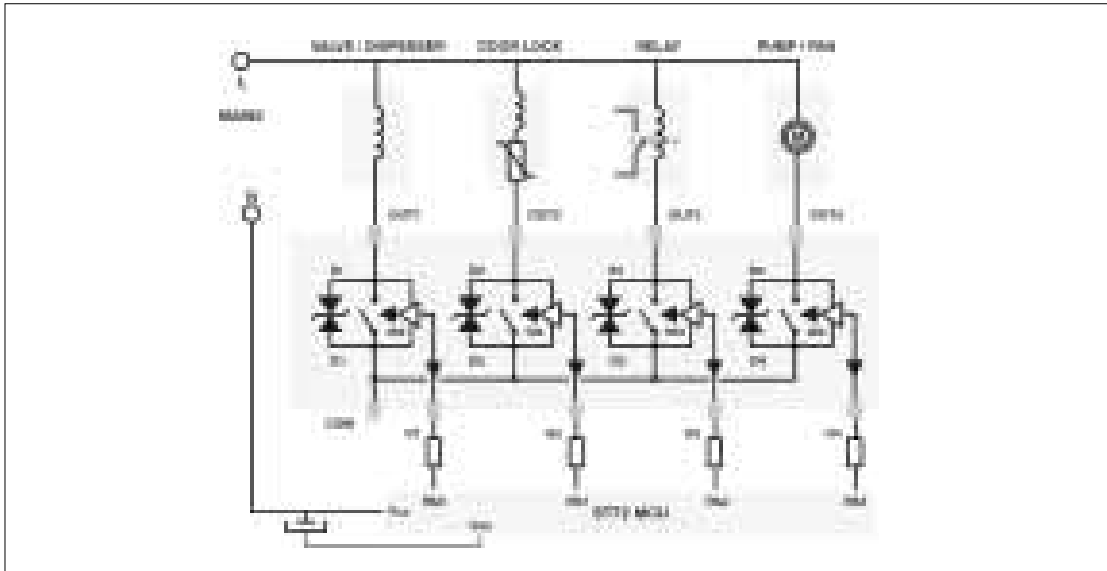

Typical configuration for compressor control in fridge applications

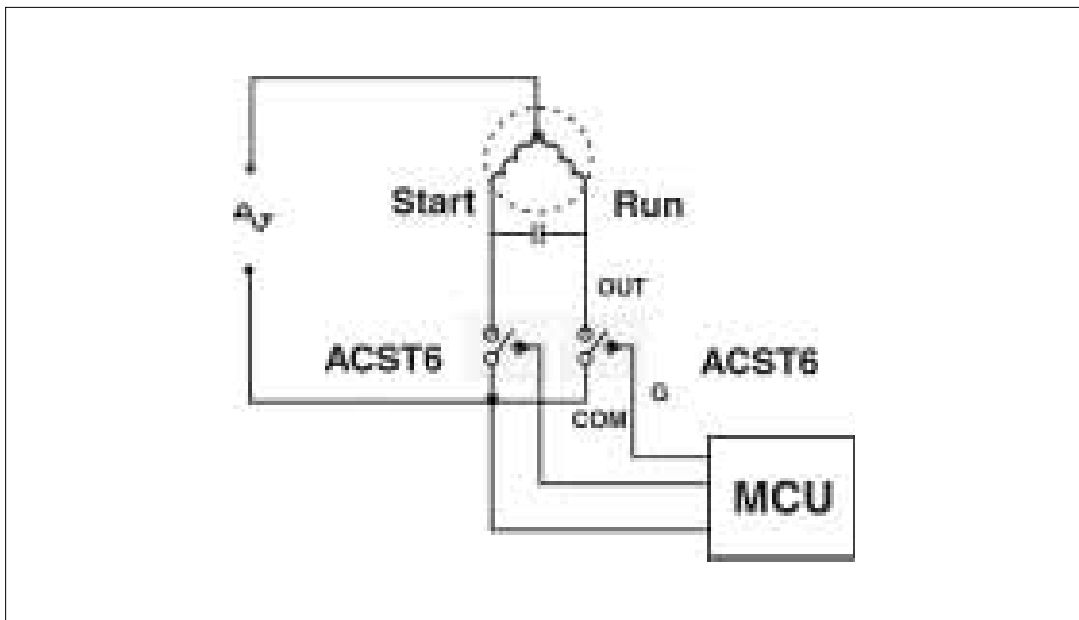

AC Switches

Packages

SMD PACKAGES



SOT-223



SO-8



SO-20



DPAK

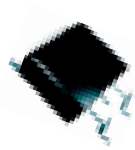

D²PAK

INSERTION PACKAGES



TO-92



DIP-8



DIP-20



TO-220AB



TO-220FPAB

AC Switches

ACS™ and ACST Devices for Home Appliances

V_{RRM} V_{DRM} (V)	I_T (RMS) (A)	Part Number	$V_{CL@1mA}$ Typ ⁽¹⁾ (V)	I_{GT}^* max (mA)	V_{TM}^* @ I_{TM} (V) (A)		(di/dt) _c (A/ms)	dV/dt min. (V/μs)	Package
500 Amps	0.2	ACS102-5T1	600	5	1.1	0.3	0.1	300	SO-8
		ACS102-5TA	600	5	1.1	0.3	0.1	300	TO-92
	0.8	ACS302-5T3	600	5	1.2	0.3	0.1	300	SO-20
		ACS108-5SA	600	10	1.3	1.1	0.1	500	TO-92
	4x0.2	ACS108-5SN	600	10	1.3	1.1	0.1	500	SOT-223
700 Amps	1	ACS402-5SB4	600	10	1.1	0.3	0.1	500	DIP-20
		ACS110-7SB2	1100	10	1.3	1.4	0.5	500	DIP-8
	2	ACS110-7SN	1100	10	1.3	1.4	0.5	500	SOT-223
		ACS120-7SB	1100	10	1.3	2.8	1	500	DPAK
		ACS120-7SFP	1100	10	1.3	2.8	1	500	TO-220FPAB
	4	ACS120-7SH	1100	10	1.3	2.8	1	500	IPAK
		ACS120-7ST	1100	10	1.3	2.8	1	500	TO-220AB
		ACST4-7CB	1100	25	1.5	5.6	2.5	500	DPAK
		ACST4-7CFP	1100	25	1.5	5.6	2.5	500	TO-220FPAB
		ACST4-7CH	1100	25	1.5	5.6	2.5	500	IPAK
		ACST4-7SB	1100	10	1.5	5.6	2	200	DPAK
		ACST4-7SFP	1100	10	1.5	5.6	2	200	TO-220FPAB
	6	ACST4-7SH	1100	10	1.5	5.6	2	200	IPAK
		ACST6-7SFP	1100	10	1.4	2.1	3	200	TO-220FPAB
		ACST6-7SG	1100	10	1.4	2.1	3	200	D ² PAK
		ACST6-7SR	1100	10	1.4	2.1	3	200	I ² PAK
		ACST6-7ST	1100	10	1.4	2.1	3	200	TO-220AB
800 Amps	8	ACST8-8CFP	1100	30	1.5	11	4.5	500	TO-220FPAB
		ACST8-8CT	1100	30	1.5	11	4.5	500	TO-220AB

(*) IGT and VTM specified at T_J = 25°C

(1) t_p = 1 ms

NEW PRODUCT

ASDs for INDUSTRIAL APPLICATIONS

Inrush Current Limiter Circuit

The **STILO2** is a circuit combining two unidirectional switches for use in a smart configuration of a primary rectification bridge, mixing diode rectification and SCR. Compared to the traditional inrush current limitation circuits, the SCR bridge configuration using the STIL offers reduced power losses and higher efficiency, reduced size, full operation during a.c. ON/ OFF cycles with PFC and absence of hot spots during nominal operation. The STILO2-P5 is dedicated to SMPS with output power up to 100W and the STILO4-P5 to SMPS with output power up to 200W.

STIL Typical application with a rectification SCR Bridge

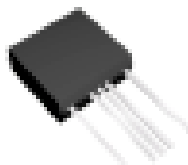
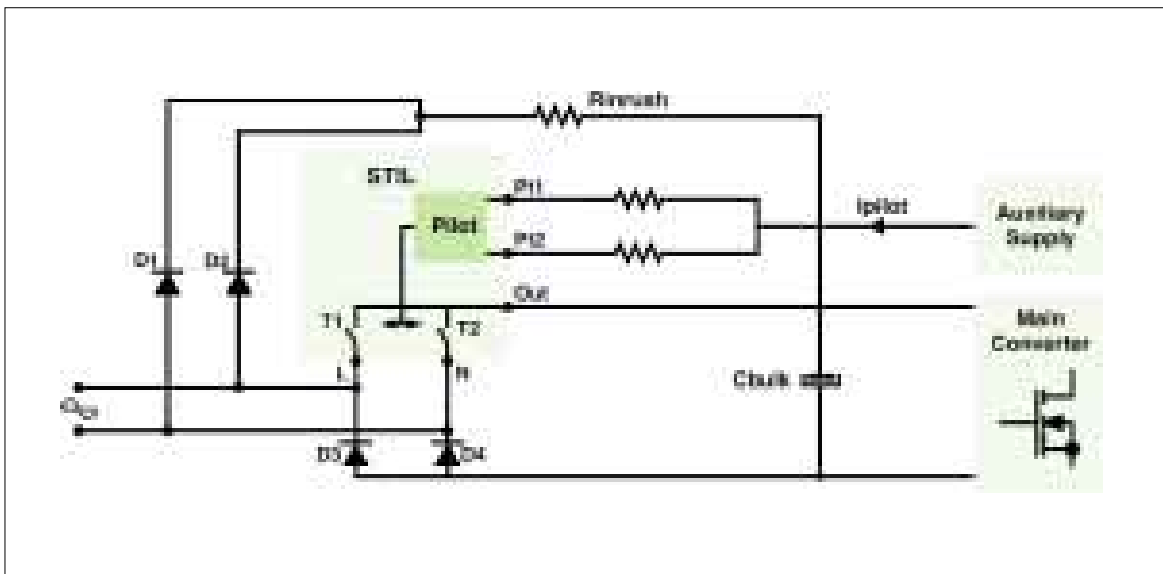

Pentawatt

VDout/VRout (V)	Iout(AV) (A)	Part Number	ITSM* (1) (A)	Ip1+Ip2* typ (mA)	IROUT(on) max (μA)	VF @ Iout (AV) (V)	(A)	dVDout/ dt min @ Tj max (V/μs)	Package
700 Amps	2	STILO2-P5	65	20	500	1.1	2	300	Pentawatt HV2
	4	STILO4-P5							Pentawatt HV2

(*) ITSM and Ip1 + Ip2 specified at Tj = 25°C

(1) tp = 10 ms

NEW PRODUCT

ASDs for INDUSTRIAL APPLICATIONS

Current Limited Overvoltage Protected Quad Digital Termination

The CLT3-4 is a 3mA quadruple input digital termination device designed for 24V DC automation applications. It achieves the compact front-end of a digital input by minimizing the external component count. It reduces the printed board size and the losses in conduction. The current limiting circuit connected between the input and the output pins is compensated over all the temperature range. Its main applications include termination for inputs designed to the IEC61131-2 type 1 standard and for the logic interfaces of EN60947-5-2 proximity sensors. The CLT3-4 will also be useful in the I/O modules of industrial automation modules including PCLs, distributed I/O peripherals, field bus nodes and machine tool interfaces.

CLT3-4BT6 single channel block diagram

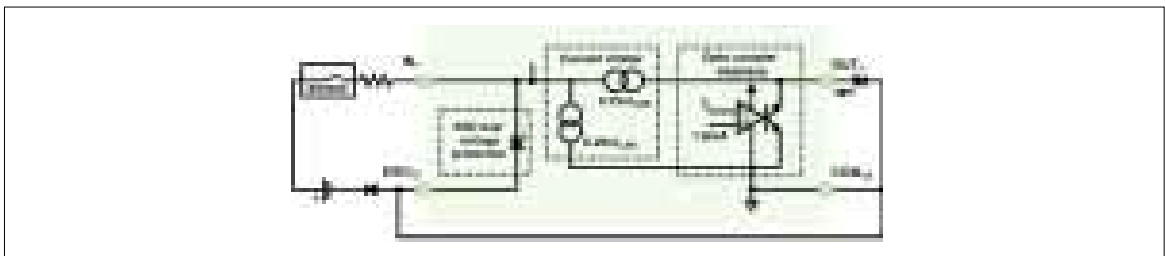

CLT3-4BT6 application diagram

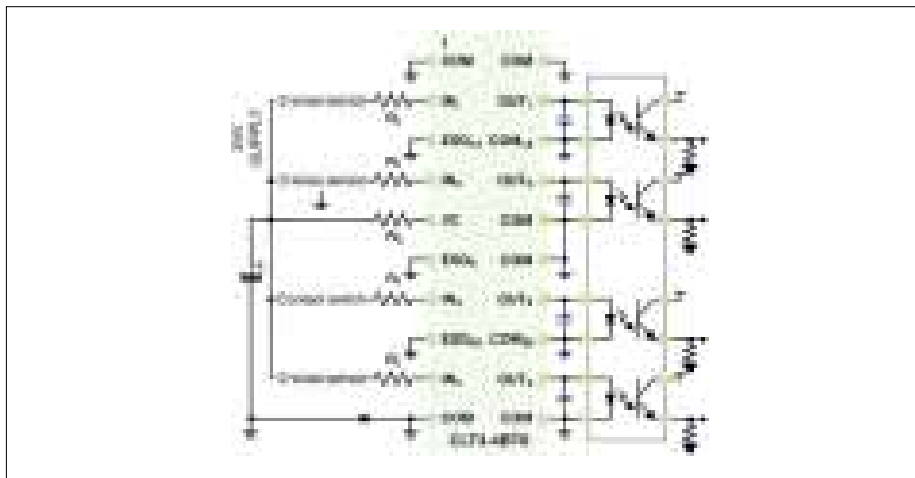

TSSOP20

V _{CC}	V _I	Part Number	I _{LIM} min/max	I _{OFF} /V _{OFF}	ESD in air	Surge 1.2/50 μs	Package
(V)	(A)		(mA)	(mA/V)	(kV)	(kV)	
19 to 35	-30 to +35	CLT3-4BT6	2.1/3.7	1.5/5	±8	1	TSSOP20

NEW PRODUCT



Major Key Applications

Major Home Appliances

APPLICATION	LOAD / FUNCTION	KEY PRODUCTS
Washing Machine		
Drum motor (up to 700W)	Speed control	BTB16-600BW / BTB16-600CW / BTB16-600C
Drum motor (100 to 300W)	Induction motor	ACST8-8CFP / T830-800W / BTA12-800CW
Drain pump (up to 35W)	Synchronous motor	ACS108-5SA / ACS108-5SN / Z01xxMA
Drain pump (50 to 100W)	Asynchronous motor	T405-600H / T410-600H T405-600T / T410-600T / ACS120 / T405-600B / T410-600B / ACST4-7SFP / T435-800W
Drain magnet (up to 50W)	Bridge + Solenoid	T435-600W / ACST4-7SFP
Valves (up to 30W)	Solenoid	ACS108-5SA / ACS402-5SB4 / ACS102-7S / Z01xxMA
Door lock (up to 10W)	Thermal actuator	ACS108-5SA / ACS402-5SB4 / ACS102-7S / Z01xxMA
Water Heater	Temperature control	BTB16-600BW / T2550H-600T
Timer motor	Small synchronous motor	Z01xxMA / ACS108-5SA / ACS102-7S
Dispenser	Solenoid	Z01xxMA / ACS108-5SA / ACS102-7S
Dishwasher		
Recirculation pump (up to 200W)	Induction motor	ACST4-7SFP / T830-800W / BTA08-600CW / BTB08-600CW / BTA08-800CW
Valves (up to 30W)	Solenoid	ACS108-5SA / ACS402-5SB4 / ACS102-7S / Z01xxMA
Drain pump (up to 35W)	Synchronous motor	ACS108-5SA / ACS402-5SB4 / ACS102-7S / Z01xxMA / ACS110 / ACS 120
Water Heater	Heating resistor (Temperature control)	BTB16-600BW
Dispenser	Wax actuator	ACS102-7S
Trumble Dryer		
Drum motor (up to 300W)	Induction motor (ON-OFF / reversing)	T830-800W / BTA08-800CW / ACST8-8CFP / BTA25-600B / BTB41-600B / T2550H-600T
Refrigerator, Freezer, Water dispenser		
Compressor (up to 300W)	Induction motor (ON-OFF control)	ACST6-7ST / BTA08-600SW / BTB08-600W
Fan	Low power induction motor	ACS108-5SA / ACS108-5SN / ACS102-7S / ACS110 / ACS120 / ACS402-5SB4 / ACST4-7S / Z0107MA / Z0409MF / T410-600B / BTB06-600SW / ACST6-7S
Defroster resistor	Heating resistor	ACS108-5SA / ACS108-5SN / ACS302-5T3 / ACS102-7S / ACS402-5SB4 / ACST4-7S / Z0107MA / Z0409MF / T410-600B / BTB06-600SW / ACST6-7S
Lamp	In series with a resistor	ACS108-7S / Z01xxMA
Door Damper	Small induction motor	ACS108-7S / ACS110

NEW PRODUCT

Major Key Applications

Major Home Appliances

APPLICATION	LOAD / FUNCTION	KEY PRODUCTS
Microwave oven		
Power control (Magnetron)	Transformer primary (ON-OFF control)	BTA12-600CW / ACST8-8CFP / T410-600T / BTA12-600CW BTA08-600SW
Rotating plate	Induction motor	T410-600T / ACST4-7S / ACS108-5SN / ACS110 / ACS120
Fan	Induction motor	T410-600T / ACST4-7S
Grill	Temperature control	BTB16-600BW / T2550H-600T
Inside Lamp	Resistor	ACS108-7S
Halogen lamp heating	Resistor	T1235H-600T / BTA12-600B / BTA16-600B / T2550H-600T
Hot Appliances		
Halogen cooktop (upto2kW)	Halogen Temperature Control	T2550H-600T
Oven	Heating resistor (Temperature Control)	T2550H-600T
Fan / Cooker hood	Induction motor	Z01xxMA / Z01xxMN / Z00607MA / Z04xxMF / T4xx-600W / ACS110 / ACS 120
Gas stove	Ignition Spark generation	FLC01-200H / FLC10-200H / FLC21-65A / FLC21-135A
Vaccum cleaner		
Turbine speed control (up to 1200W & 1600W)	Universal motor control (with diac)	BTB12-600BW / BTB16-600W / DB3 / SMDB3
Turbine speed control (up to 1200W & 1600W)	Universal motor control (with MCU)	BTB12-600SW / BTB16-600W

NEW PRODUCT

Major Key Applications

Small appliances

APPLICATION	LOAD / FUNCTION	KEY PRODUCTS
Food processor		
Up to 300W & from 300W to 600W	Speed motor control (DC operation with SCR)	TS420-600B / TS420-600T / TS820-600B / TS820-600T
Up to 800W	Speed motor control (full wave control with triac)	BTB06-600CW / BTB06-600SW / BTB08-600CW / BTB08-600SW / T810-600B
Rice cooker		
Main cooking and slow cooking (200W heater)	Heating resistor (Temperature control)	Z0107MA / Z0107MN / T405-600B / T405-600T / T405-600H / T410-600B / T410-600T / T410-600H / ACST4-7S / T1235H-600T
Bread maker		
Up to 200W	Induction motor control	T830-600W / BTA08-600CW / BTB08-600CW / BTA06-600C / T830-800W / BTA08-800CW / ACST8-8CFP
Coffee maker		
Up to 1.2kW	Heater (Temperature control)	BTB12-600CW / BTB12-600SW / T2550H-600T
Electric tools		
Hand drill (400W to 1200W)	Universal motor control (AC operation with triac)	BTB04-600SL / T405Q-600B/H / BTA06-600BW / BTA06-600CW / BTA12-600BW / BTA12-600CW / BTB06-600BW / BTB06-600CW / BTB12-600BW / BTB12-600CW / T810-600B / T835-600B / T1235-600G / T1635-600G / BTA16-600BW / BTB16-600BW / DB3 / SMDB3
Hand drill (up to 600W)	Universal motor control (half wave control with sensitive SCR)	TS420-600B / TS820-600B / TS1220-600B
Toaster Bug killer Electric kettle Electric blanket Iron Hair dryer		
	Heater (Temperature control)	BTB08-600CW / BTB08-600SW / BTB16-600CW / BTB16-600SW / BTB24-600CW / BTB41-600B / BTA25-600B / T2550H-600T
Sewing machine		
	Speed motor control	ACST6-7S / BTA06-600BW / BTA06-600CW / BTA12-600BW / BTA12-600CW / BTB06-600BW / BTB06-600CW / BTB12-600CW / T810-600B / T835-600B / T1235-600G / T1635-600G / DB3 / SMDB3

NEW PRODUCT

Major Key Applications

Lighting

APPLICATION	LOAD / FUNCTION	KEY PRODUCTS
Dimmer		
Basic light dimmer (60 to 600W)	Bulb lamp control (With diac)	BTA10-600SW / BTA12-600SW / DB3 / SMDB3
Smart light dimmer (60 to 600W)	Bulb lamp control (With MCU)	BTA10-600SW / BTA12-600SW
Touch dimmer (up to 600W)	Bulb lamp control (With MCU)	BTB04-600SL / T405Q-600H / Z0402MF
Fluorescent tube lamp starter		
Electronic starter (18 to 70W)	Preheating + ignition of fluorescent tube lamps	EFS21-TL5
Ignitor		
Ignitor for HID lamp	High voltage pulses generator (with LIC01)	LIC01-195H / LIC01-215B / LIC01-215H
Ignitor for HID lamp (2)	High voltage pulses generator (with a triac)	Z0405MF / Z0409MF / T435-600B / T435-600H / T435-600T / DB3 / SMDB3
Camera flash		
	Ignition	P0111DA
Christmas lighting		
	Blinker pilot thyristor	XL0840
Compact fluorescent lighting High frequency ballast		
	Oscillator starter	DB3 / SMDB3

NEW PRODUCTS

Consumer - Office Equipment

APPLICATION	LOAD / FUNCTION	KEY PRODUCTS
Power supply (SMPS)		
Inrush current limiter	Inrush current limitation by shunting series resistor	TYN608 / TYN612 / TYN 616 / TYN 625 / BTW69-600 / BTB12-600BW / STIL02-P5 / STIL04-P5
TV-Monitor		
	Degaussing coil control	BTB06-600SW / BTB08-600SW / ACST6-7S / ACST8-8CFP
Photocopier Printer Fax		
	Heating resistor for toner	BTB08-600CW / BTB08-600SW / BTB16-600CW / BTB16-600SW / BTB24-600CW / BTB26-600B / BTB41-600B / BTA25-600B

NEW PRODUCT

Major Key Applications

HVAC - Heating, Ventilation, Air Conditioning

APPLICATION	LOAD / FUNCTION	KEY PRODUCTS
Air conditioner		
Compressor	ON / OFF control with triac (replacing a relay)	BTA41-600B
	ON / OFF control with a triac in parallel with a relay	BTA12-600B / BTA16-600B / BTA25-600B
Indoor fan (20 to 50W)	Induction motor Speed control	Z0107MA / Z0107MN / Z0109MA / Z0109MN / Z00607MA / Z04xxME / ACS110 / ACS120
Outdoor fan (Up to 50W and 50 to 100W)	Induction motor (Speed control by windings switching)	ACST4-7SFP / Z0405MF / Z0409MF / Z00607MA / T410-600W / T435-600W / Z0107MA / ACS110 / ACS120
Heating resistor (Up to 2kW)	Heater (Temperature control)	BTB16-600SW / T2550H-600T
Heating resistor (Below 50W)	Heater (Temperature control)	ACS108-5SA / Z01xxMA
Cooling / Heating mode	Valve (ON / OFF control)	ACS108-5SA / Z01xxMA / T410-600T / Z04xxMF
Deshumidifier		
Compressor	Induction motor (relay controlled by a Triac)	Z01xxMA / Z01xxMN / ACS108-5SA
Fan		
Ceiling fan	Induction motor Speed control	Z00607MA / Z045MF / Z0409MF / T410-600W / T435-600W / Z0107MA / ACS110 / ACS120
Desk fan	Induction motor Speed control	Z00607MA / Z045MF / Z0409MF / T410-600W / T435-600W / Z0107MA / ACS110 / ACS120
Room Heating Thermostat		
Heater	Resistive load Temperature control	BTB08-600CW / BTBT08-600SW / T1235H-600G / T1235H-600T / BTB16-600CW / BTB16-600SW / BTB24-600CW / BTB41-600B / BTA25-600B / T2550H-600T
Water Heater Electric Shower		
Heater	Resistor Temperature control	BTB16-600CW / BTB16-600SW / BTB24-600CW / BTB41-600B / BTA25-600B

NEW PRODUCT

Major Key Applications

Industrial

APPLICATION	LOAD / FUNCTION	KEY PRODUCTS
GFI (Ground fault interruptor)		
GFI	Electromechanical breaker control (with dedicated IC or with Discrete components)	X00602MA / X00605MA / P0111DA / P0102MA
Door opener		
	Induction motor ON-OFF / reversing	Z01xxMA / ACST4-7S / ACST6-7S / ACST8-8CFP / T830-800W
Solid state relays		
	Triacs or Thyristor are power AC switches driven by opto-insulated circuits	T835-600G / T1235-600G / BTAx-600BW / BTBxx-600BW / P0111MA / BTW69-1200 / MSS40-1500 / MSS50-1400
Programmable logic controller vending machine		
	Static switching	T835-600G / T1235-600G / ACST8-8CFP / ACST6-7 / CLT3-4BT6
Irrigation system		
	Valve control	Z01xxMA / ACS108-5SA / T4050-600B/H / BTB04-600SL
Welding equipment		
	Transformer control (phase angle)	BTA41-600B / BTB24-600BW / Z0109MA / DB3 / SMDB3
Battery charger		
	Transformer control (phase angle)	BTA41-600B / BTB24-600BW / Z0109MA / DB3 / SMDB3

NEW PRODUCT

Major Key Applications

Engine ignition and control

APPLICATION	LOAD / FUNCTION	KEY PRODUCTS
Engine ignition		
	Capacitive Discharge (Sparks generation)	X0405MF / TS420-600B / TS820-600B / X0205MA
Voltage regulation		
(For small engine with fly-wheel)	DC supply voltage regulation with 2 SCR's	TYN612T / TYN812T / TN805-600B / TS820-600T / TS1220-600B
Chain saw Lawn mover Leaf blower Trimmer Snow thrower		
	Capacitance discharge ignition circuit	TS420-600T / TYN612T / TYN812T / TN805-600B / TS820-600T / TS1220-600B

CROSS REFERENCE

XL1225 to MAC12D

INDUSTRY STANDARD	ST EQUIVALENT	ST NEAREST
XL1225	XL0840	
CT408	TYN612T	
FZE1658*	CLT3-4BT6*	
BCR10CM-12	BTB10-600CW	
BCR10CM-8	BTB10-600CW	
BCR10CS-12	T1235-600G	
BCR10CS-8	T1235-600G	
BCR10DM-12	BTA10-600CW	
BCR10DM-8	BTA10-600CW	
BCR10PM		T1020-600W
BCR10PM-14		ACST8-8CFP
BCR10UM-12	T1030-800W	
BCR10UM-8	BTA10-600CW	
BCR12CM-12	BTA10-600CW	
BCR12CM-8	BTB12-600CW	
BCR12CS-12	BTB12-600CW	
BCR12CS-8	T1235-600G	
BCR12DM-12	T1235-600G	
BCR12DM-8	BTB12-600CW	
BCR12PM-12	T1235-600G	
BCR12PM-14	BTB12-600CW	
BCR12UM-12	T1235-600G	
BCR12UM-8	BTB12-600CW	
BCR16CM-12	T1235-600G	
BCR16CM-8	BTB16-600CW	
BCR16CS-12	T1635-600G	
BCR16CS-8	T1635-600G	
BCR16DM-12	BTA16-600CW	
BCR16DM-8	BTA16-600CW	
BCR16PM-12	T1620-600W	
BCR16UM-12	BTA16-600SW	
BCR16UM-8	BTA16-600SW	
BCR1AM-12		ACS108-5SA
BCR1AM-8	Z0107MA	
BCR30AM-12		BTB41-600B
BCR30AM-8		BTB41-600B
BCR3AM-12		Z0410MF
BCR3AM-8		Z0410MF
BCR3AS12	T410-600B	
BCR3AS8	T410-600B	
BCR3KM-12	T410-600W	
BCR3KM-14	T410-700W	
BCR3KM-8	T410-600W	
BCR3PM-12	T435-600B	
BCR3PM-8	T435-600B	
BCR4AM-12	T410-600T	
BCR4AM-8	T410-600T	
BCR4PM-12	T410-600W	
BCR4PM-8	T410-600W	
BCR5A1S-12	T405-700H	
BCR5A1S-8	T405-700H	
BCR5AM-12	BTB06-600SW	
BCR5AM-8	BTB06-600SW	
BCR5AS-12	T410-600B	
BCR5AS-8	T410-600B	
BCR5DM-12	BTA06-600SW	
BCR5DM-8	BTA06-600SW	
BCR5PM-14	T435-800W	ACST6-7FP
BCR6AM-12	BTB06-600CW	
BCR6AM-8	BTB06-600CW	
BCR8CM-12	BTB08-600CW	
BCR8CM-8	BTB08-600CW	
BCR8CS-12	T1235-600G	
BCR8CS-8	T1235-600G	
BCR8DM-12	BTA08-600CW	
BCR8DM-8	BTA08-600CW	
BCR8PM-14L		ACST8-8CFP

INDUSTRY STANDARD	ST EQUIVALENT	ST NEAREST
BCR8PM-16L		ACST8-8CFP
BCR8UM-12	BTA08-600SW	
BCR8UM-8	BTA08-600SW	
2N5060	X00602MA	
2N5061	X00602MA	
2N5062	X00602MA	
2N5063	X00602MA	
2N5064	X00602MA	
2N6071	T435-600H	
2N6071A	T405-600H	
2N6071B		T405-600H
2N6073	T435-400H	
2N6073A	T405-600H	
2N6073B		T405-600H
2N6075	T435-600H	
2N6075A	T405-600H	
2N6075B		T405-600H
2N6342	BTB08-600BW	
2N6343	BTB08-600BW	
2N6344	BTB08-600BW	
2N6344A	BTB08-600B	
2N6345	BTB10-800BW	
2N6346	BTB08-600B	
2N6346A	BTB12-600B	
2N6347	BTB08-600B	
2N6347A	BTB12-600B	
2N6348	BTB08-600B	
2N6348A	BTB12-600B	
2N6349		BTB10-800B
2N6349A	BTB12-800B	
2N6394	TYN612	
2N6395	TYN612	
2N6396	TYN612	
2N6397	TYN612	
2N6398	TYN612	
2N6399	TYN812	
2N6400	TYN616	
2N6401	TYN616	
2N6402	TYN616	
2N6403	TYN616	
2N6404	TYN616	
2N6405	TYN816	
2N6504	TYN625	
2N6505	TYN625	
2N6506	TYN625	
2N6507	TYN625	
2N6508	TYN625	
2N6509	TYN825	
2N6564	X00602MA	
2N6565	X00602MA	
C106A		X0402MF
C106B		X0402MF
C106D		X0402MF
C106D1		X0402MF
C106F		X0402MF
C106M		X0402MF
C106M1		X0402MF
C122A1	TYN608	
C122B1	TYN608	
C122D1	TYN608	
C122F1	TYN608	
C122M1	TYN608	
C122N1	TYN808	
MAC08BT1	Z0109MN	
MAC08DT1	Z0109MN	
MAC08MT1	Z0109MN	
MAC12D	BTB12-600CW	

(*) Programmable logic controllers

CROSS REFERENCE

MAC12HCD to MAC229-6

INDUSTRY STANDARD	ST EQUIVALENT	ST NEAREST
MAC12HCD	BTB12-600BW	
MAC12HCM	BTB12-600BW	
MAC12HCN	BTB12-800BW	
MAC12M	BTB12-600CW	
MAC12N	BTB12-800CW	
MAC137-500	BTB08-600CW	
MAC137-600	BTB08-600CW	
MAC137-700	BTB08-800CW	
MAC137-800	BTB08-800CW	
MAC137G500	BTB08-600BW	
MAC137G600	BTB08-600BW	
MAC137G700	BTB08-800BW	
MAC137G800	BTB10-800BW	
MAC15-10	BTB16-800BW	
MAC15-10FP		BTA16-800BW
MAC15-4	BTB16-600BW	
MAC15-4FP		BTA16-600BW
MAC15-6	BTB16-600BW	
MAC15-6FP		BTA16-600BW
MAC15-8	BTB16-600BW	
MAC15-8FP		BTA16-600BW
MAC15A10	BTB16-800B	
MAC15A10FP		BTA16-800B
MAC15A4	BTB16-600B	
MAC15A4FP		BTA16-600B
MAC15A6	BTB16-600B	
MAC15A6FP		BTA16-600B
MAC15A8	BTB16-600B	
MAC15A8FP		BTA16-600B
MAC15D	BTB16-600CW	
MAC15M	BTB16-600CW	
MAC15N	BTB16-800CW	
MAC15SM		BTB16-600SW
MAC15SN		BTB16-800SW
MAC16-10	BTB16-800BW	
MAC16-4	BTB16-600BW	
MAC16-6	BTB16-600BW	
MAC16-8	BTB16-600BW	
MAC16CD	BTB16-600CW	
MAC16CM	BTB16-600CW	
MAC16CN	BTB16-800CW	
MAC16D	BTB16-600BW	
MAC16M	BTB16-600BW	
MAC16N	BTB16-800BW	
MAC210-10	BTB10-800BW	
MAC210-10FP		BTA10-800BW
MAC210-4	BTB10-600BW	
MAC210-4FP		BTA10-600BW
MAC210-6	BTB10-600BW	
MAC210-6FP		BTA10-600BW
MAC210-8	BTB10-600BW	
MAC210-8FP		BTA10-600BW
MAC210A10FP		BTA10-800B
MAC210A4	BTB10-600B	
MAC210A4FP		BTA10-600B
MAC210A6	BTB10-600B	
MAC210A6FP		BTA10-600B
MAC210A8	BTB10-600B	
MAC210A8FP		BTA10-600B
MAC212-10	BTB12-800BW	
MAC212-10FP		BTA12-800BW
MAC212-4	BTB12-600BW	
MAC212-4FP		BTA12-600BW
MAC212-6	BTB12-600BW	
MAC212-6FP		BTA12-600BW
MAC212-8	BTB12-600BW	
MAC212-8FP		BTA12-600BW

INDUSTRY STANDARD	ST EQUIVALENT	ST NEAREST
MAC212A10	BTB12-800B	BTA12-800B
MAC212A10FP		
MAC212A4	BTB12-600B	BTA12-600B
MAC212A4FP		
MAC212A6	BTB12-600B	BTA12-600B
MAC212A6FP		
MAC212A8	BTB12-600B	BTA12-600B
MAC212A8FP		
MAC218-10	BTB10-800BW	BTA12-600B
MAC218-10FP		BTA08-800BW
MAC218-4	BTB08-600BW	BTA08-600BW
MAC218-4FP		
MAC218-6	BTB08-600BW	BTA08-600BW
MAC218-6FP		
MAC218-8	BTB08-600BW	BTA08-600BW
MAC218-8FP		BTA08-600BW
MAC218A10		BTA10-800B
MAC218A10FP		BTA08-800C
MAC218A4	BTB08-600B	BTA08-600B
MAC218A4FP		
MAC218A6	BTB08-600B	BTA08-600B
MAC218A6FP		
MAC218A8	BTB08-600B	BTA08-600B
MAC218A8FP		
MAC223-10	BTB24-800BW	BTA08-600B
MAC223-10FP		BTA24-800BW
MAC223-4	BTB24-600BW	BTA24-600BW
MAC223-4FP		
MAC223-6	BTB24-600BW	BTA24-600BW
MAC223-6FP		
MAC223-8	BTB24-600BW	BTA24-600BW
MAC223-8FP		BTA24-600BW
MAC223A10		BTA24-800BW
MAC223A10FP		BTA24-800BW
MAC223A4		BTB24-600BW
MAC223A4FP		BTA24-600BW
MAC223A6		BTB24-600BW
MAC223A6FP		BTA24-600BW
MAC223A8		BTB24-600BW
MAC223A8FP		BTA24-600BW
MAC224-10		BTB41-800B
MAC224-4		BTB41-800B
MAC224-6		BTB41-600B
MAC224-8		BTB41-600B
MAC224A10		BTB41-800B
MAC224A4		BTB41-600B
MAC224A6		BTB41-600B
MAC224A8		BTB41-600B
MAC228-10	BTB08-800TW	BTA08-800TW
MAC228-10FP		
MAC228-4	BTB08-600TW	BTA08-600TW
MAC228-4FP		
MAC228-6	BTB08-600TW	BTA08-600TW
MAC228-6FP		
MAC228-8	BTB08-600TW	BTA08-600TW
MAC228-8FP		
MAC228A4		BTA08-600TW
MAC228A4FP		BTB08-600SW
MAC228A6		BTA08-600SW
MAC228A6FP		BTB08-600SW
MAC228A8		BTB08-600SW
MAC228A8FP		BTA08-600SW
MAC229-10	BTB08-800TW	BTA08-700TW
MAC229-10FP		
MAC229-4	BTB08-600SW	BTA08-600TW
MAC229-4FP		
MAC229-6	BTB08-600SW	BTA08-600TW

CROSS REFERENCE

MAC229-6FP to T2322D

INDUSTRY STANDARD	ST EQUIVALENT	ST NEAREST
MAC229-6FP	BTB08-600SW	BTA08-600TW
MAC229-8		BTA08-600TW
MAC229-8FP		BTB08-600SW
MAC229A4		BTA08-600SW
MAC229A4FP		BTB08-600SW
MAC229A6		BTA08-600SW
MAC229A6FP		BTB08-600SW
MAC229A8		BTA08-600SW
MAC229A8FP		BTB08-600SW
MAC310-4		BTA12-600SW
MAC310-6		BTA12-600SW
MAC310-8		BTA12-800SW
MAC310A4		BTB08-600SW
MAC310A6		BTB08-600SW
MAC320A10		BTB24-800BW
MAC320A4		BTB24-600BW
MAC320A6		BTB24-600BW
MAC320A8		BTB24-800BW
MAC321-10		BTB24-600CW
MAC321-4		BTB24-600CW
MAC321-6	BTB24-600CW	
MAC321-8	BTB24-600CW	
MAC4DCM	T435-600B	T435-700B
MAC4DCN		T435-700H
MAC4DCN-1	T405Q-600B	T405-600B
MAC4DHMT4		T405-700H
MAC4DHM-1	T405Q-600H	T405-600B
MAC4DLM		T405-700H
MAC4DLM-1	T410-600B	T405-700H
MAC4DSM		T410-800B
MAC4DSM-1	T405-700H	T410-800B
MAC4DSN		T410-800B
MAC4DSN-1	T435-600T	T405-700H
MAC4M		T435-800T
MAC4N	T410-600T	
MAC4SM	T410-800T	
MAC4SN	T410-800T	
MAC8D	BTB08-600CW	
MAC8M	BTB08-600CW	
MAC8N	BTB08-800CW	
MAC8SD	BTB08-600TW	
MAC8SM	BTB08-600TW	
MAC8SN	BTB08-800TW	
MAC97-4	Z00607MA	
MAC97-6	Z00607MA	
MAC97-8	Z00607MA	
MAC97A4	Z00607MA	
MAC97A6	Z00607MA	
MAC97A8	Z00607MA	
MAC97B4	Z0103MA	
MAC97B6	Z0103MA	
MAC97B8	Z0103MA	
MAC9D	BTB08-600BW	
MAC9M	BTB08-600BW	
MAC9N	BTB10-800BW	
MCR08BT1	P0102DN	
MCR08DT1	P0102DN	
MCR08MT1	X0202MN	
MCR100-3	X00602MA	
MCR100-4	X00602MA	
MCR100-6	X00602MA	
MCR100-8	X00602MA	
MCR102	X00602MA	
MCR103	X00602MA	
MCR106-2	X0402MF	
MCR106-3	X0402MF	
MCR106-4	X0402MF	

INDUSTRY STANDARD	ST EQUIVALENT	ST NEAREST
MCR106-6	X0402MF	
MCR106-8	X0402MF	
MCR12D	TYN612	
MCR12DCM	TN1215-600B	
MCR12DSM	TS1220-600B	
MCR12M	TYN612	
MCR12N	TYN812	
MCR16D	TYN616	
MCR16M	TYN616	
MCR16N	TYN816	
MCR218-10	TYN808	
MCR218-2	TYN608	
MCR218-3	TYN608	
MCR218-4	TYN608	
MCR218-6	TYN608	
MCR218-8	TYN608	
MCR22-2	X0202MA	
MCR22-3	X0202MA	
MCR22-4	X0202MA	
MCR22-6	X0202MA	
MCR22-8	X0202MA	
MCR25D	TYN625	
MCR25M	TYN625	
MCR25N	TYN825	
MCR264-10	TYN840	
MCR264-4	TYN640	
MCR264-6	TYN640	
MCR264-8	TYN640	
MCR265-10		BTW69-800
MCR265-2		BTW69-600
MCR265-4		BTW69-800
MCR265-6		BTW69-800
MCR265-8		TS820-600T
MCR310-4		TS820-600T
MCR310-6		TS820-700T
MCR310-8		TS820-600T
MCR506-2		TS820-600T
MCR506-3		TS820-600T
MCR506-4		TS820-600T
MCR506-6		TS820-600T
MCR506-8		TS820-600T
MCR68-2	TYN612	
MCR68-3	TYN612	
MCR68-4	TYN612	
MCR68-6	TYN612	
MCR69-2	TYN616	
MCR69-3	TYN616	
MCR69-4	TYN616	
MCR69-6	TYN616	
MCR703A		TS420-600B
MCR703A1		TS420-600T
MCR72-10		TS820-700T
MCR72-2	TS820-600T	
MCR72-3	TS820-600T	
MCR72-4	TS820-600T	
MCR72-6	TS820-600T	
MCR72-8	TS820-600T	
MCR8D	TYN608	
MCR8DCM	TN815-600B	
MCR8DCN	TN815-800B	
MCR8DSM	TS820-600B	
MCR8M	TYN608	
MCR8N	TYN808	
MCR8SD	TS820-600T	
MCR8SM	TS820-600T	
T2322B	T410-600H	
T2322D	T410-600H	

CROSS REFERENCE

T2322M to BT137B-600G

INDUSTRY STANDARD	ST EQUIVALENT	ST NEAREST
T2322M	T410-600H	
T2323B	T410-600H	
T2323D	T410-600H	
T2323M	T410-600H	
T2500B	BTB06-600C	
T2500BFP		BTA06-600C
T2500D	BTB06-600C	
T2500DFP		BTA06-600C
T2500M	BTB06-600C	
T2500MFP		BTA06-600C
T2800B	BTB08-600C	
T2800D	BTB08-600C	
T2800M	BTB08-600C	
2V5P4M	X0405MF	
BR100/03	DB3	
BT131-500	Z0103MA	
BT131-600	Z0103MA	
BT132-500D	Z0107MA	
BT132-600D	Z0107MA	
BT134-500		Z0410MF
BT134-500D		Z0405MF
BT134-500E		Z0409MF
BT134-500F		Z0410MF
BT134-500G		Z0410MF
BT134-600		Z0410MF
BT134-600D		Z0405MF
BT134-600E		Z0409MF
BT134-600F		Z0410MF
BT134-600G		Z0410MF
BT134-800		Z0410NF
BT134-800E		Z0409NF
BT134-800F		Z0410NF
BT134-800G		Z0410NF
BT134W-500	Z0110MN	
BT134W-500D	Z0107MN	
BT134W-500E	Z0109MN	
BT134W-500F	Z0110MN	
BT134W-500G	Z0110MN	
BT134W-600	Z0110MN	
BT134W-600D	Z0107MN	
BT134W-600E	Z0109MN	
BT134W-600F	Z0110MN	
BT134W-600G	Z0110MN	
BT136-500	T435-600T	
BT136-500D	T405-600T	
BT136-500E	T410-600T	
BT136-500F	T435-600T	
BT136-500G	T435-600T	
BT136-600	T435-600T	
BT136-600D	T435-600T	
BT136-600E	BTB04-600SL	
BT136-600F	T405-600T	
BT136-600G	T410-600T	
BT136-800	T435-600T	
BT136-800E	T435-800T	
BT136-800F	T410-800T	
BT136-800G	T410-800T	
BT136B-500	T435-800T	
BT136B-500D	T435-600B	
BT136B-500E	T405-600B	
BT136B-500F	T410-600B	
BT136B-500G	T410-600B	
BT136B-600	T435-600B	
BT136B-600D	T435-600B	
BT136B-600E	T405-600B	
BT136B-600F	T410-600B	
BT136B-600G	T410-600B	

INDUSTRY STANDARD	ST EQUIVALENT	ST NEAREST
BT136B-600G	T435-600B	
BT136B-800		T435-700B
BT136B-800E	T410-800B	
BT136B-800F	T410-800B	
BT136B-800G		T435-700B
BT136M-500	T435-600B	
BT136M-500D	T405-600B	
BT136M-500E	T410-600B	
BT136M-500F	T410-600B	
BT136M-500G	T435-600B	
BT136M-600	T435-600B	
BT136M-600D	T405-600B	
BT136M-600E	T410-600B	
BT136M-600F	T410-600B	
BT136M-600G	T435-600B	
BT136M-800		T435-700B
BT136M-800E	T410-800B	
BT136M-800F	T410-800B	
BT136M-800G		T435-700B
BT136S-500	T435-600B	
BT136S-500D	T405-600B	
BT136S-500E	T410-600B	
BT136S-500F	T410-600B	
BT136S-500G	T435-600B	
BT136S-600	T435-600B	
BT136S-600D	T405Q-600B	
BT136S-600E	T410-600B	
BT136S-600F	T410-600B	
BT136S-600G	T435-600B	
BT136S-800		T435-700B
BT136S-800G		T435-700B
BT136x-500	T435-600W	
BT136x-500D	T405-600W	
BT136x-500E	T410-600W	
BT136x-500F	T410-600W	
BT136x-500G	T435-600W	
BT136x-600	T435-600W	
BT136x-600D	T405-600W	
BT136x-600E	T410-600W	
BT136x-600F	T410-600W	
BT136x-600G	T435-600W	
BT136x-800	T435-600W	
BT136x-800E	T410-800W	
BT136x-800F	T410-800W	
BT136x-800G	T435-600W	
BT137-500	BTB08-600C	
BT137-500D		BTB08-600SW
BT137-500E		BTB08-600SW
BT137-500F	BTB08-600C	
BT137-500G	BTB08-600B	
BT137-600	BTB08-600C	
BT137-600D		BTB08-600SW
BT137-600E		BTB08-600SW
BT137-600F	BTB08-600C	
BT137-600G	BTB08-600B	
BT137-800	BTB08-800C	
BT137-800E		BTB08-800SW
BT137-800F	BTB08-800C	
BT137-800G		BTB10-800B
BT137B-500	T835-600G	
BT137B-500E		T835-600G
BT137B-500F		T835-600G
BT137B-500G	T835-600G	
BT137B-600	T835-600G	
BT137B-600E		T835-600G
BT137B-600F		T835-600G
BT137B-600G	T835-600G	

CROSS REFERENCE

BT137M-500 to BT139x-600G

INDUSTRY STANDARD	ST EQUIVALENT	ST NEAREST
BT137M-500		T835-600B
BT137M-500D		T810-600B
BT137M-500E		T810-600B
BT137M-500F		T810-600B
BT137M-500G		T835-600B
BT137M-600		T835-600B
BT137M-600D		T810-600B
BT137M-600E		T810-600B
BT137M-600F		T810-600B
BT137M-600G		T835-600B
BT137S-500	T835-600B	
BT137S-500D		T810-600B
BT137S-500E	T810-600B	
BT137S-500F	T810-600B	
BT137S-500G	T835-600B	
BT137S-600	T835-600B	
BT137S-600D		T810-600B
BT137S-600E	T810-600B	
BT137S-600F	T810-600B	
BT137S-600G	T835-600B	
BT137x-500		BTA08-600B
BT137x-500D		BTA08-600SW
BT137x-500E		BTA08-600SW
BT137x-500F		BTA08-600C
BT137x-500G		BTA08-600B
BT137x-600		BTA08-600B
BT137x-600D		BTA08-600SW
BT137x-600E		BTA08-600SW
BT137x-600F		BTA08-600C
BT137x-600G		BTA08-600B
BT137x-800		BTA08-800B
BT137x-800F		BTA08-800C
BT137x-800G		BTA08-800B
BT138-500	BTB12-600B	
BT138-500E		BTB12-600SW
BT138-500F	BTB12-600C	
BT138-500G	BTB12-600B	
BT138-600	BTB12-600B	
BT138-600E		BTB12-600SW
BT138-600F	BTB12-600C	
BT138-600G	BTB12-600B	
BT138-800	BTB12-800B	
BT138-800E		BTB12-800SW
BT138-800F		BTB12-800B
BT138-800G	BTB12-800B	
BT138B-500	T1235-600G	
BT138B-500E		T1235-600G
BT138B-500F		T1235-600G
BT138B-500G	T1235-600G	
BT138B-600	T1235-600G	
BT138B-600E		T1235-600G
BT138B-600F		T1235-600G
BT138B-600G	T1235-600G	
BT138F-500		BTA12-600BW
BT138F-500E		BTA12-600CW
BT138F-500F		BTA12-600CW
BT138F-500G		BTA12-600BW
BT138F-600		BTA12-600BW
BT138F-600E		BTA12-600CW
BT138F-600F		BTA12-600CW
BT138F-600G		BTA12-600BW
BT138F-700		BTA12-800BW
BT138F-700E		BTA12-800BW
BT138F-700F		BTA12-800CW
BT138F-700G		BTA12-800BW
BT138F-800		BTA12-800CW
BT138F-800E		BTA12-800CW

INDUSTRY STANDARD	ST EQUIVALENT	ST NEAREST
BT138F-800F		BTA12-800CW
BT138F-800G		BTA12-800BW
BT138x-500		BTA12-600B
BT138x-500E		BTA12-600C
BT138x-500F		BTA12-600C
BT138x-500G		BTA12-600B
BT138x-600		BTA12-600B
BT138x-600E		BTA12-600C
BT138x-600F		BTA12-600C
BT138x-600G		BTA12-600B
BT138x-800		BTA12-800B
BT138x-800E		BTA12-800B
BT138x-800F		BTA12-800B
BT138x-800G		BTA12-800B
BT139-500	BTB16-600B	
BT139-500E		BTB16-600SW
BT139-500F	BTB16-600C	
BT139-500G	BTB16-600B	
BT139-500H	BTB16-600B	
BT139-600	BTB16-600B	
BT139-600E		BTB16-600SW
BT139-600F	BTB16-600C	
BT139-600G	BTB16-600B	
BT139-600H		BTB16-600B
BT139-800	BTB16-800B	
BT139-800F	BTB16-800C	
BT139-800G	BTB16-800B	
BT139-800H		BTB16-800B
BT139B-500	T1635-600G	
BT139B-500E		T1635-600G
BT139B-500F		T1635-600G
BT139B-500G	T1635-600G	
BT139B-500H		T1635-600G
BT139B-600	T1635-600G	
BT139B-600E		T1635-600G
BT139B-600F		T1635-600G
BT139B-600G	T1635-600G	
BT139B-600H		T1635-600G
BT139F-500		T1635-600G
BT139F-500E		BTA16-600BW
BT139F-500F		BTA16-600SW
BT139F-500G		BTA16-600SW
BT139F-500H		BTA16-600BW
BT139F-600		BTA16-600BW
BT139F-600E		BTA16-600SW
BT139F-600F		BTA16-600SW
BT139F-600G		BTA16-600BW
BT139F-700		BTA16-600BW
BT139F-700E		BTA16-800SW
BT139F-700F		BTA16-800SW
BT139F-700G		BTA16-800CW
BT139F-700H		BTA16-800CW
BT139F-800		BTA16-800CW
BT139F-800E		BTA16-800CW
BT139F-800F		BTA16-800CW
BT139F-800G		BTA16-800BW
BT139F-800H		BTA16-800BW
BT139x-500		BTA16-600B
BT139x-500E		BTA16-600SW
BT139x-500F		BTA16-600C
BT139x-500G		BTA16-600B
BT139x-500H		BTA16-600B
BT139x-600		BTA16-600B
BT139x-600E		BTA16-600SW
BT139x-600F		BTA16-600C
BT139x-600G		BTA16-600B

CROSS REFERENCE

BT139x-600H to BTA204x-500E

INDUSTRY STANDARD	ST EQUIVALENT	ST NEAREST
BT139x-600H		BTA16-600B
BT139x-800		BTA16-800B
BT139x-800E		BTA16-800SW
BT139x-800F		BTA16-800CW
BT139x-800G		BTA16-800B
BT139x-800H		BTA16-800B
BT145-500R	TYN625	
BT145-600R	TYN625	
BT145-800R	TYN825	
BT148-400R		X0402MF
BT148-500R		X0402MF
BT148-600R		X0402MF
BT148MZ-600R		TS420-600B
BT148SZ-600R	TS420-600B	
BT148W-400	X0202MN	
BT148W-500	X0202MN	
BT148W-600	X0202MN	
BT149-B	X00602MA	
BT149-D	X00602MA	
BT149-E	X00602MA	
BT149-G	X00602MA	
BT150-500R	TS420-600T	
BT150-600R	TS420-600T	
BT150M-500R		TS420-600B
BT150M-600R		TS420-600B
BT150S-500R	TS420-600B	
BT150S-600R	TS420-600B	
BT151-500R	TYN612T	
BT151-650R	TYN812	
BT151-800R	TYN812	
BT151B-500R	TN1215-600G	
BT151B-600R	TN1215-600G	
BT151M-500R		TN1215-600B
BT151M-600R		TN1215-600B
BT151S-500R	TN1215-600B	
BT151S-600R	TN1215-600B	
BT152-400R	TYN625	
BT152-600R	TYN625	
BT152-800R	TYN825	
BT152B-400R	TN2540-600G	
BT152B-600R	TN2540-600G	
BT168B		X0202MA
BT168BW		X0202MN
BT168D		X0202MA
BT168DW		X0202MN
BT168E		X0202MA
BT168EW		X0202MN
BT168G		X0202MA
BT168GW		X0202MN
BT169B	X00602MA	
BT169-BW	P0102DN	
BT169D	X00602MA	
BT169DW	P0102DN	
BT169E	X00602MA	
BT169-EW	X0202MN	
BT169G	X00602MA	
BT169-GW	X0202MN	
BT258-500R	TS820-600T	
BT258-600R	TS820-600T	
BT258B-500R		TS820-600B
BT258B-600R		TS820-600B
BT258M-500R		TS820-600B
BT258M-600R		TS820-600B
BT258S-500R	TS820-600B	
BT258S-600R	TS820-600B	
BT258S-800R	TS820-800B	
BT300-500R	TYN608	

INDUSTRY STANDARD	ST EQUIVALENT	ST NEAREST
BT300-600R	TYN608	
BT300-800R	TYN808	
BT300B-500R	TN815-600B	TN815-600B
BT300B-600R	TN815-600B	TN815-600B
BT300M-500R		
BT300M-600R		
BT300S-500R	TN815-600B	
BT300S-600R	TN815-600B	
BTA140-500	BTB24-600CW	
BTA140-600	BTB24-600CW	
BTA140B-500	T2535-600G	
BTA140B-600	T2535-600G	
BTA151-500R		TYN612T
BTA151-650R		TYN812T
BTA151-800R		TYN812T
BTA204-500B	T435-600T	
BTA204-500C	T435-600T	
BTA204-500D	T405-600T	
BTA204-500E	T410-600T	
BTA204-500F	T410-600T	
BTA204-600B	T435-600T	
BTA204-600C	T435-600T	
BTA204-600D	T405-600T	
BTA204-600E	T410-600T	
BTA204-600F	T410-600T	
BTA204-800B	T435-800T	
BTA204-800C	T435-800T	
BTA204-800E	T410-800T	
BTA204-800F	T410-800T	
BTA204M-500B		T435-600B
BTA204M-500C		T435-600B
BTA204M-500D		T405-600B
BTA204M-500E		T410-600B
BTA204M-500F		T435-600B
BTA204M-600B		T435-600B
BTA204M-600C		T435-600B
BTA204M-600D		T405-600B
BTA204M-600E		T410-600B
BTA204M-600F		T435-600B
BTA204M-800B		T435-700B
BTA204M-800C		T435-700B
BTA204M-800E		T410-800B
BTA204M-800F		T435-700B
BTA204S-500B	T435-600B	
BTA204S-500C	T435-600B	
BTA204S-500D	T405-600B	
BTA204S-500E	T410-600B	
BTA204S-500F	T435-600B	
BTA204S-600B	T435-600B	
BTA204S-600C	T435-600B	
BTA204S-600D	T405-600B	
BTA204S-600E	T410-600B	
BTA204S-600F	T435-600B	
BTA204W-500B		Z0110MN
BTA204W-500C		Z0110MN
BTA204W-500D	Z0107MN	
BTA204W-500E	Z0109MN	
BTA204W-500F	Z0110MN	
BTA204W-600B		Z0110MN
BTA204W-600C		Z0110MN
BTA204W-600D	Z0107MN	
BTA204W-600E	Z0109MN	
BTA204W-600F	Z0110MN	
BTA204x-500B	T435-600W	
BTA204x-500C	T405-600W	
BTA204x-500D	T410-600W	
BTA204x-500E	T410-600W	

CROSS REFERENCE

BTA204x-500F to T106B1

INDUSTRY STANDARD	ST EQUIVALENT	ST NEAREST
BTA204x-500F	T410-600W	
BTA204x-600B	T435-600W	
BTA204x-600C	T435-600W	
BTA204x-600D	T405-600W	
BTA204x-600E	T410-600W	
BTA204x-600F	T410-600W	
BTA204x-800B	T435-800W	
BTA204x-800C	T435-800W	
BTA204x-800E	T410-800W	
BTA204x-800F	T410-800W	
BTA208-500B	BTB08-600BW	
BTA208-500C	BTB08-600CW	
BTA208-500D	BTB08-600TW	
BTA208-500E	BTB08-600SW	
BTA208-500F	BTB08-600SW	
BTA208-600B	BTB08-600BW	
BTA208-600C	BTB08-600CW	
BTA208-600D	BTB08-600TW	
BTA208-600E	BTB08-600SW	
BTA208-600F	BTB08-600SW	
BTA208-800B	BTB08-800BW	
BTA208-800C	BTB08-800CW	
BTA208-800E	BTB08-800SW	
BTA208-800F	BTB08-800SW	
BTA208B-500C	T835-600G	
BTA208B-500E	T835-600G	
BTA208B-500F	T835-600G	
BTA208B-600C	T835-600G	
BTA208B-600E	T835-600G	
BTA208B-600F	T835-600G	
BTA208M-500B	T835-600B	
BTA208M-500C	T810-600B	
BTA208M-500D	T810-600B	
BTA208M-500E	T810-600B	
BTA208M-500F	T810-600B	
BTA208M-600B	T835-600B	
BTA208M-600C	T835-600B	
BTA208M-600D	T810-600B	
BTA208M-600E	T810-600B	
BTA208M-600F	T810-600B	
BTA208S-500B	T835-600B	
BTA208S-500C	T835-600B	
BTA208S-500D	T810-600B	
BTA208S-500E	T810-600B	
BTA208S-500F	T810-600B	
BTA208S-600B	T835-600B	
BTA208S-600C	T835-600B	
BTA208S-600D	T810-600B	
BTA208S-600E	T810-600B	
BTA208S-600F	T810-600B	
BTA208x-500B	BTB12-600BW	
BTA208x-500C	BTB12-600CW	
BTA208x-500D	BTB12-600SW	
BTA208x-500E	BTB12-600SW	
BTA208x-500F	BTB12-600SW	
BTA208x-600B	BTB12-600BW	
BTA208x-600C	BTB12-600CW	
BTA208x-600D	BTB12-600SW	
BTA208x-600E	BTB12-600SW	
BTA208x-600F	BTB12-600SW	
BTA208x-800B	BTB12-600BW	
BTA208x-800C	BTB12-600CW	
BTA208x-800E	BTB12-600SW	
BTA208x-800F	BTB12-600SW	
BTA212-500B	BTB12-600BW	
BTA212-500C	BTB12-600CW	
BTA212-500D	BTB12-600SW	

INDUSTRY STANDARD	ST EQUIVALENT	ST NEAREST
BTA212-500E	BTB12-600SW	
BTA212-500F	BTB12-600SW	
BTA212-600B	BTB12-600BW	
BTA212-600C	BTB12-600CW	
BTA212-600D	BTB12-600SW	BTB12-600SW
BTA212-600E	BTB12-600SW	
BTA212-600F	BTB12-600SW	
BTA212-800B	BTB12-800BW	
BTA212-800C	BTB12-800CW	
BTA212B-500B	T1235-600G	
BTA212B-500C	T1235-600G	
BTA212B-500D	T1235-600G	
BTA212B-500E	T1235-600G	
BTA212B-500F	T1235-600G	
BTA212B-600B	T1235-600G	
BTA212B-600C	T1235-600G	
BTA212B-600D	T1235-600G	
BTA212B-600E	T1235-600G	
BTA212B-600F	T1235-600G	
BTA212x-500B	BTB16-600BW	
BTA212x-500C	BTB16-600CW	
BTA212x-500D	BTB16-600SW	
BTA212x-500E	BTB16-600SW	
BTA212x-500F	BTB16-600SW	
BTA212x-600B	BTB16-600BW	
BTA212x-600C	BTB16-600CW	
BTA212x-600D	BTB16-600SW	
BTA212x-600E	BTB16-600SW	
BTA212x-600F	BTB16-600SW	
BTA212x-800B	BTB16-800BW	
BTA212x-800C	BTB16-800CW	
BTA216-500B	T1635-600G	
BTA216-500C	T1635-600G	
BTA216-500E	T1635-600G	
BTA216-500F	T1635-600G	
BTA216-600B	BTB24-600BW	
BTA216-600C	BTB24-600CW	
BTA216-600E	BTB24-600SW	
BTA216-600F	BTB24-600SW	
BTA216x-800B	BTB24-800BW	
BTA216x-800C	BTB24-800CW	
BTA216x-800E	BTB24-800SW	
BTA216x-800F	BTB24-800SW	
BTA225-500B	T2535-600G	
BTA225-500C	T2535-600G	
BTA225-600B	T2535-600G	
BTA225-600C	T2535-600G	
BTA225-800B	X0402MF	
BTA225-800C	X0402MF	
BTA225B-500B	X0402MF	
BTA225B-500C	X0402MF	
BTA225B-600B	X0402MF	
BTA225B-600C	X0402MF	
T106A1		
T106B1		

CROSS REFERENCE

T106C1 to Q2008F41

INDUSTRY STANDARD	ST EQUIVALENT	ST NEAREST
T106C1	X0402MF	
T106D1	X0402MF	
T106E1	X0402MF	
T106F1	X0402MF	
T106M1	X0402MF	
T107A1	X0402MF	
T107B1	X0402MF	
T107C1	X0402MF	
T107D1	X0402MF	
T107E1	X0402MF	
T107F1	X0402MF	
T107M1	X0402MF	
TIC225D	BTB08-600SW	
TIC225M	BTB08-600SW	
TIC225N	BTB08-800SW	
TIC225S	BTB08-800SW	
MCR100-6	XL0840	
EC103A	X00602MA	
EC103A1		P0111DA
EC103A2	P0115DA	
EC103A3	X00602MA	
EC103B	X0205MA	
EC103B1		P0111DA
EC103B2	P0115DA	
EC103B3	X00602MA	
EC103C	X00602MA	
EC103C1		P0111DA
EC103C2	P0115DA	
EC103C3	X00602MA	
EC103D	X00602MA	
EC103D1		P0111DA
EC103D2	P0115DA	
EC103D3	X00602MA	
EC103E	X00602MA	
EC103E2		P0111MA
EC103E3	X00602MA	
EC103M	X00602MA	
EC103M1		P0111DA
EC103M2		P0111MA
EC103M3	X00602MA	
EC113A	X00602MA	
EC113A3	X00602MA	
EC113B	X00602MA	
EC113B3	X00602MA	
EC113C	X00602MA	
EC113C3	X00602MA	
EC113D	X00602MA	
EC113D3	X00602MA	
EC113E	X00602MA	
EC113E3	X00602MA	
EC113M	X00602MA	
EC113M3	X00602MA	
HT-32	DB3	
HT-32A		DB3
HT-32B		DB3
HT-34B		DB3
HT-35		DB3
HT-36A		DB3
HT-36B		DB3
HT-5761		DB3
HT-5761A		DB3
HT-5762		DB3TG
K2400E70		LIC01-215H
K2400F1		LIC01-215H
K2400S		LIC01-215B
K2401F1		LIC01-215H
L2004F32	Z0402MF	

INDUSTRY STANDARD	ST EQUIVALENT	ST NEAREST
L2004F51	T410-600D	
L2004F52	Z0405MF	
L2004F61	Z0409ME	
L2004F62	Z0405MF	
L2004F81	TS420-600T	BTB04-600A
L2004F82	Z0409MF	
L2004L5	L2004L6	
L2004L6	L2004L6	
L2006L5	L2006L5	
L2006L6	L2006L6	
L2006L8	L2006L8	
L2008L6	L2008L6	
L2008L8	L2008L8	
L201E3	L201E3	
L201E5	L201E5	
L201E6	L201E6	
L201E8	L201E8	
L4004D5	L4004D5	
L4004D6	L4004D6	
L4004F32	L4004F32	
L4004F51	L4004F51	
L4004F52	L4004F52	
L4004F61	L4004F61	
L4004F62	L4004F62	
L4004F81	L4004F81	
L4004F82	L4004F82	
L4004L3	L4004L3	
L4004L5	L4004L5	
L4004L6	L4004L6	
L4006L5	L4006L5	
L4006L6	L4006L6	
L4006L8	L4006L8	
L4008L6	L4008L6	
L4008L8	L4008L8	
L401E3	L401E3	
L401E5	L401E5	
L401E6	L401E6	
L401E8	L401E8	
L6004D5	L6004D5	
L6004D6	L6004D6	
L6004F32	L6004F32	
L6004F51	L6004F51	
L6004F52	L6004F52	
L6004F61	L6004F61	
L6004F62	L6004F62	
L6004F81	L6004F81	
L6004F82	L6004F82	
L6004L3	L6004L3	
L6004L5	L6004L5	
L6004L6	L6004L6	
L6006L5	L6006L5	
L6006L6	L6006L6	
L6006L8	L6006L8	
L6008L6	L6008L6	
L6008L8	L6008L8	
L601E3	L601E3	
L601E5	L601E5	
L601E6	L601E6	
L601E8	L601E8	
Q2004L3	Q2004L3	
Q2006L4	Q2006L4	
Q2006LH4	Q2006LH4	
Q2006R4	Q2006R4	
Q2006RH4	Q2006RH4	
Q2008F41	Q2008F41	
	T410-600D	
	Z0405MF	
	Z0409ME	
	Z0405MF	
	TS420-600T	BTB04-600A
	Z0409MF	
	BTA04-600T	
	BTA04-600D	
		BTB06-600T
		BTB06-600S
	BTA06-600SW	
	BTA08-600TW	
	BTA08-600SW	
		Z0103MA
		Z0107MA
		Z0107MA
	Z0109MA	
	T405-600B	
	T410-600B	
	Z0402MF	
	Z0405MF	
	Z0405MF	
	Z0409DE	
	Z0405MF	
	Z0410ME	
	Z0409MF	
		BTA06-600TW
	T405-600T	
	BTA04-600S	
		BTA06-600TW
	BTA06-600TW	
	BTA06-600SW	
	BTA08-600T	
	BTA08-600SW	
		Z0103MA
		Z0107MA
	Z0109DA	
	Z0110MA	
	T405-600B	
	T410-600B	
	Z0402MF	
	Z0405ME	
	Z0405MF	
	Z0409MF	
	Z0409MF	
		BTB04-600S
	Z0409MF	
		Z0302MF
	T405-600T	
	T410-600T	
	BTA06-600TW	
	BTA06-600TW	
	BTA08-600TW	
	BTA08-600TW	
	BTA08-600SW	
		Z0103MA
	Z0107MA	
		Z0107MA
	Z0109MA	
		Z0107MA
	Z0110MA	
	BTA06-600SW	
	BTA06-600C	
	BTA06-600CW	
	BTB06-600B	
	BTB06-600CW	
		BTB08-600CW

CROSS REFERENCE

Q2008L4 to Q7008LH4

INDUSTRY STANDARD	ST EQUIVALENT	ST NEAREST
Q2008L4	BTA08-600CW	BTA08-600C
Q2008LH4	BTB08-600C	
Q2008R4	BTB08-600CW	
Q2008RH4	BTA10-600BW	
Q2010L5	BTA10-600BW	
Q2010LH5	BTB10-600B	
Q2010R5	BTB10-600BW	
Q2010RH5	BTA12-600BW	
Q2012LH5	BTB12-600BW	
Q2012RH5	BTA16-600BW	
Q2015L5	BTA16-600BW	
Q2015L6		
Q2015LS		BTA16-600AW
Q2015R5		BTB16-600B
Q2015R6	BTB16-600BW	
Q201E3		Z0109MA
Q201E4		Z0110MA
Q2025J6		BTA26-600BW
Q2025K6	BTA26-600BW	
Q2025L5	BTB24-600BW	
Q2025L6	BTA24-600BW	
Q2025P		BTA25-600B
Q2025R6	BTB24-600BW	
Q2040K7		BTB41-600B
Q2040P		BTA40-600B
Q2x8E3	Z0109MA	
Q2x8E4	Z0110MA	
Q4004L3	BTA06-600SW	
Q4004L4		BTA06-600CW
Q4006H4		BTB06-600C
Q4006L4	BTA06-600C	
Q4006LH4	BTA06-600CW	
Q4006R4	BTB06-600C	
Q4006RH4	BTB06-600CW	
Q4008H4		BTB08-600C
Q4008L4		BTA08-600C
Q4008LH4	BTA08-600CW	
Q4008R4		BTB08-600C
Q4008RH4	BTB08-600CW	
Q4010L5	BTA10-600BW	
Q4010LH5	BTA10-600BW	
Q4010R5	BTB10-600BW	
Q4010RH5	BTB10-600BW	
Q4012LH5	BTA12-600BW	
Q4012RH5	BTB12-600BW	
Q4015L5		BTA16-600B
Q4015L6	BTA16-600BW	
Q4015LS		BTA16-600AW
Q4015R5		BTB16-600B
Q4015R6	BTB16-600BW	
Q401E3		Z0109MA
Q401E4		Z0110MA
Q4025J6		BTA26-600BW
Q4025K6	BTA26-600BW	
Q4025L5	BTB24-600BW	
Q4025L6	BTA24-600B	
Q4025P		BTA25-600B
Q4025R5		BTB19-600B
Q4025R6	BTB24-600BW	BTB24-600B
Q4040K7		BTA41-600B
Q4040P		BTA40-600B
Q5004L3	BTA06-600SW	
Q5004L4		BTA06-600CW
Q5006L4		BTA06-600CW
Q5006LH4	BTA06-600CW	
Q5006R4		BTB06-600CW

INDUSTRY STANDARD	ST EQUIVALENT	ST NEAREST
Q5006RH4	BTB06-600CW	
Q5008L4		BTA08-600CW
Q5008LH4	BTA08-600CW	
Q5008R4	BTB08-600C	
Q5008RH4	BTB08-600CW	
Q5010L5	BTA10-600B	
Q5010LH5	BTA10-600BW	
Q5010R5	BTB10-600B	
Q5010RH5	BTB10-600BW	
Q5012LH5	BTA12-600BW	
Q5012RH5	BTB12-600BW	
Q5015L5	BTA16-600B	
Q5015L6		
Q5015R5		BTB15-600B
Q5015R6	BTB16-600BW	
Q501E3		Z0109MA
Q501E4		Z0110MA
Q5025J6		BTA26-600BW
Q5025K6	BTA26-600BW	
Q5025L5	BTB24-600BW	
Q5025L6	BTA24-600BW	
Q5025P		BTA25-600BW
Q5025R6	BTB24-600BW	
Q5040P		BTW41-500G
Q6004L3	BTA06-600SW	
Q6004L4		BTA06-600CW
Q6006L5	BTA06-600BW	
Q6006LH4	BTA06-600CW	
Q6006R5	BTB06-600B	
Q6006RH4	BTB06-600CW	
Q6008L5	BTA08-600B	
Q6008LH4	BTA08-600CW	
Q6008R5	BTB08-600BW	
Q6008RH4	BTB08-600CW	
Q6010L5	BTA10-600B	
Q6010LH5	BTA10-600BW	
Q6010R5	BTB10-600BW	
Q6010RH5	BTB10-600BW	
Q6012LH5	BTA12-600BW	
Q6012RH5	BTB12-600BW	
Q6015L5	BTB16-600BW	
Q6015L6		
Q6015R5		BTB16-600B
Q6015R6	BTB16-600BW	
Q601E3		Z0109MA
Q601E4		Z0110MA
Q6025J6		BTA26-600BW
Q6025K6	BTA26-600BW	
Q6025L5	BTB24-600BW	
Q6025L6	BTA24-600BW	
Q6025P		BTA25-600BW
Q6025R5		BTB24-600C
Q6025R6	BTB24-600BW	
Q6025R6	BTB25-600BW	
Q6025P		BTA25-600B
Q6040K7		BTA41-600B
Q6040P		BTA40-600B
Q6x8E3	Z0109MA	
Q6x8E4	Z0110MA	
Q7004L4		BTA06-800CW
Q7006L5	BTA06-700B	
Q7006LH4	BTA06-700CW	
Q7006R5	BTB06-800BW	
Q7006RH4		BTB06-800BW
Q7008L5	BTA08-800B	
Q7008L5		BTA08-700C
Q7008LH4	BTA08-700CW	

CROSS REFERENCE

Q7008R5 to S6035K

INDUSTRY STANDARD	ST EQUIVALENT	ST NEAREST
Q7008R5	BTB08-800BW	
Q7008RH4	BTB08-800CW	
Q7010L5		BTA10-700AW
Q7010L5		BTA10-700C
Q7010LH5		BTA10-700CW
Q7010RH5	BTB10-800BW	
Q7010RH5		BTB10-700CW
Q7012LH5	BTA12-700BW	
Q7012RH5	BTB12-600BW	
Q7015L5	BTB16-800BW	
Q7015L6		BTA16-700BW
Q7015R5		BTB16-700C
Q7015R6	BTB16-800BW	
Q7025J6		BTA26-800BW
Q7025K6	BTA26-800BW	
Q7025L5	BTB24-800BW	
Q7025L6	BTA20-700BW	
Q7025P		BTA25-800BW
Q7025R5		BTB24-700B
Q7025R6	BTB20-700BW	
Q7040K7		BTA41-700B
Q7040P		BTA40-700B
Q8004F41		T435-800T
Q8004L4		BTA06-800CW
Q8006L5		BTA06-800BW
Q8006LH4	BTA06-800CW	
Q8006R5	BTB06-800BW	
Q8006RH4	BTB06-800CW	
Q8008L5	BTA08-800BW	
Q8008LH4	BTA08-800CW	
Q8008R5	BTB08-800B	
Q8008RH4	BTB08-800BW	
Q8010L5	BTA10-800BW	
Q8010LH5	BTA10-800BW	
Q8010R5	BTB10-800BW	
Q8010RH5	BTB10-800BW	
Q8010RHS		BTB10-800BW
Q8012LH5	BTA12-800BW	
Q8012RH5	BTB12-800BW	
Q8015L5		BTA16-800B
Q8015L6	BTA16-800BW	
Q8015R5		BTB16-800BW
Q8015R6	BTB16-800BW	
Q8025J6		BTA26-800BW
Q8025K6	BTA26-800BW	
Q8025L5	BTB24-800BW	
Q8025L6	BTA24-800BW	
Q8025P		BTA25-800BW
Q8025R5		BTB24-800B
Q8025R6	BTB24-800BW	
Q8040K7		BTA41-800B
S0506F1	TS820-600T	
S0506LS2		TXN406
S0506LS3		TXN406
S0508LS2		TXN608
S0508LS3		TXN608
S0508R	TYN608	
S0510R	TYN612	
S0512R	TYN612	
S0516R	TYN616	
S051E		X0202MA
S0525R	TYN625	
S0535K		BTW69-600
S0555M	BTW69-600	
S0555W		BTW69-600
S1006F1	TS820-600T	
S1006LS2		TXN406

INDUSTRY STANDARD	ST EQUIVALENT	ST NEAREST
S1006LS3		TXN406
S1008LS2		TXN608
S1008LS3		TXN608
S1008R	TYN608	
S1010R	TYN612	
S1012R	TYN612	
S1016R	TYN616	
S101E		X0202MA
S1025R		BTW69-600
S1035K	TYN625	
S1055M		BTW69-600
S1055W	BTW69-600	
S2006F1		BTW69-600
S2006LS2	TS820-600T	
S2006LS3		TXN406
S2008LS2		TXN406
S2008LS3		TXN608
S2008R	TYN608	
S2010R	TYN612	
S2012R	TYN612	
S2016R	TYN616	
S201E		X0202MA
S2025R	TYN625	
S2035J		BTW68-600
S2035K	BTW68-600	
S2055M		BTW69-600
S2055W		BTW69-600
S2065J		BTW67-600
S2065K	BTW69-600	
S2070W		BTW70-600N
S2800A	TYN612	
S2800B	TYN612	
S2800D	TYN612	
S2800F	TYN612	
S2800M	TYN612	
S2800N	TYN812	
S4006F1		TS820-600T
S4006LS2	TYN612	
S4006LS3	TYN612	
S4008LS2	TYN612	
S4008LS3	TYN612	
S4008R	TYN408	
S4010R	TYN410	
S4012R	TYN612	
S4016R	TYN616	
S401E		X0202MA
S4025R	TYN625	
S4035J		BTW66-600
S4035K	BTW68-600	
S4055M	BTW69-800	
S4055W		BTW69-800
S4065J		BTW67-600
S4065K	BTW69-600	
S4070W	BTW69-600	
S6006F1		TYN606
S6006LS2		TS820-600T
S6006LS3		TS820-600T
S6008LS2		TS820-600T
S6008LS3		TS820-600T
S6008R	TYN608	
S6010R	TYN612	
S6012R	TYN612	
S6016R	TYN616	
S601E		X0202MA
S6025R	TYN625	
S6035J	BTW68-601	
S6035K	BTW68-600	

CROSS REFERENCE

S6055M to AC10DGM

INDUSTRY STANDARD	ST EQUIVALENT	ST NEAREST
S6055M	BTW69-800	BTW69-800
S6055W		BTW67-600
S6065J		
S6065K	BTW69-600	
S6370	X00602MA	
S6744		TYN612
S6785G		TYN608
S8008R	TYN808	
S8010R	TYN812	
S8012R	TYN812	
S8016R	TYN816	
S8025R	TYN825	
S8035J	BTW69-800	
S8035K	BTW68-800	
S8055M	BTW69-800	
S8055W		BTW69-800
S8065J		BTW67-800
S8065K	BTW69-800	
T106A1	X0402MF	TYS406-1
T106B1	X0402MF	X0403BE
T106B2	X0402MF	
T106D1	X0402MF	
T106D2	X0405ME	
T106F1	TS420-600T	
T106M1	X0402ME	
T106M2	X0402MF	
TCR22-2	X0202MA	
TCR22-3	X0202MA	
TCR22-4	X0202MA	
TCR22-6	X0202DA	
TCR22-8	X0202MA	
SM12JZ47	T1230-600W	
SM12JZ47A	T1220-600W	
SM12LZ47		T1030-800W
SM12LZ47A	T1020-800W	
SM16JZ47	T1630-600W	
SM16JZ47A	T1620-600W	
SM1L43		ACS108-5SA
SM2LZ47		ACS110-7SB2
SM5LZ47	T630-800W	ACST6-7FP
SM6JZ47	T630-600W	
SM6JZ47A	T620-600W	
SM8JZ47A	T820-600W	
SM8JZ47	T830-600W	
SM8LZ47	T830-800W	ACST8-8CFP
USF05G49	P0102DN	
USF10G48		TN1625-600G
USF10J48		TN1625-600G
USF3G48		TS420-600B
USF3J48		TS420-600B
USF5G48		TN805-600B
USF5J48		TN805-600B
USF8G48	TN1215-600G	
USF8J48	TN1215-600G	
USM12G48	T1235-600G	T1235-600G
USM12G48A		
USM12J48		T1235-600G
USM12J48A		
USM16G48	T1635-600G	
USM16G48A		T1635-600G
USM16J48	T1635-600G	
USM16J48A		T1635-600G
USM3G48		T410-600B
USM3J48		T410-600B
USM6G48	T835-600G	
USM6G48A		T835-600G
USM6J48	T835-600G	

INDUSTRY STANDARD	ST EQUIVALENT	ST NEAREST
USM6J48A		T835-600G
USM8G48	T835-600G	
USM8G48A		T835-600G
USM8J48	T835-600G	
USM8J48A		T835-600G
XL1225-AB	XL0840	
XL1225-AD	XL0840	
YCR02	X0202MA	
YCR08	TYN612	
03P2M	X00602MA	
03P4M	X00602MA	
03P4MF	P0111DA	
03P4MG	P0111DA	
03P6MG	X0205MA	
03P6MG	X0205MA	
2P4M	X0402MF	
2P4M	X0402MF	
2P5M	X0402MF	
2P5M	X0402MF	
2P6M	X0402MF	
2P6M	X0402MF	
2S2M	X0402MF	
2S4M	X0402MF	
2S4M	X0402MF	
2V5P4M	X0405MF	
3P4J-Z	TS420-600B	
3P4MH		X0402MF
3P4MH		X0402MF
3P5MH		X0402MF
3P5MH		X0402MF
3P6MH		X0402MF
3P6MH		X0402MF
5P4J-Z	TS820-600B	
5P4M	TYN608	
5P5M	TYN608	
5P6J-Z	TS820-600B	
5P6M	TYN608	
8P2M	TYN412	
8P4J-Z	TN1215-600B	
8P4M	TYN612	
AC01DGM	Z0103MA	
AC01DGM	Z0103MA	
AC01DGM	Z0103MA	
AC01DJM	Z0107MN	
AC03DGM	Z0409MF	
AC03DGM	Z0409MF	
AC03DJM	T405-700H	
AC03DJM-Z	T410-600B	
AC03DSM	T410-600W	
AC03DSMA	T410-600W	
AC03FGM	Z0409MF	
AC03FGM	Z0409MF	
AC03FJM	T405-700H	
AC03FJM-Z	T410-600B	
AC03FSM	T410-600W	
AC03FSMA	T410-600W	
AC05DGM	BTB06-600SW	
AC05EGM	BTB06-600SW	
AC05FGM	BTB06-600SW	
AC08DGM	BTB08-600SW	
AC08EGM	BTB08-600SW	
AC08FGM	BTB08-600SW	
AC08FSM	T820-600W	
AC0V8DGM	Z00607MA	
AC0V8DGM	Z00607MA	
AC0V8DGM	Z00607MA	
AC10DGM		BTB10-600CW

CROSS REFERENCE

AC10EGM to URSF05G49-5P

INDUSTRY STANDARD	ST EQUIVALENT	ST NEAREST
AC10EGM		BTB10-600CW
AC10FGM		BTB10-600CW
AC12DGM	BTB12-600SW	
AC12EGM	BTB12-600SW	
AC12FGM	BTB12-600SW	
AC16DGM	BTB16-600CW	
AC16EGM	BTB16-600CW	
AC16FGM	BTB16-600CW	
CR02AM-4		P0111DA
CR02AM-6		P0111DA
CR02AM-8		P0111DA
CR02AM-8A		P0111DA
CR03AM-12		X00602MA
CR03AM-8		X00602MA
CR04AM12		X00602MA
CR04AM8		X00602MA
CR05AS-4		X0205MN
CR05AS-8		X0205MN
CR08AS-12		X0205MN
CR08AS-8		X0205MN
CR12AM-12	TYN625	
CR12AM-8	TYN625	
CR2AM-12	X0405MF	
CR2AM-8	X0405MF	
CR3AM-12		X0402MF
CR3AM-8		X0402MF
CR3AS-12	TS420-600B	
CR3AS-8	TS420-600B	
CR3CM-12		X0402MF
CR3CM-8		X0402MF
CR5A1S-12		TS820-600T
CR5A1S-8		TS820-600T
CR5AS-12	TS820-600B	
CR5AS-8	TS820-600B	
CR6AM-8	TYN610	
CR6CM-12	TYN610	
CR6CM-8	TYN610	
CR8AM-12	TYN612	
CR8AM-8	TYN612	
CR8CM-12	TYN612	
CR8CM-8	TYN612	
RSF05G1-1P	X00602MA	
RSF05G1-3P	X00602MA	
RSF05G1-5P	X00602MA	
SF0R3G42	X00602MA	
SF0R5G43	X00602MA	
SF0R5J43	X00602MA	
SF10G41A	TYN616	
SF10G48		TYN616
SF10GZ47		TYN616
SF10J41A	TYN616	
SF10J48		TYN616
SF10JZ47		TYN616
SF16GZ51		BTW69-600
SF16JZ51		BTW69-600
SF25GZ51		BTW69-600
SF25JZ51		BTW69-600
SF3G48		TYN608
SF3GZ47		TYN608
SF3J48		TYN608
SF3JZ47		TYN608
SF5G41A	TYN608	
SF5G42	TS820-600T	
SF5G48		TYN608
SF5J41A	TYN608	
SF5J42	TS820-600T	
SF5J48		TYN608

INDUSTRY STANDARD	ST EQUIVALENT	ST NEAREST
SF8G41A	TYN612	
SF8G48		TYN612
SF8J48		TYN612
SH8G41		TYN412
SHR0R3D42	X00602MA	
SM08G43	Z0103MA	
SM08G43	Z0103MA	
SM08G43	Z0103MA	
SM12G45	BTB12-600CW	
SM12G45A	BTB12-600SW	
SM12G48		BTB12-600CW
SM12G48A		BTB12-600SW
SM12J45	BTB12-600CW	
SM12J45A	BTB12-600SW	
SM12J48		BTB12-600CW
SM12J48A		BTB12-600SW
SM16G45	BTB16-600CW	
SM16G45A	BTB16-600SW	
SM16G48		BTB16-600CW
SM16G48A		BTB16-600SW
SM16J45	BTB16-600CW	
SM16J45A	BTB16-600SW	
SM16J48		BTB16-600CW
SM16J48A		BTB16-600SW
SM1G43	Z00607MA	
SM1G43	Z00607MA	
SM1G43	Z00607MA	
SM1J43	Z00607MA	
SM1J43	Z00607MA	
SM1J43	Z00607MA	
SM1L43	Z0107NA	
SM1L43	Z0107NA	
SM25GZ51		BTA26-800CW
SM25JZ51		BTA26-800CW
SM2GZ47		Z0409MF
SM2GZ47		Z0409MF
SM2GZ47A		Z0405MF
SM2JZ47		Z0409MF
SM2JZ47		Z0409MF
SM2JZ47A		Z0405MF
SM2LZ47		Z0409NF
SM3G45	T410-600T	
SM3G48		Z0410MF
SM3G48		Z0410MF
SM3GZ47	T410-600W	
SM3J45	T410-600T	
SM3J48		Z0410MF
SM3J48		Z0410MF
SM3JZ47	T410-600W	
SM6G45	BTB06-600CW	
SM6G45A	BTB06-600SW	
SM6G48		BTB06-600CW
SM6G48A		BTB06-600SW
SM6J45	BTB06-600CW	
SM6J45A	BTB06-600SW	
SM6J48		BTB06-600CW
SM6J48A		BTB06-600SW
SM8G45	BTB08-600CW	
SM8G45A	BTB08-600SW	
SM8G48		BTB08-600CW
SM8G48A		BTB08-600SW
SM8J45	BTB08-600CW	
SM8J45A	BTB08-600SW	
SM8J48		BTB08-600CW
SM8J48A		BTB08-600SW
URSF05G49-1P	P0102DN	
URSF05G49-3P	P0102DN	
URSF05G49-5P	P0102DN	

APPLICATION NOTES

Available on ST web site "<http://www.st.com>"

<i>THYRISTORS and TRIACs, on important parameters - the holding current</i>	AN302
<i>Latching current</i>	AN303
<i>Use of TRIACs on inductive loads</i>	AN307
<i>Control by a TRIAC of an inductive load - How to select a suitable circuit ?</i>	AN308
<i>Protect your TRIACs</i>	AN328
<i>TRIAC control by pulse transformer</i>	AN436
<i>New TRIACs - is the snubber circuit necessary ?</i>	AN437
<i>TRIACs + MICROCONTROLLER, safety precautions for development tools</i>	AN438
<i>Improvement in the TRIAC commutation</i>	AN439
<i>TRIAC drive circuit for operation in quadrants I and III</i>	AN440
<i>TRIACs for microwave ovens</i>	AN441
<i>TRIACs and MICROCONTROLLERS - the easy connection</i>	AN442
<i>SCRs and TRIACs thermal management - precaution for Handling and mounting</i>	AN533
<i>SCRs and TRIACs dice</i>	AN858
<i>SCRs and TRIACs in automotive applications</i>	AN871
<i>The new ACS™ series for home appliances: a breakthrough in ruggedness and drive for home appliances</i>	AN1172
<i>Ring wave tests with ACS402 / ACS108 driving valves and pumps</i>	AN1296
<i>ST6200C software description for cooling thermostat application</i>	AN1353
<i>Z01 and ACS comparison toward fast voltage transient</i>	AN1379
<i>CLT3-4BT6 demoboard: check the robustness of the CLT3-4BT6</i>	AN1608

ASD™ and Discrete Products



THYRISTORS

- . SCR (Silicon Controlled Rectifiers)
- . TRIACs
- . DIACs
- . IGNITORS
- . AC switches

RECTIFIERS

- . Signal Schottky
- . Power Schottky
- . Ultrafast and TURBOSWITCH™
- . Deflection diodes
- . RF diodes
- . PeakClamp

PROTECTION

- . TRANSIL™
- . TRISIL™
- . Protection ICs
- . Data Protection

IPAD™

(Integrated Passive and Active Devices)

- . Computer IPADs
- . Telecom IPADs

