

SN54HC14, SN74HC14 HEX SCHMITT-TRIGGER INVERTERS

SCLS085C – DECEMBER 1982 – REVISED NOVEMBER 2002

- Wide Operating Voltage Range of 2 V to 6 V
- Outputs Can Drive Up to 10 LSTTL Loads
- Low Power Consumption, 20- μ A Max I_{CC}
- Typical $t_{pd} = 11$ ns
- ± 4 -mA Output Drive at 5 V
- Low Input Current of 1 μ A Max

SN54HC14 . . . J OR W PACKAGE
SN74HC14 . . . D, DB, N, NS, OR PW PACKAGE
(TOP VIEW)

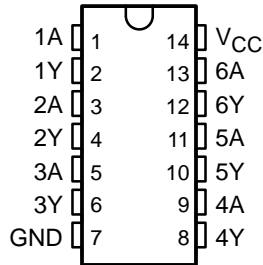

SN54HC14 . . . FK PACKAGE
(TOP VIEW)

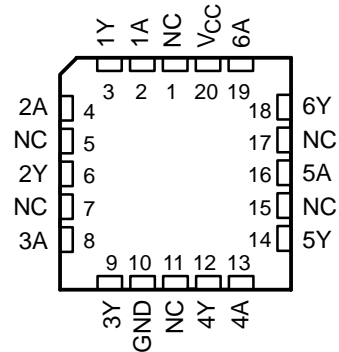

NC – No internal connection

description/ordering information

These Schmitt-trigger devices contain six independent inverters. They perform the Boolean function $Y = \bar{A}$ in positive logic.

ORDERING INFORMATION

| T_A | PACKAGE† | | ORDERABLE PART NUMBER | TOP-SIDE MARKING |
|----------------|------------|---------------|-----------------------|------------------|
| -40°C to 85°C | PDIP – N | Tube | SN74HC14N | SN74HC14N |
| | SOIC – D | Tube | SN74HC14D | HC14 |
| | | Tape and reel | SN74HC14DR | |
| | SOP – NS | Tape and reel | SN74HC14NSR | HC14 |
| | SSOP – DB | Tape and reel | SN74HC14DBR | HC14 |
| | TSSOP – PW | Tube | SN74HC14PW | HC14 |
| Tape and reel | | SN74HC14PWR | | |
| -55°C to 125°C | CDIP – J | Tube | SNJ54HC14J | SNJ54HC14J |
| | CFP – W | Tube | SNJ54HC14W | SNJ54HC14W |
| | LCCC – FK | Tube | SNJ54HC14FK | SNJ54HC14FK |

† Package drawings, standard packing quantities, thermal data, symbolization, and PCB design guidelines are available at www.ti.com/sc/package.

FUNCTION TABLE
(each inverter)

| INPUT A | OUTPUT Y |
|------------|-------------|
| H | L |
| L | H |



Please be aware that an important notice concerning availability, standard warranty, and use in critical applications of Texas Instruments semiconductor products and disclaimers thereto appears at the end of this data sheet.

PRODUCTION DATA information is current as of publication date. Products conform to specifications per the terms of Texas Instruments standard warranty. Production processing does not necessarily include testing of all parameters.

 **TEXAS
INSTRUMENTS**

POST OFFICE BOX 655303 • DALLAS, TEXAS 75265

Copyright © 2002, Texas Instruments Incorporated
On products compliant to MIL-PRF-38535, all parameters are tested unless otherwise noted. On all other products, production processing does not necessarily include testing of all parameters.

SN54HC14, SN74HC14 HEX SCHMITT-TRIGGER INVERTERS

SCLS085C – DECEMBER 1982 – REVISED NOVEMBER 2002

logic diagram (positive logic)



absolute maximum ratings over operating free-air temperature range (unless otherwise noted)†

| | |
|---|----------------|
| Supply voltage range, V_{CC} | -0.5 V to 7 V |
| Input clamp current, I_{IK} ($V_I < 0$ or $V_I > V_{CC}$) (see Note 1) | ± 20 mA |
| Output clamp current, I_{OK} ($V_O < 0$ or $V_O > V_{CC}$) (see Note 1) | ± 20 mA |
| Continuous output current, I_O ($V_O = 0$ to V_{CC}) | ± 25 mA |
| Continuous current through V_{CC} or GND | ± 50 mA |
| Package thermal impedance, θ_{JA} (see Note 2): D package | 86°C/W |
| DB package | 96°C/W |
| N package | 80°C/W |
| NS package | 76°C/W |
| PW package | 113°C/W |
| Storage temperature range, T_{stg} | -65°C to 150°C |

† Stresses beyond those listed under “absolute maximum ratings” may cause permanent damage to the device. These are stress ratings only, and functional operation of the device at these or any other conditions beyond those indicated under “recommended operating conditions” is not implied. Exposure to absolute-maximum-rated conditions for extended periods may affect device reliability.

- NOTES: 1. The input and output voltage ratings may be exceeded if the input and output current ratings are observed.
2. The package thermal impedance is calculated in accordance with JESD 51-7.

recommended operating conditions (see Note 3)

| | SN54HC14 | | | SN74HC14 | | | UNIT |
|--------------------------------------|----------------|----------|-----|----------|----------|-----|------|
| | MIN | NOM | MAX | MIN | NOM | MAX | |
| V_{CC} Supply voltage | 2 | 5 | 6 | 2 | 5 | 6 | V |
| V_{IL} Low-level input voltage | $V_{CC} = 6$ V | | | 1.8 | | | V |
| V_I Input voltage | 0 | V_{CC} | | 0 | V_{CC} | | V |
| V_O Output voltage | 0 | V_{CC} | | 0 | V_{CC} | | V |
| T_A Operating free-air temperature | -55 | 125 | | -40 | 85 | | °C |

NOTE 3: All unused inputs of the device must be held at V_{CC} or GND to ensure proper device operation. Refer to the TI application report, *Implications of Slow or Floating CMOS Inputs*, literature number SCBA004.

SN54HC14, SN74HC14 HEX SCHMITT-TRIGGER INVERTERS

SCLS085C – DECEMBER 1982 – REVISED NOVEMBER 2002

electrical characteristics over recommended operating free-air temperature range (unless otherwise noted)

| PARAMETER | TEST CONDITIONS | | V _{CC} | T _A = 25°C | | | SN54HC14 | | SN74HC14 | | UNIT |
|-----------------------------------|---|---------------------------|-----------------|-----------------------|-------|------|----------|-------|----------|-------|------|
| | | | | MIN | TYP | MAX | MIN | MAX | MIN | MAX | |
| V _{T+} | | | 2 V | 0.7 | 1.2 | 1.5 | 0.7 | 1.5 | 0.7 | 1.5 | V |
| | | | 4.5 V | 1.55 | 2.5 | 3.15 | 1.55 | 3.15 | 1.55 | 3.15 | |
| | | | 6 V | 2.1 | 3.3 | 4.2 | 2.1 | 4.2 | 2.1 | 4.2 | |
| V _{T-} | | | 2 V | 0.3 | 0.6 | 1 | 0.3 | 1 | 0.3 | 1 | V |
| | | | 4.5 V | 0.9 | 1.6 | 2.45 | 0.9 | 2.45 | 0.9 | 2.45 | |
| | | | 6 V | 1.2 | 2 | 3.2 | 1.2 | 3.2 | 1.2 | 3.2 | |
| V _{T+} - V _{T-} | | | 2 V | 0.2 | 0.6 | 1.2 | 0.2 | 1.2 | 0.2 | 1.2 | V |
| | | | 4.5 V | 0.4 | 0.9 | 2.1 | 0.4 | 2.1 | 0.4 | 2.1 | |
| | | | 6 V | 0.5 | 1.3 | 2.5 | 0.5 | 2.5 | 0.5 | 2.5 | |
| V _{OH} | V _I = V _{IH} or V _{IL} | I _{OH} = -20 μA | 2 V | 1.9 | 1.998 | | 1.9 | | 1.9 | V | |
| | | | 4.5 V | 4.4 | 4.499 | | 4.4 | | 4.4 | | |
| | | | 6 V | 5.9 | 5.999 | | 5.9 | | 5.9 | | |
| | | I _{OH} = -4 mA | 4.5 V | 3.98 | 4.3 | | 3.7 | | 3.84 | | |
| | | I _{OH} = -5.2 mA | 6 V | 5.48 | 5.8 | | 5.2 | | 5.34 | | |
| V _{OL} | V _I = V _{IH} or V _{IL} | I _{OL} = 20 μA | 2 V | | 0.002 | 0.1 | | 0.1 | | 0.1 | V |
| | | | 4.5 V | | 0.001 | 0.1 | | 0.1 | | 0.1 | |
| | | | 6 V | | 0.001 | 0.1 | | 0.1 | | 0.1 | |
| | | I _{OL} = 4 mA | 4.5 V | | 0.17 | 0.26 | | 0.4 | | 0.33 | |
| | | I _{OL} = 5.2 mA | 6 V | | 0.15 | 0.26 | | 0.4 | | 0.33 | |
| I _I | V _I = V _{CC} or 0 | | 6 V | | ±0.1 | ±100 | | ±1000 | | ±1000 | nA |
| I _{CC} | V _I = V _{CC} or 0, I _O = 0 | | 6 V | | | 2 | | 40 | | 20 | μA |
| C _i | | | 2 V to 6 V | | 3 | 10 | | 10 | | 10 | pF |

switching characteristics over recommended operating free-air temperature range, C_L = 50 pF (unless otherwise noted) (see Figure 1)

| PARAMETER | FROM (INPUT) | TO (OUTPUT) | V _{CC} | T _A = 25°C | | | SN54HC14 | | SN74HC14 | | UNIT |
|-----------------|--------------|-------------|-----------------|-----------------------|-----|-----|----------|-----|----------|-----|------|
| | | | | MIN | TYP | MAX | MIN | MAX | MIN | MAX | |
| t _{pd} | A | Y | 2 V | | 55 | 125 | | 190 | | 155 | ns |
| | | | 4.5 V | | 12 | 25 | | 38 | | 31 | |
| | | | 6 V | | 11 | 21 | | 32 | | 26 | |
| t _t | | Y | 2 V | | 38 | 75 | | 110 | | 95 | ns |
| | | | 4.5 V | | 8 | 15 | | 22 | | 19 | |
| | | | 6 V | | 6 | 13 | | 19 | | 16 | |

operating characteristics, T_A = 25°C

| PARAMETER | TEST CONDITIONS | TYP | UNIT |
|--|-----------------|-----|------|
| C _{pd} Power dissipation capacitance per inverter | No load | 20 | pF |



SN54HC14, SN74HC14 HEX SCHMITT-TRIGGER INVERTERS

SCLS085C – DECEMBER 1982 – REVISED NOVEMBER 2002

PARAMETER MEASUREMENT INFORMATION

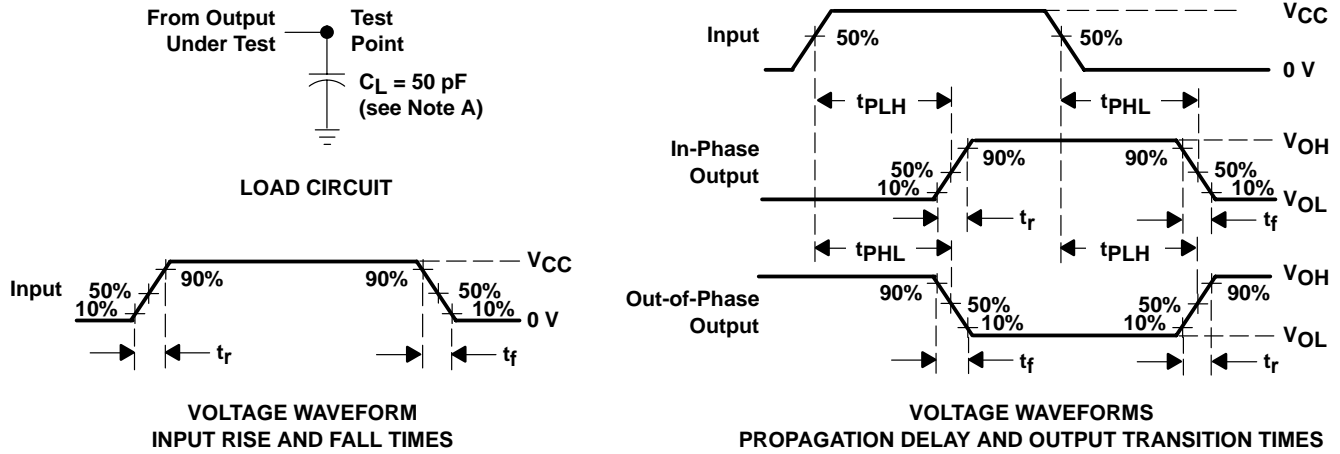

- NOTES:
- A. C_L includes probe and test-fixture capacitance.
 - B. Phase relationships between waveforms were chosen arbitrarily. All input pulses are supplied by generators having the following characteristics: $PRR \leq 1 \text{ MHz}$, $Z_O = 50 \Omega$, $t_r = 6 \text{ ns}$, $t_f = 6 \text{ ns}$.
 - C. The outputs are measured one at a time with one input transition per measurement.
 - D. t_{PLH} and t_{PHL} are the same as t_{pd} .

Figure 1. Load Circuit and Voltage Waveforms

J (R-GDIP-T**)

14 LEADS SHOWN

CERAMIC DUAL IN-LINE PACKAGE



| DIM \ PINS ** | 14 | 16 | 18 | 20 |
|---------------|------------------------|------------------------|------------------------|------------------------|
| A | 0.300 (7,62) BSC | 0.300 (7,62) BSC | 0.300 (7,62) BSC | 0.300 (7,62) BSC |
| B MAX | 0.785 (19,94) | .840 (21,34) | 0.960 (24,38) | 1.060 (26,92) |
| B MIN | — | — | — | — |
| C MAX | 0.300 (7,62) | 0.300 (7,62) | 0.310 (7,87) | 0.300 (7,62) |
| C MIN | 0.245 (6,22) | 0.245 (6,22) | 0.220 (5,59) | 0.245 (6,22) |



4040083/F 03/03

- NOTES:
- All linear dimensions are in inches (millimeters).
 - This drawing is subject to change without notice.
 - This package is hermetically sealed with a ceramic lid using glass frit.
 - Index point is provided on cap for terminal identification only on press ceramic glass frit seal only.
 - Falls within MIL STD 1835 GDIP1-T14, GDIP1-T16, GDIP1-T18 and GDIP1-T20.

W (R-GDFP-F14)

CERAMIC DUAL FLATPACK

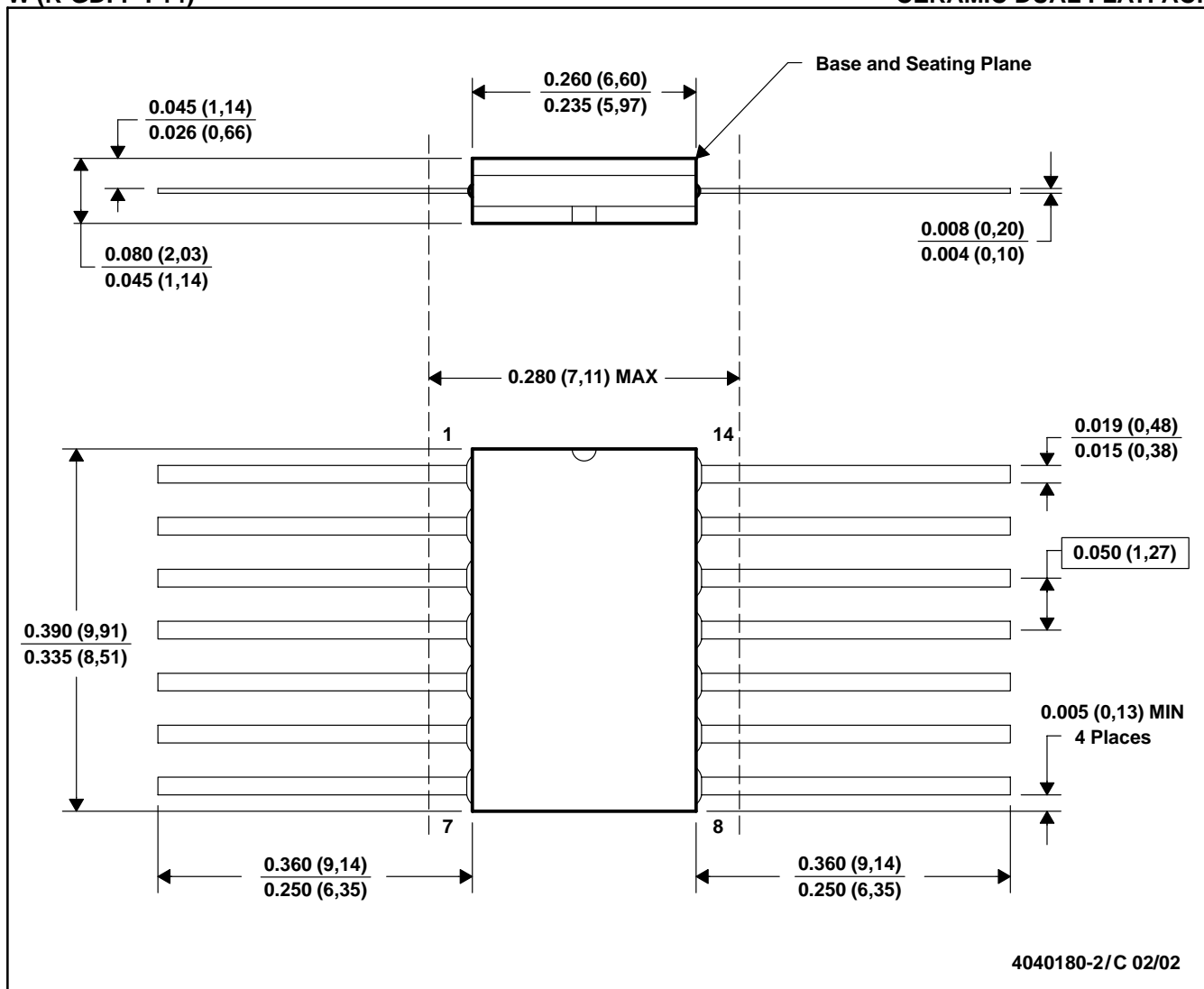

- NOTES: A. All linear dimensions are in inches (millimeters).
 B. This drawing is subject to change without notice.
 C. This package can be hermetically sealed with a ceramic lid using glass frit.
 D. Index point is provided on cap for terminal identification only.
 E. Falls within MIL STD 1835 GDFP1-F14 and JEDEC MO-092AB

FK (S-CQCC-N**)

LEADLESS CERAMIC CHIP CARRIER

28 TERMINAL SHOWN



- NOTES:
- A. All linear dimensions are in inches (millimeters).
 - B. This drawing is subject to change without notice.
 - C. This package can be hermetically sealed with a metal lid.
 - D. The terminals are gold plated.
 - E. Falls within JEDEC MS-004

N (R-PDIP-T**)

PLASTIC DUAL-IN-LINE PACKAGE

16 PINS SHOWN

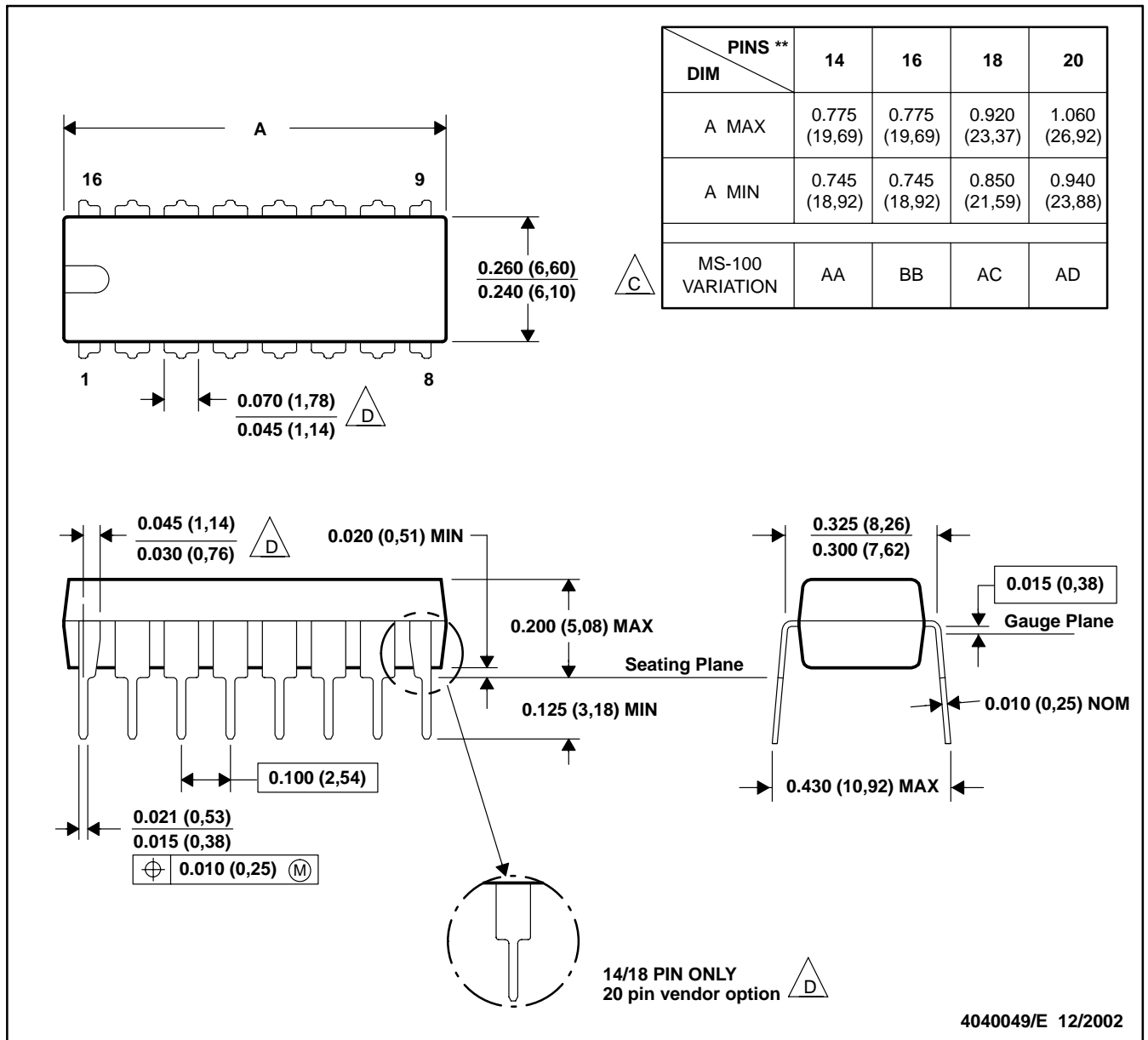

NOTES: A. All linear dimensions are in inches (millimeters).
 B. This drawing is subject to change without notice.

 Falls within JEDEC MS-001, except 18 and 20 pin minimum body length (Dim A).

 The 20 pin end lead shoulder width is a vendor option, either half or full width.

D (R-PDSO-G**)

PLASTIC SMALL-OUTLINE PACKAGE

8 PINS SHOWN



- NOTES: A. All linear dimensions are in inches (millimeters).
 B. This drawing is subject to change without notice.
 C. Body dimensions do not include mold flash or protrusion, not to exceed 0.006 (0,15).
 D. Falls within JEDEC MS-012

MECHANICAL DATA

NS (R-PDSO-G)**

PLASTIC SMALL-OUTLINE PACKAGE

14-PINS SHOWN



- NOTES:
- A. All linear dimensions are in millimeters.
 - B. This drawing is subject to change without notice.
 - C. Body dimensions do not include mold flash or protrusion, not to exceed 0,15.

DB (R-PDSO-G**)

PLASTIC SMALL-OUTLINE

28 PINS SHOWN



- NOTES: A. All linear dimensions are in millimeters.
 B. This drawing is subject to change without notice.
 C. Body dimensions do not include mold flash or protrusion not to exceed 0,15.
 D. Falls within JEDEC MO-150

PW (R-PDSO-G**)

PLASTIC SMALL-OUTLINE PACKAGE

14 PINS SHOWN



- NOTES: A. All linear dimensions are in millimeters.
 B. This drawing is subject to change without notice.
 C. Body dimensions do not include mold flash or protrusion not to exceed 0,15.
 D. Falls within JEDEC MO-153

IMPORTANT NOTICE

Texas Instruments Incorporated and its subsidiaries (TI) reserve the right to make corrections, modifications, enhancements, improvements, and other changes to its products and services at any time and to discontinue any product or service without notice. Customers should obtain the latest relevant information before placing orders and should verify that such information is current and complete. All products are sold subject to TI's terms and conditions of sale supplied at the time of order acknowledgment.

TI warrants performance of its hardware products to the specifications applicable at the time of sale in accordance with TI's standard warranty. Testing and other quality control techniques are used to the extent TI deems necessary to support this warranty. Except where mandated by government requirements, testing of all parameters of each product is not necessarily performed.

TI assumes no liability for applications assistance or customer product design. Customers are responsible for their products and applications using TI components. To minimize the risks associated with customer products and applications, customers should provide adequate design and operating safeguards.

TI does not warrant or represent that any license, either express or implied, is granted under any TI patent right, copyright, mask work right, or other TI intellectual property right relating to any combination, machine, or process in which TI products or services are used. Information published by TI regarding third-party products or services does not constitute a license from TI to use such products or services or a warranty or endorsement thereof. Use of such information may require a license from a third party under the patents or other intellectual property of the third party, or a license from TI under the patents or other intellectual property of TI.

Reproduction of information in TI data books or data sheets is permissible only if reproduction is without alteration and is accompanied by all associated warranties, conditions, limitations, and notices. Reproduction of this information with alteration is an unfair and deceptive business practice. TI is not responsible or liable for such altered documentation.

Resale of TI products or services with statements different from or beyond the parameters stated by TI for that product or service voids all express and any implied warranties for the associated TI product or service and is an unfair and deceptive business practice. TI is not responsible or liable for any such statements.

Mailing Address:

Texas Instruments
Post Office Box 655303
Dallas, Texas 75265