

MJE13009*

*Motorola Preferred Device

**12 AMPERE
NPN SILICON
POWER TRANSISTOR
400 VOLTS
100 WATTS**

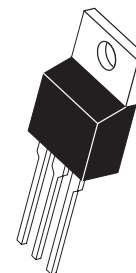

**CASE 221A-06
TO-220AB**

Designer's™ Data Sheet

SWITCHMODE Series

NPN Silicon Power Transistors

The MJE13009 is designed for high-voltage, high-speed power switching inductive circuits where fall time is critical. They are particularly suited for 115 and 220 V switchmode applications such as Switching Regulators, Inverters, Motor Controls, Solenoid/Relay drivers and Deflection circuits.

SPECIFICATION FEATURES:

- $V_{CEO(sus)}$ 400 V and 300 V
- Reverse Bias SOA with Inductive Loads @ $T_C = 100^\circ\text{C}$
- Inductive Switching Matrix 3 to 12 Amp, 25 and 100°C
... t_C @ 8 A, 100°C is 120 ns (Typ).
- 700 V Blocking Capability
- SOA and Switching Applications Information.

MAXIMUM RATINGS

Rating	Symbol	Value	Unit
Collector-Emitter Voltage	$V_{CEO(sus)}$	400	Vdc
Collector-Emitter Voltage	V_{CEV}	700	Vdc
Emitter Base Voltage	V_{EBO}	9	Vdc
Collector Current — Continuous	I_C	12	Adc
— Peak (1)	I_{CM}	24	
Base Current — Continuous	I_B	6	Adc
— Peak (1)	I_{BM}	12	
Emitter Current — Continuous	I_E	18	Adc
— Peak (1)	I_{EM}	36	
Total Power Dissipation @ $T_A = 25^\circ\text{C}$ Derate above 25°C	P_D	2 16	Watts mW/ $^\circ\text{C}$
Total Power Dissipation @ $T_C = 25^\circ\text{C}$ Derate above 25°C	P_D	100 800	Watts mW/ $^\circ\text{C}$
Operating and Storage Junction Temperature Range	T_J, T_{stg}	-65 to +150	$^\circ\text{C}$

THERMAL CHARACTERISTICS

Characteristic	Symbol	Max	Unit
Thermal Resistance, Junction to Ambient	$R_{\theta JA}$	62.5	$^\circ\text{C}/\text{W}$
Thermal Resistance, Junction to Case	$R_{\theta JC}$	1.25	$^\circ\text{C}/\text{W}$
Maximum Lead Temperature for Soldering Purposes: 1/8" from Case for 5 Seconds	T_L	275	$^\circ\text{C}$

(1) Pulse Test: Pulse Width = 5 ms, Duty Cycle \leq 10%.

Designer's Data for "Worst Case" Conditions — The Designer's Data Sheet permits the design of most circuits entirely from the information presented. SOA Limit curves — representing boundaries on device characteristics — are given to facilitate "worst case" design.

Preferred devices are Motorola recommended choices for future use and best overall value.

REV 2

ELECTRICAL CHARACTERISTICS ($T_C = 25^\circ\text{C}$ unless otherwise noted)

Characteristic	Symbol	Min	Typ	Max	Unit
*OFF CHARACTERISTICS					
Collector–Emitter Sustaining Voltage ($I_C = 10\text{ mA}$, $I_B = 0$)	$V_{CEO(sus)}$	400	—	—	Vdc
Collector Cutoff Current ($V_{CEV} = \text{Rated Value}$, $V_{BE(off)} = 1.5\text{ Vdc}$) ($V_{CEV} = \text{Rated Value}$, $V_{BE(off)} = 1.5\text{ Vdc}$, $T_C = 100^\circ\text{C}$)	I_{CEV}	— —	— —	1 5	mAdc
Emitter Cutoff Current ($V_{EB} = 9\text{ Vdc}$, $I_C = 0$)	I_{EBO}	—	—	1	mAdc

SECOND BREAKDOWN

Second Breakdown Collector Current with base forward biased Clamped Inductive SOA with Base Reverse Biased	$I_{S/b}$ —	See Figure 1 See Figure 2			
---------------------------------------------------------------------------------------------------------------	----------------	------------------------------	--	--	--

***ON CHARACTERISTICS**

DC Current Gain ($I_C = 5\text{ Adc}$, $V_{CE} = 5\text{ Vdc}$) ($I_C = 8\text{ Adc}$, $V_{CE} = 5\text{ Vdc}$)	h_{FE}	8 6	— —	40 30	
Collector–Emitter Saturation Voltage ($I_C = 5\text{ Adc}$, $I_B = 1\text{ Adc}$) ($I_C = 8\text{ Adc}$, $I_B = 1.6\text{ Adc}$) ($I_C = 12\text{ Adc}$, $I_B = 3\text{ Adc}$) ($I_C = 8\text{ Adc}$, $I_B = 1.6\text{ Adc}$, $T_C = 100^\circ\text{C}$)	$V_{CE(sat)}$	— — — —	— — — —	1 1.5 3 2	Vdc
Base–Emitter Saturation Voltage ($I_C = 5\text{ Adc}$, $I_B = 1\text{ Adc}$) ($I_C = 8\text{ Adc}$, $I_B = 1.6\text{ Adc}$) ($I_C = 8\text{ Adc}$, $I_B = 1.6\text{ Adc}$, $T_C = 100^\circ\text{C}$)	$V_{BE(sat)}$	— — —	— — —	1.2 1.6 1.5	Vdc

DYNAMIC CHARACTERISTICS

Current–Gain — Bandwidth Product ($I_C = 500\text{ mAdc}$, $V_{CE} = 10\text{ Vdc}$, $f = 1\text{ MHz}$)	f_T	4	—	—	MHz
Output Capacitance ($V_{CB} = 10\text{ Vdc}$, $I_E = 0$, $f = 0.1\text{ MHz}$)	C_{ob}	—	180	—	pF

SWITCHING CHARACTERISTICS

Resistive Load (Table 1)						
Delay Time	$(V_{CC} = 125\text{ Vdc}$, $I_C = 8\text{ A}$, $I_{B1} = I_{B2} = 1.6\text{ A}$, $t_p = 25\text{ }\mu\text{s}$, Duty Cycle $\leq 1\%$)	t_d	—	0.06	0.1	μs
Rise Time		t_r	—	0.45	1	μs
Storage Time		t_s	—	1.3	3	μs
Fall Time		t_f	—	0.2	0.7	μs
Inductive Load, Clamped (Table 1, Figure 13)						
Voltage Storage Time	$(I_C = 8\text{ A}$, $V_{clamp} = 300\text{ Vdc}$, $I_{B1} = 1.6\text{ A}$, $V_{BE(off)} = 5\text{ Vdc}$, $T_C = 100^\circ\text{C}$)	t_{sv}	—	0.92	2.3	μs
Crossover Time		t_c	—	0.12	0.7	μs

*Pulse Test: Pulse Width = 300 μs , Duty Cycle = 2%.

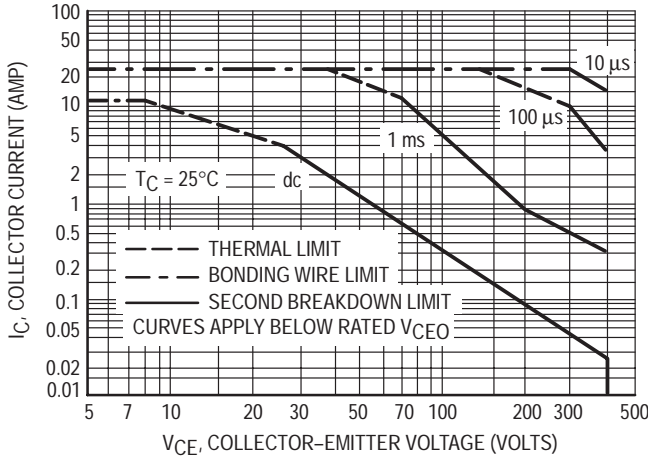

Figure 1. Forward Bias Safe Operating Area

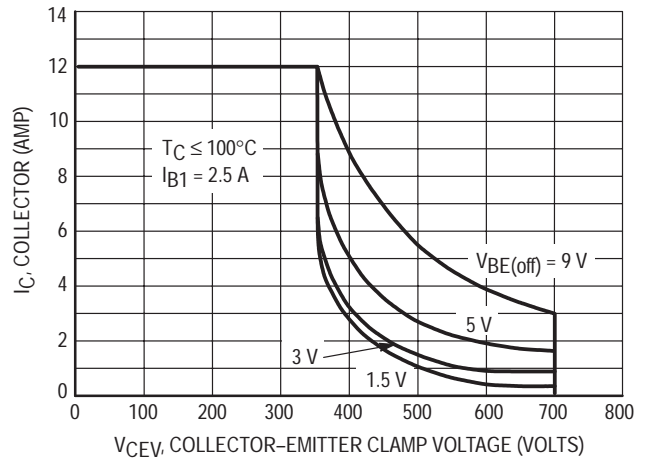

Figure 2. Reverse Bias Switching Safe Operating Area

The Safe Operating Area figures shown in Figures 1 and 2 are specified ratings for these devices under the test conditions shown.

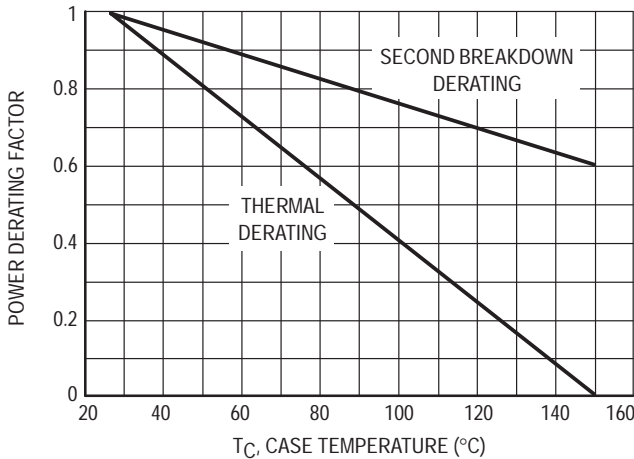

Figure 3. Forward Bias Power Derating

There are two limitations on the power handling ability of a transistor: average junction temperature and second breakdown. Safe operating area curves indicate $I_C - V_{CE}$ limits of the transistor that must be observed for reliable operation; i.e., the transistor must not be subjected to greater dissipation than the curves indicate.

The data of Figure 1 is based on $T_C = 25^\circ\text{C}$; $T_{J(pk)}$ is variable depending on power level. Second breakdown pulse limits are valid for duty cycles to 10% but must be derated when $T_C \geq 25^\circ\text{C}$. Second breakdown limitations do not derate the same as thermal limitations. Allowable current at the voltages shown on Figure 1 may be found at any case temperature by using the appropriate curve on Figure 3.

$T_{J(pk)}$ may be calculated from the data in Figure 4. At high case temperatures, thermal limitations will reduce the power that can be handled to values less than the limitations imposed by second breakdown. Use of reverse biased safe operating area data (Figure 2) is discussed in the applications information section.

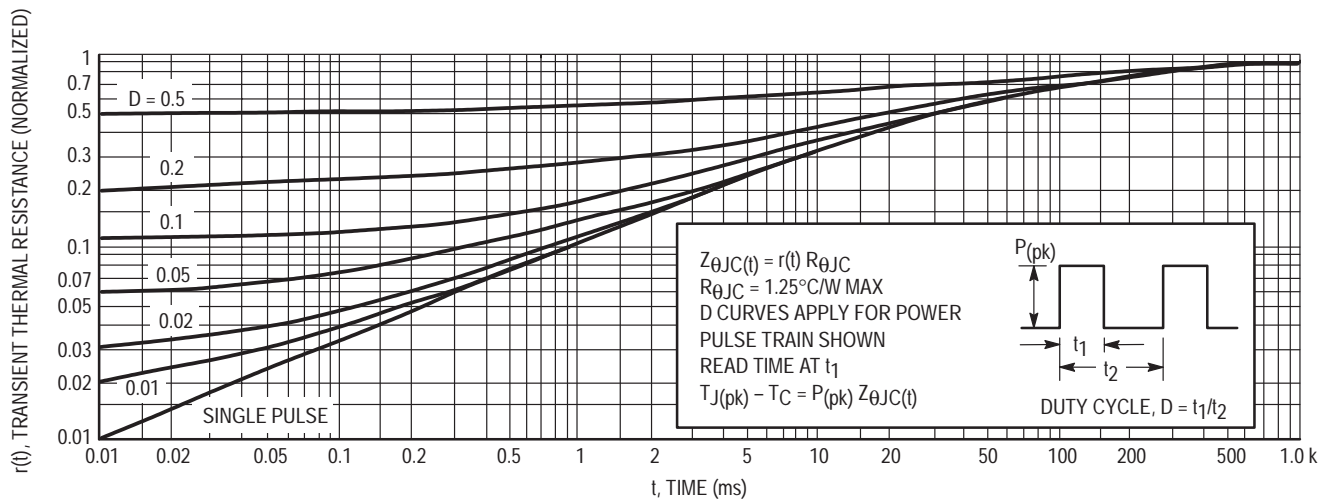

Figure 4. Typical Thermal Response [$Z_{\theta JC}(t)$]

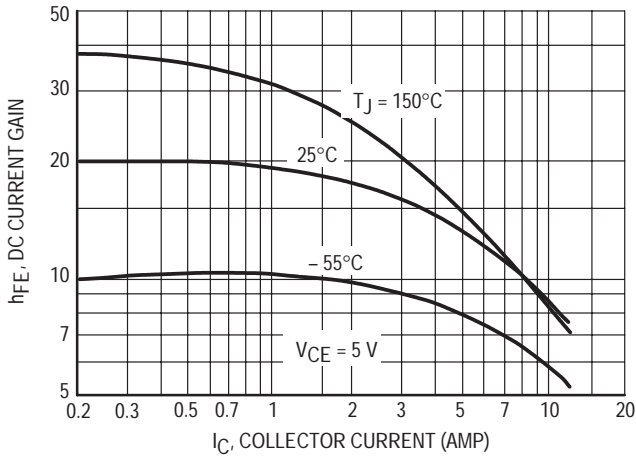

Figure 5. DC Current Gain

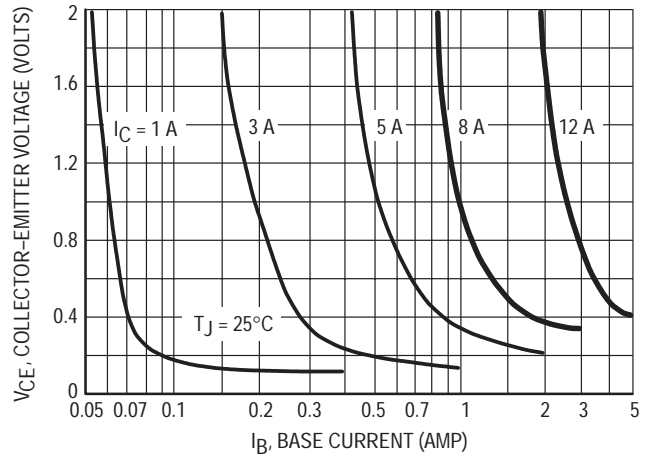

Figure 6. Collector Saturation Region

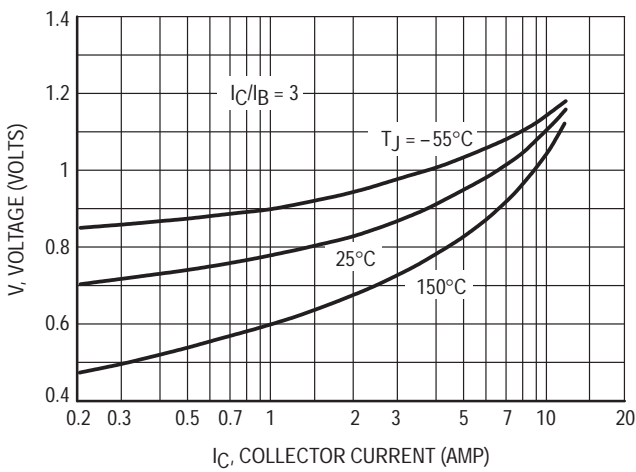

Figure 7. Base-Emitter Saturation Voltage

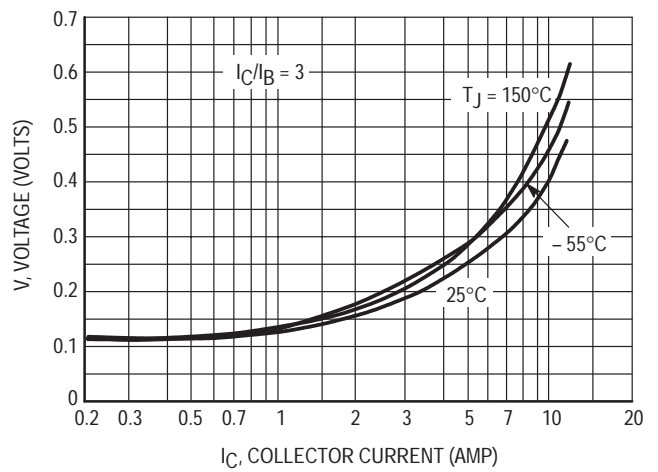

Figure 8. Collector-Emitter Saturation Voltage

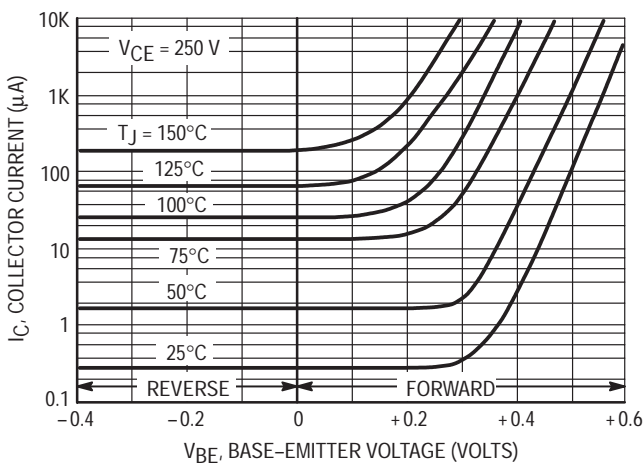

Figure 9. Collector Cutoff Region

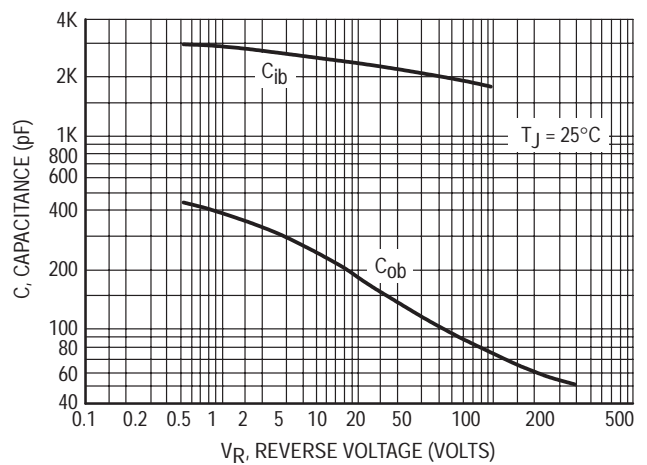

Figure 10. Capacitance

Table 1. Test Conditions for Dynamic Performance

REVERSE BIAS SAFE OPERATING AREA AND INDUCTIVE SWITCHING		RESISTIVE SWITCHING
TEST CIRCUITS	<p>DUTY CYCLE $\leq 10\%$ $t_r, t_f \leq 10$ ns</p> <p>NOTE PW and V_{CC} Adjusted for Desired I_C R_B Adjusted for Desired I_{B1}</p>	
CIRCUIT VALUES	<p>Coil Data: Ferroxcube Core #6656 Full Bobbin (~16 Turns) #16</p> <p>GAP for 200 $\mu H/20$ A $L_{coil} = 200 \mu H$</p> <p>$V_{CC} = 20$ V $V_{clamp} = 300$ Vdc</p>	<p>$V_{CC} = 125$ V $R_C = 15 \Omega$ D1 = 1N5820 or Equiv. $R_B = \Omega$</p>
TEST WAVEFORMS	<p>OUTPUT WAVEFORMS</p> <p>t_1 ADJUSTED TO OBTAIN I_C $t_1 \approx \frac{L_{coil}(I_{CM})}{V_{CC}}$</p> <p>$t_2 \approx \frac{L_{coil}(I_{CM})}{V_{clamp}}$</p> <p>Test Equipment Scope-Tektronics 475 or Equivalent</p>	<p>$t_r, t_f < 10$ ns Duty Cycle = 1.0% R_B and R_C adjusted for desired I_B and I_C</p>

APPLICATIONS INFORMATION FOR SWITCHMODE SPECIFICATIONS

INTRODUCTION

The primary considerations when selecting a power transistor for SWITCHMODE applications are voltage and current ratings, switching speed, and energy handling capability. In this section, these specifications will be discussed and related to the circuit examples illustrated in Table 2.(1)

VOLTAGE REQUIREMENTS

Both blocking voltage and sustaining voltage are important in SWITCHMODE applications.

Circuits B and C in Table 2 illustrate applications that require high blocking voltage capability. In both circuits the switching transistor is subjected to voltages substantially higher than V_{CC} after the device is completely off (see load line diagrams at $I_C = I_{leakage} \approx 0$ in Table 2). The blocking capability at this point depends on the base to emitter conditions and the device junction temperature. Since the highest device capability occurs when the base to emitter junction is reverse biased (V_{CEV}), this is the recommended and specified use condition. Maximum I_{CEV} at rated V_{CEV} is specified at a relatively low reverse bias (1.5 Volts) both at 25°C and

100°C. Increasing the reverse bias will give some improvement in device blocking capability.

The sustaining or active region voltage requirements in switching applications occur during turn-on and turn-off. If the load contains a significant capacitive component, high current and voltage can exist simultaneously during turn-on and the pulsed forward bias SOA curves (Figure 1) are the proper design limits.

For inductive loads, high voltage and current must be sustained simultaneously during turn-off, in most cases, with the base to emitter junction reverse biased. Under these conditions the collector voltage must be held to a safe level at or below a specific value of collector current. This can be accomplished by several means such as active clamping, RC snubbing, load line shaping, etc. The safe level for these devices is specified as a Reverse Bias Safe Operating Area (Figure 2) which represents voltage-current conditions that can be sustained during reverse biased turn-off. This rating is verified under clamped conditions so that the device is never subjected to an avalanche mode.

(1) For detailed information on specific switching applications, see Motorola Application Notes AN-719, AN-767.

VOLTAGE REQUIREMENTS (continued)

In the four application examples (Table 2) load lines are shown in relation to the pulsed forward and reverse biased SOA curves.

In circuits A and D, inductive reactance is clamped by the diodes shown. In circuits B and C the voltage is clamped by the output rectifiers, however, the voltage induced in the primary leakage inductance is not clamped by these diodes and could be large enough to destroy the device. A snubber network or an additional clamp may be required to keep the turn-off load line within the Reverse Bias SOA curve.

Load lines that fall within the pulsed forward biased SOA curve during turn-on and within the reverse bias SOA curve during turn-off are considered safe, with the following assumptions:

- (1) The device thermal limitations are not exceeded.
- (2) The turn-on time does not exceed 10 μ s (see standard pulsed forward SOA curves in Figure 1).
- (3) The base drive conditions are within the specified limits shown on the Reverse Bias SOA curve (Figure 2).

CURRENT REQUIREMENTS

An efficient switching transistor must operate at the required current level with good fall time, high energy handling

capability and low saturation voltage. On this data sheet, these parameters have been specified at 8 amperes which represents typical design conditions for these devices. The current drive requirements are usually dictated by the $V_{CE(sat)}$ specification because the maximum saturation voltage is specified at a forced gain condition which must be duplicated or exceeded in the application to control the saturation voltage.

SWITCHING REQUIREMENTS

In many switching applications, a major portion of the transistor power dissipation occurs during the fall time (t_{fi}). For this reason considerable effort is usually devoted to reducing the fall time. The recommended way to accomplish this is to reverse bias the base-emitter junction during turn-off. The reverse biased switching characteristics for inductive loads are discussed in Figure 11 and Table 3 and resistive loads in Figures 13 and 14. Usually the inductive load component will be the dominant factor in SWITCHMODE applications and the inductive switching data will more closely represent the device performance in actual application. The inductive switching characteristics are derived from the same circuit used to specify the reverse biased SOA curves, (See Table 1) providing correlation between test procedures and actual use conditions.

RESISTIVE SWITCHING PERFORMANCE

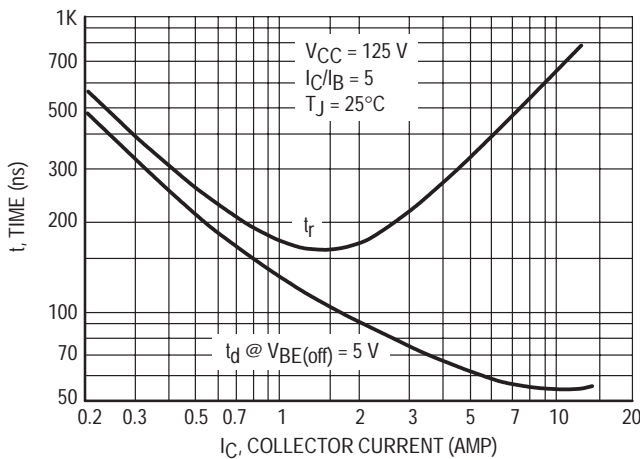

Figure 11. Turn-On Time

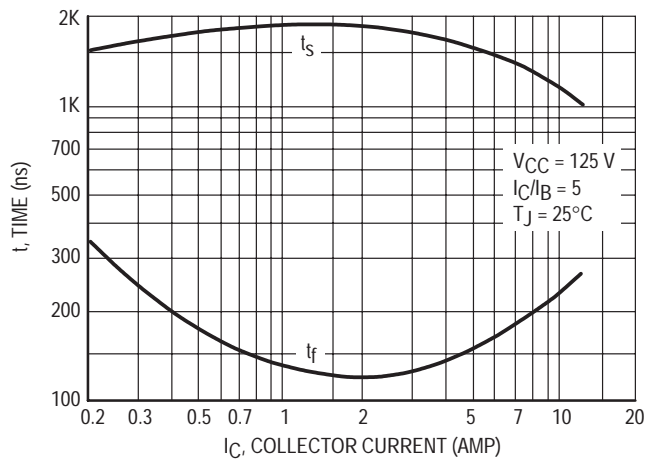

Figure 12. Turn-Off Time

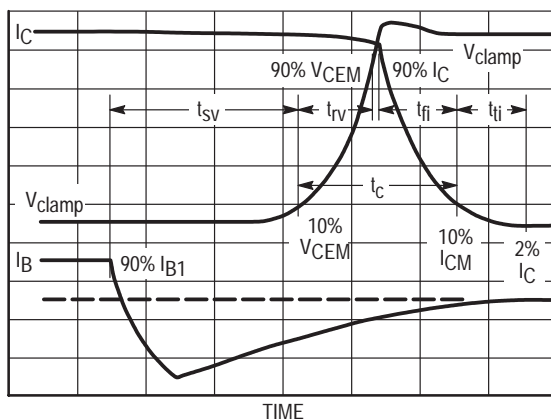

Figure 13. Inductive Switching Measurements

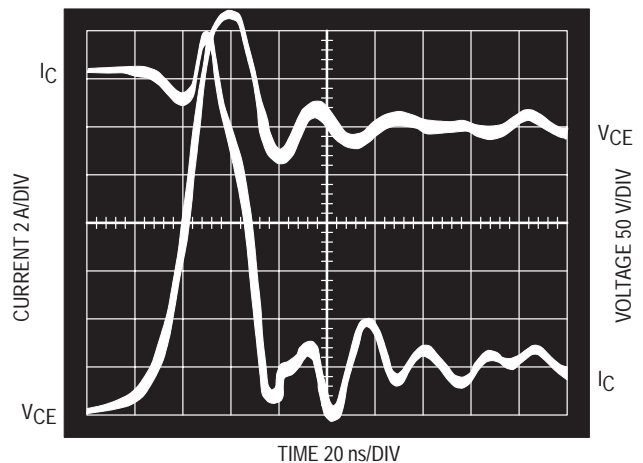

Figure 14. Typical Inductive Switching Waveforms (at 300 V and 12 A with $I_{B1} = 2.4$ A and $V_{BE(off)} = 5$ V)

Table 2. Applications Examples of Switching Circuits

CIRCUIT	LOAD LINE DIAGRAMS	TIME DIAGRAMS
<p>SERIES SWITCHING REGULATOR</p> 		
<p>RINGING CHOKE INVERTER</p> 		
<p>PUSH-PULL INVERTER/CONVERTER</p> 		
<p>SOLENOID DRIVER</p> 		

Table 3. Typical Inductive Switching Performance

I _C AMP	T _C °C	t _{sv} ns	t _{rv} ns	t _{fi} ns	t _{tj} ns	t _c ns
3	25	770	100	150	200	240
	100	1000	230	160	200	320
5	25	630	72	26	10	100
	100	820	100	55	30	180
8	25	720	55	27	2	77
	100	920	70	50	8	120
12	25	640	20	17	2	41
	100	800	32	24	4	54

NOTE: All Data recorded In the Inductive Switching Circuit In Table 1.

SWITCHING TIME NOTES

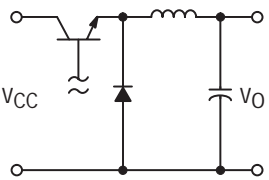
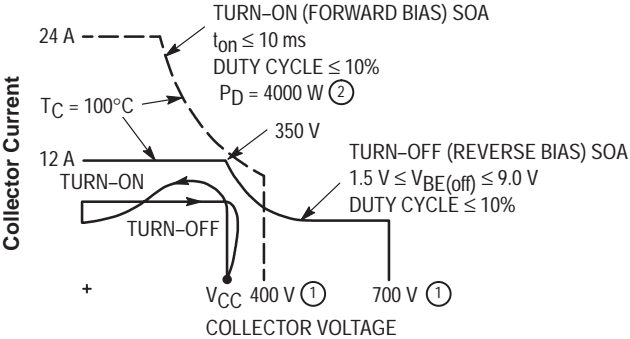
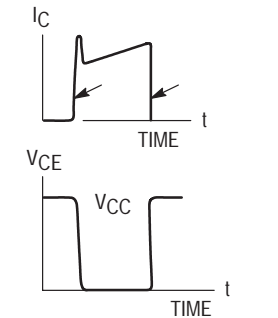
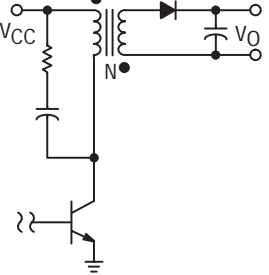
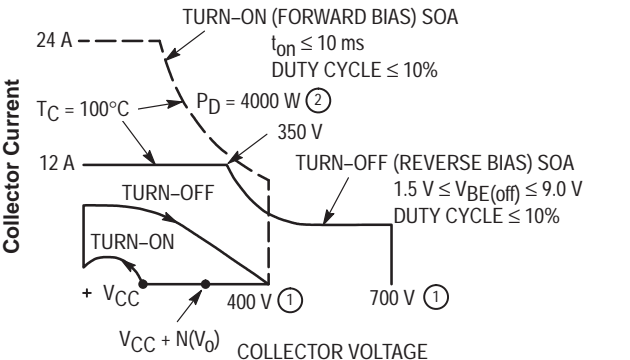
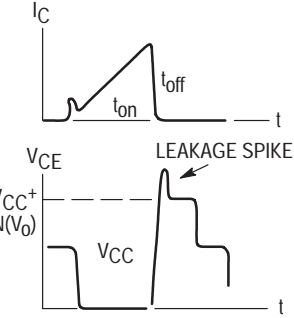
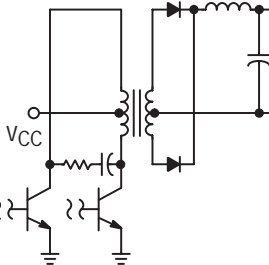
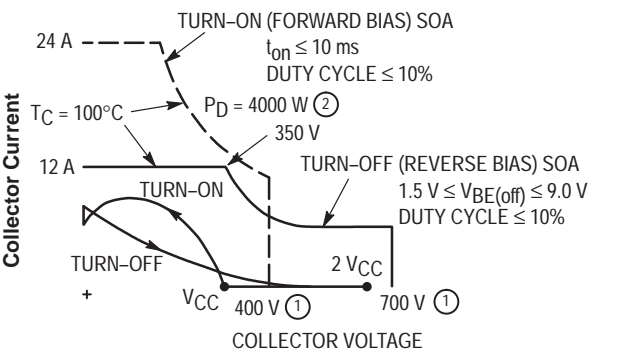
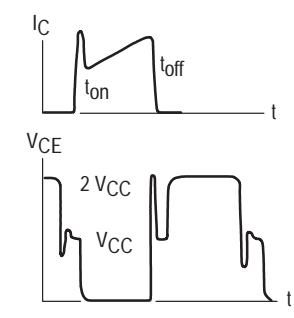
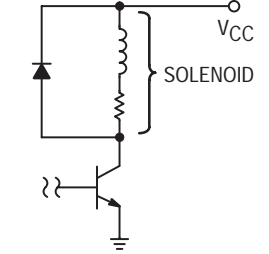
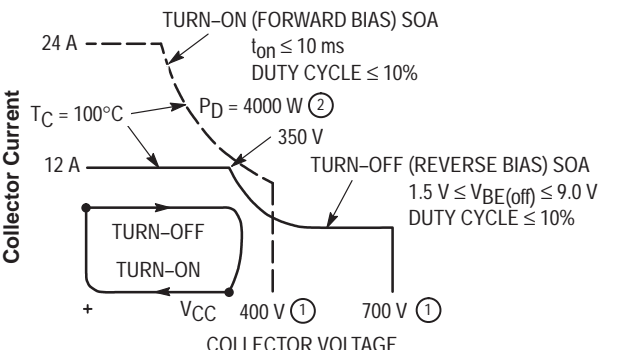
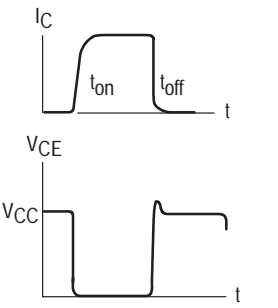
In resistive switching circuits, rise, fall, and storage times have been defined and apply to both current and voltage waveforms since they are in phase. However, for inductive loads which are common to SWITCHMODE power supplies and hammer drivers, current and voltage waveforms are not in phase. Therefore, separate measurements must be made on each waveform to determine the total switching time. For this reason, the following new terms have been defined.

t_{sv} = Voltage Storage Time, 90% I_{B1} to 10% V_{CEM}

t_{rv} = Voltage Rise Time, 10–90% V_{CEM}

t_{fi} = Current Fall Time, 90–10% I_{CM}

t_{tj} = Current Tail, 10–2% I_{CM}

t_c = Crossover Time, 10% V_{CEM} to 10% I_{CM}

An enlarged portion of the turn-off waveforms is shown in Figure 13 to aid in the visual identity of these terms.

For the designer, there is minimal switching loss during storage time and the predominant switching power losses occur during the crossover interval and can be obtained using the standard equation from AN-222:

$$P_{SWT} = 1/2 V_{CC} I_C (t_c) f$$

Typical inductive switching waveforms are shown in Figure 14. In general, t_{rv} + t_{fi} ≈ t_c. However, at lower test currents this relationship may not be valid.

As is common with most switching transistors, resistive switching is specified at 25°C and has become a benchmark for designers. However, for designers of high frequency converter circuits, the user oriented specifications which make this a "SWITCHMODE" transistor are the inductive switching speeds (t_c and t_{sv}) which are guaranteed at 100°C.

CASE 221D
Isolated TO-220 Type
UL Recognized
File #E69369

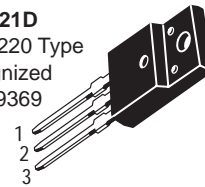

STYLE 1:
PIN 1. BASE
2. COLLECTOR
3. EMITTER

Table 1. Plastic (Isolated TO-220 Type)

I _C Cont Amps Max	V _{CEO(sus)} Volts Min	V _{CES} Volts Min	Device Type		h _{FE} Min/Max	@ I _C Amp	Resistive Switching			f _T MHz Min	P _D (Case) Watts @ 25°C
			NPN	PNP			t _s μs Max	t _f μs Max	@ I _C Amp		
1	250		MJF47		30/150	0.3	2 typ	0.17 typ	0.3	10	28
2	400	700	BUL44F		14/34	0.2	2.75 ⁽³⁾	0.2 ⁽³⁾	1	13 typ	25
		1000	MJF18002		14/34	0.2	2.75 ⁽³⁾	0.175 ⁽³⁾	1	13 typ	25
3	100		MJF31C	MJF32C	10 min	1	0.6	0.3	1	3	28
5	100		MJF122 ⁽²⁾	MJF127 ⁽²⁾	2000 min	3	1.5 typ	1.5 typ	3	4 ⁽¹⁾	28
	400	700	BUL45F		14/34	0.3	1.7 ⁽³⁾	0.15 ⁽³⁾	1	12 typ	35
	450	1000	BUT11AF		10 min	.005	4	0.8	2.5		40
		1000	MJF18004		14/34	0.3	1.7 ⁽³⁾	0.15 ⁽³⁾	1	13 typ	35
550	1200	MJF18204		18/35	0.5	2.75 ⁽³⁾	0.2 ⁽³⁾	2	12	35	
6	400	700	BUL146F		14/34	0.5	2.5 ⁽³⁾	0.15 ⁽³⁾	3	14 typ	40
	450	1000	MJF18006		14/34	0.5	3.2 ⁽³⁾	0.15 ⁽³⁾	3	14 typ	40
8	80			MJF6107	30/90	2	0.5 typ	0.13 typ	2	4	35
	150		MJF15030	MJF15031	40 min	3	1 typ	0.15 typ	3	30	35
	400	700	MJF13007		5/30	5	3	0.7	5	4	40
				BUL147F		14/34	1	2.5 ⁽³⁾	0.18 ⁽³⁾	2	14 typ
450	1000	MJF18008		16/34	1	2.75 ⁽³⁾	0.18 ⁽³⁾	2	13 typ	45	
10	60		MJF3055	MJF2955	20/100	4	—	—	—	2	40
	80		MJF44H11	MJF45H11	40/100	4	0.5 typ	0.14 typ	5	40	35
	100		MJF6388 ⁽²⁾	MJF6668 ⁽²⁾	3k/20k	3	1.5 typ	1.5 typ		20 ⁽¹⁾	40
	450	1000	MJF18009		14/34	1.5	2.75 ⁽³⁾	0.2 ⁽³⁾	3	12	50
12	400	700	MJF13009		6/30	8	3	0.7	8	8	40

(1)|h_{FE}| @ 1 MHz

(2)Darlington

(3)Switching tests performed w/special application simulator circuit. See data sheet for details.

Devices listed in bold, italic are Motorola preferred devices.

STYLE 1:
 PIN 1. BASE
 2. COLLECTOR
 3. EMITTER
 4. COLLECTOR

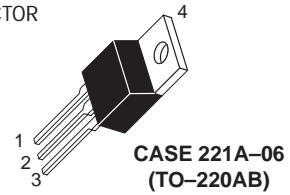

Table 2. Plastic TO-220AB

I _C Cont Amps Max	V _{CEO(sus)} Volts Min ⁽⁸⁾	Device Type		h _{FE} Min/Max	@ I _C Amp	Resistive Switching			f _T MHz Min	P _D (Case) Watts @ 25°C
		NPN	PNP			t _s μs Max	t _f μs Max	@ I _C Amp		
0.5	350	MJE2360T		15 min	0.1				10 typ	30
		MJE2361T		40 min	0.1				10 typ	30
1	100	TIP29C	TIP30C	15/75	1	0.6 typ	0.3 typ	1	3	30
	250	TIP47		30/150	0.3	2 typ	0.18 typ	0.3	10	40
	300	TIP48	MJE5730	30/150	0.3	2 typ	0.18 typ	0.3	10	40
	350	TIP49	MJE5731	30/150	0.3	2 typ	0.18 typ	0.3	10	40
	400	TIP50	MJE5731A⁽⁷⁾	30/150	0.3	2 typ	0.18 typ	0.3	10	40
2	100	TIP112⁽²⁾	TIP117⁽²⁾	500 min	2	1.7 typ	1.3 typ	2	25 ⁽¹⁾	50
	400/700	BUL44		14/36	0.4	2.75 ⁽³⁾	0.175 ⁽³⁾	1	13 typ	50
	450/1000	BUX85		30	0.1	3.5	1.4	1	4	50
	450/1000	MJE18002		14/34	0.2	3 ⁽³⁾	0.17 ⁽³⁾	1	12 typ	40
	900/1800	MJE1320		3 min	1	4 typ	0.8 typ	1		80
3	80	BD241B	BD242B	25 min	1				3	40
	100	BD241C	BD242C	25 min	1				3	40
		TIP31C	TIP32C	25 min	1	0.6 typ	0.3 typ	1	3	40
	150		MJE9780	50/200	0.5				5 typ	40

(1)|h_{FE}| @ 1 MHz
 (2)Darlington
 (3)Switching tests performed w/special application simulator circuit. See data sheet for details.
 (7)V_{CEO} = 375 V
 (8)When 2 voltages are given, the format is V_{CEO(sus)}/V_{CES}.

Devices listed in bold, italic are Motorola preferred devices.

Table 2. Plastic TO-220AB (continued)

I _C Cont Amps Max	V _{CEO(sus)} Volts Min ⁽⁸⁾	Device Type		h _{FE} Min/Max	@ I _C Amp	Resistive Switching			f _T MHz Min	P _D (Case) Watts @ 25°C
		NPN	PNP			t _s μs Max	t _f μs Max	@ I _C Amp		
4	40		MJE1123	45/100	4				5	75
	60	MJE800 ⁽²⁾	MJE700 ⁽²⁾	750 min	1.5				1 ⁽¹⁾	40
	80	D44C12	D45C12	40/120	0.2			1	40 typ	30
	400/700	MJE13005		6/30	3	3	0.7	3	4	60
5	100	TIP122 ⁽²⁾	TIP127 ⁽²⁾	1k min	3	1.5 typ	1.5 typ	4	4 ⁽¹⁾	75
	250	2N6497		10/75	2.5	1.8	0.8	2.5	5	80
	300	2N6498		10/75	2.5	1.8	0.8	2.5	5	80
	400/700	BUL45		14/34	0.3	1.7 ⁽³⁾	0.15 ⁽³⁾	1	12 typ	75
	450/1000	MJE16002		5 min	5	3	0.3	3		80
	450/850	MJE16004		7 min	5	2.7	0.35	3		80
	450/1000	MJE18004		14/34	0.3	1.7	0.15	1.0	13	75
	550/1200	MJE18204		18/35	0.5	2.75 ⁽³⁾	0.2 ⁽³⁾	2	12	75
6	80	BD243B	BD244B	15 min	3	0.4 typ	0.15 typ	3	3	65
	100	BD243C	BD244C	15 min	3	0.4 typ	0.15 typ	3	3	65
		TIP41C	TIP42C	15/75	3	0.4 typ	0.15 typ	3	3	65
	250/550	MJE16204		5 min	6	1.5 ⁽²⁾	0.15 ⁽²⁾	1	10	80
	400/700	BUL146		14/34	0.5	1.75 ⁽³⁾	0.15 ⁽³⁾	3	14 typ	100
	450/1000	MJE18006		14/34	0.5	3.2 ⁽³⁾	0.13 ⁽³⁾	3	14 typ	100
7	30	2N6288	2N6111	30/150	3	0.4 typ	0.15 typ	3	4	40
	50		2N6109	30/150	2.5	0.4 typ	0.15 typ	3	4	40
	70	2N6292	2N6107	30/150	2	0.4 typ	0.15 typ	3	4	40
	100	BD801	BD802	15 min	3				3	65
	150	BU407		30 min	1.5		0.75	5	10	60
	200	BU406		30 min	1.5		0.75	5	10	60
	450	BU522B ⁽²⁾		250 min	2.5				7.5	75

(1)|h_{FE}| @ 1 MHz

(2)Darlington

(3)Switching tests performed w/special application simulator circuit. See data sheet for details.

(7)V_{CEO} = 375 V

(8)When 2 voltages are given, the format is V_{CEO(sus)}/V_{CES}.

Table 2. Plastic TO-220AB (continued)

I _C Cont Amps Max	V _{CEO(sus)} Volts Min ⁽⁸⁾	Device Type		h _{FE} Min/Max	@ I _C Amp	Resistive Switching			f _T MHz Min	P _D (Case) Watts @ 25°C
		NPN	PNP			t _s μs Max	t _f μs Max	@ I _C Amp		
8	60	2N6043 ⁽²⁾	2N6040 ⁽²⁾	1k/10k	4	1.5 typ	1.5 typ	3	4 ⁽¹⁾	75
	80	2N6044 ⁽²⁾	2N6041 ⁽²⁾	1k/10k	4	1.5 typ	1.5 typ	3	4 ⁽¹⁾	75
		BDX53B ⁽²⁾	BDX54B ⁽²⁾	750 min	3				4 ⁽¹⁾	60
	100	2N6045 ⁽²⁾	2N6042 ⁽²⁾	1k/10k	3	1.5 typ	1.5 typ	3	4 ⁽¹⁾	75
		BDX53C ⁽²⁾	BDX54C ⁽²⁾	750 min	3					
		TIP102 ⁽²⁾	TIP107 ⁽²⁾	1k/20k	3	1.5 typ	1.5 typ	3	4 ⁽¹⁾	80
	120	MJE15028	MJE15029	20 min	4				30	50
	150	MJE15030	MJE15031	20 min	4				30	50
	200	BU806 ⁽²⁾		100 min	5	0.55 typ	0.2 typ	5		60
	300/600	MJE5740 ⁽²⁾		200 min	4	8 typ	2 typ	6	4	80
			MJE5850	15 min	2	2	0.5	4		80
	350	MJE5741 ⁽²⁾		200 min	4	8 typ	2 typ	6		80
			MJE5851	15 min	2	2	0.5	4		80
		MJE5742 ⁽²⁾		200 min	4	8 typ	2 typ	6		80
		MJE13007		5/30	5	3	0.7	5		80
			MJE5852	15 min	2	2	0.5	4		80
400/650	MJE16106		6/22	8	2 typ	0.1 typ	5		100	
400/700	BUL147		14/34	1	2.5 ⁽³⁾	0.18 ⁽³⁾	2	14 typ	125	
450/1000	MJE18008		16/34	1	2.75 ⁽³⁾	0.18 ⁽³⁾	2	13 typ	125	
10	20		BD808	15 min	4				1.5	90
	60	D44H8	D45H8	40 min	4					50
		MJE3055T	MJE2955T	20/70	4					75
		2N6387 ⁽²⁾	2N6667 ⁽²⁾	1k/20k	5				20 ⁽¹⁾	65
	80	BDX33B ⁽²⁾	BDX34B ⁽²⁾	750 min	3				3	70
		BD809	BD810	15 min	4				1.5	90
		2N6388 ⁽²⁾	2N6668 ⁽²⁾	1k/20k	5				20 ⁽¹⁾	65
		D44H10	D45H10	20 min	4	0.5 typ	0.14 typ	5	50 typ	50
D44H11		D45H11	40 min	4	0.5 typ	0.14 typ	5	50 typ	50	

(1)h_{FE} @ 1 MHz
 (2)Darlington
 (3)Switching tests performed w/special application simulator circuit. See data sheet for details.
 (7)V_{CEO} = 375 V
 (8)When 2 voltages are given, the format is V_{CEO(sus)}/V_{CES}.
 (9)Self protected Darlington

Devices listed in bold, italic are Motorola preferred devices.

Table 2. Plastic TO-220AB (continued)

I _C Cont Amps Max	V _{CEO(sus)} Volts Min(8)	Device Type		h _{FE} Min/Max	@ I _C Amp	Resistive Switching			f _T MHz Min	P _D (Case) Watts @ 25°C
		NPN	PNP			t _s μs Max	t _f μs Max	@ I _C Amp		
10	100	<i>BDX33C</i> (2)	<i>BDX34C</i> (2)	750 min	3				3	70
	450/1000	<i>MJE18009</i>		14/34	1.5	2.75(3)	0.2(3)	3	12	150
12	400/700	<i>MJE13009</i>		6/30	8	3	0.7	8	4	100
15	80	<i>2N6488</i>	<i>2N6491</i>	20/150	5	0.6 typ	0.3 typ	5	5	75
		<i>D44VH10</i>	<i>D45VH10</i>	20 min	4	0.5	0.09	8	50 typ	83
	100	<i>BDW42</i> (2)	<i>BDW47</i> (2)	1k min	5	1 typ	1.5 typ	5	4	85

STYLE 1:
PIN 1. BASE
2. COLLECTOR
3. EMITTER
4. COLLECTOR

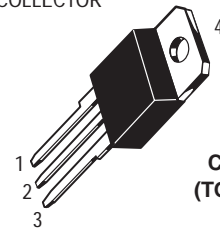

CASE 340D
(TO-218 Type,
SOT-93)

Table 3. Plastic TO-218 Type

I _C Cont Amps Max	V _{CEO(sus)} Volts Min(8)	Device Type		h _{FE} Min/Max	@ I _C Amp	Resistive Switching			f _T MHz Min	P _D (Case) Watts @ 25°C
		NPN	PNP			t _s μs Max	t _f μs Max	@ I _C Amp		
8	500/1000	<i>MJH16006A</i>		5 min	8	2.5	0.25	5		125
10	60	TIP140(2)	TIP145(2)	500 min	10	2.5 typ	2.5 typ	5	4(1)	125
		TIP141(2)	TIP146(2)	500 min	10	2.5 typ	2.5 typ	5	4(1)	125
	100	<i>BDV65B</i> (2)	<i>BDV64B</i> (2)	1k min	5					125
		TIP33C	TIP34C	20/100	3				3	80
		<i>TIP142</i> (2)	<i>TIP147</i> (2)	500 min	10	2.5 typ	2.5 typ	5	4(1)	125
	400	<i>BU323AP</i> (2)		150/100	6	15	15	6		125
<i>MJH10012</i> (2)			100/2k	6	15	15	6		118	

(1)|h_{FE}| @ 1 MHz

(2)Darlington

(8)When 2 voltages are given, the format is V_{CEO(sus)}/V_{CES}.

Table 3. Plastic TO-218 Type (continued)

I _C Cont Amps Max	V _{CEO(sus)} Volts Min ⁽⁸⁾	Device Type		h _{FE} Min/Max	@ I _C Amp	Resistive Switching			f _T MHz Min	P _D (Case) Watts @ 25°C
		NPN	PNP			t _s μs Max	t _f μs Max	@ I _C Amp		
15	60	TIP3055	TIP2955	5 min	10				2.5	80
	150	MJH11018 ⁽²⁾	MJH11017 ⁽²⁾	400/15k	10				3	150
	200	MJH11020 ⁽²⁾	MJH11019 ⁽²⁾	400/15k	10				3	150
	250	MJH11022⁽²⁾	MJH11021⁽²⁾	400/15k	10				3	150
	400	BUV48		8 min	10	2	0.4	10		150
	450	BUV48A		8 min	8	2	0.4	10		150
16	140	MJE4342	MJE4352	15 min	8	1.2 typ	1.2 typ	8	1	125
	160	MJE4343	MJE4353	15 min	8	1.2 typ	1.2 typ	8	1	125
20	60	MJH6282 ⁽²⁾	MJH6285 ⁽²⁾	750/18k	10				4	125
	100	MJH6284⁽²⁾	MJH6287⁽²⁾	750/18k	10				4	125
25	80	TIP35A	TIP36A	15/75	15	0.6 typ	0.3 typ	10	3	125
	100	BD249C	BD250C	10 min	15				3	125
		TIP35C	TIP36C	15/75	15	0.6 typ	0.3 typ	10	3	125

⁽²⁾Darlington

⁽⁸⁾When 2 voltages are given, the format is V_{CEO(sus)}/V_{CES}.

STYLE 2:
PIN 1. BASE
2. COLLECTOR
3. EMITTER

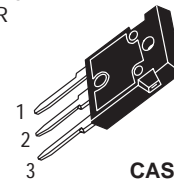

CASE 340F
(TO-247 Type)

Table 4. Isolated Mounting Hole — Plastic TO-247 Type

I _C Cont Amps Max	V _{CEO(sus)} Volts Min	V _{CES} Volts Min	Device Type		h _{FE} Min/Max	@ I _C Amp	Resistive Switching			f _T MHz Min	P _D (Case) Watts @ 25°C
			NPN	PNP			t _s μs Max	t _f μs Max	@ I _C Amp		
10	650	1500	MJW16212		4/10	10	4 ⁽³⁾	0.5 ⁽³⁾	5.5		150
	800	1500	MJW16018		4 min	5	4.5 typ	0.2 typ	5	3 typ	150
12	500	1200	MJW16206		5/13	10	2.25	0.25	6.5	3 typ	150
15	450	850	MJW16010		5 min	15	1.2 typ	0.2 typ	10		150
		850	MJW16012		7 min	15	0.9 typ	0.15 typ	10		150
	500	1000	MJW16010A		5 min	15	3	0.4	10		150

⁽³⁾Switching tests performed w/special application simulator circuit. See data sheet for details.

⁽¹⁰⁾Tested in Applications simulator: see Data Sheet.

Devices listed in bold, italic are Motorola preferred devices.

New Product New Product New Product New Product

STYLE 2:
PIN 1. BASE
2. COLLECTOR
3. EMITTER

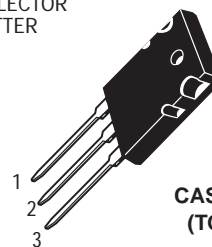

CASE 340G
(TO-264)

Table 5. Large Plastic TO-264

I _C Cont Amps Max	V _{CEO(sus)} Volts Min	Device Type		hFE Min/Max	@ I _C Amp	Resistive Switching			f _T MHz Min	P _D (Case) Watts @ 25°C
		NPN	PNP			t _s μs Max	t _f μs Max	@ I _C Amp		
15	200	<i>MJL3281A</i>	<i>MJL1302A</i>	60/175	0.1				30 typ	200
	650/1500	<i>MJL16218</i>		4/11	12				2.5 typ	170
16	250	<i>MJL21194</i>	<i>MJL21193</i>	25/75	8				4	200

New Product New Product New Product New Product

STYLE 1:
PIN 1. EMITTER
2. COLLECTOR
3. BASE

STYLE 3:
PIN 1. BASE
2. COLLECTOR
3. EMITTER

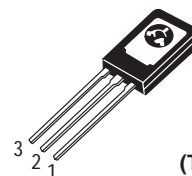

CASE 77
(TO-225AA)

Table 6. Plastic TO-225AA Type (Formerly TO-126 Type)

I _C Cont Amps Max	V _{CEO(sus)} Volts Min	Device Type		hFE Min/Max	@ I _C Amp	Resistive Switching			f _T MHz Min	P _D (Case) Watts @ 25°C
		NPN	PNP			t _s μs Max	t _f μs Max	@ I _C Amp		
0.3	350	<i>MJE3439</i>		40/160	0.02				15	15
0.5	150	MJE341		25/200	0.05				15	20.8
	200	<i>MJE344</i>		30/300	0.05				15	20.8
	250	2N5655		30/250	0.1	3.5 typ	0.24 typ	0.1	10	20
		BD157		30/240	0.05					20
	300	<i>BD158</i>		30/240	0.05					20
		<i>MJE340</i>	<i>MJE350</i>	30/240	0.05					20.8
2N5656			30/250	0.1	3.5 typ	0.24 typ	0.1	10	20	

Devices listed in bold, italic are Motorola preferred devices.

Table 6. Plastic TO-225AA Type (Formerly TO-126 Type) (continued)

I _C Cont Amps Max	V _{CEO(sus)} Volts Min	Device Type		h _{FE} Min/Max	@ I _C Amp	Resistive Switching			f _T MHz Min	P _D (Case) Watts @ 25°C
		NPN	PNP			t _s μs Max	t _f μs Max	@ I _C Amp		
0.5	350	2N5657		30/250	0.1	3.5 typ	0.24 typ	0.1	10	20
		BD159		30/240	0.05					20
1	40	2N4921	2N4918	20/100	0.5	0.6 typ	0.3 typ	0.5	3	30
	60	2N4922	2N4919	20/100	0.5	0.6 typ	0.3 typ	0.5	3	30
	80	2N4923	2N4920	20/100	0.5	0.6 typ	0.3 typ	0.5	3	30
1.5	45	BD165	BD166	15 min	0.5				6	20
		BD135	BD136	40/250	0.15					12.5
	60	BD137	BD138	40/250	0.15					12.5
	80	BD169		15 min	0.5				6	20
		BD139	BD140	40/250	0.15					12.5
			BD140-10	63/160	0.15					12.5
	300	MJE13002 ⁽¹¹⁾		5/25	1	4	0.7	1	5	40
	400	MJE13003 ⁽¹¹⁾		5/25	1	4	0.7	1	5	40
2	80	BD237	BD238	25 min	1				3	25
	100	MJE270 ⁽²⁾⁽¹¹⁾	MJE271 ⁽²⁾⁽¹¹⁾	1.5k min	0.12				6	15
3	60	MJE181	MJE171	50/250	0.1	0.6 typ	0.12 typ	0.1	50	12.5
	80	BD179	BD180	40/250	0.15				3	30
		MJE182	MJE172	50/250	0.1	0.6 typ	0.12 typ	0.1	50	12.5
	200	BUY49P		30 min	0.5				25	20
4	40	MJE521	MJE371	40 min	1					40
	45	BD437	BD438	40 min	2				3	36
			BD776 ⁽²⁾	750 min	2				20	15
	60		BD440	25 min	2				3	36
		BD677 ⁽²⁾	BD678 ⁽²⁾	750 min	1.5					40
		BD677A ⁽²⁾	BD678A ⁽²⁾	750 min	2					40
		BD787	BD788	20 min	2				50	15
		BD777 ⁽²⁾	BD778 ⁽²⁾	750 min	2				20	15
		2N5191	2N5194	25/100	1.5	0.4 typ	0.4 typ	1.5	2	40
		MJE800 ⁽²⁾	MJE700 ⁽²⁾	750 min	1.5				1 ⁽¹⁾	40
		2N6038 ⁽²⁾	2N6035 ⁽²⁾	750/18k	2	1.7 typ	1.2 typ	2	25	40
	80	2N5192	2N5195	25/100	1.5	0.4 typ	0.4 typ	1.5	2	40
		BD441	BD442	15 min	2				3	36
		BD679 ⁽²⁾	BD680 ⁽²⁾	750 min	1.5					40
BD679A ⁽²⁾		BD680A ⁽²⁾	750 min	2					40	
BD789		BD790	10 min	2				40	15	

(1) |h_{FE}| @ 1 MHz

(2) Darlington

(11) Case 77, Style 3

Devices listed in bold, italic are Motorola preferred devices.

Table 6. Plastic TO–225AA Type (Formerly TO–126 Type) (continued)

I _C Cont Amps Max	V _{CEO(sus)} Volts Min	Device Type		h _{FE} Min/Max	@ I _C Amp	Resistive Switching			f _T MHz Min	P _D (Case) Watts @ 25°C
		NPN	PNP			t _s μs Max	t _f μs Max	@ I _C Amp		
4	80	<i>BD779</i> (2)	<i>BD780</i> (2)	750 min	2				20	15
		MJE802(2)	MJE702(2)	750 min	1.5				1(1)	40
		<i>MJE803</i> (2)	<i>MJE703</i> (2)	750 min	2				1(1)	40
		<i>2N6039</i> (2)	<i>2N6036</i> (2)	750/18k	2	1.7 typ	1.2 typ	2	25	40
	100	<i>BD681</i> (2)	<i>BD682</i> (2)	750 min	1.5					40
		<i>BD791</i>	<i>BD792</i>	10 min	2				40	15
<i>MJE243</i>		<i>MJE253</i>	40/120	0.2	0.15 typ	0.07 typ	2	40	15	
5	25	<i>MJE200</i>	<i>MJE210</i>	45/180	2	0.13 typ	0.035 typ	2	65	15



STYLE 1:
PIN 1. BASE
2. COLLECTOR
3. EMITTER
4. COLLECTOR

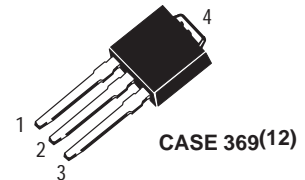

Table 7. DPAK – Surface Mount Power Packages

I _C Cont Amps Max	V _{CEO(sus)} Volts Min	Device Type		h _{FE} Min/Max	@ I _C Amp	Resistive Switching			f _T MHz Min	P _D (Case) Watts @ 25°C
		NPN	PNP			t _s μs Max	t _f μs Max	@ I _C Amp		
0.5	300	<i>MJD340</i>	<i>MJD350</i>	30/240	0.05					15
1	250	MJD47		30/150	0.3	2	0.2	0.3	10	15
	375		<i>MJD5731</i>	TBD	TBD	TBD	TBD	TBD	TBD	TBD
	400	<i>MJD50</i>		30/150	0.3	2	0.2	0.3	10	15
1.5	400	<i>MJD13003</i>		5/25	1	4	0.7	1	4	15

(1)|h_{FE}| @ 1 MHz

(2)Darlington

(12)Case 369–07 may be ordered by adding –1 suffix to part number.

(13)Case 369A–13 may be ordered as tape and reel by adding a “T4” suffix; 2500 units/reel.

Devices listed in bold, italic are Motorola preferred devices.

Table 7. DPAK – Surface Mount Power Packages (continued)

I _C Cont Amps Max	V _{CEO(sus)} Volts Min	Device Type		h _{FE} Min/Max	@ I _C Amp	Resistive Switching			f _T MHz Min	P _D (Case) Watts @ 25°C
		NPN	PNP			t _s μs Max	t _f μs Max	@ I _C Amp		
2	100	<i>MJD112</i> (2)	<i>MJD117</i> (2)	1000 min	2	1.7	1.3	2	25(1)	20
3	40	MJD31	MJD32	10 min	1	0.6	0.3	1	3	15
	100	<i>MJD31C</i>	<i>MJD32C</i>	10 min	1	0.6	0.3	1	3	15
4	80	<i>MJD6039</i> (2)	<i>MJD6036</i> (2)	1k/12k	2	1.7	1.2	2	25	20
	100	<i>MJD243</i>	<i>MJD253</i>	40/180	0.2	0.16	0.04	1	40	12.5
5	25	<i>MJD200</i>	<i>MJD210</i>	45/180	2	0.15	0.04	2	65	12.5
6	100	<i>MJD41C</i>	<i>MJD42C</i>	15/75	3	0.4	0.15	3	3	20
8	80	<i>MJD44H11</i>	<i>MJD45H11</i>	40 min	4	0.5	0.14	5	50 typ	20
	100	<i>MJD122</i> (2)	<i>MJD127</i> (2)	1k/12k	4	1.5	2	4	4(1)	20
10	60	<i>MJD3055</i>	<i>MJD2955</i>	20/100	4	1.5	1.5	3	2	20
	80	<i>MJD44E3</i> (2)		1k min	5	2	0.5	10		20

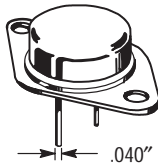

CASE 1-07
TO-204AA

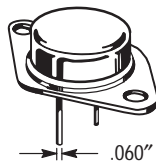

CASE 197A TO-204AE
(Used for high current types at end of
table. See types w/footnote(16).)

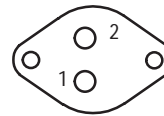

STYLE 1:
PIN 1. BASE
2. EMITTER
3. COLLECTOR

Table 8. Metal TO-204AA (Formerly TO-3), TO-204AE

I _C Cont Amps Max	V _{CEO(sus)} Volts Min(8)	Device Type		h _{FE} Min/Max	@ I _C Amp	Resistive Switching			f _T MHz Min	P _D (Case) Watts @ 25°C
		NPN	PNP			t _s μs Max	t _f μs Max	@ I _C Amp		
4	200	MJ15018		30 min	1				20	150
	250	<i>MJ15020</i>	<i>MJ15021</i>	30 min	1				20	150
5	700/1500	<i>BU208A</i>		2.5 min	4.5	8 typ	0.4 typ	4.5	4 typ	90
8	60	MJ1000(2)		1k min	3					90
		2N6055(2)		750/18k	4	1.5 typ	1.5 typ	4	4(1)	100
	80	<i>MJ1001</i> (2)		1k min	3					90
		<i>2N6056</i> (2)		750/18k	4	1.5 typ	1.5 typ	4	4(1)	100

(1)|h_{FE}| @ 1 MHz

(2)Darlington

(8)When 2 voltages are given, the format is V_{CEO(sus)}/V_{CES}

(12)Case 369 may be ordered by adding -1 suffix to part number.

(13)Case 369A may be ordered as tape and reel by adding a "T4" suffix; 2500 units/reel.

Devices listed in bold, italic are Motorola preferred devices.

Table 8. Metal TO–204AA (Formerly TO–3), TO–204AE (continued)

I _C Cont Amps Max	V _{CEO(sus)} Volts Min ⁽⁸⁾	Device Type		h _{FE} Min/Max	@ I _C Amp	Resistive Switching			f _T MHz Min	P _D (Case) Watts @ 25°C
		NPN	PNP			t _s μs Max	t _f μs Max	@ I _C Amp		
10	60	2N3715	2N3791	30 min	3	0.3 typ	0.4 typ	5	4	150
		MJ3000 ⁽²⁾	MJ2500 ⁽²⁾	1k min	5					150
	80	2N3716	2N3792	30 min	3	0.3 typ	0.4 typ	5	4	150
		2N5878		20/100	4	1	0.8	4	4	150
		MJ3001 ⁽²⁾	MJ2501⁽²⁾	1k min	5					150
	140	2N3442		20/70	4					117
	250	MJ15011	MJ15012	20/100	2					200
	325	MJ413		20/80	0.5				2.5	125
		MJ423		30/90	1				2.5	125
	400	BU323A⁽²⁾		150 min	6	7.5 typ	5.2 typ	6		175
MJ10007⁽²⁾			30/300	5	1.5	0.5	5	10 ⁽¹⁾	150	
MJ10012⁽²⁾			100/2k	6	15	15	6		175	
12	60	2N6057 ⁽²⁾	2N6050 ⁽²⁾	750/18k	6	1.6 typ	1.5 typ	6	4 ⁽¹⁾	150
	80	2N6058 ⁽²⁾	2N6051 ⁽²⁾	750/18k	6	1.6 typ	1.5 typ	6	4 ⁽¹⁾	150
	100	2N6059⁽²⁾	2N6052⁽²⁾	750/18k	6	1.6 typ	1.5 typ	6	4 ⁽¹⁾	150
15	60	2N3055	MJ2955	20/70	4	0.7 typ	0.3 typ	4	2.5	115
		2N3055A	MJ2955A	20/70	4				0.8	115
		2N6576 ⁽²⁾		2k/20k	4	2	7	10	10–200 ⁽¹⁾	120
		2N5881	2N5879	20/100	6	1	0.8	6	4	160
	80	2N5882	2N5880	20/100	6	1	0.8	6	4	160
	90	2N6577 ⁽²⁾		2k/20k	4	2	7	10	10–200 ⁽¹⁾	120
	120	MJ15015	MJ15016	20/70	4	0.7 typ	0.3 typ	4	1	180
		2N6578⁽²⁾		2k/20k	4	2	7	10	10–200 ⁽¹⁾	120
	140	MJ15001	MJ15002	25/150	4				2	200
	150	MJ11018 ⁽²⁾	MJ11017 ⁽²⁾	100 min	15				3 ⁽¹⁾	175
	200	MJ11020 ⁽²⁾		100 min	15				3 ⁽¹⁾	175
		MJ3281A	MJ1302A	60/175	0.1				30 typ	250
	250	MJ11022⁽²⁾	MJ11019 ⁽²⁾	100 min	15				3 ⁽¹⁾	175
			MJ11021⁽²⁾	6/30	10	4	0.7	10	6 to 24	175
	400/850	BUX48		8 min	10	2	0.4	10		175
		2N6547		6/30	10	4	0.7	10	6 to 24	175
	400/650	MJ16110		6/20	15	0.8 typ	0.1 typ	10		175
450/1000	BUX48A		8 min	8	2	0.4	10		175	

(1)|h_{FE}| @ 1 MHz

(2)Darlington

(8)When 2 voltages are given, the format is V_{CEO(sus)}/V_{CES}.

Devices listed in bold, italic are Motorola preferred devices.

Table 8. Metal TO–204AA (Formerly TO–3), TO–204AE (continued)

I _C Cont Amps Max	V _{CEO(sus)} Volts Min ⁽⁸⁾	Device Type		h _{FE} Min/Max	@ I _C Amp	Resistive Switching			f _T MHz Min	P _D (Case) Watts @ 25°C
		NPN	PNP			t _s μs Max	t _f μs Max	@ I _C Amp		
15	450/850	MJ16010		5 min	15	1.2 typ	0.2 typ	10		175
		MJ16012		7 min	15	0.9 typ	0.15 typ	10		175
16	140	2N3773	2N6609	15/60	8	1.1 typ	1.5 typ	8	4	150
		2N5631	2N6031	15/60	8	1.2 typ	1.2 typ	8	1	200
	200	MJ15022	MJ15023	15/60	8				5	250
	250	MJ15024	MJ15025	15/60	8				5	250
		MJ21194	MJ21193	25/75	8				4	250
	20	60	2N3772		15/60	10				2
2N6282 ⁽²⁾			2N6285 ⁽²⁾	750/18k	10	2.5 typ	2.5 typ	10	4 ⁽¹⁾	160
75		2N5039		20/100	10	1.5	0.5	10	60	140
80		2N6283 ⁽²⁾	2N6286 ⁽²⁾	750/18k	10	2.5 typ	2.5 typ	10	4 ⁽¹⁾	160
90		2N5038		20/100	12	1.5	0.5	12	60	140
100		2N6284 ⁽²⁾	2N6287 ⁽²⁾	750/18k	10	2.5 typ	2.5 typ	10	4 ⁽¹⁾	160
140		MJ15003	MJ15004	25/150	5				2	250
200		BUV11		10 min	12	1.8	0.4	12	8	150
350		MJ10000 ⁽²⁾		40/400	10	3	1.8	10	10 ⁽¹⁾	175
400		MJ10005 ⁽²⁾		40/400	10	1.5	0.5	10	10 ⁽¹⁾	175
		MJ13333		10/60	5	4	0.7	10		175
500		MJ10009 ⁽²⁾		30/300	10	2	0.6	10	8 ⁽¹⁾	175
25		60	2N5885	2N5883	20/100	10	1	0.8	10	4
	80	2N5886	2N5884	20/100	10	1	0.8	10	4	200
			2N6436	30/120	10	1	0.25	10	40	200
	100	2N6338	2N6437	30/120	10	1	0.25	10	40	200
	120	2N6339	2N6438	30/120	10	1	0.25	10	40	200
	140	2N6340		30/120	10	1	0.25	10	40	200
150	2N6341		30/120	10	1	0.25	10	40	200	
30	40	2N3771		15/60	15				2	150
		2N5301	2N4398	15/60	15	2	1	10	2	200
	60	2N5302	2N4399	15/60	15	2	1	10	2	200
		MJ11012 ⁽²⁾	MJ11011 ⁽²⁾	1k min	20				4 ⁽¹⁾	200
	90	MJ11014 ⁽²⁾	MJ11013 ⁽²⁾	1k min	20				4 ⁽¹⁾	200
	100	2N6328		6/30	30				3	200
		MJ802	MJ4502	25/100	7.5				2	200
	120	MJ11016 ⁽²⁾	MJ11015 ⁽²⁾	1k min	20				4 ⁽¹⁾	200

(1) |h_{FE}| @ 1 MHz

(2) Darlington

(8) When 2 voltages are given, the format is V_{CEO(sus)}/V_{CES}.

Devices listed in bold, italic are Motorola preferred devices.

Table 8. Metal TO–204AA (Formerly TO–3), TO–204AE (continued)

I _C Cont Amps Max	V _{CEO(sus)} Volts Min ⁽⁸⁾	Device Type		h _{FE} Min/Max	@ I _C Amp	Resistive Switching			f _T MHz Min	P _D (Case) Watts @ 25°C
		NPN	PNP			t _s μs Max	t _f μs Max	@ I _C Amp		
30	325	BUV23		8 min	16	1.8	0.4	16	8	250
	400/1000	BUS98		8 min	20	2.3	0.4	20		250
		BUX98		8 min	20	3	0.8	20		250
	450/850	MJ16020 ⁽¹⁶⁾		5 min	30	1.8	0.2	20		250
		MJ16022 ⁽¹⁶⁾		7 min	30	1.5	0.15	20		250
	450/1000	BUS98A		8 min	16	2.3	0.4	16		250
		BUX98A		8 min	16	3	0.8	16		250
40	200	BUV21 ⁽¹⁶⁾		10 min	25	1.8	0.4	25	8	150
	250	BUV22 ⁽¹⁶⁾		10 min	20	1.1	0.35	20	8	250
	350	MJ10022 ⁽²⁾ ⁽¹⁶⁾		50/600	10	2.5	0.9	20		250
	400	MJ10023 ⁽²⁾ ⁽¹⁶⁾		50/600	10	2.5	0.9	20		250
50	60	2N5685 ⁽¹⁶⁾		15/60	25	0.5 typ	0.3 typ	25	2	300
	80	2N5686 ⁽¹⁶⁾	2N5684 ⁽¹⁶⁾	15/60	25	0.5 typ	0.3 typ	25	2	300
	90	MJ11030 ⁽²⁾ ⁽¹⁶⁾	MJ11031 ⁽²⁾ ⁽¹⁶⁾	400 min	50					300
	100	2N6274 ⁽¹⁶⁾		30/120	20	0.8	0.25	20	30	250
	120	2N6275 ⁽¹⁶⁾	2N6379 ⁽¹⁶⁾	30/120	20	0.8	0.25	20	30	250
		MJ11032 ⁽²⁾ ⁽¹⁶⁾	MJ11033 ⁽²⁾ ⁽¹⁶⁾	400 min	50					300
	125	BUV20 ⁽¹⁶⁾		10 min	50	1.2	0.25	50	8	250
		BUV60 ⁽¹⁶⁾		10 min	80	1.1	0.25	80		250
	150	2N6277 ⁽¹⁶⁾		30/120	20	0.8	0.25	20	30	250
	400	MJ10015 ⁽²⁾ ⁽¹⁶⁾		10 min	40	2.5	1	20		250
	500	BUT34 ⁽²⁾ ⁽¹⁶⁾		15 min	32	3	1.5	32		250
MJ10016 ⁽²⁾ ⁽¹⁶⁾			10 min	40	2.5	1	20		250	
56	400	BUT33 ⁽²⁾ ⁽¹⁶⁾		20 min	36	3.3	1.6	36		250
60	60		MJ14001 ⁽¹⁶⁾	15/100	50					300
	80	MJ14002 ⁽¹⁶⁾	MJ14003 ⁽¹⁶⁾	15/100	50					300
	200	MJ10020 ⁽²⁾ ⁽¹⁶⁾		75 min	15	3.5	0.5	30		250
	250	MJ10021 ⁽²⁾ ⁽¹⁶⁾		75 min	15	3.5	0.5	30		250
70	125	BUS50 ⁽¹⁶⁾		15 min	50	1.5	0.3	70		350
80	100	BUV18A ⁽¹⁶⁾		10 min	80	1.1	0.25	80		250

(1) |h_{FE}| @ 1 MHz

(2) Darlington

(8) When 2 voltages are given, the format is V_{CEO(sus)}/V_{CES}.

(16) Case 197A–03 (TO–204AE)

Devices listed in bold, italic are Motorola preferred devices.

Audio

GENERAL DESIGN CURVES FOR POWER AUDIO OUTPUT STAGES

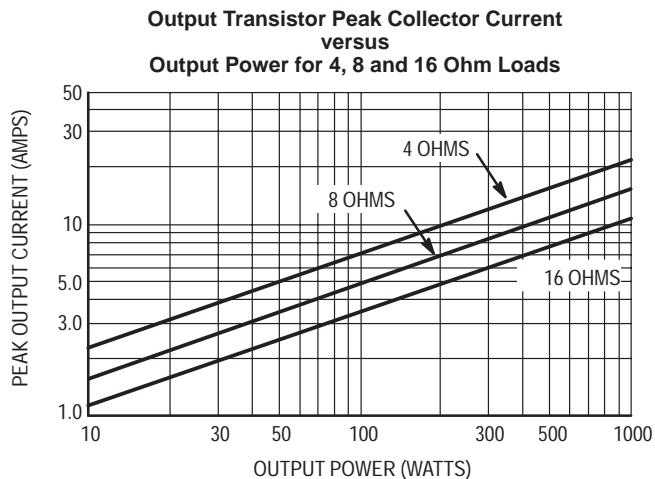
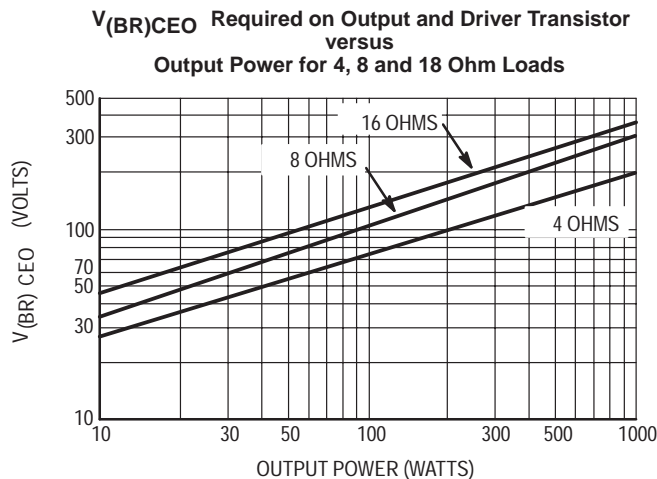

Another important parameter that must be considered before selecting the output transistors is the safe-operating area these devices must withstand. For a complete discussion see Application Note AN485.

Table 9. Recommended Power Transistors for Audio/Servo Loads

RMS Power Output	NPN	PNP	Case	P_D Watts @ 25°C	V_{CEO}	h_{FE} @ Min/Max	I_C Amps	f_T MHz Typ	ISB Volts/Amps
To 25W	MJE15030	MJE15031	TO-220	50	150	20 min	4	30	14/3.6
	MJE15032	MJE15033	TO-220	50	250	50 min	1	40	50/1
25 to 50W	2N3055A	MJ2955A	TO-204	120	120	20/70	4	3	60/2
	MJ15001	MJ15002	TO-204	200	140	25/150	4	3	40/5
50 to 100W	MJ15015	MJ15016	TO-204	180	120	20/70	4	3	60/3
	MJ15003	MJ15004	TO-204	250	140	25/150	5	3	100/1
	MJ15020	MJ15021	TO-204	150	250	30 min	1	20	50/3
Over 100W	MJ15024	MJ15025	TO-204	250	250	15/60	8	8	80/2.2
	MJ3281A	MJ1302A	TO-204	250	200	60/175	7	30	50/4
	MJL3281A	MJL1302A	340G-01	150	200	60/175	7	30	40/4
	MJ21194	MJ21193	TO-204	250	250	25/75	8	7	100/2
	MJL21194	MJL21193	340G-01	200	200	25/75	8	7	100/2

The Power Transistors shown are provided for reference only and show device capability. The final choice of the Power Transistors used is left to the circuit designer and depends upon the particular safe-operating area required and the mounting and heat sinking configuration used.

INFORMATION FOR USING SURFACE MOUNT PACKAGES

RECOMMENDED FOOTPRINTS FOR SURFACE MOUNTED APPLICATIONS

Surface mount board layout is a critical portion of the total design. The footprint for the semiconductor packages must be the correct size to ensure proper solder connection interface between the board and the package. With the correct

pad geometry, the packages will self align when subjected to a solder reflow process.

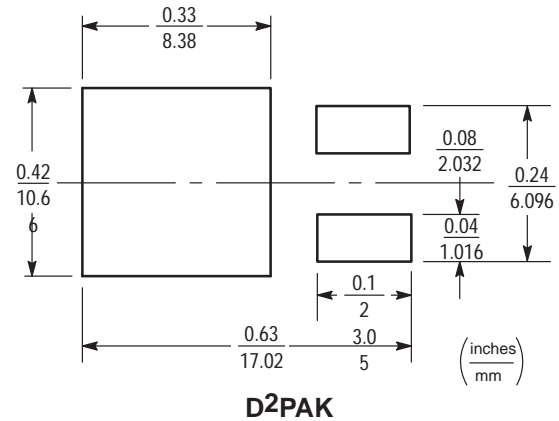
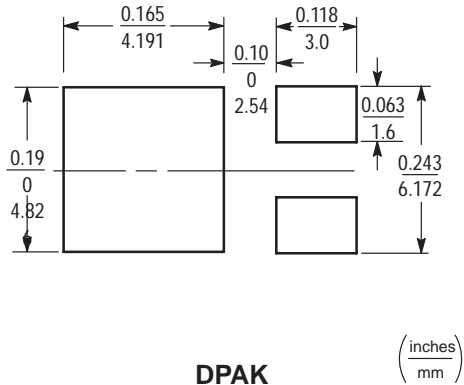

POWER DISSIPATION FOR A SURFACE MOUNT DEVICE

The values for the equation are found in the maximum ratings table on the data sheet. Substituting these values into the equation for an ambient temperature T_A of 25°C, one can calculate the power dissipation of the device. For example, for a D2PAK, P_D is calculated as follows.

$$P_D = \frac{150^\circ\text{C} - 25^\circ\text{C}}{50^\circ\text{C/W}} = 2.5 \text{ watts}$$

The 50 °C/W for the D2PAK package assumes the use of the recommended footprint on a glass epoxy printed circuit board to achieve a power dissipation of 2.5 watts. There are other alternatives to achieving higher power dissipation from the surface mount packages. One is to increase the area of the drain/collector pad. By increasing the area of the drain/collector pad, the power dissipation can be increased.

Although the power dissipation can almost be doubled with this method, area is taken up on the printed circuit board which can defeat the purpose of using surface mount technology. For example, a graph of $R_{\theta JA}$ versus drain pad area is shown in Figures 1 and 2.

Another alternative would be to use a ceramic substrate or an aluminum core board such as Thermal Clad™. Using a board material such as Thermal Clad, an aluminum core board, the power dissipation can be doubled using the same footprint.

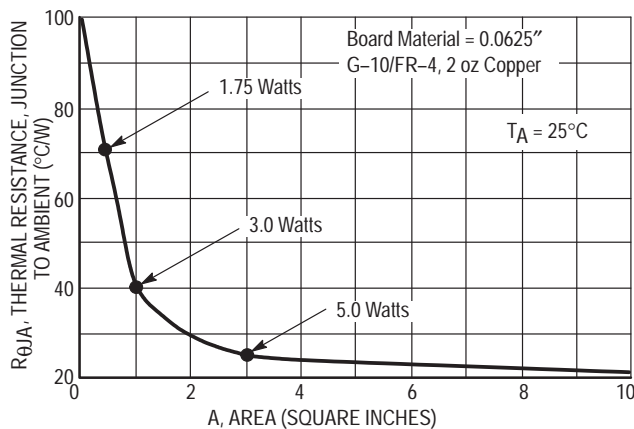

Figure 1. Thermal Resistance versus Drain Pad Area for the DPAK Package (Typical)

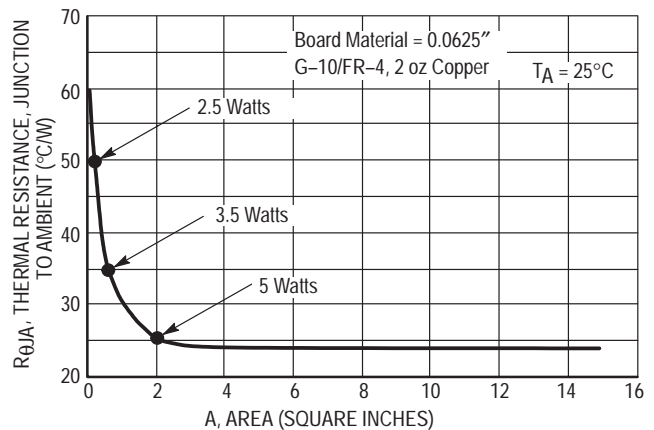

Figure 2. Thermal Resistance versus Drain Pad Area for the D2PAK Package (Typical)

Prior to placing surface mount components onto a printed circuit board, solder paste must be applied to the pads. Solder stencils are used to screen the optimum amount. These stencils are typically 0.008 inches thick and may be made of brass or stainless steel. This is not the case with the DPAK and D²PAK packages. If a 1:1 opening is used to screen solder onto the drain pad, misalignment and/or “tombstoning” may occur due to an excess of solder. For these two packages, the opening in the stencil for the paste should be approximately 50% of the tab area. The opening for the leads is still a 1:1 registration. Figure 3 shows a typical stencil for the DPAK and D²PAK packages. The pattern of the opening in the stencil for the drain pad is not critical as long as it allows approximately 50% of the pad to be covered with paste.

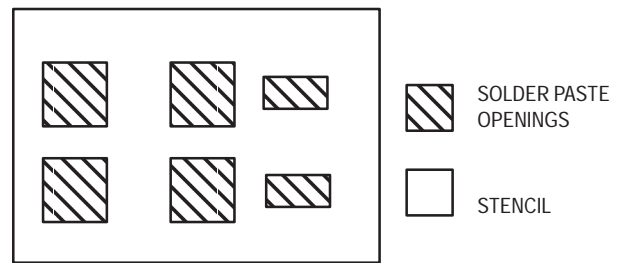

Figure 3. Typical Stencil for DPAK and D²PAK Packages

SOLDERING PRECAUTIONS

The melting temperature of solder is higher than the rated temperature of the device. When the entire device is heated to a high temperature, failure to complete soldering within a short time could result in device failure. Therefore, the following items should always be observed in order to minimize the thermal stress to which the devices are subjected.

- Always preheat the device.
- The delta temperature between the preheat and soldering should be 100°C or less.*
- When preheating and soldering, the temperature of the leads and the case must not exceed the maximum temperature ratings as shown on the data sheet. When using infrared heating with the reflow soldering method, the difference should be a maximum of 10°C.
- The soldering temperature and time should not exceed 260°C for more than 10 seconds.
- When shifting from preheating to soldering, the maximum temperature gradient shall be 5°C or less.

- After soldering has been completed, the device should be allowed to cool naturally for at least three minutes. Gradual cooling should be used since the use of forced cooling will increase the temperature gradient and will result in latent failure due to mechanical stress.
- Mechanical stress or shock should not be applied during cooling.

* Soldering a device without preheating can cause excessive thermal shock and stress which can result in damage to the device.

* Due to shadowing and the inability to set the wave height to incorporate other surface mount components, the D²PAK is not recommended for wave soldering.

TYPICAL SOLDER HEATING PROFILE

For any given circuit board, there will be a group of control settings that will give the desired heat pattern. The operator must set temperatures for several heating zones and a figure for belt speed. Taken together, these control settings make up a heating "profile" for that particular circuit board. On machines controlled by a computer, the computer remembers these profiles from one operating session to the next. Figure 5 shows a typical heating profile for use when soldering a surface mount device to a printed circuit board. This profile will vary among soldering systems, but it is a good starting point. Factors that can affect the profile include the type of soldering system in use, density and types of components on the board, type of solder used, and the type of board or substrate material being used. This profile shows temperature versus time. The line on the graph shows the

actual temperature that might be experienced on the surface of a test board at or near a central solder joint. The two profiles are based on a high density and a low density board. The Vitronics SMD310 convection/infrared reflow soldering system was used to generate this profile. The type of solder used was 62/36/2 Tin Lead Silver with a melting point between 177–189°C. When this type of furnace is used for solder reflow work, the circuit boards and solder joints tend to heat first. The components on the board are then heated by conduction. The circuit board, because it has a large surface area, absorbs the thermal energy more efficiently, then distributes this energy to the components. Because of this effect, the main body of a component may be up to 30 degrees cooler than the adjacent solder joints.

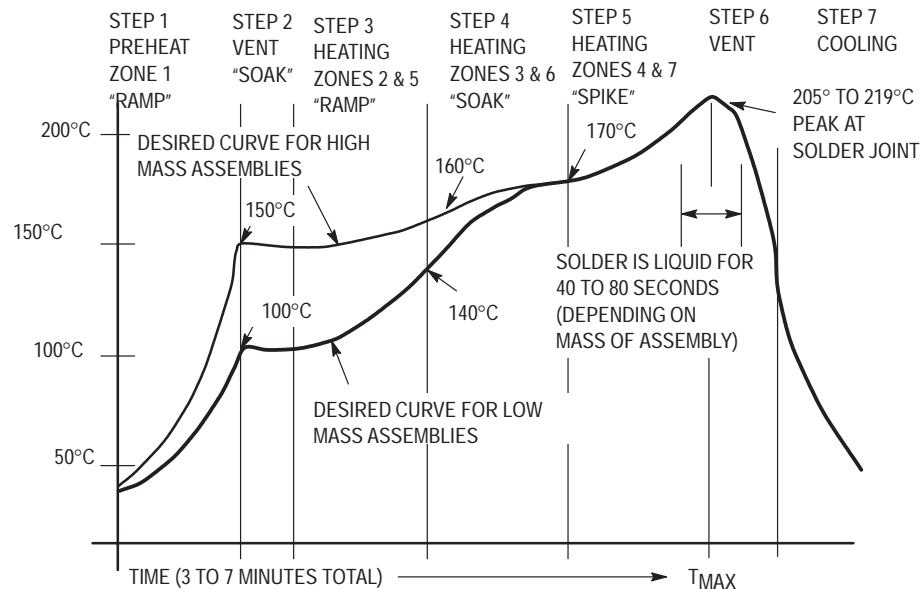

Figure 4. Typical Solder Heating Profile

Mounting Hardware and Techniques

There are many methods available and options possible for installing power semiconductors. A complete discussion of mounting is contained in Motorola Application Note AN1040, "Mounting Considerations for Power Semiconductors," reprinted in Section 6 of this data book. Various suppliers of mounting hardware, listed below, may be contacted for their catalogs which contain considerable technical information.

Sources for Mounting Hardware

Manufacturer	Joint Compound	Adhesives	Insulators						Heatsinks	Clips	
			BeO	AlO ₂	Anodize	Mica	Plastic Film	Silicone Rubber			
Aavid Eng.	—	—	—	—	—	—	—	X	X	X	X
AHAM-TOR	—	—	—	—	—	—	—	—	—	X	—
Asheville-Schoonmaker	—	—	—	—	—	—	X	—	—	—	—
Astroynamics	X	—	—	—	—	—	—	—	—	X	—
Delbert Blinn	—	—	X	—	X	X	X	X	X	X	—
IERC	X	—	—	—	—	—	—	—	—	X	—
Staver	—	—	—	—	—	—	—	—	—	X	—
Thermalloy	X	X	X	X	X	X	X	X	X	X	X
Tran-tec	X	—	X	X	X	X	X	—	X	X	—
Wakefield Eng.	X	X	X	—	X	—	—	—	X	X	X

Other sources for silicone rubber pads: Chomerics, Berquist

Suppliers Addresses

Aavid Engineering, Inc., P.O. Box 400, Laconia, New Hampshire 03247 (603) 528-1478

AHAM-TOR Heatsinks, 27901 Front Street, Rancho, California 92390 (714) 676-4151

Asheville-Schoonmaker, 900 Jefferson Ave., Newport News, VA 23607 (804) 244-7311

Astro Dynamics, Inc., 2 Gill St., Woburn, Massachusetts 01801 (617) 935-4944

Berquist, 5300 Edina Industrial Blvd., Minneapolis, Minnesota 55435 (612) 835-2322

Chomerics, Inc., 16 Flagstone Drive, Hudson, New Hampshire 03051 1-800-633-8800

Delbert Blinn Company, P.O. Box 2007, Pomona, California 91769 (714) 623-1257

International Electronic Research Corporation, 135 West Magnolia Boulevard, Burbank, California 91502 (213) 849-2481

The Staver Company, Inc., 41-51 Saxon Avenue, Bay Shore, Long Island, New York 11706 (516) 666-8000

Thermalloy, Inc., P.O. Box 34829, 2021 West Valley View Lane, Dallas, Texas 75234 (214) 243-4321

Tran-tec Corporation, P.O. Box 1044, Columbus, Nebraska 68601 (402) 564-2748

Wakefield Engineering, Inc., Wakefield, Massachusetts 01880 (617) 245-5900

Tape and Reel Specifications and Packaging Specifications

Embossed Tape and Reel is used to facilitate automatic pick and place equipment feed requirements. The tape is used as the shipping container for various products and requires a minimum of handling. The antistatic/conductive tape provides a secure cavity for the product when sealed with the “peel-back” cover tape.

- Two Reel Sizes Available (7” and 13”)
- Used for Automatic Pick and Place Feed Systems
- Minimizes Product Handling
- EIA 481, -1, -2
- DPAK SO-14, in 16 mm Tape
- D²PAK in 24 mm Tape

Use the standard device title and add the required suffix as listed in the option table on the following page. Note that the individual reels have a finite number of devices depending on the type of product contained in the tape. Also note the minimum lot size is one full reel for each line item, and orders are required to be in increments of the single reel quantity.

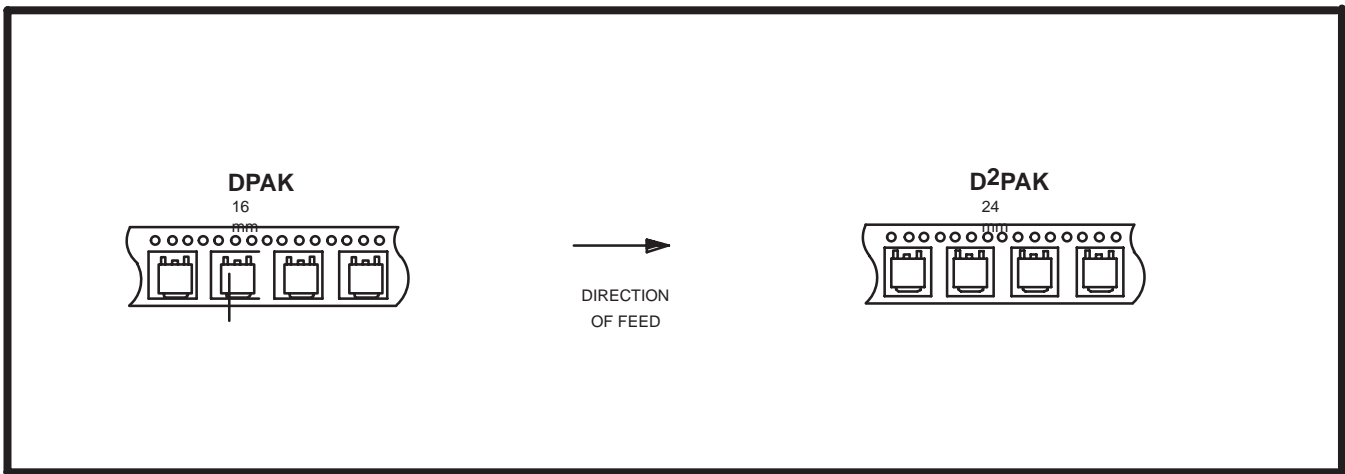

Package	Tape Width (mm)	Reel Size (inch)				
DPAK	16	8.0 ± 0.1 (.315 ± .004)	330	(13)	2,500	T4
D ² PAK	24	16.0 ± 0.1 (.630 ± .004)	330	(13)	800	T4

Outline Dimensions

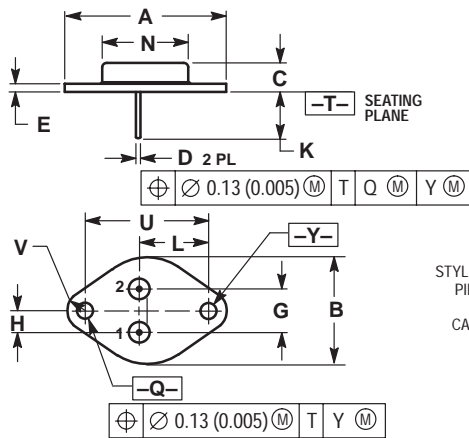

STYLE 1:
PIN 1. BASE
2. EMITTER
CASE: COLLECTOR

- NOTES:
1. DIMENSIONING AND TOLERANCING PER ANSI Y14.5M, 1982.
2. CONTROLLING DIMENSION: INCH.
3. ALL RULES AND NOTES ASSOCIATED WITH REFERENCED TO-204AA OUTLINE SHALL APPLY.

DIM	INCHES		MILLIMETERS	
	MIN	MAX	MIN	MAX
A	1.550 REF	---	39.37 REF	---
B	---	1.050	---	26.67
C	0.250	0.335	6.35	8.51
D	0.038	0.043	0.97	1.09
E	0.055	0.070	1.40	1.77
G	0.430 BSC	---	10.92 BSC	---
H	0.215 BSC	---	5.46 BSC	---
K	0.440	0.480	11.18	12.19
L	0.665 BSC	---	16.89 BSC	---
N	---	0.830	---	21.08
Q	0.151	0.165	3.84	4.19
U	1.187 BSC	---	30.15 BSC	---
V	0.131	0.188	3.33	4.77

**CASE 1-07
(TO-204AA)**

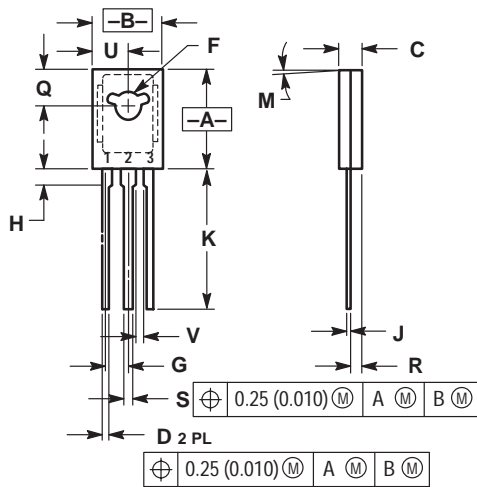

STYLE 1:
PIN 1. EMITTER
2. COLLECTOR
3. BASE

- NOTES:
1. DIMENSIONING AND TOLERANCING PER ANSI Y14.5M, 1982.
2. CONTROLLING DIMENSION: INCH.

DIM	INCHES		MILLIMETERS	
	MIN	MAX	MIN	MAX
A	0.425	0.435	10.80	11.04
B	0.295	0.305	7.50	7.74
C	0.095	0.105	2.42	2.66
D	0.020	0.026	0.51	0.66
F	0.115	0.130	2.93	3.30
G	0.094 BSC	---	2.39 BSC	---
H	0.050	0.095	1.27	2.41
J	0.015	0.025	0.39	0.63
K	0.575	0.655	14.61	16.63
M	5° TYP	---	5° TYP	---
Q	0.148	0.158	3.76	4.01
R	0.045	0.055	1.15	1.39
S	0.025	0.035	0.64	0.88
U	0.145	0.155	3.69	3.93
V	0.040	---	1.02	---

**CASE 77-08
(TO-225AA)**

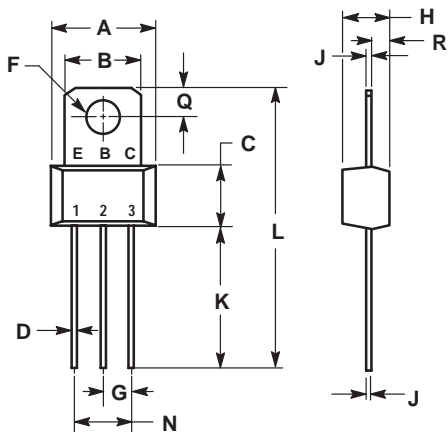

STYLE 1:
PIN 1. EMITTER
2. BASE
3. COLLECTOR
(COLLECTOR CONNECTED TO TAB)

- NOTES:
1. LEADS WITHIN 0.15 (0.006) TOTAL OF TRUE POSITION AT CASE, AT MAXIMUM MATERIAL CONDITION.

DIM	MILLIMETERS		INCHES	
	MIN	MAX	MIN	MAX
A	9.14	9.53	0.360	0.375
B	6.60	7.24	0.260	0.285
C	5.41	5.66	0.213	0.223
D	0.38	0.53	0.015	0.021
F	3.18	3.33	0.125	0.131
G	2.54 BSC	---	0.100 BSC	---
H	3.94	4.19	0.155	0.165
J	0.36	0.41	0.014	0.016
K	11.63	12.70	0.458	0.500
L	24.58	25.53	0.968	1.005
N	5.08 BSC	---	0.200 BSC	---
Q	2.39	2.69	0.094	0.106
R	1.14	1.40	0.045	0.055

CASE 152-02

Outline Dimensions (continued)

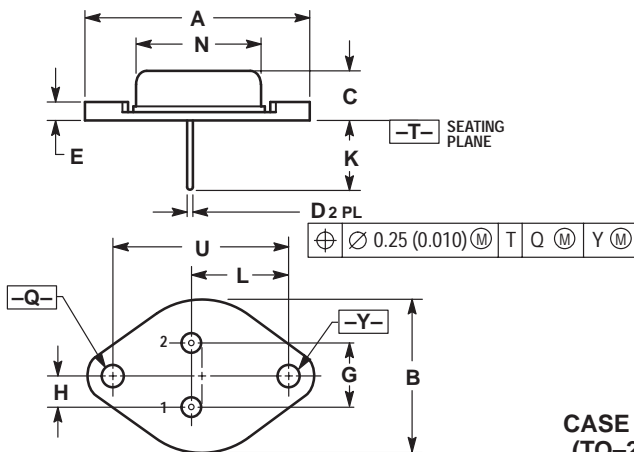

STYLE 1:
PIN 1: BASE
2: EMITTER
CASE: COLLECTOR

**CASE 197-05
(TO-204AE)**

- NOTES:
1. DIMENSIONING AND TOLERANCING PER ANSI Y14.5M, 1982.
2. CONTROLLING DIMENSION: INCH.

DIM	INCHES		MILLIMETERS	
	MIN	MAX	MIN	MAX
A	1.510	1.550	38.35	39.37
B	0.980	1.050	24.89	26.67
C	0.250	0.335	6.35	8.51
D	0.057	0.063	1.45	1.60
E	0.060	0.135	1.52	3.43
G	0.420	0.440	10.67	11.18
H	0.205	0.225	5.21	5.72
K	0.440	0.480	11.18	12.19
L	0.655	0.675	16.64	17.15
N	0.760	0.830	19.30	21.08
Q	0.151	0.175	3.84	4.19
U	1.177	1.197	29.90	30.40

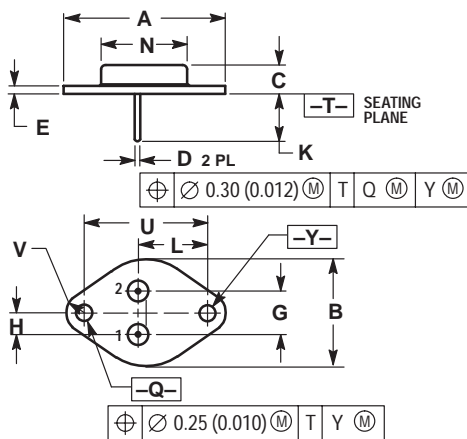

STYLE 1:
PIN 1: BASE
2: EMITTER
CASE: COLLECTOR

**CASE 197A-05
(TO-204AA)**

- NOTES:
1. DIMENSIONING AND TOLERANCING PER ANSI Y14.5M, 1982.
2. CONTROLLING DIMENSION: INCH.

DIM	INCHES		MILLIMETERS	
	MIN	MAX	MIN	MAX
A	1.530 REF		38.86 REF	
B	0.990	1.050	25.15	26.67
C	0.250	0.335	6.35	8.51
D	0.057	0.063	1.45	1.60
E	0.060	0.070	1.53	1.77
G	0.430 BSC		10.92 BSC	
H	0.215 BSC		5.46 BSC	
K	0.440	0.480	11.18	12.19
L	0.665 BSC		16.89 BSC	
N	0.760	0.830	19.31	21.08
Q	0.151	0.165	3.84	4.19
U	1.187 BSC		30.15 BSC	
V	0.131	0.188	3.33	4.77

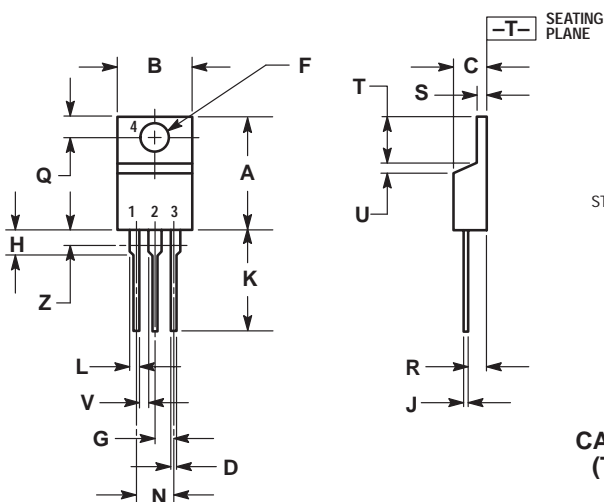

STYLE 1:
PIN 1: BASE
2: COLLECTOR
3: EMITTER
4: COLLECTOR

**CASE 221A-06
(TO220-AB)**

- NOTES:
1. DIMENSIONING AND TOLERANCING PER ANSI Y14.5M, 1982.
2. CONTROLLING DIMENSION: INCH.
3. DIMENSION Z DEFINES A ZONE WHERE ALL BODY AND LEAD IRREGULARITIES ARE ALLOWED.

DIM	INCHES		MILLIMETERS	
	MIN	MAX	MIN	MAX
A	0.570	0.620	14.48	15.75
B	0.380	0.405	9.66	10.28
C	0.160	0.190	4.07	4.82
D	0.025	0.035	0.64	0.88
F	0.142	0.147	3.61	3.73
G	0.095	0.105	2.42	2.66
H	0.110	0.155	2.80	3.93
J	0.018	0.025	0.46	0.64
K	0.500	0.562	12.70	14.27
L	0.045	0.060	1.15	1.52
N	0.190	0.210	4.83	5.33
Q	0.100	0.120	2.54	3.04
R	0.080	0.110	2.04	2.79
S	0.045	0.055	1.15	1.39
T	0.235	0.255	5.97	6.47
U	0.000	0.050	0.00	1.27
V	0.045	---	1.15	---
Z	---	0.080	---	2.04

Outline Dimensions (continued)

STYLE 2:
PIN 1. BASE
2. COLLECTOR
3. EMITTER

**CASE 221D-02
(TO-220)**

DIM	INCHES		MILLIMETERS	
	MIN	MAX	MIN	MAX
A	0.621	0.629	15.78	15.97
B	0.394	0.402	10.01	10.21
C	0.181	0.189	4.60	4.80
D	0.026	0.034	0.67	0.86
F	0.121	0.129	3.08	3.27
G	0.100 BSC		2.54 BSC	
H	0.123	0.129	3.13	3.27
J	0.018	0.025	0.46	0.64
K	0.500	0.562	12.70	14.27
L	0.045	0.060	1.14	1.52
N	0.200 BSC		5.08 BSC	
Q	0.126	0.134	3.21	3.40
R	0.107	0.111	2.72	2.81
S	0.096	0.104	2.44	2.64
U	0.259	0.267	6.58	6.78

STYLE 1:
PIN 1. BASE
2. COLLECTOR
3. EMITTER
4. COLLECTOR

**CASE 340D-01
(TO-218)**

DIM	MILLIMETERS		INCHES	
	MIN	MAX	MIN	MAX
A	19.00	19.60	0.749	0.771
B	14.00	14.50	0.551	0.570
C	4.20	4.70	0.165	0.185
D	1.00	1.30	0.040	0.051
E	1.45	1.65	0.058	0.064
G	5.21	5.72	0.206	0.225
H	2.60	3.00	0.103	0.118
J	0.40	0.60	0.016	0.023
K	28.50	32.00	1.123	1.259
L	14.70	15.30	0.579	0.602
Q	4.00	4.25	0.158	0.167
S	17.50	18.10	0.689	0.712
U	3.40	3.80	0.134	0.149
V	1.50	2.00	0.060	0.078

STYLE 3:
PIN 1. BASE
2. COLLECTOR
3. EMITTER
4. COLLECTOR

**CASE 340F-03
(TO-247AE)**

DIM	MILLIMETERS		INCHES	
	MIN	MAX	MIN	MAX
A	20.40	20.90	0.803	0.823
B	15.44	15.95	0.608	0.628
C	4.70	5.21	0.185	0.205
D	1.09	1.30	0.043	0.051
E	1.50	1.63	0.059	0.064
F	1.80	2.18	0.071	0.086
G	5.45 BSC		0.215 BSC	
H	2.56	2.87	0.101	0.113
J	0.48	0.68	0.019	0.027
K	15.57	16.08	0.613	0.633
L	7.26	7.50	0.286	0.295
P	3.10	3.38	0.122	0.133
Q	3.50	3.70	0.138	0.145
R	3.30	3.80	0.130	0.150
U	5.30 BSC		0.209 BSC	
V	3.05	3.40	0.120	0.134

Outline Dimensions (continued)

$\oplus \varnothing 0.25 (0.010) \text{ (M) T B (M)}$
 $\oplus 0.25 (0.010) \text{ (M) Y Q (S)}$

STYLE 2:
 PIN 1. BASE
 2. COLLECTOR
 3. EMITTER

CASE 340G-02 (TO-3PBL)

NOTES:
 1. DIMENSIONING AND TOLERANCING PER ANSI Y14.5M, 1982.
 2. CONTROLLING DIMENSION: MILLIMETER.

DIM	MILLIMETERS		INCHES	
	MIN	MAX	MIN	MAX
A	2.8	2.9	1.102	1.142
B	19.3	20.3	0.760	0.800
C	4.7	5.3	0.185	0.209
D	0.93	1.48	0.037	0.058
E	1.9	2.1	0.075	0.083
F	2.2	2.4	0.087	0.102
G	5.45 BSC		0.215 BSC	
H	2.6	3.0	0.102	0.118
J	0.43	0.78	0.017	0.031
K	17.6	18.8	0.693	0.740
L	11.0	11.4	0.433	0.449
N	3.95	4.75	0.156	0.187
P	2.2	2.6	0.087	0.102
Q	3.1	3.5	0.122	0.137
R	2.15	2.35	0.085	0.093
U	6.1	6.5	0.240	0.256
W	2.8	3.2	0.110	0.125

$\oplus 0.13 (0.005) \text{ (M) T}$

STYLE 1:
 PIN 1. BASE
 2. COLLECTOR
 3. EMITTER
 4. COLLECTOR

CASE 369-07

NOTES:
 1. DIMENSIONING AND TOLERANCING PER ANSI Y14.5M, 1982.
 2. CONTROLLING DIMENSION: INCH.

DIM	INCHES		MILLIMETERS	
	MIN	MAX	MIN	MAX
A	0.235	0.250	5.97	6.35
B	0.250	0.265	6.35	6.73
C	0.086	0.094	2.19	2.38
D	0.027	0.035	0.69	0.88
E	0.033	0.040	0.84	1.01
F	0.037	0.047	0.94	1.19
G	0.090 BSC		2.29 BSC	
H	0.034	0.040	0.87	1.01
J	0.018	0.023	0.46	0.58
K	0.350	0.380	8.89	9.65
R	0.175	0.215	4.45	5.46
S	0.050	0.090	1.27	2.28
V	0.030	0.050	0.77	1.27

$\oplus 0.13 (0.005) \text{ (M) T}$

STYLE 1:
 PIN 1. BASE
 2. COLLECTOR
 3. EMITTER
 4. COLLECTOR

CASE 369A-13

NOTES:
 1. DIMENSIONING AND TOLERANCING PER ANSI Y14.5M, 1982.
 2. CONTROLLING DIMENSION: INCH.

DIM	INCHES		MILLIMETERS	
	MIN	MAX	MIN	MAX
A	0.235	0.250	5.97	6.35
B	0.250	0.265	6.35	6.73
C	0.086	0.094	2.19	2.38
D	0.027	0.035	0.69	0.88
E	0.033	0.040	0.84	1.01
F	0.037	0.047	0.94	1.19
G	0.180 BSC		4.58 BSC	
H	0.034	0.040	0.87	1.01
J	0.018	0.023	0.46	0.58
K	0.102	0.114	2.60	2.89
L	0.090 BSC		2.29 BSC	
R	0.175	0.215	4.45	5.46
S	0.020	0.050	0.51	1.27
U	0.020	---	0.51	---
V	0.030	0.050	0.77	1.27
Z	0.138	---	3.51	---

Leadform Options — TO-220 (Case 221A)

- Leadform options require assignment of a special part number before ordering.
- Contact your local Motorola representative for special part number and pricing.
- 10,000 piece minimum quantity orders are required.
- Leadform orders are non-cancellable after processing.
- Leadforms apply to both Motorola Case 221A-04 and 221A-06 except as noted.

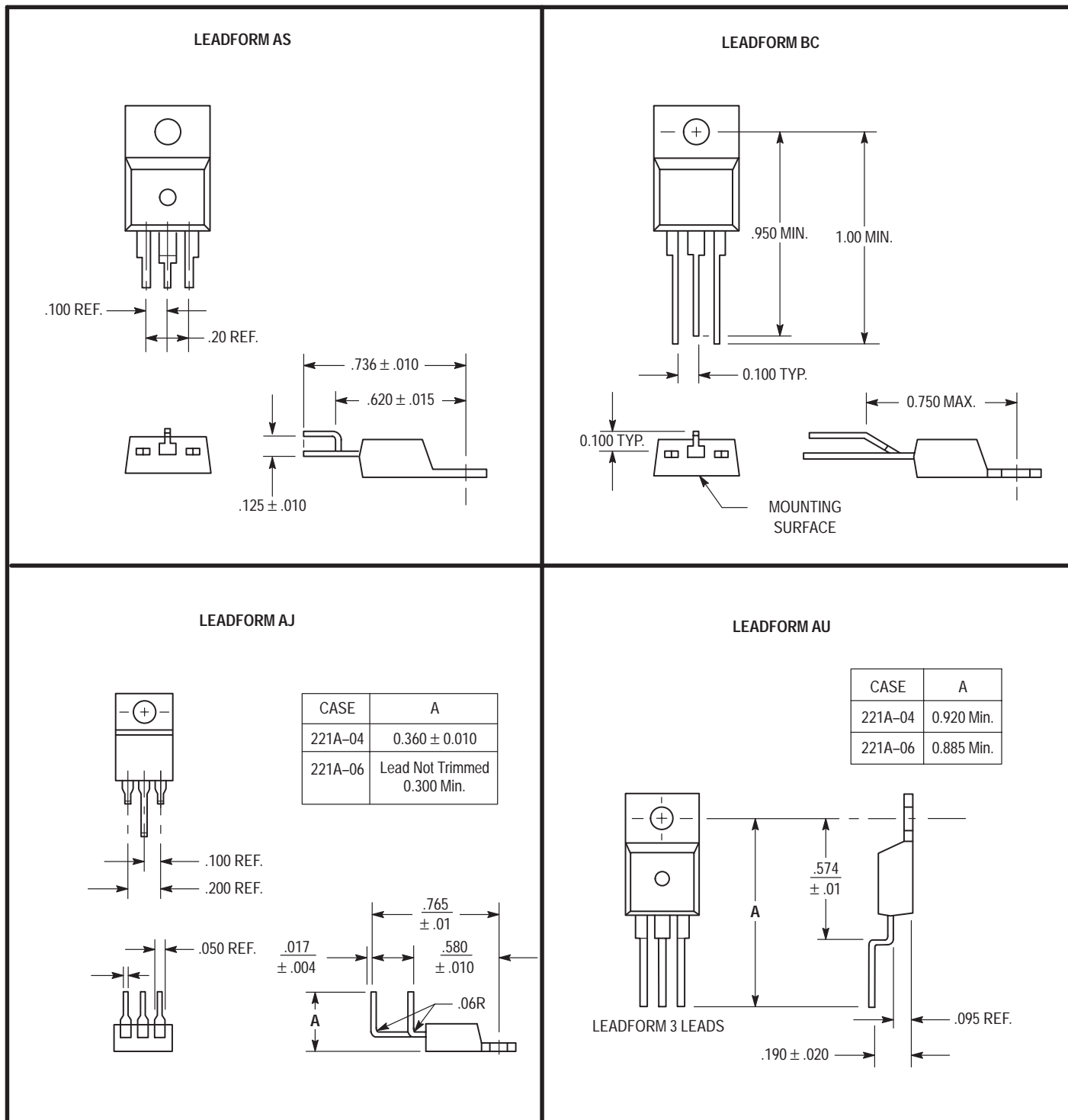

TO-220 Leadform Options (continued)

LEADFORM AN

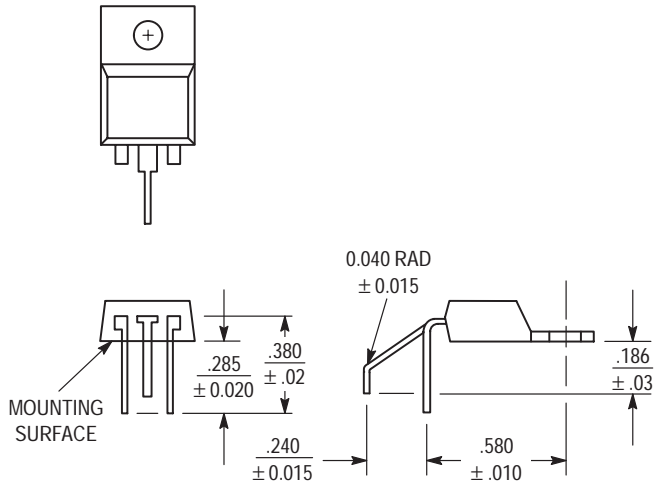

LEADFORM BA

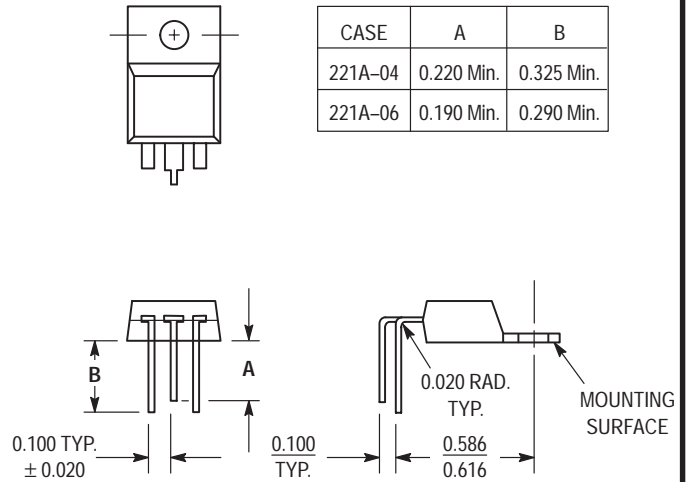

LEADFORM BG

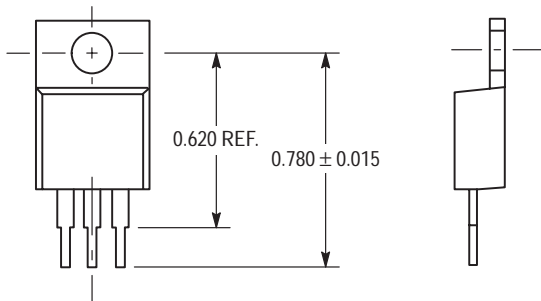

LEADFORM AK

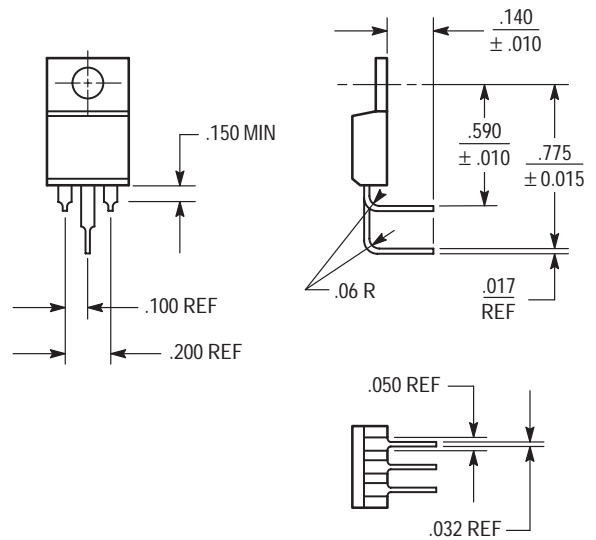

TO-220 Leadform Options (continued)

LEADFORM BU

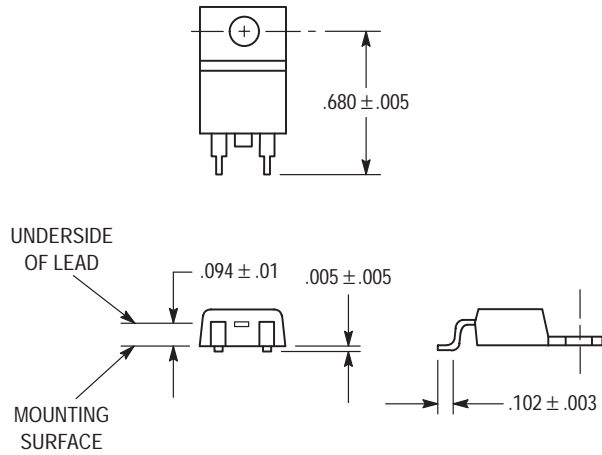

LEADFORM BV

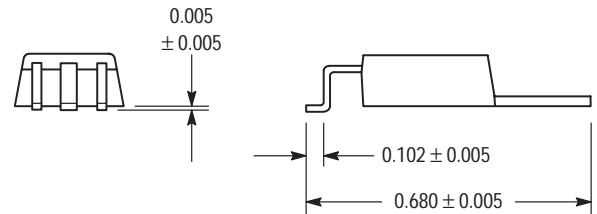

LEADFORM BD

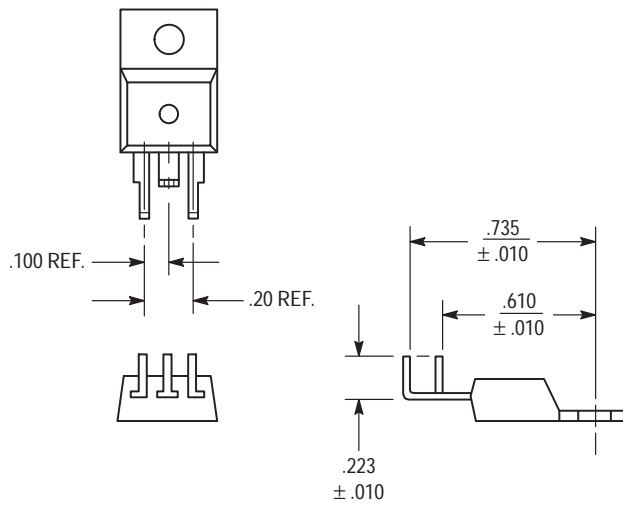

LEADFORM DW

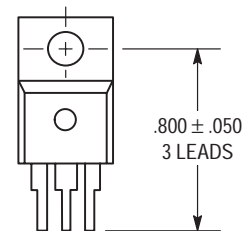

TO-220 Leadform Options (continued)

LEADFORM AF

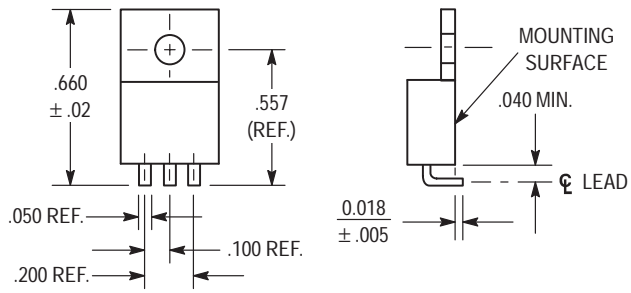

LEADFORM BS

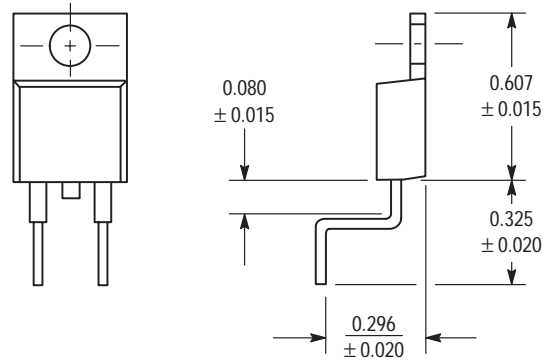

INDEX AND CROSS REFERENCE

The following table represents an index and cross-reference guide for all low-frequency power transistors which are either manufactured directly by Motorola or for which Motorola manufactures a suitable equivalent. Where the Motorola part number differs from the industry part number, the Motorola device is a "form, fit and function" replacement for the industry type number — however, subtle differences in characteristics and/or specifications may exist. Where multiple replacement parts appear for a given industry part number, the page number represents the first replacement device listed.

Industry Part Number	Motorola Nearest Replacement	Motorola Similar Replacement	Page Number	Industry Part Number	Motorola Nearest Replacement	Motorola Similar Replacement	Page Number
40251		2N3055	3-2	2N3055H		2N3055A	3-5
40325		2N3055	3-2	2N3055SD		2N3055A	3-5
40363		2N5878	3-74	2N3055UB		2N3055A	3-5
40369		2N5878	3-74	2N3076		BUV23	3-388
40411		MJ802	3-421	2N3171		2N3792	3-25
40513		MJE3055T	3-628	2N3172		2N3792	3-25
40514		MJE3055T	3-628	2N3173		2N3792	3-25
40542		MJE3055T	3-628	2N3174		MJ15016	3-5
40543		MJE3055T	3-628	2N3183		2N3792	3-25
40613		TIP31B	3-873	2N3184		2N3792	3-25
40618		TIP31B	3-873	2N3185		2N3792	3-25
40621		TIP31B	3-873	2N3186		MJ15016	3-5
40622		TIP31B	3-873	2N3195		2N3792	3-25
40624		TIP41B	3-883	2N3196		2N3792	3-25
40627		TIP41B	3-883	2N3198		MJ15016	3-5
40629		TIP31B	3-873	2N3232		2N5878	3-74
40630		TIP31B	3-873	2N3233		2N5882	3-77
40631		TIP31B	3-873	2N3234		2N3442	3-9
40632		TIP41B	3-883	2N3235		2N3055	3-2
40636		2N5878	3-74	2N3236		2N5882	3-77
40853		2N6547	3-140	2N3237		2N5302	3-54
40854		2N6547	3-140	2N3238		2N5882	3-77
40871		TIP41C	3-883	2N3239		2N5882	3-77
40872		TIP42C	3-883	2N3240		2N5882	3-77
40873		TIP41B	3-883	2N3441	2N3442		3-9
40874		TIP41B	3-883	2N3442	2N3442		3-9
40875		TIP41C	3-883	2N3445		2N3716	3-12
40876		TIP41B	3-883	2N3446		2N3716	3-12
40887		MJE340	3-602	2N3447		2N3716	3-12
41012		2N5038	3-42	2N3448		2N3716	3-12
41013		2N6339	3-117	2N3667		2N5882	3-77
41500		TIP31B	3-873	2N3713		2N5882	3-77
41501		TIP32B	3-873	2N3714	2N3716		3-12
41504		TIP31B	3-873	2N3715	2N3716		3-12
43104		2N5631	3-59	2N3716	2N3716		3-12
1S110A-100		MJ16018	3-520	2N3771	2N3771		3-17
2N1487		2N5878	3-74	2N3772	2N3772		3-17
2N1488		2N5878	3-74	2N3773	2N3773		3-21
2N1489		2N5878	3-74	2N3789	2N3792		3-25
2N1490		2N5878	3-74	2N3790	2N3792		3-25
2N1702		2N5878	3-74	2N3791	2N3792		3-25
2N3021		2N3792	3-25	2N3792	2N3792		3-25
2N3022		2N3792	3-25	2N3863		2N3716	3-12
2N3023		2N3792	3-25	2N3864		2N5882	3-77
2N3024		2N3792	3-25	2N3865		MJ15001	3-497
2N3025		2N3792	3-25	2N3902		BUX48A	3-401
2N3026		2N3792	3-25	2N4002		2N6274	3-108
2N3055	2N3055		3-2	2N4032		2N6274	3-108
2N3055A	2N3055A		3-5	2N4111		2N3716	3-12

INDEX AND CROSS REFERENCE (continued)

Industry Part Number	Motorola Nearest Replacement	Motorola Similar Replacement	Page Number
2N4113		2N3716	3-12
2N4347		2N3055A	3-5
2N4348		2N5631	3-59
2N4398	2N4399		3-29
2N4399	2N4399		3-29
2N4901		MJ15016	3-5
2N4902		MJ15016	3-5
2N4903		MJ15016	3-5
2N4904		MJ15016	3-5
2N4905		MJ15016	3-5
2N4906		MJ15016	3-5
2N4907		2N3792	3-25
2N4908		2N3792	3-25
2N4909		2N3792	3-25
2N4918	2N4918		3-34
2N4919	2N4919		3-34
2N4920	2N4920		3-34
2N4921	2N4921		3-38
2N4922	2N4922		3-38
2N4923	2N4923		3-38
2N5034		2N3055	3-2
2N5035		2N3055	3-2
2N5036		2N3055	3-2
2N5037		2N3055	3-2
2N5038	2N5038		3-42
2N5039	2N5038		3-42
2N5157		BUX48A	3-401
2N5190	2N5191		3-44
2N5191	2N5191		3-44
2N5192	2N5192		3-44
2N5193	2N5194		3-49
2N5194	2N5194		3-49
2N5195	2N5195		3-49
2N5240		BUX48A	3-401
2N5241		BUX48A	3-401
2N5264		BUV23	3-388
2N5293		TIP31B	3-873
2N5294		TIP31B	3-873
2N5295		TIP31B	3-873
2N5296		TIP31B	3-873
2N5297		TIP31B	3-873
2N5298		TIP31B	3-873
2N5301	2N5302		3-54
2N5302	2N5302		3-54
2N5303	2N5303		3-54
2N5386		2N5038	3-42
2N5387		2N6547	3-140
2N5388		2N6547	3-140
2N5389		2N6547	3-140
2N5466		BUX48A	3-401
2N5467		BUX48A	3-401
2N5490		MJE3055T	3-628
2N5491		MJE3055T	3-628
2N5492		2N6292	3-101
2N5493		2N6292	3-101
2N5494		MJE3055T	3-628
2N5495		MJE3055T	3-628
2N5496		2N6292	3-101
2N5497		2N6292	3-101
2N5559		MJ15001	3-497
2N5575		2N5685	3-66
2N5578		2N5685	3-66
2N5614		2N3716	3-12

Industry Part Number	Motorola Nearest Replacement	Motorola Similar Replacement	Page Number
2N5616		2N3716	3-12
2N5618		2N3716	3-12
2N5629		2N5631	3-59
2N5630	2N5631		3-59
2N5631	2N5631		3-59
2N5632		2N5882	3-77
2N5633		MJ15001	3-497
2N5634		MJ15001	3-497
2N5655	2N5657		3-63
2N5656	2N5657		3-63
2N5657	2N5657		3-63
2N5659		2N5631	3-59
2N5683	2N5684		3-66
2N5684	2N5684		3-66
2N5685	2N5685		3-66
2N5686	2N5686		3-66
2N5733		2N6274	3-108
2N5734		2N6338	3-117
2N5737		2N5878	3-74
2N5738		2N5880	3-77
2N5739		2N5878	3-74
2N5740		2N5880	3-77
2N5741		2N5884	3-81
2N5742		2N6031	3-59
2N5743		2N5884	3-81
2N5744		MJ4502	3-431
2N5745	2N5745		3-29
2N5758	2N5758		3-70
2N5759		2N3055A	3-5
2N5760		2N3442	3-9
2N5867		2N3792	3-25
2N5868		2N3792	3-25
2N5869		2N3716	3-12
2N5870		2N3716	3-12
2N5871		2N3792	3-25
2N5872		2N3792	3-25
2N5873		2N3716	3-12
2N5874		2N3716	3-12
2N5877	2N5878		3-74
2N5878	2N5878		3-74
2N5879	2N5880		3-77
2N5880	2N5880		3-77
2N5881	2N5882		3-77
2N5882	2N5882		3-77
2N5883	2N5884		3-81
2N5884	2N5884		3-81
2N5885	2N5886		3-81
2N5886	2N5886		3-81
2N5929		2N6338	3-117
2N5930		2N6338	3-117
2N5931		2N6341	3-117
2N5932		2N6338	3-117
2N5933		2N6338	3-117
2N5935		2N6341	3-117
2N5936		2N6338	3-117
2N5937		2N6341	3-117
2N5970		2N5882	3-77
2N5971		2N5882	3-77
2N5972		MJ15003	3-500
2N5973		2N5886	3-81
2N5974		MJE2955T	3-628
2N5975		MJE2955T	3-628
2N5976		MJE2955T	3-628

INDEX AND CROSS REFERENCE (continued)

Industry Part Number	Motorola Nearest Replacement	Motorola Similar Replacement	Page Number
2N5977		MJE3055T	3-628
2N5978		MJE3055T	3-628
2N5979		MJE3055T	3-628
2N5980		MJE2955T	3-628
2N5981		MJE2955T	3-628
2N5982		2N6490	3-132
2N5983		MJE3055T	3-628
2N5984		MJE3055T	3-628
2N5985		2N6488	3-132
2N5986		2N6490	3-132
2N5987		2N6490	3-132
2N5988		2N6490	3-132
2N5989		2N6486	—
2N5990		2N6488	3-132
2N5991		2N6488	3-132
2N6021		TIP32C	3-873
2N6022		TIP32C	3-873
2N6023		TIP32B	3-873
2N6024		TIP32B	3-873
2N6025		TIP32B	3-873
2N6026		TIP32B	3-873
2N6029		2N6031	3-59
2N6030	2N6031		3-59
2N6031	2N6031		3-59
2N6032		2N6275	3-108
2N6033		2N6277	3-108
2N6034	2N6035		3-85
2N6035	2N6035		3-85
2N6036	2N6036		3-85
2N6037	2N6038		3-85
2N6038	2N6038		3-85
2N6039	2N6039		3-85
2N6040	2N6041		3-89
2N6041	2N6041		3-89
2N6042	2N6042		3-89
2N6043	2N6044		3-89
2N6044	2N6044		3-89
2N6045	2N6045		3-89
2N6049	2N6049		—
2N6050	2N6052		3-93
2N6051	2N6052		3-93
2N6052	2N6052		3-93
2N6055	2N6056		3-97
2N6056	2N6056		3-97
2N6057	2N6059		3-93
2N6058	2N6059		3-93
2N6059	2N6059		3-93
2N6098		2N6487	3-132
2N6099		2N6487	3-132
2N6100		2N6487	3-132
2N6101		2N6488	3-132
2N6102		2N6488	3-132
2N6103		2N6487	3-132
2N6106		2N6107	3-101
2N6107	2N6107		3-101
2N6108		2N6109	3-101
2N6109	2N6109		3-101
2N6110		2N6107	3-101
2N6111	2N6107		3-101
2N6121		TIP31B	3-873
2N6122		TIP31B	3-873
2N6123		TIP31B	3-873
2N6124		TIP32B	3-873

Industry Part Number	Motorola Nearest Replacement	Motorola Similar Replacement	Page Number
2N6125		TIP32B	3-873
2N6126		TIP32C	3-873
2N6127		2N6437	3-128
2N6128		2N6338	3-117
2N6129		TIP41B	3-883
2N6130		TIP41B	3-883
2N6131		TIP41B	3-883
2N6132		TIP42C	3-883
2N6133		TIP42C	3-883
2N6134		TIP42C	3-883
2N6177		MJE340	3-602
2N6226		MJ15016	3-5
2N6227		MJ15016	3-5
2N6228		MJ15016	3-5
2N6229		2N5880	3-77
2N6230		MJ15002	3-497
2N6231		MJ15002	3-497
2N6246		2N5880	3-77
2N6247		2N5880	3-77
2N6248		MJ15016	3-5
2N6249		BUV23	3-388
2N6250		BUV23	3-388
2N6253		2N5878	3-74
2N6254		2N5878	3-74
2N6257		2N5886	3-81
2N6258		2N5686	3-66
2N6259		2N5631	3-59
2N6262		2N3442	3-9
2N6270		2N6338	3-117
2N6271		2N6338	3-117
2N6272		2N6338	3-117
2N6273		2N6338	3-117
2N6274	2N6274		3-108
2N6275	2N6275		3-108
2N6276		2N6275	3-108
2N6277	2N6277		3-108
2N6278		2N6274	3-108
2N6279		2N6275	3-108
2N6280		2N6275	3-108
2N6281		2N6277	3-108
2N6282	2N6283		3-112
2N6283	2N6283		3-112
2N6284	2N6284		3-112
2N6285	2N6286		3-112
2N6286	2N6286		3-112
2N6287	2N6287		3-112
2N6288	2N6292		3-101
2N6289		2N6292	3-101
2N6290	2N6292		3-101
2N6291	2N6292		3-101
2N6292	2N6292		3-101
2N6293		2N6292	3-101
2N6302		2N5631	3-59
2N6322		MJ10015	3-461
2N6323		MJ10015	3-461
2N6324		MJ10015	3-461
2N6325		MJ10015	3-461
2N6326	2N6328		—
2N6327	2N6328		—
2N6328	2N6328		—
2N6329		2N5884	3-81
2N6330		2N5884	3-81
2N6331		2N5884	3-81

INDEX AND CROSS REFERENCE (continued)

Industry Part Number	Motorola Nearest Replacement	Motorola Similar Replacement	Page Number
2N6338	2N6338		3-117
2N6339	2N6339		3-117
2N6340	2N6341		3-117
2N6341	2N6341		3-117
2N6354		2N6339	3-117
2N6355		2N6059	3-93
2N6356		2N6059	3-93
2N6357		2N6059	3-93
2N6358		2N6059	3-93
2N6359		2N5886	3-81
2N6371		2N3055	3-2
2N6372		2N6316	—
2N6373		2N6315	—
2N6374		2N6315	—
2N6379	2N6379		3-120
2N6382		2N6379	3-120
2N6383		MJ3001	3-425
2N6384		MJ3001	3-425
2N6385		MJ3001	3-425
2N6386		TIP101	3-891
2N6387	2N6387		3-124
2N6388	2N6388		3-124
2N6406		MJE171	3-589
2N6407		MJE172	3-589
2N6408		MJE181	3-589
2N6409		MJE182	3-589
2N6410		MJE200	3-592
2N6411		MJE210	3-592
2N6412		MJE181	3-589
2N6413		MJE181	3-589
2N6414		MJE171	3-589
2N6415		MJE171	3-589
2N6416		MJE243	3-596
2N6417		MJE243	3-596
2N6418		MJE253	3-596
2N6419		MJE253	3-596
2N6436	2N6437		3-128
2N6437	2N6437		3-128
2N6438	2N6438		3-128
2N6465		MJE15030	3-684
2N6466		MJE15030	3-684
2N6467		MJE15031	3-684
2N6468		MJE15031	3-684
2N6469		2N5880	3-77
2N6470		2N5882	3-77
2N6471		2N5882	3-77
2N6472		2N5882	3-77
2N6473		MJE15028	3-684
2N6474		MJE15028	3-684
2N6475		MJE15029	3-684
2N6476		MJE15029	3-684
2N6477		MJE15028	3-684
2N6478		MJE15030	3-684
2N6486	2N6487		3-132
2N6487	2N6487		3-132
2N6488	2N6488		3-132
2N6489	2N6490		3-132
2N6490	2N6490		3-132
2N6491	2N6491		3-132
2N6492		2N6056	3-97
2N6493		2N6056	3-97
2N6494		2N6056	3-97
2N6495		2N6316	—

Industry Part Number	Motorola Nearest Replacement	Motorola Similar Replacement	Page Number
2N6496		2N6339	3-117
2N6497	2N6497		3-136
2N6498	2N6497		3-136
2N6499		MJE13005	3-661
2N6512		BUX48A	3-401
2N6513		BUX48A	3-401
2N6514		BUX48A	3-401
2N6530		TIP101	3-891
2N6531		TIP102	3-891
2N6532		TIP102	3-891
2N6535		TIP102	3-891
2N6536		TIP102	3-891
2N6544		BUX48A	3-401
2N6545		BUX48A	3-401
2N6546	2N6547		3-140
2N6547	2N6547		3-140
2N6548		MJE800	3-612
2N6549		MJE800	3-612
2N6551		2N4923	3-38
2N6552		2N4923	3-38
2N6553		2N4923	3-38
2N6554		2N4919	3-34
2N6555		2N4919	3-34
2N6556		2N4919	3-34
2N6557		MJE340	3-602
2N6558		MJE340	3-602
2N6559		MJE340	3-602
2N6569		2N3055	3-2
2N6573		2N6547	3-140
2N6574		2N6547	3-140
2N6575		2N6547	3-140
2N6576	2N6577		3-144
2N6577	2N6577		3-144
2N6578	2N6578		3-144
2N6609	2N6609		3-21
2N6648		MJ2501	3-425
2N6667	2N6667		3-147
2N6668	2N6668		3-147
2N6836	2N6836		3-151
2SA1001		MJ16012	3-128
2SA1002		2N6438	3-128
2SA1003		2N6438	3-128
2SA1007		MJ15002	3-497
2SA1008		TIP32C	3-873
2SA1010		TIP42C	3-883
2SA1011		MJE15031	3-684
2SA1012		TIP42B	3-883
2SA1020		TIP32B	3-873
2SA1040		2N6438	3-128
2SA1041		2N6438	3-128
2SA1042		2N6437	3-128
2SA1043		2N6438	3-128
2SA1044		2N6437	3-128
2SA1045		2N6052	3-93
2SA1046		2N6052	3-93
2SA1063		MJ15016	3-5
2SA1064		MJ15002	3-497
2SA1065		MJ15002	3-497
2SA1067		MJ15002	3-497
2SA1068		MJ15002	3-497
2SA1069		TIP42B	3-883
2SA1110		MJE350	3-606
2SA1111		MJE15031	3-684

INDEX AND CROSS REFERENCE (continued)

Industry Part Number	Motorola Nearest Replacement	Motorola Similar Replacement	Page Number
2SA1112		MJE15031	3-684
2SA1197L		MJD117-1	3-558
2SA1197S		MJD117	3-558
2SA1201		MJD32	3-542
2SA1204		MJD32	3-542
2SA1213		MJD32C	3-542
2SA1241		MJD45H11-1	3-550
2SA1242		MJD210-1	3-569
2SA1243		MJD210-1	3-569
2SA1244		MJD45H11-1	3-550
2SA1307		TIP42B	3-883
2SA1314		MJD32	3-542
2SA1328		2N6490	3-132
2SA1329		2N6491	3-132
2SA1357		TIP42B	3-883
2SA1375		MJD350	3-577
2SA1385		MJD2955	3-580
2SA1552		MJD350-1	3-577
2SA1562		MJD210-1	3-569
2SA1568		MJF2955	3-794
2SA1592		MJD32C1	3-542
2SA1593		MJD32C1	3-542
2SA489		TIP32C	3-873
2SA490		TIP32B	3-873
2SA496		2N4918	3-34
2SA505		2N4919	3-34
2SA623		2N4918	3-34
2SA624		2N4919	3-34
2SA626		MJ15016	3-5
2SA627		MJ15016	3-5
2SA633		2N4918	3-34
2SA634		2N4919	3-34
2SA635		2N4919	3-34
2SA636		2N4919	3-34
2SA645		MJE182	3-589
2SA646		2N4919	3-34
2SA647		2N4919	3-34
2SA648		MJ15002	3-497
2SA656		MJ15016	3-5
2SA657		MJ15016	3-5
2SA658		MJ15016	3-5
2SA663		MJ15016	3-5
2SA670		TIP32B	3-873
2SA671		TIP32B	3-873
2SA679		MJ15016	3-5
2SA680		2N5880	3-77
2SA681		MJE253	3-596
2SA682		MJE253	3-596
2SA698		MJE350	3-606
2SA699		2N4918	3-34
2SA700		TIP32B	3-873
2SA703		2N4918	3-34
2SA714		MJ15016	3-5
2SA715		MJE171	3-589
2SA738		MJE171	3-589
2SA755		TIP32B	3-873
2SA756		MJ15016	3-5
2SA757		MJ15016	3-5
2SA758		MJ15016	3-5
2SA768		TIP32B	3-873
2SA769		TIP32C	3-873
2SA770		2N6109	3-101
2SA771		2N6107	3-101

Industry Part Number	Motorola Nearest Replacement	Motorola Similar Replacement	Page Number
2SA775		TIP32C	3-873
2SA779		2N4918	3-34
2SA780		2N4919	3-34
2SA794		MJE253	3-596
2SA795		MJE253	3-596
2SA807		2N3792	3-25
2SA808		2N3792	3-25
2SA814		TIP32C	3-873
2SA815		TIP32C	3-873
2SA816		TIP32B	3-873
2SA818		MJE350	3-606
2SA835		MJE350	3-606
2SA837		MJ15016	3-5
2SA839		TIP32C	3-873
2SA843		MJE15031	3-684
2SA878		MJ15002	3-497
2SA882		MJ15002	3-497
2SA887		2N4919	3-34
2SA898		MJE350	3-606
2SA899		MJE350	3-606
2SA900		MJE210	3-592
2SA907		MJ15016	3-5
2SA908		MJ15002	3-497
2SA909		MJ15003	3-500
2SA922		2N4918	3-34
2SA939		MJE350	3-606
2SA940		MJE15031	3-684
2SA949		MJE15031	3-684
2SA957		MJE15031	3-684
2SA958		MJE15031	3-684
2SA963		MJE171	3-589
2SA965		MJE15029	3-684
2SA966		TIP32B	3-873
2SA968		MJE15031	3-684
2SA969		MJE15031	3-684
2SA971		2N6609	3-21
2SA980		2N5880	3-77
2SA981		MJ15002	3-497
2SA982		MJ15002	3-497
2SB1020		2N6042	3-89
2SB1022		2N6041	3-89
2SB1024		TIP127	3-900
2SB1047L		MJD117-1	3-558
2SB1047S		MJD117	3-558
2SB1072L		MJD6036-1	3-584
2SB1072S		MJD6036	3-584
2SB1179		MJD6036-1	3-584
2SB1179A		MJD6036-1	3-584
2SB1180		MJD127-1	3-563
2SB1180A		MJD127-1	3-563
2SB1201		MJD45H11-1	3-550
2SB1202		MJD45H11-1	3-550
2SB1203		MJD45H11-1	3-550
2SB1204		MJD45H11-1	3-550
2SB1205		MJD210-1	3-569
2SB1214		MJD6036-1	3-584
2SB1215		MJD45H11-1	3-550
2SB1216		MJD45H11-1	3-550
2SB506		MJ15016	3-5
2SB507		TIP32B	3-873
2SB509		TIP32C	3-873
2SB511		TIP32B	3-873
2SB513		TIP32C	3-873

INDEX AND CROSS REFERENCE (continued)

Industry Part Number	Motorola Nearest Replacement	Motorola Similar Replacement	Page Number
2SB514		TIP32B	3-873
2SB515		TIP32B	3-873
2SB518		MJ15016	3-5
2SB519		MJ15016	3-5
2SB520		MJ15016	3-5
2SB521		TIP42B	3-883
2SB522		TIP42B	3-883
2SB523		2N5194	3-49
2SB524		2N5194	3-49
2SB526		2N4920	3-34
2SB527		2N4920	3-34
2SB528		2N4920	3-34
2SB529		2N5194	3-49
2SB530		MJ15002	3-497
2SB531		MJ15016	3-5
2SB532		MJ15016	3-5
2SB536		TIP32C	3-873
2SB537		TIP32C	3-873
2SB539		MJ15002	3-497
2SB541		MJ15002	3-497
2SB546		MJE15031	3-684
2SB546		MJE15031	3-684
2SB547		MJE15031	3-684
2SB548		2N4920	3-34
2SB549		2N4920	3-34
2SB552		MJ15025	3-509
2SB553		2N6107	3-101
2SB554		MJ15025	3-509
2SB555		MJ15012	3-502
2SB556		MJ15012	3-502
2SB557		MJ15002	3-497
2SB558		2N5880	3-77
2SB559		2N4918	3-34
2SB565		TIP32B	3-873
2SB566		TIP32C	3-873
2SB567		MJE15031	3-684
2SB568		MJE15031	3-684
2SB569		2N6035	3-85
2SB570		2N6035	3-85
2SB571		2N6036	3-85
2SB572		2N5194	3-49
2SB573		2N5194	3-49
2SB574		2N5195	3-49
2SB575		2N5194	3-49
2SB576		2N5194	3-49
2SB577		2N5195	3-49
2SB578		MJE2955T	3-628
2SB579		MJE2955T	3-628
2SB580		MJE2955T	3-628
2SB581		MJE2955T	3-628
2SB582		2N6041	3-89
2SB583		2N6041	3-89
2SB584		2N6041	3-89
2SB587		2N6052	3-93
2SB588		2N6052	3-93
2SB589		2N6052	3-93
2SB595		TIP42C	3-883
2SB596		TIP32C	3-873
2SB600		MJ15012	3-502
2SB604		TIP32C	3-873
2SB628		MJE15031	3-684
2SB630		MJE15031	3-684
2SB631		2N4920	3-34

Industry Part Number	Motorola Nearest Replacement	Motorola Similar Replacement	Page Number
2SB632		2N4918	3-34
2SB633		TIP42C	3-883
2SB648		MJE350	3-606
2SB649		MJE350	3-606
2SB653		MJ15016	3-5
2SB654		MJ15016	3-5
2SB655		MJ15002	3-497
2SB656		MJ15002	3-497
2SB668		TIP32B	3-873
2SB669		TIP32B	3-873
2SB673		2N6042	3-89
2SB674		2N6041	3-89
2SB675		2N6041	3-89
2SB676		TIP127	3-900
2SB677		TIP125	3-900
2SB679		TIP117	3-895
2SB681		MJ15002	3-497
2SB686		TIP42C	3-883
2SB688		MJE15029	3-684
2SB689		TIP42C	3-883
2SB690		TIP42C	3-883
2SB691		MJE4352	3-632
2SB692		MJE4352	3-632
2SB693		2N6287	3-112
2SB694		MJ11015	3-478
2SB695		MJE4352	3-632
2SB696		MJ15002	3-497
2SB697		MJ15002	3-497
2SB707		2N6107	3-101
2SB708		2N6107	3-101
2SB711		2N6041	3-89
2SB712		2N6042	3-89
2SB713		MJE4352	3-632
2SB717		MJE350	3-606
2SB718		MJE350	3-606
2SB719		MJE15031	3-684
2SB720		MJE15031	3-684
2SB722		MJ15002	3-497
2SB723		MJ15025	3-509
2SB724		TIP32B	3-873
2SB727		MJE15029	3-684
2SB743		MJE171	3-589
2SB744		MJE172	3-589
2SB750		TIP116	3-895
2SB751		TIP126	3-900
2SB753		TIP42C	3-883
2SB754		2N6109	3-101
2SB772		MJE171	3-589
2SB906		MJD32C1	3-542
2SB907		MJD6036-1	3-584
2SB908		MJD6036-1	3-584
2SB962		MJD45H11-1	3-550
2SB963		MJD117-1	3-558
2SB967		MJD210	3-569
2SB968		MJD210	3-569
2SC1004		BU208A	3-226
2SC1004A		BU208A	3-226
2SC1005		BU208A	3-226
2SC1013		MJE181	3-589
2SC1014		MJE181	3-589
2SC1025		2N6233	—
2SC1030		2N3442	3-9
2SC1034		BU208A	3-226

INDEX AND CROSS REFERENCE (continued)

Industry Part Number	Motorola Nearest Replacement	Motorola Similar Replacement	Page Number
2SC1036		BU208A	3-226
2SC1050		MJ423	3-419
2SC1051		2N3442	3-9
2SC1060		TIP31B	3-873
2SC1061		TIP31B	3-873
2SC1078		BU208A	3-226
2SC1079		MJ15001	3-497
2SC1080		MJ15001	3-497
2SC1086		BU208A	3-226
2SC1088		MJE3439	3-630
2SC1089		MJE3439	3-630
2SC1096		MJE181	3-589
2SC1098		2N4923	3-38
2SC1099		BU208A	3-226
2SC1100		BU208A	3-226
2SC1101		BU208A	3-226
2SC1107		TIP31B	3-873
2SC1108		TIP31B	3-873
2SC1109		TIP31B	3-873
2SC1110		TIP31B	3-873
2SC1111		MJ15001	3-497
2SC1112		MJ15001	3-497
2SC1113		MJE15030	3-684
2SC1115		MJ15001	3-497
2SC1116		MJ15011	3-502
2SC1132		BU208A	3-226
2SC1140		2N6547	3-140
2SC1141		2N6547	3-140
2SC1151		BU208A	3-226
2SC1153		BU208A	3-226
2SC1154		BU208A	3-226
2SC1155		MJE182	3-589
2SC1157		2N4923	3-38
2SC1162		MJE181	3-589
2SC1167		BU208A	3-226
2SC1170		BU208A	3-226
2SC1170A		BU208A	3-226
2SC1171		BU208A	3-226
2SC1172		BU208A	3-226
2SC1173		TIP31B	3-873
2SC1174		BU208A	3-226
2SC1184		BU208A	3-226
2SC1224		MJE341	3-604
2SC1226		MJE800	3-612
2SC1227		MJ10007	3-445
2SC1228		MJ16010	3-512
2SC1229		MJ10007	3-445
2SC1237		TIP31B	3-873
2SC1243		MJE800	3-612
2SC1295		BU208A	3-226
2SC1309		BU208A	3-226
2SC1322		BUV23	3-388
2SC1325		MJ16018	3-520
2SC1343		MJ15011	3-502
2SC1348		BU208A	3-226
2SC1358		BU208A	3-226
2SC1367		BU208A	3-226
2SC1381		MJE182	3-589
2SC1382		MJE182	3-589
2SC1402		MJ15001	3-497
2SC1403		MJ15001	3-497
2SC1409		TIP47	3-887
2SC1410		TIP47	3-887

Industry Part Number	Motorola Nearest Replacement	Motorola Similar Replacement	Page Number
2SC1413		BU208A	3-226
2SC1418		TIP31B	3-873
2SC1419		TIP31B	3-873
2SC1433		MJ423	3-419
2SC1434		2N6547	3-140
2SC1436		BUV23	3-388
2SC1440		MJ15001	3-497
2SC1441		BUV23	3-388
2SC1447		TIP47	3-887
2SC1448		TIP47	3-887
2SC1449		MJE181	3-589
2SC1454		MJ423	3-419
2SC1468		MJ16010	3-512
2SC1469		MJ16010	3-512
2SC1477		MJ10007	3-445
2SC1501		MJE3439	3-630
2SC1505		TIP48	3-887
2SC1506		TIP48	3-887
2SC1507		TIP48	3-887
2SC1514		MJE3439	3-630
2SC1516		2N6038	3-85
2SC1517		2N4922	3-38
2SC1519		MJE340	3-602
2SC1520		MJE340	3-602
2SC1521		MJE340	3-602
2SC1576		MJ16010	3-512
2SC1577		MJ16010	3-512
2SC1584		BUV23	3-388
2SC1585		BUV23	3-388
2SC1586		BUV23	3-388
2SC1609		2N6341	3-117
2SC1610		2N6341	3-117
2SC1617		MJ423	3-419
2SC1629		MJ1001	3-423
2SC1669		TIP47	3-887
2SC1672		2N6341	3-117
2SC1683		TIP47	3-887
2SC1722		TIP48	3-887
2SC1723		TIP48	3-887
2SC1749		MJE340	3-602
2SC1755		MJE2360T	3-626
2SC1756		MJE2360T	3-626
2SC1757		MJE2360T	3-626
2SC1777		2N5882	3-77
2SC1782		MJ15001	3-497
2SC1783		BUV23	3-388
2SC1784		MJ15001	3-497
2SC1785		BUV23	3-388
2SC1786		BUV23	3-388
2SC1818		2N6341	3-117
2SC1819		MJE2361T	3-626
2SC1826		TIP41B	3-883
2SC1827		TIP41C	3-883
2SC1830		2N6578	3-144
2SC1831		2N6056	3-97
2SC1832		MJ10009	3-451
2SC1846		MJE181	3-589
2SC1847		MJE181	3-589
2SC1848		MJE182	3-589
2SC1866		2N3442	3-9
2SC1868		MJ16010	3-512
2SC1869		MJ15001	3-497
2SC1870		2N6547	3-140

INDEX AND CROSS REFERENCE (continued)

Industry Part Number	Motorola Nearest Replacement	Motorola Similar Replacement	Page Number
2SC1875		BU208A	3-226
2SC1880		TIP112	3-895
2SC1881		TIP111	3-895
2SC1883		TIP122	3-900
2SC1891		BU208A	3-226
2SC1892		BU208A	3-226
2SC1893		BU208A	3-226
2SC1894		BU208A	3-226
2SC1895		MJ16018	3-520
2SC1896		MJ16018	3-520
2SC1903		MJE341	3-604
2SC1904		MJE341	3-604
2SC1905		MJE2361T	3-626
2SC1922		BU208A	3-226
2SC1929		TIP48	3-887
2SC1942		BU208A	3-226
2SC1943		TIP111	3-895
2SC1944		TIP112	3-895
2SC1945		TIP41B	3-883
2SC1948		TIP41C	3-883
2SC1983		TIP111	3-895
2SC1984		TIP112	3-895
2SC1985		TIP41B	3-883
2SC1986		TIP41C	3-883
2SC2024		2N4923	3-38
2SC2027		MJ16018	3-520
2SC2068		MJE340	3-602
2SC2071		MJE3439	3-630
2SC2073		TIP47	3-887
2SC2080		MJE181	3-589
2SC2085		MJE2361T	3-626
2SC2121		MJ423	3-419
2SC2122		MJ423	3-419
2SC2126		MJE13005	3-661
2SC2127		BUV23	3-388
2SC2128		MJ10015	3-461
2SC2138		MJ16010	3-512
2SC2139		MJ16010	3-512
2SC2140		MJ16010	3-512
2SC2147		MJ10015	3-461
2SC2148		MJ16010	3-512
2SC2159		MJ10015	3-461
2SC2167		MJE15030	3-684
2SC2168		MJE15030	3-684
2SC2169		MJ15001	3-497
2SC2190		BUX48A	3-401
2SC2191		2N6547	3-140
2SC2204		MJ10016	3-461
2SC2209		MJE181	3-589
2SC2220		MJ10016	3-461
2SC2229		TIP47	3-887
2SC2230		TIP47	3-887
2SC2233		2N6497	3-136
2SC2235		TIP47	3-887
2SC2236		TIP31B	3-873
2SC2238		TIP47	3-887
2SC2242		MJE2361T	3-626
2SC2244		BUX48A	3-401
2SC2245		MJ16010	3-512
2SC2246		2N6547	3-140
2SC2248		BUX48A	3-401
2SC2249		MJ10015	3-461
2SC2250		MJ10016	3-461

Industry Part Number	Motorola Nearest Replacement	Motorola Similar Replacement	Page Number
2SC2256		BUV23	3-388
2SC2260		BUV23	3-388
2SC2261		BUV23	3-388
2SC2262		BUV23	3-388
2SC2270		2N5194	3-49
2SC2278		MJE3439	3-630
2SC2292		MJ16010	3-512
2SC2293		MJ16010	3-512
2SC2298		MJE270	3-600
2SC2311		2N4922	3-38
2SC2321		MJ15001	3-497
2SC2322		MJ15015	3-5
2SC2323		MJ15001	3-497
2SC2324		2N6038	3-85
2SC2331		MJE13005	3-661
2SC2333		MJE13005	3-661
2SC2334		MJE15030	3-684
2SC2335		MJE13007	3-667
2SC2337		MJ15001	3-497
2SC2344		TIP47	3-887
2SC2356		2N6547	3-140
2SC2366		MJ10016	3-461
2SC2371		MJE3439	3-630
2SC2373		MJE13007	3-667
2SC2397		MJE3055T	3-628
2SC240		2N3055A	3-5
2SC2402		2SC2402	3-140
2SC2403		MJ10015	3-461
2SC242		2N3055A	3-5
2SC2428		BUV23	3-388
2SC2429		MJ16010	3-512
2SC243		MJ410	3-417
2SC2430		MJ15001	3-497
2SC2431		MJ15015	3-5
2SC2432		2N5882	3-77
2SC2433		MJ11016	3-478
2SC2434		2N6328	—
2SC2435		2N6059	3-93
2SC2436		2N6059	3-93
2SC2442		MJ10016	3-461
2SC2443		MJ10016	3-461
2SC2448		MJ16010	3-512
2SC2449		MJ16010	3-512
2SC245		2N3055A	3-5
2SC2450		MJ16010	3-512
2SC2451		MJ16010	3-512
2SC2452		MJ16010	3-512
2SC2453		MJ16010	3-512
2SC246		MJ410	3-417
2SC2482		MJE2361T	3-626
2SC2487		MJ15001	3-497
2SC2488		MJ15001	3-497
2SC2489		MJ15001	3-497
2SC2492		MJ15001	3-497
2SC2493		MJ15001	3-497
2SC2500		TIP31B	3-873
2SC2516		2N6497	3-136
2SC2534		MJE13003	3-655
2SC2535		MJE13005	3-661
2SC2536		MJE13005	3-661
2SC2541		MJ16010	3-512
2SC2555		MJW16206	3-855
2SC2562		TIP42B	3-883

INDEX AND CROSS REFERENCE (continued)

Industry Part Number	Motorola Nearest Replacement	Motorola Similar Replacement	Page Number
2SC2569		2N3442	3-9
2SC2590		MJE341	3-604
2SC270		MJ423	3-419
2SC2792		MJE1320	3-620
2SC2870L		MJD340-1	3-577
2SC2870S		MJD340	3-577
2SC2871L		MJD112-1	3-558
2SC2871S		MJD112	3-558
2SC2873		MJD31C	3-542
2SC2881		MJD47	3-554
2SC2882		MJD31C	3-542
2SC2884		MJD31	3-542
2SC2924		MJD340	3-577
2SC2982		MJD31	3-542
2SC3074		MJD41C	3-546
2SC3076		MJD31C	3-542
2SC3132L		MJD6039-1	3-584
2SC3132S		MJD6039	3-584
2SC3148		MJW16018	3-520
2SC3257		MJE13009	3-676
2SC3281	MJL3281A		3-843
2SC3294		TIP41B	3-883
2SC3306		MJE13009	3-676
2SC3307		MJW16018	3-520
2SC3309		BUX48	3-401
2SC3310		MJE16002	3-688
2SC3346		MJE13009	3-676
2SC3386L		MJD44H11-1	3-550
2SC3386S		MJD44H11	3-550
2SC3405		MJE1320	3-620
2SC3419		TIP31B	3-873
2SC3420		TIP41B	3-883
2SC3421		TIP47	3-887
2SC3425		TIP50	3-887
2SC3474		MJD112	3-558
2SC3540		MJE15028	3-684
2SC3559		MJW16018	3-520
2SC3621		MJE13005	3-661
2SC4027		MJD340-1	3-577
2SC4028		MJW16018	3-520
2SC4053		MJE18004	3-715
2SC4065		MJF3055	3-794
2SC407		MJ15011	3-502
2SC408		MJ15011	3-502
2SC409		BUV23	3-388
2SC41		MJ410	3-417
2SC410		BUV23	3-388
2SC411		2N6547	3-140
2SC412		2N6547	3-140
2SC4134		MJD31C1	3-542
2SC4135		MJD31C1	3-542
2SC42		MJ410	3-417
2SC42A		MJ410	3-417
2SC43		2N3055A	3-5
2SC431		2N6341	3-117
2SC432		2N6341	3-117
2SC433		MJ15024	3-506
2SC434		MJ15024	3-506
2SC435		MJ10000	3-433
2SC436		MJ10000	3-433
2SC44		2N3055A	3-5
2SC492		2N3055A	3-5
2SC493		2N3055A	3-5

Industry Part Number	Motorola Nearest Replacement	Motorola Similar Replacement	Page Number
2SC495		2N4923	3-38
2SC496		2N4921	3-38
2SC518		2N3716	3-12
2SC518A		2N3716	3-12
2SC519		2N3055A	3-5
2SC520		2N3716	3-12
2SC520A		2N3716	3-12
2SC521A		2N3716	3-12
2SC558		BUX48A	3-401
2SC586		MJ410	3-417
2SC642		BU208A	3-226
2SC643		BU208A	3-226
2SC647		2N3716	3-12
2SC665		2N3442	3-9
2SC681		MJ15011	3-502
2SC687		MJ410	3-417
2SC736		2N3055A	3-5
2SC768		2N3055	3-2
2SC769		MJ15001	3-497
2SC770		MJ15011	3-502
2SC771		MJ15011	3-502
2SC789		TIP31B	3-873
2SC790		TIP31B	3-873
2SC806		MJ423	3-419
2SC807		MJ413	3-419
2SC808		MJ423	3-419
2SC861		BUX48A	3-401
2SC862		BUX48A	3-401
2SC887		MJ410	3-417
2SC888		MJ410	3-417
2SC889		MJ410	3-417
2SC902		MJ15001	3-497
2SC931		MJE3055T	3-628
2SC932		MJE3055T	3-628
2SC936		BU208A	3-226
2SC937		BU208A	3-226
2SC939		MJ15001	3-497
2SC940		BUV23	3-388
2SC961		2N3055A	3-5
2SC999		BU208A	3-226
2SD041		2N3716	3-12
2SD107		2N6056	3-97
2SD1077L		MJD31-1	3-542
2SD1077S		MJD31	3-542
2SD108		2N6056	3-97
2SD1080L		MJD47-1	3-554
2SD1080S		MJD47	3-554
2SD1081L		MJD47-1	3-554
2SD1081S		MJD47	3-554
2SD110		MJ15001	3-497
2SD111		2N5882	3-77
2SD1112		MJD340	3-577
2SD113		MJ802	3-421
2SD114		2N5686	3-66
2SD1164		MJD112-1	3-558
2SD117		2N3442	3-9
2SD1178		MJD112-1	3-558
2SD1178A		MJD112-1	3-558
2SD118		2N3442	3-9
2SD1187		TIP33C	3-877
2SD1222		MJD6039	3-584
2SD126		2N3442	3-9
2SD1281L		MJD44H11-1	3-550

INDEX AND CROSS REFERENCE (continued)

Industry Part Number	Motorola Nearest Replacement	Motorola Similar Replacement	Page Number
2SD1281S		MJD44H11	3-550
2SD1295		MJD200	3-569
2SD133		2N6338	3-117
2SD1412		2N6292	3-101
2SD1413		MJE800T	3-612
2SD1414		TIP122	3-900
2SD1415		TIP120	3-900
2SD1417		TIP101	3-891
2SD1465L		MJD112-1	3-558
2SD1465S		MJD112	3-558
2SD1520L		MJD6039-1	3-584
2SD1520S		MJD6039	3-584
2SD1590		MFJ6388	—
2SD161		MJ15001	3-497
2SD163		2N3716	3-12
2SD164		2N5882	3-77
2SD165		MJ15001	3-497
2SD166		MJ15011	3-502
2SD168		MJ3001	3-425
2SD17		2N3442	3-9
2SD172		2N5878	3-74
2SD173		2N5882	3-77
2SD174		2N5878	3-74
2SD1748		MJD112-1	3-558
2SD1748A		MJD112-1	3-558
2SD1749		MJD6039-1	3-584
2SD1749A		MJD6039-1	3-584
2SD175		2N5882	3-77
2SD176		2N5882	3-77
2SD177		MJ15001	3-497
2SD1799		MJD6039-1	3-584
2SD18		MJ15011	3-502
2SD1800		MJD112-1	3-558
2SD1801		MJD44H11-1	3-550
2SD1802		MJD44H11-1	3-550
2SD1803		MJD44H11-1	3-550
2SD1804		MJD44H11-1	3-550
2SD1805		MJD44H11-1	3-550
2SD181		MJ15001	3-497
2SD1815		MJD44H11-1	3-550
2SD1816		MJD44H11-1	3-550
2SD1817		MJD6039-1	3-584
2SD199		BU208A	3-226
2SD200		BU208A	3-226
2SD202		2N3055A	3-5
2SD203		2N3442	3-9
2SD206		2N5878	3-74
2SD207		2N5882	3-77
2SD208		MJ15001	3-497
2SD211		2N5878	3-74
2SD212		2N5882	3-77
2SD213		MJ15001	3-497
2SD214		MJ15001	3-497
2SD217		MJ15001	3-497
2SD218		MJ15001	3-497
2SD231		2N5302	3-54
2SD232		2N6275	3-108
2SD233		TIP31B	3-873
2SD235		TIP31B	3-873
2SD243		MJE15030	3-684
2SD244		MJE15030	3-684
2SD246		BU208A	3-226
2SD249		2N5302	3-54

Industry Part Number	Motorola Nearest Replacement	Motorola Similar Replacement	Page Number
2SD250		2N6328	—
2SD258		MJE15030	3-684
2SD259		MJE15030	3-684
2SD262		2N6547	3-140
2SD265		BUX48A	3-401
2SD266		BUX48A	3-401
2SD26C		2N3442	3-9
2SD271		MJE13005	3-661
2SD272		MJE13005	3-661
2SD273		BUX48A	3-401
2SD274		BUX48A	3-401
2SD283		MJE15030	3-684
2SD284		MJE15030	3-684
2SD285		MJE15030	3-684
2SD286		MJ15011	3-502
2SD287		MJ15011	3-502
2SD288		TIP31B	3-873
2SD289		TIP31B	3-873
2SD293		2N6547	3-140
2SD294		2N6547	3-140
2SD297		MJE15030	3-684
2SD299		BU208A	3-226
2SD300		BU208A	3-226
2SD301		MJ3001	3-425
2SD310		2N6547	3-140
2SD311		2N6547	3-140
2SD313		TIP31B	3-873
2SD314		TIP31B	3-873
2SD317		TIP31B	3-873
2SD318		TIP31B	3-873
2SD319		MJ15001	3-497
2SD322		MJ15011	3-502
2SD323		MJ15011	3-502
2SD325		TIP31B	3-873
2SD330		TIP31B	3-873
2SD331		TIP31B	3-873
2SD334		2N3055A	3-5
2SD340		MJ15015	3-5
2SD341		MJ15015	3-5
2SD342		TIP31B	3-873
2SD343		TIP31B	3-873
2SD344		TIP31B	3-873
2SD345		TIP31B	3-873
2SD347		TIP41B	3-883
2SD348		MJ16018	3-520
2SD350		BU208A	3-226
2SD351		BUX48A	3-401
2SD356		2N4923	3-38
2SD357		2N4923	3-38
2SD358		2N4923	3-38
2SD359		2N5191	3-44
2SD360		2N5191	3-44
2SD361		2N5191	3-44
2SD363		MJ10015	3-461
2SD364		MJ10016	3-461
2SD365		TIP31B	3-873
2SD366		TIP31B	3-873
2SD368		MJ16018	3-520
2SD369		2N3716	3-12
2SD372		MJ10015	3-461
2SD373		MJ10015	3-461
2SD374		MJ10016	3-461
2SD375		BUV23	3-388

INDEX AND CROSS REFERENCE (continued)

Industry Part Number	Motorola Nearest Replacement	Motorola Similar Replacement	Page Number
2SD376		BUV23	3-388
2SD380		MJ16018	3-520
2SD381		MJE15030	3-684
2SD382		MJE15030	3-684
2SD383		MJ423	3-419
2SD386		MJE13005	3-661
2SD387		MJE13005	3-661
2SD388		MJ15011	3-502
2SD389		TIP31B	3-873
2SD390		TIP31B	3-873
2SD393		MJ16010	3-512
2SD394		MJ16010	3-512
2SD395		MJ16010	3-512
2SD396		2N6547	3-140
2SD401		TIP47	3-887
2SD402		TIP47	3-887
2SD404		TIP120	3-900
2SD414		MJE341	3-604
2SD415		MJE341	3-604
2SD416		MJ16018	3-520
2SD418		MJ16018	3-520
2SD422		MJE13005	3-661
2SD423		MJE13005	3-661
2SD424		MJ15001	3-497
2SD425		MJ15001	3-497
2SD426		MJ15001	3-497
2SD427		2N3055A	3-5
2SD429		2N6547	3-140
2SD430		2N3055A	3-5
2SD431		MJ15001	3-497
2SD432		MJ15001	3-497
2SD433		MJ15011	3-502
2SD434		BUV23	3-388
2SD435		MJ13333	3-487
2SD436		MJ13333	3-487
2SD437		MJ16010	3-512
2SD45		2N3442	3-9
2SD457		MJ10015	3-461
2SD458		MJ16010	3-512
2SD459		TIP121	3-900
2SD46		2N3442	3-9
2SD460		TIP122	3-900
2SD461		MJ423	3-419
2SD463		2N6056	3-97
2SD464		2N6056	3-97
2SD475		TIP31B	3-873
2SD476		TIP31B	3-873
2SD478		TIP47	3-887
2SD479		2N6038	3-85
2SD480		2N6038	3-85
2SD481		2N6039	3-85
2SD482		2N5657	3-63
2SD483		2N5657	3-63
2SD484		2N5657	3-63
2SD485		2N5191	3-44
2SD486		2N5191	3-44
2SD487		2N5192	3-44
2SD488		2N4921	3-38
2SD489		2N4922	3-38
2SD490		2N4923	3-38
2SD491		MJE3055T	3-628
2SD492		2N3055	3-2
2SD493		MJE3055T	3-628

Industry Part Number	Motorola Nearest Replacement	Motorola Similar Replacement	Page Number
2SD494		MJE3055T	3-628
2SD495		MJE3055T	3-628
2SD496		2N6044	3-89
2SD497		2N6044	3-89
2SD498		2N6045	3-89
2SD499		MJE3055T	3-628
2SD500		MJE3055T	3-628
2SD501		2N6488	3-132
2SD502		2N6056	3-97
2SD503		2N6056	3-97
2SD504		2N6059	3-93
2SD505		2N6059	3-93
2SD506		2N6059	3-93
2SD517		BU208A	3-226
2SD518		MJE13005	3-661
2SD522		2N5882	3-77
2SD523		2N6056	3-97
2SD524		2N6056	3-97
2SD525		TIP41C	3-883
2SD526		TIP41B	3-883
2SD53		2N3055A	3-5
2SD531		TIP41C	3-883
2SD533		MJ423	3-419
2SD538		MJ16010	3-512
2SD544		TIP41C	3-883
2SD549		TIP111	3-895
2SD55		2N6328	—
2SD552		BUV23	3-388
2SD553		TIP41B	3-883
2SD570		TIP31B	3-873
2SD574		MJ11016	3-478
2SD577		BU208A	3-226
2SD589		MJ16018	3-520
2SD598		2N3055A	3-5
2SD60		2N3442	3-9
2SD600		2N4923	3-38
2SD605		MJ10012	3-457
2SD608		TIP47	3-887
2SD610		TIP47	3-887
2SD612		MJE521	3-610
2SD613		TIP41C	3-883
2SD622		MJE13005	3-661
2SD626		MJ10012	3-457
2SD627		BU208A	3-226
2SD628		2N6059	3-93
2SD629		2N6059	3-93
2SD630		2N5302	3-54
2SD631		2N5302	3-54
2SD633		TIP122	3-900
2SD634		TIP121	3-900
2SD635		TIP120	3-900
2SD640		BUX48A	3-401
2SD642		MJ10016	3-461
2SD643		MJ10015	3-461
2SD644		MJ10016	3-461
2SD645		MJ10016	3-461
2SD646		MJ10016	3-461
2SD649		BU208A	3-226
2SD650		MJ10012	3-457
2SD663		MJ10012	3-457
2SD665		BUV23	3-388
2SD668		MJE344	3-604
2SD669		MJE344	3-604

INDEX AND CROSS REFERENCE (continued)

Industry Part Number	Motorola Nearest Replacement	Motorola Similar Replacement	Page Number
2SD67		2N3055A	3-5
2SD670		2N6578	3-144
2SD673		2N3055A	3-5
2SD674		2N3055A	3-5
2SD675		2N3442	3-9
2SD676		2N3442	3-9
2SD678		TIP111	3-895
2SD679		TIP111	3-895
2SD686		TIP122	3-900
2SD687		MJE800T	3-612
2SD689		TIP112	3-895
2SD69		2N3442	3-9
2SD692		2N6056	3-97
2SD693		MJ10012	3-457
2SD694		MJ10015	3-461
2SD695		MJ10015	3-461
2SD696		MJ10015	3-461
2SD702		MJ10015	3-461
2SD703		MJ10016	3-461
2SD705		MJ10012	3-457
2SD710		MJ10005	3-439
2SD716		TIP41C	3-883
2SD717		D44H10	3-411
2SD718		MJE15028	3-684
2SD721		2N6045	3-89
2SD722		2N6045	3-89
2SD723		TIP31C	3-873
2SD724		MJE13005	3-661
2SD725		MJ16018	3-520
2SD726		TIP31C	3-873
2SD727		2N3055A	3-5
2SD728		2N3442	3-9
2SD729		2N6284	3-112
2SD733		MJ15001	3-497
2SD74		2N3442	3-9
2SD751		MJ423	3-419
2SD752		MJ15001	3-497
2SD753		BUV23	3-388
2SD757		MJE3439	3-630
2SD758		MJE3439	3-630
2SD759		TIP47	3-887
2SD760		TIP47	3-887
2SD761		TIP47	3-887
2SD762		TIP31B	3-873
2SD764		BU208A	3-226
2SD765		BU208A	3-226
2SD768		2N6045	3-89
2SD793		MJE181	3-589
2SD794		MJE182	3-589
2SD797		MJE802	3-612
2SD801		BUX48A	3-401
2SD802		BUX48A	3-401
2SD803		2N6059	3-93
2SD805		MJ10016	3-461
2SD823		MJE15030	3-684
2SD83		2N3442	3-9
2SD836		TIP111	3-895
2SD837		TIP120	3-900
2SD839		MJE800T	3-612
2SD84		MJ15011	3-502
2SD840		TIP121	3-900
2SD843		MJE15028	3-684
2SD844		MJE3055T	3-628

Industry Part Number	Motorola Nearest Replacement	Motorola Similar Replacement	Page Number
2SD867		MJ15001	3-497
2SD872		MJE3055T	3-628
2SD873		2N3773	3-21
2SD878		2N3055	3-2
2SD88		2N5758	3-70
2SD880		TIP31B	3-873
2SD882		MJE181	3-589
2SD903		MJ16018	3-520
2SD950		BU208A	3-226
2SD951		BU208A	3-226
2SD952		BU208A	3-226
2SD953		MJ16018	3-520
2SD992		MJD31-1	3-542
BD127		MJE340	3-602
BD128		MJE340	3-602
BD129		MJE340	3-602
BD130		2N3055	3-2
BD131		BD787	3-194
BD132		BD788	3-194
BD132		BD788	3-194
BD133		BD787	3-194
BD135	BD135		3-158
BD135.10		BD135	3-158
BD135.16		BD135	3-158
BD135.6		BD135	3-158
BD136	BD136		3-160
BD136.10		BD136	3-160
BD136.16		BD136	3-160
BD136.6		BD136	3-160
BD137	BD137		3-158
BD137.10		BD137	3-158
BD137.16		BD137	3-158
BD137.6		MJE181	3-589
BD138	BD138		3-160
BD138.10		BD138	3-160
BD138.16		BD138	3-160
BD138.6		BD138	3-160
BD139	BD139		3-158
BD139.10		BD139	3-158
BD139.16		BD139	3-158
BD139.6		BD139	3-158
BD140	BD140		3-160
BD140.10	BD140.10		3-160
BD140.16		BD140	3-160
BD140.6		BD140	3-160
BD157		MJE340	3-602
BD158		MJE340	3-602
BD159		MJE340	3-602
BD165		2N4921	3-38
BD166		2N4918	3-34
BD167		2N4922	3-38
BD168		2N4919	3-34
BD169		2N4923	3-38
BD170		2N4920	3-34
BD175		2N4923	3-38
BD175.10		2N4923	3-38
BD175.16		2N4923	3-38
BD175.6		2N4923	3-38
BD176	BD180		3-170
BD176.10		BD180	3-170
BD176.16		BD180	3-170
BD176.6		BD180	3-170
BD177		BD179	3-168

INDEX AND CROSS REFERENCE (continued)

Industry Part Number	Motorola Nearest Replacement	Motorola Similar Replacement	Page Number
BD177.10		BD179	3-168
BD177.16		BD179	3-168
BD177.6		BD179	3-168
BD178		2N4919	3-34
BD178.10		BD180	3-170
BD178.16		BD180	3-170
BD178.6		BD180	3-170
BD179	BD179		3-168
BD179.10		BD179	3-168
BD179.16		BD179	3-168
BD179.6		BD179	3-168
BD180	BD180		3-170
BD180.10		BD180	3-170
BD180.16		BD180	3-170
BD180.6		BD180	3-170
BD185		BD787	3-194
BD186	BD186		—
BD187	BD187		—
BD188	BD188		—
BD189		BD787	3-194
BD190		BD788	3-194
BD195		MJE3055T	3-628
BD196		MJE2955T	3-628
BD197		MJE3055T	3-628
BD198		MJE2955T	3-628
BD199		MJE3055T	3-628
BD200		MJE2955T	3-628
BD202	BD796		—
BD206		MJE2955T	3-628
BD207		MJE3055T	3-628
BD208		MJE2955T	3-628
BD220	BD537		—
BD223	BD538		—
BD226	BD135		3-158
BD227	BD136		3-160
BD228	BD137		3-158
BD229	BD138		3-160
BD230	BD139		3-158
BD231	BD140		3-160
BD232		BD159	3-162
BD237	BD237	2N4923	3-172
BD238		2N4920	3-34
BD240C		TIP32C	3-873
BD241	BD241B		3-174
BD241A	BD241B		3-174
BD241B	BD241B		3-174
BD241C	BD241C		3-174
BD242	BD242B		3-174
BD242A	BD242B		3-174
BD242B	BD242B		3-174
BD242C	BD242C		3-174
BD243	BD243B		3-178
BD243A	BD243B		3-178
BD243B	BD243B		3-178
BD243C	BD243C		3-178
BD244	BD244B		3-178
BD244A	BD244B		3-178
BD244B	BD244B		3-178
BD244C	BD244C		3-178
BD249C	BD249C		—
BD250C	BD250C		—
BD262	BD678		3-190
BD262A	BD680		3-190

Industry Part Number	Motorola Nearest Replacement	Motorola Similar Replacement	Page Number
BD262B	BD682		3-190
BD263	BD677		3-188
BD263A	BD679		3-188
BD263B	BD681		3-188
BD268A	BDW46		3-212
BD275	BD537		—
BD276	BD538		—
BD278	MJE3055T		3-628
BD278A	MJE3055T		3-628
BD279		2N6035	3-85
BD291	BD243B		3-178
BD292	BD244B		3-178
BD293	BD243B		3-178
BD294	BD244B		3-178
BD295	BD243B		3-178
BD296	BD244B		3-178
BD306A	BD787		3-194
BD306B	BD787		3-194
BD307A	BD787		3-194
BD307B	BD787		3-194
BD311		2N3716	3-12
BD312		2N3792	3-25
BD329	MJE200		3-592
BD330	MJE210		3-592
BD337	BDX33D		—
BD338	BDX34D		—
BD342	2N3055		3-2
BD343		MJE2955T	3-628
BD344	BD138		3-160
BD345	BD137		3-158
BD348	BD140		3-160
BD349	BD139		3-158
BD361	MJE200		3-592
BD361A	MJE200		3-592
BD362	MJE210		3-592
BD362A	MJE210		3-592
BD375	BD787		3-194
BD376	BD788		3-194
BD377	BD787		3-194
BD378	BD788		3-194
BD379	BD789		3-198
BD380	BD790		3-198
BD385		MJE181	3-589
BD385-1		MJE181	3-589
BD385-2		MJE181	3-589
BD385-5		MJE181	3-589
BD385-8		MJE181	3-589
BD386		MJE171	3-589
BD386-1		MJE171	3-589
BD386-2		MJE171	3-589
BD386-5		MJE171	3-589
BD386-8		MJE171	3-589
BD387		MJE182	3-589
BD387-1		MJE182	3-589
BD387-2		MJE182	3-589
BD387-5		MJE182	3-589
BD387-8		MJE182	3-589
BD388		MJE172	3-589
BD388-1		MJE172	3-589
BD388-2		MJE172	3-589
BD388-5		MJE172	3-589
BD388-8		MJE172	3-589
BD389		MJE243	3-596

INDEX AND CROSS REFERENCE (continued)

Industry Part Number	Motorola Nearest Replacement	Motorola Similar Replacement	Page Number
BD389-1		MJE243	3-596
BD389-2		MJE243	3-596
BD389-5		MJE243	3-596
BD389-8		MJE243	3-596
BD390		MJE253	3-596
BD390-1		MJE253	3-596
BD390-2		MJE253	3-596
BD390-5		MJE253	3-596
BD390-8		MJE253	3-596
BD410		MJE340	3-602
BD411		2N6038	3-85
BD411-1		2N6038	3-85
BD411-2		2N6038	3-85
BD411-5		2N6038	3-85
BD411-8		2N6038	3-85
BD412		2N6038	3-85
BD412-1		2N6038	3-85
BD412-2		2N6038	3-85
BD412-5		2N6038	3-85
BD412-8		2N6038	3-85
BD413		2N6035	3-85
BD413-1		2N6035	3-85
BD413-2		2N6035	3-85
BD413-5		2N6035	3-85
BD413-8		2N6035	3-85
BD414		2N6035	3-85
BD414-1		2N6035	3-85
BD414-2		2N6035	3-85
BD414-5		2N6035	3-85
BD414-8		2N6035	3-85
BD415		MJE181	3-589
BD415-1		MJE181	3-589
BD415-2		MJE181	3-589
BD415-8		MJE181	3-589
BD416		MJE171	3-589
BD416-1		MJE171	3-589
BD416-2		MJE171	3-589
BD416-5		MJE171	3-589
BD417		MJE182	3-589
BD417-1		MJE182	3-589
BD417-2		MJE182	3-589
BD417-5		MJE182	3-589
BD417-8		MJE182	3-589
BD418		MJE172	3-589
BD418-1		MJE172	3-589
BD418-2		MJE172	3-589
BD418-5		MJE172	3-589
BD418-8		MJE172	3-589
BD419		MJE243	3-596
BD419-1		MJE243	3-596
BD419-2		MJE243	3-596
BD419-8		MJE243	3-596
BD420		MJE253	3-596
BD420-1		MJE253	3-596
BD420-2		MJE253	3-596
BD420-5		MJE253	3-596
BD420-8		MJE253	3-596
BD424	BD791		3-198
BD429	MJE200		3-592
BD430	MJE210		3-592
BD433	BD437		3-182
BD434	BD438		3-185
BD435	BD437		3-182

Industry Part Number	Motorola Nearest Replacement	Motorola Similar Replacement	Page Number
BD436	BD438		3-185
BD438	BD438		3-185
BD440	BD440		3-185
BD442	BD442		3-185
BD443	BD179		3-168
BD443A	BD179		3-168
BD466A		2N6038	3-85
BD466B		2N6038	3-85
BD477A		2N6035	3-85
BD477B		2N6035	3-85
BD537		TIP31B	3-873
BD538		TIP32B	3-873
BD539	BD243B		3-178
BD539A	BD243B		3-178
BD539B	BD243B		3-178
BD539C	BD243C		3-178
BD540	BD244B		3-178
BD540A	BD244B		3-178
BD540B	BD244B		3-178
BD540C	BD244C		3-178
BD544	BD808		3-206
BD544A	BD808		3-206
BD544B	BD810		3-206
BD561	BD187		—
BD575	BD241B		3-174
BD576	BD242B		3-174
BD577	BD241B		3-174
BD578	BD242B		3-174
BD579	BD241B		3-174
BD580	BD242B		3-174
BD581	BD241C		3-174
BD582	BD242C		3-174
BD589	BD537		—
BD590	BD538		—
BD591	BD241C		3-174
BD592	BD242C		3-174
BD601	BD801		3-202
BD602	BD802		3-204
BD606	BD808		3-206
BD608	BD808		3-206
BD610	BD810		3-206
BD611	BD433		—
BD612	BD434		—
BD613	BD435		—
BD614	BD436		—
BD615	BD437		3-182
BD616	BD438		3-185
BD617	BD439		—
BD618	BD440		3-185
BD619	BD441		3-182
BD620	BD442		3-185
BD633	BD241B		3-174
BD634	BD242B		3-174
BD635	BD241B		3-174
BD636	BD242B		3-174
BD637	BD241B		3-174
BD638	BD242B		3-174
BD661	BD189		—
BD662	BD186		—
BD675	BD677		3-188
BD675A	BD677A		3-188
BD676	BD678		3-190
BD676A	BD678A		3-190

INDEX AND CROSS REFERENCE (continued)

Industry Part Number	Motorola Nearest Replacement	Motorola Similar Replacement	Page Number
BD677	BD677		3-188
BD677A	BD677A		3-188
BD678	BD678		3-190
BD678A	BD678A		3-190
BD679	BD679		3-188
BD679A	BD679A		3-188
BD680	BD680		3-190
BD680A	BD680A		3-190
BD681	BD681		3-188
BD682	BD682		3-190
BD743D		MJE15030	3-684
BD744	BD808		3-206
BD744A	BD808		3-206
BD744B	BD810		3-206
BD744D		MJE15031	3-684
BD775	BD777		3-192
BD776	BD776		3-192
BD777	BD777		3-192
BD778	BD778		3-192
BD780	BD780		3-192
BD785	BD787		3-194
BD786	BD788		3-194
BD787	BD787		3-194
BD788	BD788		3-194
BD789	BD789		3-198
BD790	BD790		3-198
BD791	BD791		3-198
BD792	BD792		3-198
BD801	BD801		3-202
BD802	BD802		3-204
BD806	BD808		3-206
BD808	BD808		3-206
BD809	BD810		3-206
BD810	BD810		3-206
BD813		MJE181	3-589
BD814		MJE171	3-589
BD815		MJE182	3-589
BD816		MJE172	3-589
BD817		MJE243	3-596
BD818		MJE253	3-596
BD825		MJE181	3-589
BD826		MJE171	3-589
BD827		MJE182	3-589
BD828		MJE172	3-589
BD829		MJE243	3-596
BD830		MJE253	3-596
BD833	BD787		3-194
BD834	BD788		3-194
BD835	BD787		3-194
BD836	BD788		3-194
BD837	BD789		3-198
BD838	BD790		3-198
BD839		BD790	3-198
BD861	BD677		3-188
BD862	BD678		3-190
BD863	BD677		3-188
BD864	BD678		3-190
BD865	BD679		3-188
BD866	BD680		3-190
BD875	BD775		—
BD876	BD776		3-192
BD877	BD777		3-192
BD878	BD778		3-192

Industry Part Number	Motorola Nearest Replacement	Motorola Similar Replacement	Page Number
BD880	BD780		3-192
BD905	2N6487		3-132
BD906	2N6490		3-132
BD907	2N6487		3-132
BD908	2N6490		3-132
BD909	2N6488		3-132
BD910	2N6491		3-132
BD933	BD241B		3-174
BD934	BD242B		3-174
BD935	BD241B		3-174
BD936	BD242B		3-174
BD937	BD241B		3-174
BD938	BD242B		3-174
BD939	BD241C		3-174
BD940	BD242C		3-174
BD941		MJE15030	3-684
BD942		MJE15031	3-684
BD951	BD537		—
BD952	BD538		—
BD953	BD241C		3-174
BD954	BD242C		3-174
BD955		MJE15030	3-684
BD956		MJE15031	3-684
BD957	BD775		—
BD977	BD777		3-192
BD978	BD778		3-192
BD980	BD780		3-192
BDT29	TIP31B		3-873
BDT29A		TIP32B	3-873
BDT29B		TIP31B	3-873
BDT29C		TIP31C	3-873
BDT30	TIP30A		—
BDT30B	TIP30B		3-871
BDT30C	TIP30C		3-871
BDT31	TIP31B		3-873
BDT31A	TIP31B		3-873
BDT31B	TIP31B		3-873
BDT31C	TIP31C		3-873
BDT32	TIP32B		3-873
BDT32A	TIP32B		3-873
BDT32B	TIP32B		3-873
BDT32C	TIP32C		3-873
BDT41	TIP41B		3-883
BDT41A	TIP41B		3-883
BDT41B	TIP41B		3-883
BDT41C	TIP41C		3-883
BDT42	TIP42B		3-883
BDT42A	TIP42B		3-883
BDT42B	TIP42B		3-883
BDT42C	TIP42C		3-883
BDT60	TIP125		3-900
BDT60A	TIP126		3-900
BDT60B	TIP127		3-900
BDT60C	BDX53D		—
BDT61	TIP120		3-900
BDT61A	TIP121		3-900
BDT61B	TIP122		3-900
BDT61C	BDX53D		—
BDT62A	BDW46		3-212
BDT62B	BDW47		3-212
BDT62C		BDW47	3-212
BDT63B	BDW42		3-212
BDT63C		BDW42	3-212

INDEX AND CROSS REFERENCE (continued)

Industry Part Number	Motorola Nearest Replacement	Motorola Similar Replacement	Page Number
BDT64B	BDW46		3-212
BDT64C	BDW47		3-212
BDT65B	BDW42		3-212
BDT65C		BDW42	3-212
BDT92	BD808		3-206
BDT94	BD810		3-206
BDV64	BDV64A		—
BDV64A	BDV64B		3-208
BDV64B	BDV64B		3-208
BDV64C		BDV64B	3-208
BDV65	BDV65A		—
BDV65A	BDV65B		3-208
BDV65B	BDV65B		3-208
BDV65C		BDV65B	3-208
BDV66C	MJH11018		3-825
BDV66D	MJH11019		3-825
BDV67D	MJH11020		3-825
BDV91	MJE3055T		3-628
BDV92	TIP34B		3-877
BDV93	TIP34C		3-877
BDV94	TIP2955		3-908
BDV95	TIP33B		3-877
BDV96	TIP33C		3-877
BDW21	2N3716		3-12
BDW21A	2N3716		3-12
BDW21B	2N3716		3-12
BDW21C		2N5882	3-77
BDW22	2N3792		3-25
BDW22B	2N3792		3-25
BDW22C	2N5880		3-77
BDW23	BDX53B		3-221
BDW23A	BDX53B		3-221
BDW23B	BDX53B		3-221
BDW23C	BDX53C		3-221
BDW24	BDX54B		3-221
BDW24A	BDX54B		3-221
BDW24B	BDX54B		3-221
BDW24C	BDX54C		3-221
BDW42	BDW42		3-212
BDW43		BDW42	3-212
BDW46	BDW46		3-212
BDW47	BDW47		3-212
BDW48		BDW47	3-212
BDW51	2N3716		3-12
BDW51A	2N3716		3-12
BDW51B	2N3716		3-12
BDW51C	2N5882		3-77
BDW52	2N3792		3-25
BDW52A	2N3792		3-25
BDW52B	2N3792		3-25
BDW52C	2N5880		3-77
BDW53	TIP120		3-900
BDW53A	TIP120		3-900
BDW53B	TIP121		3-900
BDW53C	BDX53C		3-221
BDW53D	BDX53D		—
BDW54	TIP125		3-900
BDW54A	TIP125		3-900
BDW54B	TIP126		3-900
BDW54C	BDX54C		3-221
BDW54D	BDX54D		—
BDW55	BD135		3-158
BDW56	BD136		3-160

Industry Part Number	Motorola Nearest Replacement	Motorola Similar Replacement	Page Number
BDW57	BD137		3-158
BDW58	BD138		3-160
BDW59	BD139		3-158
BDW60	BD140		3-160
BDW63	BDX53B		3-221
BDW63A	BDX53B		3-221
BDW63B	BDX53B		3-221
BDW63C	BDX53C		3-221
BDW63D	BDX53D		—
BDW64	BDX54B		3-221
BDW64A	BDX54B		3-221
BDW64B	BDX54B		3-221
BDW64C	BDX54C		3-221
BDW73D	BDX33D		—
BDW74D	BDX34D		—
BDW83	BDV65A		—
BDW83A	BDV65A		—
BDW83B	BDV65A		—
BDW83C	BDV65B		3-208
BDW84	BDV64A		—
BDW84A	BDV64A		—
BDW84B	BDV64A		—
BDW84C	BDV64B		3-208
BDW93C	BDW42		3-212
BDW94B	BDW46		3-212
BDW94C	BDW47		3-212
BDX10	2N3055A		3-5
BDX10-4	2N3055A		3-5
BDX10-6	2N3055A		3-5
BDX10-7	2N3055A		3-5
BDX10C	2N3055A		3-5
BDX18	MJ2955		3-2
BDX33B	BDX33B		3-217
BDX33C	BDX33C		3-217
BDX33D		BDX33C	3-217
BDX34B	BDX34B		3-217
BDX34C	BDX34C		3-217
BDX34D		BDX34C	3-217
BDX35	TIP42C		3-883
BDX36	TIP42D		—
BDX37	TIP42D		—
BDX42	BD775		—
BDX43	BD777		3-192
BDX45	BD776		3-192
BDX46	BD778		3-192
BDX53	BDX53B		3-221
BDX53A	BDX53B		3-221
BDX53B	BDX53B		3-221
BDX53C	BDX53C		3-221
BDX53D		BDX53C	3-221
BDX54	BDX54B		3-221
BDX54A	BDX54B		3-221
BDX54B	BDX54B		3-221
BDX54C	BDX54C		3-221
BDX54D		BDX54C	3-221
BDX70		2N6487	3-132
BDX71		2N6487	3-132
BDX72		2N6488	3-132
BDX73		2N6488	3-132
BDX74		2N6487	3-132
BDX75		2N6487	3-132
BDX83	MJ3001		3-425
BDX83A	MJ3001		3-425

INDEX AND CROSS REFERENCE (continued)

Industry Part Number	Motorola Nearest Replacement	Motorola Similar Replacement	Page Number
BDX83B	MJ3001		3-425
BDX83C	MJ4035		—
BDX84	MJ2501		3-425
BDX84A	MJ2501		3-425
BDX84B	MJ2501		3-425
BDX84C	MJ4032		—
BDX91	2N3716		3-12
BDX92	2N3792		3-25
BDX93	2N3716		3-12
BDX94	2N3792		3-25
BDX95		2N5882	3-77
BDX96	2N5880		3-77
BDY29	2N5303		3-54
BDY34	BD787		3-194
BDY37	2N3773		3-21
BDY96	BUX48		3-401
BDY96-1	BUX48		3-401
BDY96/01	BUX48		3-401
BDY97	BUX48		3-401
BDY97-1	BUX48		3-401
BU1008ADF		MJF16018+DIODE	—
BU1008AF		MJF16018	—
BU104P	BU406		3-244
BU105		BU208A	3-226
BU108		BU208A	3-226
BU109P	BU407		3-244
BU124	BU426		—
BU126		BUX48A	3-401
BU134	MJ423		3-419
BU137		MJ16018	3-520
BU157		MJ16018	3-520
BU180		MJE5741	3-640
BU180A		MJE5742	3-640
BU204		BU208A	3-226
BU205		BU208A	3-226
BU205A		BU208A	3-226
BU207		BU208A	3-226
BU208	BU208A		3-226
BU208A	BU208A		3-226
BU208D		MJF16018+DIODE	—
BU223		MJ423	3-419
BU223A		MJ423	3-419
BU322	BU323A		3-231
BU322A	BU323A		3-231
BU323	BU323A		3-231
BU323A	BU323A		3-231
BU323AP	BU323AP		3-235
BU323P	BU323AP		3-235
BU323Z	BU323Z		3-239
BU326A			—
BU406	BU406		3-244
BU407	BU407		3-244
BU426		BUV48	3-391
BU426A		BUV48A	3-391
BU433		BUV48	3-391
BU500	BU500		—
BU522	BU522B		3-246
BU522A	BU522B		3-246
BU522B	BU522B		3-246
BU806	BU806		3-249
BU808		BU208A	3-226
BUD43B	BUD43B		3-251
BUD44D2	BUD44D2		3-253

Industry Part Number	Motorola Nearest Replacement	Motorola Similar Replacement	Page Number
BUF420A		MJW18020	—
BUH100	BUH100		3-278
BUH150	BUH150		3-287
BUH50	BUH50		3-262
BUH51	BUH51		3-270
BUL146	BUL146		3-335
BUL146F	BUL146F		3-335
BUL147	BUL147		3-343
BUL147F	BUL147F		3-343
BUL382	BUL45		3-316
BUL43B	BUL43B		3-304
BUL44	BUL44		3-296
BUL44D2	BUL44D2		3-306
BUL44F	BUL44F		3-296
BUL45	BUL45		3-316
BUL45D2	BUL45D2		3-325
BUL45F	BUL45F		3-316
BUS11		MJE16002	3-688
BUS12	BUX48		3-401
BUS12A	BUX48A		3-401
BUS13	BUX48		3-401
BUS13A	BUX48A		3-401
BUS14	BUX98		—
BUS14A	BUX98A		—
BUS46P		MJE16002	3-688
BUS47	BUX48		3-401
BUS47A	BUX48A		3-401
BUS47AP	BUV47A		—
BUS47P	BUV47		—
BUS48	BUX48		3-401
BUS48A	BUX48A		3-401
BUS48AP		MJW16010A	3-847
BUS48P		MJW16010A	3-847
BUS50	BUS50		3-351
BUS52	BUS52		—
BUS97	MJ16010		3-512
BUS98	BUX98		3-353
BUS98A	BUX98A		3-353
BUT11AF	BUT11AF		3-360
BUT33	BUT33		3-364
BUT34	BUT34		3-370
BUT35	BUT35		—
BUT56A	BUT56A		—
BUT90	BUS50		3-351
BUT91	BUS52		—
BUT92		BUS52	—
BUV10	BUV10		—
BUV10N		BUV10	—
BUV11	BUV11		3-376
BUV11N		BUV11	3-376
BUV12		BUV11	3-376
BUV18		BUS50	3-351
BUV19		BUS50	3-351
BUV20	BUV20		3-379
BUV21	BUV21		3-382
BUV21N		BUV21	3-382
BUV22	BUV22		3-385
BUV23	BUV23		3-388
BUV24		BUX98	—
BUV25	BUX98A		—
BUV44	BUX48		3-401
BUV45	BUX48A		3-401
BUV46	BUV46		—

INDEX AND CROSS REFERENCE (continued)

Industry Part Number	Motorola Nearest Replacement	Motorola Similar Replacement	Page Number
BUV47		BUV48	3-391
BUV47A		BUV48A	3-391
BUV48	BUV48		3-391
BUV48A	BUV48A		3-391
BUV60	BUV60		—
BUV98A		MJW18020	—
BUW13		MJW16010A	3-847
BUW13A		MJW16010A	3-847
BUW34	BUX48		3-401
BUW35	BUX48		3-401
BUW36	BUX48A		3-401
BUW44	BUX48		3-401
BUW45	BUX48		3-401
BUW46	BUX48A		3-401
BUW72		MJE13009	3-676
BUW74	BUX48		3-401
BUW75	BUX48		3-401
BUW76	BUX48		3-401
BUW77	BUX48		3-401
BUW84	MJE13003		3-655
BUW85	MJE13003		3-655
BUX11	BUX11		—
BUX12		BUV11	3-376
BUX13		BUX48	3-401
BUX14	BUX48		3-401
BUX15	BUX48A		3-401
BUX17	BUX48		3-401
BUX17A	BUX48		3-401
BUX17B	BUX48		3-401
BUX17C	BUX48		3-401
BUX18	2N6544		—
BUX18A	2N6544		—
BUX18B	BUX48A		3-401
BUX18C	BUX48A		3-401
BUX21	BUV21		3-382
BUX41	BUX41		3-398
BUX41N		BUX41	3-398
BUX42		BUX48	3-401
BUX43		BUX48	3-401
BUX47		BUX48	3-401
BUX47A		BUX48A	3-401
BUX48	BUX48		3-401
BUX48A	BUX48A		3-401
BUX48S	BUX48		3-401
BUX82		BUX48A	3-401
BUX83		BUX48A	3-401
BUX84	BUX85		3-408
BUX85	BUX85		3-408
BUX86		MJE13003	3-655
BUX87		MJE13003	3-655
BUX80		2N6547	3-140
BUX98	BUX98		—
BUX98A	BUX98A		—
BUY29	MJ410		3-417
BUY30		MJ423	3-419
BUY49P		MJE340	3-602
BUY69A	BUX48A		3-401
BUY69B	BUX48		3-401
D40C1		MJE800	3-612
D40C2		MJE800	3-612
D40C4		MJE800	3-612
D40C5		MJE800	3-612
D40D1		MJE181	3-589

Industry Part Number	Motorola Nearest Replacement	Motorola Similar Replacement	Page Number
D40D10		MJE182	3-589
D40D11		MJE182	3-589
D40D13		MJE182	3-589
D40D14		MJE182	3-589
D40D2		MJE181	3-589
D40D3		MJE181	3-589
D40D4		MJE181	3-589
D40D5		MJE181	3-589
D40D7		MJE181	3-589
D40D8		MJE181	3-589
D40E1		MJE181	3-589
D40E5		MJE181	3-589
D40E7		MJE182	3-589
D40K1		MJE800	3-612
D40K2		MJE800	3-612
D40K3		MJE800	3-612
D40K4		MJE800	3-612
D40N1		MJE340	3-602
D40N2		MJE340	3-602
D40N3		MJE340	3-602
D40N4		MJE340	3-602
D40P1		MJE341	3-604
D40P3		MJE344	3-604
D40P5		MJE340	3-602
D41C2		D44H8	3-411
D41D1		2N4918	3-34
D41D10		2N4920	3-34
D41D11		2N4920	3-34
D41D13		2N4920	3-34
D41D14		2N4920	3-34
D41D2		2N4918	3-34
D41D4		2N4919	3-34
D41D5		2N4919	3-34
D41D7		2N4919	3-34
D41D8		2N4919	3-34
D41E1		2N4918	3-34
D41E5		2N4919	3-34
D41E7		2N4920	3-34
D41K1		MJE700	3-612
D41K2		MJE700	3-612
D41K3		MJE700	3-612
D41K4		MJE700	3-612
D42C1		MJE181	3-589
D42C2		MJE181	3-589
D42C3		MJE181	3-589
D42C4		MJE171	3-589
D42C5		MJE171	3-589
D42C6		MJE171	3-589
D42C7		MJE171	3-589
D42C8		MJE171	3-589
D42C9		MJE171	3-589
D43C1		MJE181	3-589
D43C2		MJE181	3-589
D43C3		MJE181	3-589
D43C4		MJE171	3-589
D43C5		MJE171	3-589
D43C6		MJE171	3-589
D43C7		MJE171	3-589
D43C8		MJE171	3-589
D43C9		MJE171	3-589
D44D1		TIP101	3-891
D44D2		TIP101	3-891
D44D3		2N6044	3-89

INDEX AND CROSS REFERENCE (continued)

Industry Part Number	Motorola Nearest Replacement	Motorola Similar Replacement	Page Number
D44D4		2N6044	3-89
D44D5		2N6044	3-89
D44D6		2N6044	3-89
D44H1	D44H8		3-411
D44H10	D44H10		3-411
D44H11	D44H11		3-411
D44H2	D44H8		3-411
D44H4	D44H8		3-411
D44H5	D44H8		3-411
D44H7	D44H8		3-411
D44H8	D44H8		3-411
D44R1		TIP47	3-887
D44R2		TIP47	3-887
D44R3		TIP48	3-887
D44R4		TIP48	3-887
D44R5		TIP47	3-887
D44R6		TIP48	3-887
D44TD3		MJE16002	3-688
D44TD4		MJE16002	3-688
D44TD5		MJE16002	3-688
D44TE3		MJE16002	3-688
D44TE4		MJE16002	3-688
D44TE5		MJE16002	3-688
D44VH1	D44VH10		3-413
D44VH10	D44VH10		3-413
D44VH4	D44VH10		3-413
D44VH7	D44VH10		3-413
D45C1	D45C12		3-415
D45C10	D45C12		3-415
D45C11	D45C12		3-415
D45C12	D45C12		3-415
D45C2	D45C12		3-415
D45C3	D45C12		3-415
D45C4	D45C12		3-415
D45C5	D45C12		3-415
D45C6	D45C12		3-415
D45C7	D45C12		3-415
D45C8	D45C12		3-415
D45C9	D45C12		3-415
D45E1		TIP125	3-900
D45E2		TIP126	3-900
D45E3		TIP126	3-900
D45H1	D45H11		3-411
D45H10	D45H10		3-411
D45H11	D45H11		3-411
D45H12		D45H11	3-411
D45H2	D45H8		3-411
D45H4	D45H8		3-411
D45H5	D45H8		3-411
D45H7	D45H8		3-411
D45H8	D45H8		3-411
D45H9	D45H11		3-411
D45VH1	D45VH10		3-413
D45VH10	D45VH10		3-413
D45VH4	D45VH10		3-413
D45VH7	D45VH10		3-413
D56W1		BU208A	3-226
D56W2		BU208A	3-226
D56W3		BU208A	3-226
D56W4		BU208A	3-226
D64VP4		MJ16010	3-512
D64VP5		MJ16010	3-512
D72F5T1		MJD44H11-1	3-550

Industry Part Number	Motorola Nearest Replacement	Motorola Similar Replacement	Page Number
D72F5T2		MJD44H11	3-550
D72FYD		MJD6039	3-584
D72FYD1		MJD6039-1	3-584
D72K1.5D1		MJD6039-1	3-584
D72K1.5D2		MJD6039	3-584
D72K3D1		MJD6039-1	3-584
D72K3D2		MJD6039	3-584
D73F5T1		MJD44H11-1	3-550
D73F5T2		MJD44H11	3-550
D73FY4D		MJD6039	3-584
D73FY4D1		MJD6039-1	3-584
D73K3D1		MJD6039-1	3-584
D73K3D2		MJD6039	3-584
DTS1010		2N6056	3-97
DTS1020		MJ3001	3-425
DTS401		BUX48A	3-401
DTS402		BUX48A	3-401
DTS4026		MJ10012	3-457
DTS4039		MJ10000	3-433
DTS4040		MJ10000	3-433
DTS4041		MJ10000	3-433
DTS4045		MJ10000	3-433
DTS4059		MJ10000	3-433
DTS4061		MJ10000	3-433
DTS4066		MJ10000	3-433
DTS4067		MJ10000	3-433
DTS4074		MJ10005	3-439
DTS4075		MJ10005	3-439
DTS410		MJ410	3-417
DTS411		MJ423	3-419
DTS413		MJ413	3-419
DTS423		MJ423	3-419
DTS425		BUX48A	3-401
DTS431		MJ423	3-419
DTS660		2N6233	—
DTS663		2N6235	—
DTS665		2N6235	—
DTS701		BU208A	3-226
DTS702		BU208A	3-226
DTS712		BU208A	3-226
DTS714		BU208A	3-226
DTS801		BU208A	3-226
DTS802		BU208A	3-226
DTS804		BU208A	3-226
DTS812		BU208A	3-226
DTS814		BU208A	3-226
FT2955		MJE2955T	3-628
FT3055		MJE3055T	3-628
FT317		MJE15028	3-684
FT317A	MJE15028		3-684
FT317B	MJE15030		3-684
FT401B		BUX48A	3-401
FT402		BUX48A	3-401
FT410		MJ410	3-417
FT411		MJ423	3-419
FT413		MJ413	3-419
FT417	MJE15029		3-684
FT417A	MJE15029		3-684
FT417B	MJE15031		3-684
FT423		MJ423	3-419
FT431		MJ423	3-419
FT47		TIP47	3-887
FT48		TIP48	3-887

INDEX AND CROSS REFERENCE (continued)

Industry Part Number	Motorola Nearest Replacement	Motorola Similar Replacement	Page Number
FT49		TIP49	3-887
FT50		TIP50	3-887
GE5060		MJ10000	3-433
GE5061		MJ10000	3-433
GE6060		MJ10015	3-461
GE6061		MJ10015	3-461
GE6062		MJ10015	3-461
GE6251		MJ10005	3-439
GE6252		MJ10005	3-439
GE6253		MJ10005	3-439
IR1000		MJ1000	3-423
IR1001		MJ1001	3-423
IR1010		2N6056	3-97
IR1020		MJ3001	3-425
IR2500		MJ2501	3-425
IR2501		MJ2501	3-425
IR3000		MJ3001	3-425
IR3001		MJ3001	3-425
IR3771		2N3771	3-17
IR3772		2N3772	3-17
IR3777		2N3773	3-21
IR401		BUX48A	3-401
IR402		BUX48A	3-401
IR4039		MJ10000	3-433
IR4040		MJ10000	3-433
IR4041		MJ10000	3-433
IR4045		MJ10000	3-433
IR4050		MJ10000	3-433
IR4055		MJ10000	3-433
IR4059		MJ10000	3-433
IR4061		MJ10000	3-433
IR410		MJ410	3-417
IR411		MJ423	3-419
IR413		MJ413	3-419
IR423		MJ423	3-419
IR425		BUX48A	3-401
IR431		MJ423	3-419
IR4502		MJ4502	3-431
IR5000		MJ10000	3-433
IR5001		MJ10000	3-433
IR5060		MJ10000	3-433
IR5061		MJ10000	3-433
IR515		BUV23	3-388
IR516		BUV23	3-388
IR517		2N6251	3-104
IR518		2N6547	3-140
IR519		2N6547	3-140
IR5252		MJ10007	3-445
IR5261		MJ10007	3-445
IR6000		MJ10005	3-439
IR6001		MJ10005	3-439
IR6002		MJ10005	3-439
IR6060		MJ10005	3-439
IR6061		MJ10005	3-439
IR6062		MJ10005	3-439
IR6251		MJ10007	3-445
IR6252		MJ10007	3-445
IR6302		2N5631	3-59
IR640		MJ3001	3-425
IR641		MJ3001	3-425
IR642		2N6578	3-144
IR645		MJ2501	3-425
IR646		MJ2501	3-425

Industry Part Number	Motorola Nearest Replacement	Motorola Similar Replacement	Page Number
IR647		2N6052	3-93
IR660		MJ410	3-417
IR663		MJ423	3-419
IR665		BU208A	3-226
IR701		BU208A	3-226
IR801		BU208A	3-226
IR802		MJ802	3-421
KDT410		MJ410	3-417
KDT411		MJ423	3-419
KDT413		MJ413	3-419
KDT423		MJ423	3-419
KDT431		MJ423	3-419
KP3946		KP3946	3-108
KP3948		2N6274	3-108
KSA1010		MJE15029	3-684
KSA1220A		MJE350	3-606
KSA614		TIP42B	3-883
KSA940		MJE15031	3-684
KSB546		MJE15031	3-684
KSB596		TIP32B	3-873
KSB601		BDX34C	3-217
KSB707		D45H11	3-411
KSB744		MJE171	3-589
KSB744A		MJE171	3-589
KSB772		MJE171	3-589
KSB794		MJE703	3-612
KSB795		MJE703	3-612
KSB834		TIP32B	3-873
KSC1507		MJE2360T	3-626
KSC1520		MJE3439	3-630
KSC1520A		MJE2360T	3-626
KSC2073		MJE15030	3-684
KSC2233		TIP41C	3-883
KSC2334		MJE15028	3-684
KSC2335		MJE13007	3-667
KSC2517		TIP41C	3-883
KSC2688		MJE3439	3-630
KSC2690		MJE340	3-602
KSC2690A		MJE340	3-602
KSC2752		2N5657	3-63
KSD288		TIP41B	3-883
KSD362		D44H11	3-411
KSD363		MJE15028	3-684
KSD401		MJE15030	3-684
KSD526		TIP31B	3-873
KSD560		BDX33C	3-217
KSD568		D44H11	3-411
KSD569		D44H11	3-411
KSD708		D45H11	3-411
KSD73		D44H8	3-411
KSD794		MJE181	3-589
KSD794A		MJE181	3-589
KSD818		MJW16018	3-520
KSD819		MJW16018	3-520
KSD820		MJW16018	3-520
KSD821		MJW16018	3-520
KSD868		MJW16018	3-520
KSD869		MJW16018	3-520
KSD870		MJW16018	3-520
KSD871		MJW16018	3-520
KSD880		TIP31B	3-873
KSD882		MJE181	3-589
KSD985		MJE803	3-612

INDEX AND CROSS REFERENCE (continued)

Industry Part Number	Motorola Nearest Replacement	Motorola Similar Replacement	Page Number
KSD986		MJE803	3-612
MDS1678		MJE181	3-589
MDS20		2N5657	3-63
MDS21		2N5657	3-63
MDS26		MJE181	3-589
MDS27		MJE181	3-589
MDS60		MJE350	3-606
MDS73		MJE171	3-589
MDS74		MJE172	3-589
MDS75		MJE253	3-596
MDS76		MJE181	3-589
MDS77		MJE171	3-589
MJ1000	MJ1001		3-423
MJ10000	MJ10000		3-433
MJ10002	MJ10007		3-445
MJ10003		MJ10007	3-445
MJ10004	MJ10005		3-439
MJ10005	MJ10005		3-439
MJ10006	MJ10007		3-445
MJ10007	MJ10007		3-445
MJ10009	MJ10009		3-451
MJ1001	MJ1001		3-423
MJ10012	MJ10012		3-457
MJ10015	MJ10015		3-461
MJ10016	MJ10016		3-461
MJ10020	MJ10020		3-466
MJ10021	MJ10021		3-466
MJ10022	MJ10022		3-472
MJ10023	MJ10023		3-472
MJ105		BU208A	3-226
MJ11011	MJ11013		3-478
MJ11012	MJ11014		3-478
MJ11013	MJ11013		3-478
MJ11014	MJ11014		3-478
MJ11015	MJ11015		3-478
MJ11016	MJ11016		3-478
MJ11017	MJ11017		3-481
MJ11018	MJ11018		3-481
MJ11021	MJ11021		3-481
MJ11022	MJ11022		3-481
MJ11028	MJ11030		3-485
MJ11029	MJ11031		3-485
MJ11030	MJ11030		3-485
MJ11031	MJ11031		3-485
MJ11032	MJ11032		3-485
MJ11033	MJ11033		3-485
MJ12002		BU208A	3-226
MJ12003		BU208A	3-226
MJ12004		BU208A	3-226
MJ12005		MJ16018	3-520
MJ12022		MJ16012	3-512
MJ13010		2N6547	3-140
MJ13018		BUV23	3-388
MJ13019		BUV23	3-388
MJ1302A	MJ1302A		3-427
MJ13080		MJE16106	3-696
MJ13090		MJ16110	3-529
MJ13091		MJ16010	3-512
MJ13330		BUV23	3-388
MJ13331		BUV23	3-388
MJ13332		MJ13333	3-487
MJ13333	MJ13333		3-487
MJ14000	MJ14002		3-493

Industry Part Number	Motorola Nearest Replacement	Motorola Similar Replacement	Page Number
MJ14001	MJ14003		3-493
MJ14002	MJ14002		3-493
MJ14003	MJ14003		3-493
MJ15001	MJ15001		3-497
MJ15002	MJ15002		3-497
MJ15003	MJ15003		3-500
MJ15004	MJ15004		3-500
MJ15011	MJ15011		3-502
MJ15012	MJ15012		3-502
MJ15015	MJ15015		3-5
MJ15016	MJ15016		3-5
MJ15018	MJ15020		3-504
MJ15019	MJ15021		3-504
MJ15020	MJ15020		3-504
MJ15021	MJ15021		3-504
MJ15022	MJ15024		3-506
MJ15023	MJ15025		3-509
MJ15024	MJ15024		3-506
MJ15025	MJ15025		3-509
MJ15026		MJ15024	3-506
MJ15027		MJ15025	3-509
MJ16008	MJ16010		3-512
MJ16010	MJ16010		3-512
MJ16012	MJ16012		3-512
MJ16014	MJ16018		3-520
MJ16016	MJ16018		3-520
MJ16018	MJ16018		3-520
MJ16020	MJ16020		3-526
MJ16022	MJ16022		3-526
MJ16110	MJ16110		3-529
MJ205		BU208A	3-226
MJ21193	MJ21193		3-537
MJ21194	MJ21194		3-537
MJ2267		MJ15016	3-5
MJ2268		MJ2955	3-2
MJ2300		MJE270	3-600
MJ2305		MJE271	3-600
MJ2500	MJ2501		3-425
MJ2501	MJ2501		3-425
MJ2801		2N3055	3-2
MJ2802		2N5882	3-77
MJ2840		2N5878	3-74
MJ2841		2N5878	3-74
MJ2901		MJ15016	3-5
MJ2955	MJ2955		3-2
MJ2955A	MJ2955A		3-5
MJ3000	MJ3001		3-425
MJ3001	MJ3001		3-425
MJ3029		BUX48A	3-401
MJ3030	BUX48A		3-401
MJ3042		MJ10012	3-457
MJ3055	2N3055		3-2
MJ3055A	2N3055A		3-5
MJ3237		MJE15031	3-684
MJ3238		MJE15031	3-684
MJ3247		MJE15030	3-684
MJ3248		MJE15030	3-684
MJ3281A	MJ3281A		3-427
MJ4030	MJ11013		3-478
MJ4031	MJ11013		3-478
MJ4032	MJ11015		3-478
MJ4033	MJ11014		3-478
MJ4034	MJ11014		3-478

INDEX AND CROSS REFERENCE (continued)

Industry Part Number	Motorola Nearest Replacement	Motorola Similar Replacement	Page Number
MJ4035	MJ11016		3-478
MJ410	MJ410		3-417
MJ411		MJ423	3-419
MJ413	MJ413		3-419
MJ423	MJ423		3-419
MJ4237		MJ15012	3-502
MJ4238		MJ15012	3-502
MJ4247		MJ15011	3-502
MJ4248		MJ15011	3-502
MJ425		BUX48A	3-401
MJ431		MJ423	3-419
MJ4360		MJE13002	3-655
MJ4361		MJE13003	3-655
MJ4380		MJE13005	3-661
MJ4381		MJE13005	3-661
MJ4400		MJE13005	3-661
MJ4401		MJE13005	3-661
MJ4502	MJ4502		3-431
MJ480		2N3055	3-2
MJ481		2N3055	3-2
MJ490		2N3792	3-25
MJ491		2N3792	3-25
MJ701		BU208A	3-226
MJ702		BU208A	3-226
MJ704		BU208A	3-226
MJ721		BU208A	3-226
MJ723		BU208A	3-226
MJ802	MJ802		3-421
MJ804		BU208A	3-226
MJ8500		BU208A	3-226
MJ8501		BU208A	3-226
MJ8502		BU208A	3-226
MJ8503		BU208A	3-226
MJ8504		MJ16018	3-520
MJ8505		MJ16018	3-520
MJD112	MJD112		3-558
MJD112-1	MJD112-1		3-558
MJD117	MJD117		3-558
MJD117-1	MJD117-1		3-558
MJD117RL	MJD117T4		3-558
MJD122	MJD122		3-563
MJD122-1	MJD122-1		3-563
MJD127	MJD127		3-563
MJD127-1	MJD127-1		3-563
MJD127RL	MJD127T4		3-563
MJD200	MJD200		3-569
MJD200-1	MJD200-1		3-569
MJD210	MJD210		3-569
MJD210-1	MJD210-1		3-569
MJD210RL	MJD210T4		3-569
MJD243	MJD243		3-573
MJD243-1	MJD243-1		3-573
MJD253	MJD253		—
MJD253-1	MJD253-1		—
MJD29	MJD31		3-542
MJD29-1	MJD31-1		3-542
MJD2955	MJD2955		3-580
MJD2955-1	MJD2955-1		3-580
MJD2955RL	MJD2955T4		3-580
MJD29C	MJD31C		3-542
MJD29C1	MJD31C1		3-542
MJD30	MJD32		3-542
MJD30-1	MJD32-1		3-542

Industry Part Number	Motorola Nearest Replacement	Motorola Similar Replacement	Page Number
MJD3055	MJD3055		3-580
MJD3055-1	MJD3055-1		3-580
MJD30C	MJD32C		3-542
MJD30C1	MJD32C1		3-542
MJD31	MJD31		3-542
MJD31-1	MJD31-1		3-542
MJD31C	MJD31C		3-542
MJD31C1	MJD31C1		3-542
MJD32	MJD32		3-542
MJD32-1	MJD32-1		3-542
MJD32C	MJD32C		3-542
MJD32C1	MJD32C1		3-542
MJD32CRL	MJD32CT4		3-542
MJD32RL	MJD32RL		—
MJD340	MJD340		3-577
MJD340-1	MJD340-1		3-577
MJD350	MJD350		3-577
MJD350-1	MJD350-1		3-577
MJD350RL	MJD350T4		3-577
MJD41C	MJD41C		3-546
MJD41C1	MJD41C1		3-546
MJD42C	MJD42C		3-546
MJD42C-1	MJD42C-1		3-546
MJD42CRL	MJD42CT4		3-546
MJD44H11	MJD44H11		3-550
MJD44H11-1	MJD44H11-1		3-550
MJD45H11	MJD45H11		3-550
MJD45H11-1	MJD45H11-1		3-550
MJD45H11RL	MJD45H11T4		3-550
MJD47	MJD47		3-554
MJD47-1	MJD47-1		3-554
MJD50	MJD50		3-554
MJD50-1	MJD50-1		3-554
MJD6036	MJD6036		3-584
MJD6036-1	MJD6036-1		3-584
MJD6036RL	MJD6036T4		3-584
MJD6039	MJD6039		3-584
MJD6039-1	MJD6039-1		3-584
MJE101		MJE2955T	3-628
MJE102		MJE2955T	3-628
MJE103		MJE2955T	3-628
MJE104		MJE2955T	3-628
MJE105		TIP42B	3-883
MJE1090		TIP106	3-891
MJE1091		TIP107	3-891
MJE1092		TIP106	3-891
MJE1093		TIP107	3-891
MJE1100		TIP101	3-891
MJE1101		TIP101	3-891
MJE1102		TIP102	3-891
MJE1103		TIP102	3-891
MJE1123	MJE1123		3-616
MJE12007		MJE1320	3-620
MJE1290		2N6491	3-132
MJE1291		2N6491	3-132
MJE13002	MJE13002		3-655
MJE13003	MJE13003		3-655
MJE13004	MJE13005		3-661
MJE13005	MJE13005		3-661
MJE13006	MJE13007		3-667
MJE13007	MJE13007		3-667
MJE13008	MJE13009		3-676
MJE13009	MJE13009		3-676

INDEX AND CROSS REFERENCE (continued)

Industry Part Number	Motorola Nearest Replacement	Motorola Similar Replacement	Page Number	
MJE13070	MJE1320	MJE16002	3-688	
MJE13071		MJE16002	3-688	
MJE1320			3-620	
MJE15020		MJE15028 MJE15029 MJE15030	MJE13007	3-667
MJE15028				3-684
MJE15029				3-684
MJE15030				3-684
MJE15031	MJE15031		3-684	
MJE15032	MJE15032		—	
MJE15033	MJE15033		—	
MJE16002	MJE16002		3-688	
MJE16004	MJE16004		3-688	
MJE16032		MJW16018	3-520	
MJE16034		MJW16018	3-520	
MJE16080	MJE16106 MJE16204	MJW16206	3-855	
MJE16081		MJW16206	3-855	
MJE16106			3-696	
MJE16204			3-814	
MJE1660		2N6487		3-132
MJE1661				3-132
MJE170		MJE171		3-589
MJE171	MJE171		3-589	
MJE172	MJE172		3-589	
MJE180	MJE181		3-589	
MJE18002	MJE18002		3-704	
MJE18002D2	MJE18002D2		3-712	
MJE18004	MJE18004		3-715	
MJE18004D2	MJE18004D2		3-724	
MJE18006	MJE18006		3-734	
MJE18008	MJE18008		3-742	
MJE18009	MJE18009		3-750	
MJE181	MJE181		3-589	
MJE182	MJE182		3-589	
MJE18204	MJE18204		3-759	
MJE18206	MJE18206		3-769	
MJE18604D2	MJE18604D2		3-779	
MJE200	MJE200		3-592	
MJE201	MJE3055T TIP42B TIP42B MJE3055T TIP41B	MJE3055T	3-628	
MJE2010		TIP42B	3-883	
MJE2011		TIP42B	3-883	
MJE202		MJE3055T	3-628	
MJE2020		TIP41B	3-883	
MJE2021		TIP41B	3-883	
MJE203		MJE3055T	3-628	
MJE204	MJE3055T	3-628		
MJE205	MJE3055T	3-628		
MJE2050	MJE200	3-592		
MJE2055	MJE3055T	3-628		
MJE205K	TIP41B	3-883		
MJE2090	MJE210	TIP125	3-900	
MJE2091		TIP125	3-900	
MJE2092		TIP126	3-900	
MJE2093		TIP126	3-900	
MJE210			3-592	
MJE2100		TIP120	3-900	
MJE2101		TIP120	3-900	
MJE2102		TIP121	3-900	
MJE2103		TIP121	3-900	
MJE2150		MJE210	3-592	
MJE2160		TIP48	3-887	
MJE220	MJE181	3-589		
MJE221	MJE181	3-589		
MJE222	MJE181	3-589		

Industry Part Number	Motorola Nearest Replacement	Motorola Similar Replacement	Page Number
MJE223		MJE182	3-589
MJE224		MJE182	3-589
MJE225		MJE182	3-589
MJE230		MJE171	3-589
MJE231		MJE171	3-589
MJE232		MJE171	3-589
MJE233		MJE172	3-589
MJE234		MJE172	3-589
MJE235		MJE172	3-589
MJE2360	MJE2360T	MJE2360T	3-626
MJE2360T			3-626
MJE2361		MJE2361T	3-626
MJE2361T	MJE2361T		3-626
MJE2370		TIP32B	3-873
MJE2371	MJE243 MJE243 MJE243	TIP32B	3-873
MJE242			3-596
MJE243			3-596
MJE244			3-596
MJE2480		TIP31B	3-873
MJE2481		TIP31B	3-873
MJE2482		TIP31B	3-873
MJE2483	MJE253	TIP31B	3-873
MJE2490		TIP32B	3-873
MJE2491		TIP32B	3-873
MJE252			3-596
MJE2520		TIP31B	3-873
MJE2521		TIP31B	3-873
MJE2522		TIP31B	3-873
MJE2523	MJE253 MJE253 MJE253 MJE271	TIP31B	3-873
MJE253			3-596
MJE254			3-596
MJE270			3-596
MJE271			3-600
MJE2801	MJE3055T	2N6107	3-101
MJE2801K		MJE3055T	3-628
MJE2801T	MJE3055T		3-628
MJE29	MJE2955T	TIP31B	3-873
MJE2901		MJE2955T	3-628
MJE2901K		MJE2955T	3-628
MJE2901T		MJE2955T	3-628
MJE2955		MJE2955T	3-628
MJE2955K		MJE2955T	3-628
MJE2955T			3-628
MJE29A		TIP31B	3-873
MJE29B		TIP31B	3-873
MJE29C		TIP31C	3-873
MJE30	TIP32B	3-873	
MJE3055	2N6107	3-101	
MJE3055K	MJE3055T	3-628	
MJE3055T	MJE3055T		3-628
MJE30A		TIP32B	3-873
MJE30B		TIP32B	3-873
MJE30C		TIP32C	3-873
MJE31		TIP31B	3-873
MJE31A		TIP31B	3-873
MJE31B		TIP31B	3-873
MJE31C		TIP31C	3-873
MJE32	TIP32B	3-873	
MJE32A	TIP32B	3-873	
MJE32B	TIP32B	3-873	
MJE32C	TIP32C	3-873	
MJE33	TIP41B	3-883	
MJE3300	2N6038	3-85	

INDEX AND CROSS REFERENCE (continued)

Industry Part Number	Motorola Nearest Replacement	Motorola Similar Replacement	Page Number
MJE3301		2N6038	3-85
MJE3302		2N6039	3-85
MJE3310		2N6035	3-85
MJE3311		2N6035	3-85
MJE3312		2N6036	3-85
MJE3370		MJE371	3-608
MJE3371		2N5194	3-49
MJE33A		TIP41B	3-883
MJE33B		TIP41B	3-883
MJE33C		TIP41C	3-883
MJE34		TIP42B	3-883
MJE340	MJE340		3-602
MJE340K		TIP48	3-887
MJE341	MJE341		3-604
MJE341K		TIP47	3-887
MJE3439	MJE3439		3-630
MJE344	MJE344		3-604
MJE3440	MJE3439		3-630
MJE344K		TIP47	3-887
MJE345		MJE3439	3-630
MJE34A		TIP42B	3-883
MJE34B		TIP42B	3-883
MJE34C		TIP42C	3-883
MJE350	MJE350		3-606
MJE3520		MJE521	3-610
MJE3521		2N5191	3-44
MJE370	MJE371		3-608
MJE370K		TIP32B	3-873
MJE371	MJE371		3-608
MJE371K		TIP32B	3-873
MJE3738		TIP47	3-887
MJE3739		TIP48	3-887
MJE41		TIP41B	3-883
MJE41A		TIP41B	3-883
MJE41B		TIP41B	3-883
MJE41C		TIP41C	3-883
MJE42		TIP42B	3-883
MJE42A		TIP42B	3-883
MJE42B		TIP42B	3-883
MJE42C		TIP42C	3-883
MJE4340	MJE4342		3-632
MJE4341	MJE4342		3-632
MJE4342	MJE4342		3-632
MJE4343	MJE4343		3-632
MJE4350	MJE4352		3-632
MJE4351	MJE4352		3-632
MJE4352	MJE4352		3-632
MJE4353	MJE4353		3-632
MJE47		TIP47	3-887
MJE48		TIP48	3-887
MJE482		2N5191	3-44
MJE483		2N5191	3-44
MJE484		2N5192	3-44
MJE488		2N5191	3-44
MJE49		TIP49	3-887
MJE4918		TIP32B	3-873
MJE4919		TIP32B	3-873
MJE492		2N5194	3-49
MJE4920		TIP32B	3-873
MJE4921		TIP31B	3-873
MJE4922		TIP31B	3-873
MJE4923		TIP31B	3-873
MJE493		2N5194	3-49

Industry Part Number	Motorola Nearest Replacement	Motorola Similar Replacement	Page Number
MJE494		2N5195	3-49
MJE51		2N6497	3-136
MJE5170		MJE15031	3-684
MJE5171		MJE15031	3-684
MJE5172		MJE15031	3-684
MJE5180		MJE15030	3-684
MJE5181		MJE15030	3-684
MJE5182		MJE15030	3-684
MJE5190		TIP31B	3-873
MJE5191		TIP31B	3-873
MJE5192		TIP31B	3-873
MJE5193		TIP32B	3-873
MJE5194		TIP32B	3-873
MJE5195		TIP32C	3-873
MJE51T		2N6497	3-136
MJE52		2N6498	3-136
MJE520	MJE521		3-610
MJE520K		TIP31B	3-873
MJE521	MJE521		3-610
MJE521K		TIP31B	3-873
MJE5220		D44H10	3-411
MJE5221		D44H10	3-411
MJE5230		D45H10	3-411
MJE5231		D45H10	3-411
MJE52T		2N6498	3-136
MJE53		MJE13005	3-661
MJE53T		MJE13005	3-661
MJE5655		TIP47	3-887
MJE5656		TIP48	3-887
MJE5657		TIP49	3-887
MJE5730	MJE5730		3-636
MJE5731	MJE5731		3-636
MJE5731A	MJE5731A		3-636
MJE5732		MJE5731A	3-636
MJE5740	MJE5742		3-640
MJE5741	MJE5742		3-640
MJE5742	MJE5742		3-640
MJE5850	MJE5851		3-644
MJE5851	MJE5851		3-644
MJE5852	MJE5852		3-644
MJE5960		2N6490	3-132
MJE5974		TIP42B	3-883
MJE5975		TIP42B	3-883
MJE5976		TIP42B	3-883
MJE5977		TIP41B	3-883
MJE5978		TIP41B	3-883
MJE5979		TIP41B	3-883
MJE5980		2N6490	3-132
MJE5981		2N6490	3-132
MJE5982		2N6491	3-132
MJE5983		2N6487	3-132
MJE5984		2N6487	3-132
MJE5985		2N6488	3-132
MJE6040		2N6041	3-89
MJE6041		2N6041	3-89
MJE6042		2N6041	3-89
MJE6043		2N6044	3-89
MJE6044		2N6044	3-89
MJE6045		2N6045	3-89
MJE700	MJE700		3-612
MJE700T	MJE700T		3-612
MJE701	MJE703		3-612
MJE701T	MJE703		3-612

INDEX AND CROSS REFERENCE (continued)

Industry Part Number	Motorola Nearest Replacement	Motorola Similar Replacement	Page Number
MJE702	MJE702		3-612
MJE702T		TIP126	3-900
MJE703	MJE703		3-612
MJE703T		TIP126	3-900
MJE710		2N4918	3-34
MJE711		2N4919	3-34
MJE712		2N4920	3-34
MJE720		2N4921	3-38
MJE721		2N4923	3-38
MJE722		2N4923	3-38
MJE800	MJE800		3-612
MJE800T	MJE800T		3-612
MJE801	MJE803		3-612
MJE801T	MJE803		3-612
MJE802	MJE802		3-612
MJE802T		TIP121	3-900
MJE803	MJE803		3-612
MJE803T		TIP121	3-900
MJE8500		MJE1320	3-620
MJE8501		MJE1320	3-620
MJE8503A	MJE8503A		3-650
MJE9780	MJE9780		3-653
MJF102	MJF6388		3-802
MJF107	MJF6668		3-802
MJF122	MJF122		3-788
MJF127	MJF127		3-788
MJF13007	MJF13007		3-667
MJF13009	MJF13009		—
MJF15030	MJF15030		3-809
MJF15031	MJF15031		3-809
MJF18002	MJF18002		3-704
MJF18004	MJF18004		3-715
MJF18006	MJF18006		3-734
MJF18008	MJF18008		3-742
MJF18009	MJF18009		3-750
MJF18204	MJF18204		3-759
MJF18206	MJF18206		3-769
MJF2955	MJF2955		3-794
MJF3055	MJF3055		3-794
MJF31C	MJF31C		—
MJF32C	MJF32C		—
MJF44H11	MJF44H11		—
MJF45H11	MJF45H11		—
MJF47	MJF47		3-783
MJF6107	MJF6107		3-797
MJF6284		MJH6284	3-821
MJF6287		MJH6287	3-821
MJF6668	MJF6668		3-802
MJH10012	MJH10012		3-457
MJH11017	MJH11017		3-825
MJH11018	MJH11018		3-825
MJH11019	MJH11019		3-825
MJH11020	MJH11020		3-825
MJH11021	MJH11021		3-825
MJH11022	MJH11022		3-825
MJH16006A	MJH16006A		3-830
MJH16010		MJW16010	3-512
MJH16010A		MJW16010A	3-847
MJH16012		MJW16010	3-512
MJH16018		MJW16018	3-520
MJH16032		MJW16018	3-520
MJH16034		MJW16018	3-520
MJH16106		MJE16106	3-696

Industry Part Number	Motorola Nearest Replacement	Motorola Similar Replacement	Page Number
MJH16110		MJW16110	3-529
MJH16206		MJW16206	3-855
MJH16212		MJW16212	3-864
MJH6282	MJH6283		3-821
MJH6283	MJH6283		3-821
MJH6285	MJH6286		3-821
MJH6286	MJH6286		3-821
MJL1302A	MJL1302A		3-851
MJL21193	MJL21193		3-838
MJL21194	MJL21194		3-838
MJL3281A	MJL3281A		3-843
MJW16012	MJW16012		3-512
MJW16018	MJW16018		3-520
MJW16206	MJW16206		3-855
MPC900		2N6052	3-93
NSD102		2N4923	3-38
NSD103		2N4923	3-38
NSD104		2N4923	3-38
NSD105		2N4923	3-38
NSD106		2N4923	3-38
NSD131		MJE340	3-602
NSD132		MJE340	3-602
NSD133		MJE340	3-602
NSD134		MJE340	3-602
NSD135		MJE340	3-602
NSD151		MJE800	3-612
NSD152		MJE800	3-612
NSD202		2N4919	3-34
NSD203		2N4919	3-34
NSD204		2N4919	3-34
NSD205		2N4919	3-34
NSD206		2N4919	3-34
NSD3439		MJE3439	3-630
NSD3440		MJE3439	3-630
NSE170		MJE171	3-589
NSE171		MJE171	3-589
NSE180		MJE181	3-589
NSE181		MJE181	3-589
NSP105		TIP42B	3-883
NSP2010		TIP42B	3-883
NSP2011		TIP42B	3-883
NSP2021		TIP41B	3-883
NSP205		TIP41B	3-883
NSP2090		TIP125	3-900
NSP2091		TIP125	3-900
NSP2092		TIP126	3-900
NSP2093		TIP126	3-900
NSP2100		TIP120	3-900
NSP2101		TIP120	3-900
NSP2102		TIP121	3-900
NSP2103		TIP121	3-900
NSP2370		TIP32B	3-873
NSP2480		TIP31B	3-873
NSP2481		TIP31B	3-873
NSP2490		TIP32B	3-873
NSP2491		TIP32B	3-873
NSP2520		TIP31B	3-873
NSP2955		MJE2955T	3-628
NSP3054		TIP31B	3-873
NSP3055		MJE3055T	3-628
NSP370		TIP32B	3-873
NSP371		TIP32B	3-873
NSP41		TIP41B	3-883

INDEX AND CROSS REFERENCE (continued)

Industry Part Number	Motorola Nearest Replacement	Motorola Similar Replacement	Page Number
NSP41A		TIP41B	3-883
NSP41B		TIP41B	3-883
NSP41C		TIP41C	3-883
NSP42		TIP42B	3-883
NSP42A		TIP42B	3-883
NSP42B		TIP42B	3-883
NSP42C		TIP42C	3-883
NSP4918		TIP32B	3-873
NSP4919		TIP32B	3-873
NSP4920		TIP32B	3-873
NSP4921		TIP31B	3-873
NSP4922		TIP31B	3-873
NSP4923		TIP31B	3-873
NSP5190		TIP31B	3-873
NSP5191		TIP31B	3-873
NSP5192		TIP31B	3-873
NSP5193		TIP32B	3-873
NSP5194		TIP32B	3-873
NSP5195		TIP32C	3-873
NSP520		TIP31B	3-873
NSP521		TIP31B	3-873
NSP575		TIP31B	3-873
NSP576		TIP32B	3-873
NSP577		TIP31B	3-873
NSP578		TIP32B	3-873
NSP579		TIP31B	3-873
NSP580		TIP32B	3-873
NSP581		TIP31C	3-873
NSP582		TIP32C	3-873
NSP585		TIP31B	3-873
NSP586		TIP32B	3-873
NSP587		TIP31B	3-873
NSP588		TIP32B	3-873
NSP589		TIP31B	3-873
NSP590		TIP32B	3-873
NSP595		TIP31B	3-873
NSP596		TIP32B	3-873
NSP597		TIP31B	3-873
NSP5974		TIP42B	3-883
NSP5975		TIP42B	3-883
NSP5976		TIP42B	3-883
NSP5977		TIP41B	3-883
NSP5978		TIP41B	3-883
NSP5979		TIP41B	3-883
NSP598		TIP32B	3-873
NSP5980		2N6490	3-132
NSP5981		2N6490	3-132
NSP5982		2N6491	3-132
NSP5983		2N6487	3-132
NSP5984		2N6487	3-132
NSP5985		2N6488	3-132
NSP599		TIP31B	3-873
NSP600		TIP32B	3-873
NSP695		TIP120	3-900
NSP695A		TIP101	3-891
NSP696		TIP125	3-900
NSP696A		TIP106	3-891
NSP697		TIP120	3-900
NSP697A		TIP101	3-891
NSP698		TIP125	3-900
NSP698A		TIP106	3-891
NSP699		TIP121	3-900
NSP699A		TIP101	3-891

Industry Part Number	Motorola Nearest Replacement	Motorola Similar Replacement	Page Number
NSP700		TIP126	3-900
NSP700A		TIP106	3-891
NSP701		TIP122	3-900
NSP702		TIP127	3-900
PMD10K-100		2N6059	3-93
PMD10K-40		2N6059	3-93
PMD10K-60		2N6059	3-93
PMD10K-80		2N6059	3-93
PMD11K-100		2N6052	3-93
PMD11K-40		2N6052	3-93
PMD11K-60		2N6052	3-93
PMD11K-80		2N6052	3-93
PMD12K-100		2N6059	3-93
PMD12K-40		MJ1000	3-423
PMD12K-60		MJ1000	3-423
PMD12K-80		MJ1001	3-423
PMD13K-100		2N6052	3-93
PMD1600K		2N6283	3-112
PMD1601K		2N6283	3-112
PMD1602K		2N6283	3-112
PMD1603K		2N6284	3-112
PMD16K-100		2N6284	3-112
PMD16K-40		2N6283	3-112
PMD16K-60		2N6283	3-112
PMD16K-80		2N6283	3-112
PMD1700K		2N6286	3-112
PMD1701K		2N6286	3-112
PMD1702K		2N6286	3-112
PMD1703K		2N6287	3-112
PMD17K-100		2N6287	3-112
PMD17K-40		2N6286	3-112
PMD17K-60		2N6284	3-112
PMD17K-80		2N6286	3-112
PMD20K-120		2N6578	3-144
PMD25K-120		2N6578	3-144
RCA1000		MJ1000	3-423
RCA1001		MJ1001	3-423
RCA120		TIP120	3-900
RCA121		TIP121	3-900
RCA122		TIP122	3-900
RCA125		TIP125	3-900
RCA126		TIP126	3-900
RCA1B01		2N5878	3-74
RCA1B04		MJ15024	3-506
RCA1B05		MJ15024	3-506
RCA1B06		MJ15003	3-500
RCA1B09		MJ15024	3-506
RCA1C03		MJE15028	3-684
RCA1C04		MJE15029	3-684
RCA1C05		TIP41B	3-883
RCA1C06		TIP42C	3-883
RCA1C07		MJE3055T	3-628
RCA1C08		MJE2955T	3-628
RCA1C09		MJE3055T	3-628
RCA1C10		2N6292	3-101
RCA1C11		2N6107	3-101
RCA1C12		MJE15028	3-684
RCA1C13		MJE15029	3-684
RCA1C14		2N6290	—
RCA1C15		2N6388	3-124
RCA1C16		2N6668	3-147
RCA29		TIP31B	3-873
RCA29A		TIP31B	3-873

INDEX AND CROSS REFERENCE (continued)

Industry Part Number	Motorola Nearest Replacement	Motorola Similar Replacement	Page Number
RCA29B		TIP31B	3-873
RCA29C		TIP31C	3-873
RCA30		TIP32B	3-873
RCA3054		TIP31B	3-873
RCA3055		2N6487	3-132
RCA30A		TIP32B	3-873
RCA30B		TIP32B	3-873
RCA30C		TIP32C	3-873
RCA31		TIP31B	3-873
RCA31A		TIP31B	3-873
RCA31B		TIP31B	3-873
RCA31C		TIP31C	3-873
RCA32		TIP32B	3-873
RCA32A		TIP32B	3-873
RCA32B		TIP32B	3-873
RCA32C		TIP32C	3-873
RCA3441		MJE15030	3-684
RCA41		TIP41B	3-883
RCA410		MJ410	3-417
RCA411		MJ423	3-419
RCA413		MJ413	3-419
RCA41A		TIP41B	3-883
RCA41B		TIP41B	3-883
RCA41C		TIP41C	3-883
RCA42		TIP42B	3-883
RCA423		MJ423	3-419
RCA42A		TIP42B	3-883
RCA42B		TIP42B	3-883
RCA42C		TIP42C	3-883
RCA431		MJ423	3-419
RCA6263		MJE15030	3-684
RCA8203		TIP106	3-891
RCA8203A		2N6667	3-147
RCA8203B		2N6668	3-147
RCA8350		MJ2501	3-425
RCA8766		MJ10007	3-445
RCA8766A		MJ10007	3-445
RCA8766B		MJ10007	3-445
RCA8766C		MJ10007	3-445
RCA8766D		MJ10007	3-445
RCA8766E		MJ10007	3-445
RCA8767		2N6547	3-140
RCA8767A		2N6547	3-140
RCA8767B		2N6547	3-140
RCA9113		2N6547	3-140
RCA9113A		2N6547	3-140
RCA9113B		2N6547	3-140
RCP111A		MJE340	3-602
RCP111B		MJE340	3-602
RCP111C		MJE340	3-602
RCP111D		MJE340	3-602
RCP113A		MJE340	3-602
RCP113B		MJE340	3-602
RCP113C		MJE340	3-602
RCP113D		MJE340	3-602
RCP115		MJE341	3-604
RCP115B		MJE340	3-602
RCP117		MJE341	3-604
RCP117B		MJE340	3-602
RCP131A		MJE344	3-604
RCP131B		MJE344	3-604
RCP131C		MJE340	3-602
RCP131D		MJE340	3-602

Industry Part Number	Motorola Nearest Replacement	Motorola Similar Replacement	Page Number
RCP133A		MJE344	3-604
RCP133B		MJE344	3-604
RCP133C		MJE340	3-602
RCP133D		MJE340	3-602
RCP135		2N4923	3-38
RCP135B		MJE340	3-602
RCP137		2N4923	3-38
RCP137B		MJE340	3-602
RCS617		2N5882	3-77
RCS618		2N5880	3-77
SDM20301		2N6283	3-112
SDM20302		2N6283	3-112
SDM20303		2N6283	3-112
SDM20304		2N6286	3-112
SDM20311		2N6283	3-112
SDM20312		2N6283	3-112
SDM20313		2N6283	3-112
SDM20314		2N6286	3-112
SDM20321		2N6283	3-112
SDM20322		2N6283	3-112
SDM20323		2N6283	3-112
SDM20324		2N6286	3-112
SDM21301		2N6286	3-112
SDM21302		2N6286	3-112
SDM21303		2N6286	3-112
SDM21304		2N6287	3-112
SDM21311		2N6286	3-112
SDM21312		2N6286	3-112
SDM21313		2N6286	3-112
SDM21314		2N6287	3-112
SDM6000		MJ10012	3-457
SDM6001		MJ10012	3-457
SDM6002		MJ10012	3-457
SDM6003		MJ10012	3-457
SDN1010		2N6056	3-97
SDN1020		MJ3001	3-425
SDN4040		MJ10000	3-433
SDN4045		MJ10000	3-433
SDN6000		MJ10000	3-433
SDN6001		MJ10000	3-433
SDN6060		MJ10000	3-433
SDN6061		MJ10000	3-433
SDN6062		MJ10000	3-433
SDN6251		MJ10007	3-445
SDN6252		MJ10007	3-445
SDN6253		MJ10007	3-445
SDT1056		BUX48A	3-401
SDT1057		BUX48A	3-401
SDT1058		BUX48A	3-401
SDT1059		BUX48A	3-401
SDT1061		BUX48A	3-401
SDT1062		BUX48A	3-401
SDT1063		BUX48A	3-401
SDT1064		BUX48A	3-401
SDT13301		2N6547	3-140
SDT13302		2N6547	3-140
SDT13303		2N6547	3-140
SDT13304		MJ16010	3-512
SDT410		MJ410	3-417
SDT411		MJ423	3-419
SDT413		MJ413	3-419
SDT423		MJ423	3-419
SDT425		BUX48A	3-401

INDEX AND CROSS REFERENCE (continued)

Industry Part Number	Motorola Nearest Replacement	Motorola Similar Replacement	Page Number
SDT431		MJ423	3-419
SDT5101		TIP41B	3-883
SDT5102		TIP41B	3-883
SDT5103		TIP41B	3-883
SDT5111		TIP42B	3-883
SDT5112		TIP42B	3-883
SDT5113		TIP42B	3-883
SDT7206		2N6341	3-117
SDT7603		2N6338	3-117
SDT7604		2N6339	3-117
SDT7605		2N6341	3-117
SDT7609		2N6338	3-117
SDT7610		2N6339	3-117
SDT7611		2N6341	3-117
SDT7612		BUV23	3-388
SDT7731		2N5882	3-77
SDT7732		2N5882	3-77
SDT7733		2N5882	3-77
SDT7734		2N5629	—
SDT7735		2N5631	3-59
SDT7736		2N5631	3-59
SDT9201		2N3055	3-2
SDT9202		2N5878	3-74
SDT9205		2N3055	3-2
SDT9206		2N3055	3-2
SDT9207		2N5878	3-74
SDT9208		2N5882	3-77
SDT9209		MJ15001	3-497
SDT9210		2N3055	3-2
SDT9307		2N3716	3-12
SDT9308		2N3716	3-12
SDT9309		2N3716	3-12
SDT9701		2N5303	3-54
SDT9702		2N5629	—
SDT9703		2N5631	3-59
SDT9704		2N5882	3-77
SDT9705		2N5629	—
SDT9706		2N5631	3-59
SDT9707		2N3055	3-2
SE9300		2N6387	3-124
SE9301		2N6388	3-124
SE9302		BDX33C	3-217
SE9303		MJ1000	3-423
SE9304		MJ1001	3-423
SE9306		2N6287	3-112
SE9307		2N6283	3-112
SE9308		2N6286	3-112
SE9400		2N6667	3-147
SE9401		2N6668	3-147
SE9402		BDX34C	3-217
SE9406		2N6286	3-112
SE9407		2N6286	3-112
SE9408		2N6287	3-112
SGSF564		MJ16018	3-520
SV7056		MJE340	3-602
SVT100-5C		2N5882	3-77
SVT200-10C		MJ15024	3-506
SVT250-10C		MJ15024	3-506
SVT300-10C		MJ16110	3-529
SVT350-12		2N6547	3-140
SVT350-3		BUX48A	3-401
SVT350-5C		MJE16106	3-696
SVT400-12		MJ16110	3-529

Industry Part Number	Motorola Nearest Replacement	Motorola Similar Replacement	Page Number
SVT400-3		BUX48A	3-401
SVT400-5C		BUX48A	3-401
SVT450-3		BUX48A	3-401
SVT450-5C		MJE16106	3-696
SVT6000		MJ10005	3-439
SVT6001		MJ10005	3-439
SVT6002		MJ10005	3-439
SVT6060		MJ10005	3-439
SVT6061		MJ10005	3-439
SVT6062		MJ10005	3-439
SVT6251		MJ10007	3-445
SVT6252		MJ10007	3-445
SVT6253		MJ10007	3-445
SVT6546		MJ16110	3-529
SVT6547		MJ16110	3-529
SVT7531		MJE16106	3-696
SVT7533		MJE16106	3-696
SVT7534		MJE16106	3-696
SVT7543		MJE16106	3-696
SVT7544		MJE16106	3-696
SVT7550		MJ16010	3-512
SVT7551		MJ16010	3-512
SVT7552		MJ16010	3-512
SVT7553		MJ16110	3-529
SVT7554		MJ16010	3-512
SVT7555		MJ16010	3-512
SVT7560		MJ16010	3-512
SVT7561		MJ16012	3-512
SVT7563		MJ16110	3-529
SVT7564		MJ16110	3-529
SVT7565		MJ16110	3-529
SVT7570		MJ16010	3-512
SVT7571		MJ16012	3-512
SVT7573		MJ16110	3-529
SVT7574		MJ16110	3-529
SVT7575		MJ16012	3-512
TIP100	TIP101		3-891
TIP101	TIP101		3-891
TIP102	TIP102		3-891
TIP105	TIP106		3-891
TIP106	TIP106		3-891
TIP107	TIP107		3-891
TIP110	TIP111		3-895
TIP111	TIP111		3-895
TIP112	TIP112		3-895
TIP115	TIP116		3-895
TIP116	TIP116		3-895
TIP117	TIP117		3-895
TIP120	TIP120		3-900
TIP121	TIP121		3-900
TIP122	TIP122		3-900
TIP125	TIP125		3-900
TIP126	TIP126		3-900
TIP127	TIP127		3-900
TIP140	TIP141		3-904
TIP140T		TIP101	3-891
TIP141	TIP141		3-904
TIP141T		TIP101	3-891
TIP142	TIP142		3-904
TIP142T		TIP102	3-891
TIP145	TIP146		3-904
TIP145T		TIP106	3-891
TIP146	TIP146		3-904

INDEX AND CROSS REFERENCE (continued)

Industry Part Number	Motorola Nearest Replacement	Motorola Similar Replacement	Page Number	
TIP146T	TIP147	TIP106	3-891	
TIP147		3-904		
TIP147T		TIP107	3-891	
TIP150		MJE13007	3-667	
TIP151		MJE13007	3-667	
TIP152		MJE13007	3-667	
TIP160		MJE5742	3-640	
TIP161	TIP29C	MJE5742	3-640	
TIP162		MJE5742	3-640	
TIP29		3-871		
TIP2955		TIP2955	3-908	
TIP29A		TIP29C	3-871	
TIP29B		TIP29C	3-871	
TIP29C		TIP29C	3-871	
TIP29D		TIP30C	MJE15030	3-684
TIP29E			MJE15030	3-684
TIP29F			MJE15030	3-684
TIP30	3-871			
TIP3055	TIP3055		3-908	
TIP30A	TIP30C		3-871	
TIP30B	TIP30C		3-871	
TIP30C	TIP30C	3-871		
TIP30D	TIP31B	MJE15031	3-684	
TIP30E		MJE15031	3-684	
TIP30F		MJE15031	3-684	
TIP31		3-873		
TIP31A	TIP31B	3-873		
TIP31B	TIP31B	3-873		
TIP31C	TIP31C	3-873		
TIP31D	TIP32B	MJE15030	3-684	
TIP31E		MJE15030	3-684	
TIP31F		MJE15030	3-684	
TIP32		3-873		
TIP32A	TIP32B	3-873		
TIP32B	TIP32B	3-873		
TIP32C	TIP32C	3-873		
TIP32D	TIP33C	MJE15031	3-684	
TIP32E		MJE15031	3-684	
TIP32F		MJE15031	3-684	
TIP33C		3-877		
TIP35A	TIP35B	3-879		
TIP35C	TIP35C	3-879		
TIP36A	TIP36B	3-879		
TIP36C	TIP36C	3-879		
TIP41	TIP41B	3-883		
TIP41A	TIP41B	3-883		
TIP41B	TIP41B	3-883		
TIP41C	TIP41C	3-883		
TIP41D	TIP42B	MJE15030	3-684	
TIP41E		MJE15030	3-684	
TIP41F		MJE15030	3-684	
TIP42		3-883		
TIP42A		TIP42B	3-883	
TIP42B		TIP42B	3-883	
TIP42C		TIP42C	3-883	
TIP42D	MJE15031	3-684		
TIP42E	TIP47	MJE15031	3-684	
TIP42F		MJE15031	3-684	
TIP47		3-887		
TIP48		TIP48	3-887	
TIP49		TIP49	3-887	
TIP50		TIP50	3-887	
TIP510		MJ15011	3-502	

Industry Part Number	Motorola Nearest Replacement	Motorola Similar Replacement	Page Number
TIP511		MJ15011	3-502
TIP512		MJ15011	3-502
TIP513		MJ15012	3-502
TIP514		MJE15030	3-684
TIP517		2N6339	3-117
TIP518		2N6341	3-117
TIP519		MJ15012	3-502
TIP520		MJ15012	3-502
TIP523		MJ15012	3-502
TIP524		2N6497	3-136
TIP525	MJ15011	3-502	
TIP526	MJ15011	3-502	
TIP527	MJ15012	3-502	
TIP528	MJ15012	3-502	
TIP545	TIP47 TIP48	MJ15016	3-5
TIP546		MJ15016	3-5
TIP550		BU208A	3-226
TIP551		BU208A	3-226
TIP552		BU208A	3-226
TIP553		BU208A	3-226
TIP554		MJE16106	3-696
TIP555		MJE16106	3-696
TIP556		MJE16106	3-696
TIP562		MJ16012	3-512
TIP563	MJ16012	3-512	
TIP565	MJ10009	3-451	
TIP575	MJE16106	3-696	
TIP575A	MJE16106	3-696	
TIP575B	MJE16106	3-696	
TIP575C	MJE16106	3-696	
TIP600	TIP101	3-891	
TIP601	TIP101	3-891	
TIP602	TIP102	3-891	
TIP605	TIP106	3-891	
TIP606	TIP106	3-891	
TIP607	TIP107	3-891	
TIP61	TIP31C	3-873	
TIP61A	TIP31C	3-873	
TIP61B	TIP31C	3-873	
TIP61C	TIP31C	3-873	
TIP62	TIP32C	3-873	
TIP620	TIP120	3-900	
TIP621	TIP121	3-900	
TIP622	TIP122	3-900	
TIP625	TIP125	3-900	
TIP626	TIP126	3-900	
TIP627	TIP127	3-900	
TIP62A	TIP32C	3-873	
TIP62B	TIP32C	3-873	
TIP62C	TIP32C	3-873	
TIP63	TIP47 TIP48	TIP63	3-887
TIP64		TIP64	3-887
TIP640		MJ3001	3-425
TIP641		MJ3001	3-425
TIP660		MJ10007	3-445
TIP661		MJ10007	3-445
TIP662		MJ10007	3-445
TIP665	MJ10009	3-451	
TIP666	MJ10007	3-445	
TIP667	MJ10007	3-445	
TIP701	MJE16106	3-696	
TIP73	TIP48	3-887	
TIP73A	2N6487	3-132	

INDEX AND CROSS REFERENCE (continued)

Industry Part Number	Motorola Nearest Replacement	Motorola Similar Replacement	Page Number
TIP73B		2N6488	3-132
TIP74		2N6490	3-132
TIP74A		2N6490	3-132
TIP74B		2N6491	3-132
TIP75		MJE13005	3-661
TIP75A		MJE13005	3-661
TIP75B		MJE13005	3-661
TIP75C		MJE13005	3-661

Industry Part Number	Motorola Nearest Replacement	Motorola Similar Replacement	Page Number
TIPL752		MJE16106	3-696
TIPL752A		MJE16106	3-696
TIPL753		MJE16106	3-696
TIPL753A		MJE16106	3-696
TIPL755		MJ16110	3-529
TIPL755A		MJ16010	3-512
TIPL760		MJE16002	3-688
TIPL760A		MJE16002	3-688